



US00D750000S

(12) **United States Design Patent**
Han et al.

(10) **Patent No.:** **US D750,000 S**
(45) **Date of Patent:** **** Feb. 23, 2016**

- (54) **FRONT BUMPER COVER FOR AUTOMOBILES**
- (71) Applicant: **Hyundai Motor Company**, Seoul (KR)
- (72) Inventors: **Ju-Wan Han**, Seoul (KR); **Hee-Joon An**, Gyeonggi-Do (KR)
- (73) Assignee: **Hyundai Motor Company**, Seoul (KR)
- (**) Term: **14 Years**
- (21) Appl. No.: **29/516,240**
- (22) Filed: **Jan. 30, 2015**

- (30) **Foreign Application Priority Data**
Oct. 17, 2014 (KR) 30-2014-0049870
- (51) **LOC (10) Cl.** **12-16**
- (52) **U.S. Cl.**
USPC **D12/169**
- (58) **Field of Classification Search**
USPC D12/169, 216, 90-92, 86, 171, 196,
D12/163; 293/102, 113, 115, 117, 120;
296/180.1, 180.2
CPC . B60R 19/52; B60R 2019/25; B62D 25/0845
See application file for complete search history.

- (56) **References Cited**
U.S. PATENT DOCUMENTS
D617,700 S * 6/2010 Nishio D12/169
D664,901 S * 8/2012 Futschik D12/169

- D670,627 S * 11/2012 Fetherston D12/169
- D686,546 S * 7/2013 Fetherston D12/169
- D698,291 S * 1/2014 Ishigaki D12/169
- D711,796 S * 8/2014 Futschik D12/169
- D717,703 S * 11/2014 Munson D12/169

* cited by examiner

Primary Examiner — Melody N Brown
(74) *Attorney, Agent, or Firm* — Mintz Levin Cohn Ferris Glovsky and Popeo, P.C.; Kongsik Kim

(57) **CLAIM**
The ornamental design for a front bumper cover for automobiles, as shown and described.

DESCRIPTION

FIG. 1 is a perspective view of a front bumper cover for automobiles according to the present invention.
FIG. 2 is a front view of the front bumper cover for automobiles of FIG. 1.
FIG. 3 is a rear view of the front bumper cover for automobiles of FIG. 1.
FIG. 4 is a left side view of the front bumper cover for automobiles of FIG. 1.
FIG. 5 is a right side view of the front bumper cover for automobiles of FIG. 1.
FIG. 6 is a top view of the front bumper cover for automobiles of FIG. 1; and,
FIG. 7 is a bottom view of the front bumper cover for automobiles of FIG. 1.

1 Claim, 7 Drawing Sheets

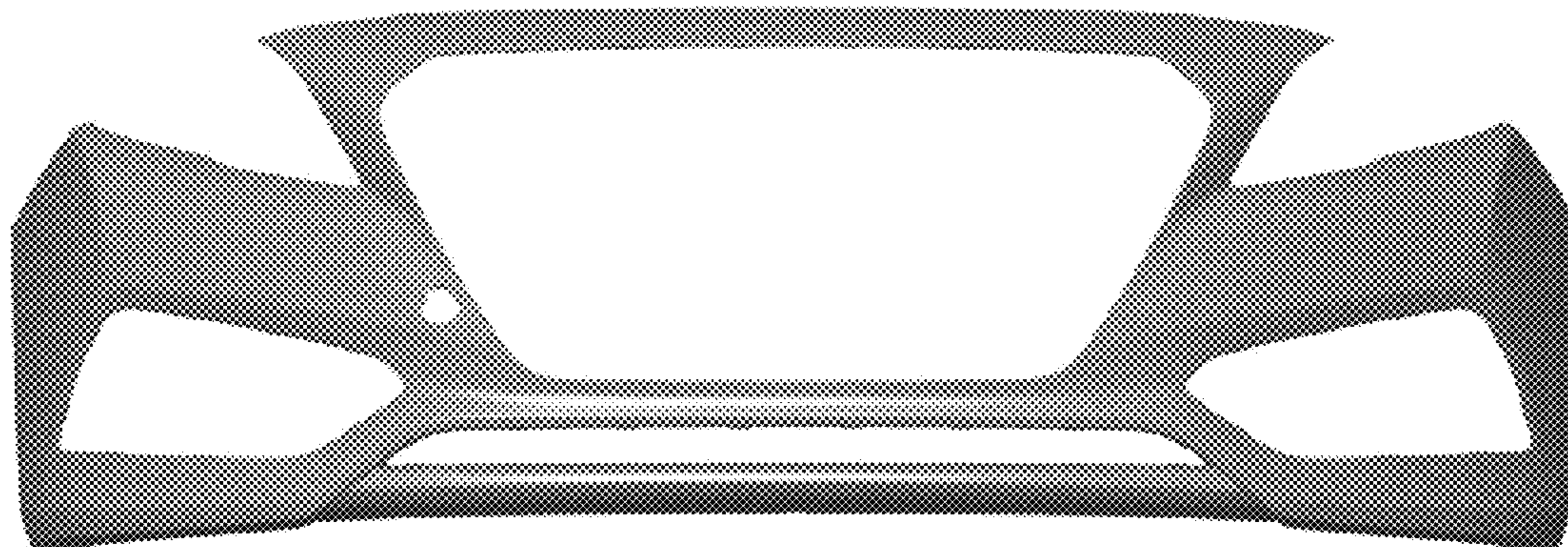

FIG. 1

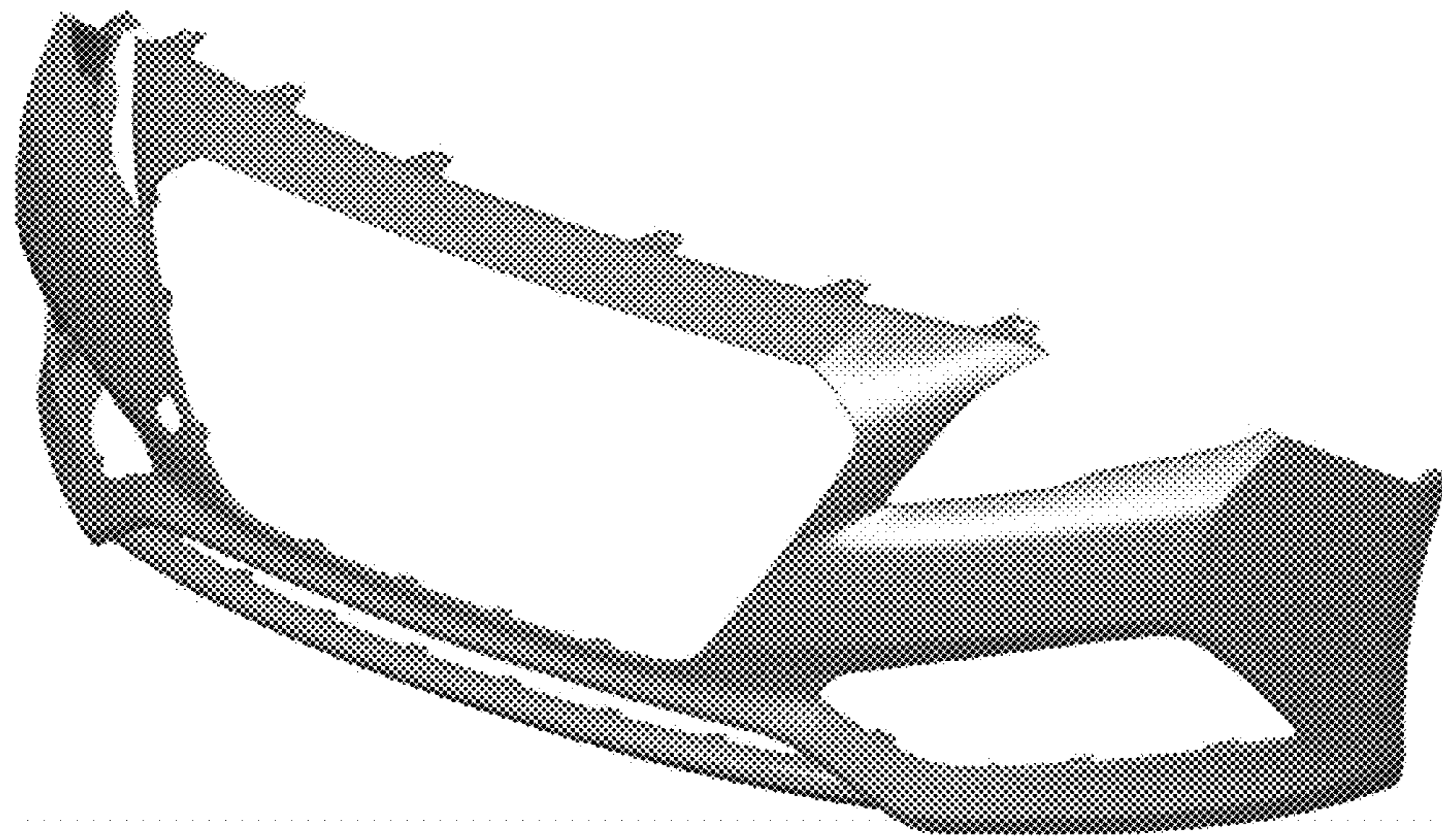

FIG. 2

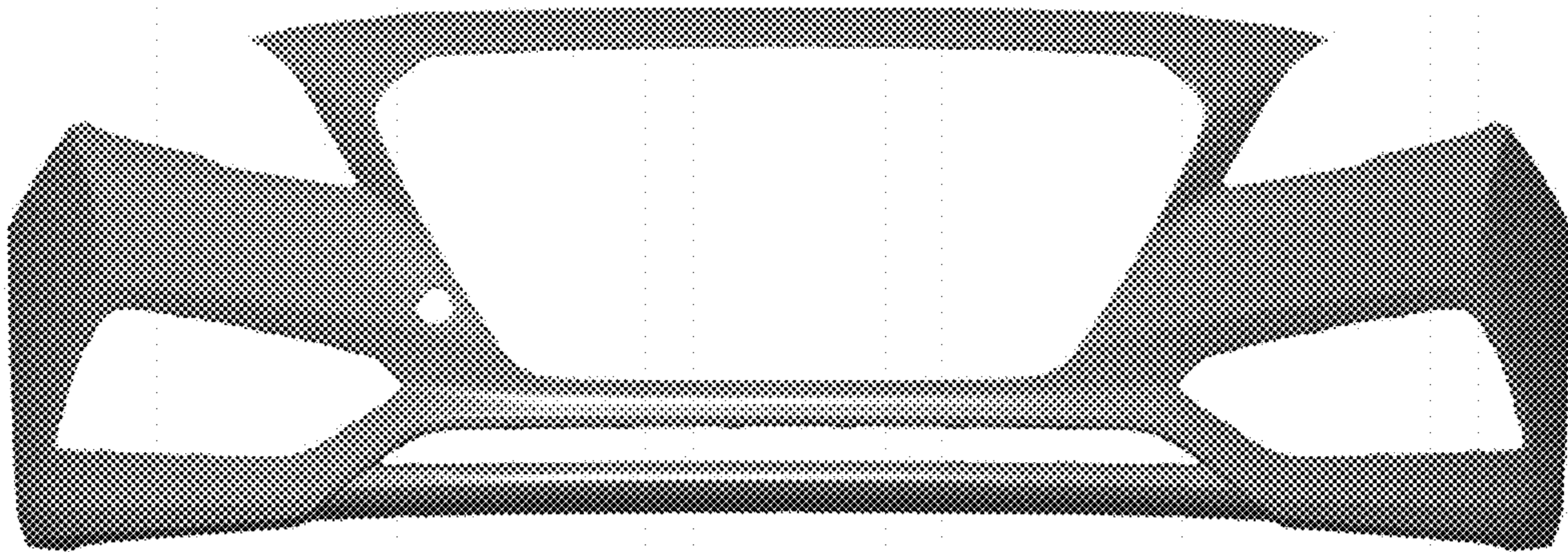

FIG. 3

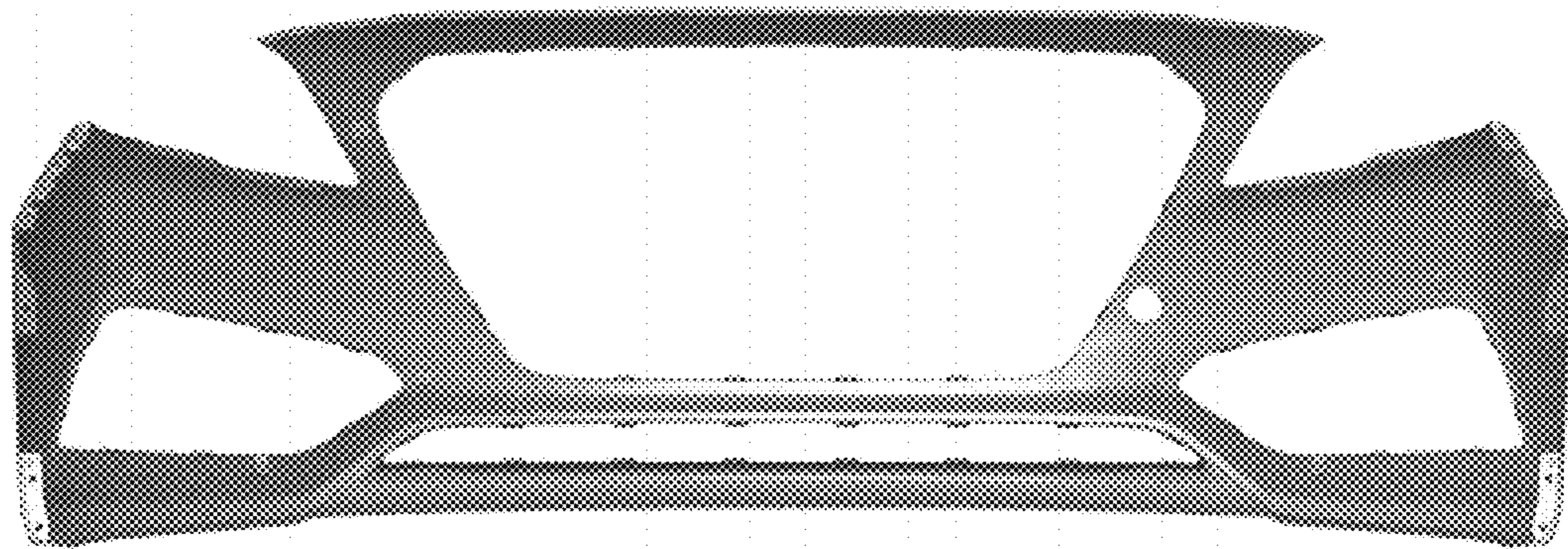

FIG. 4

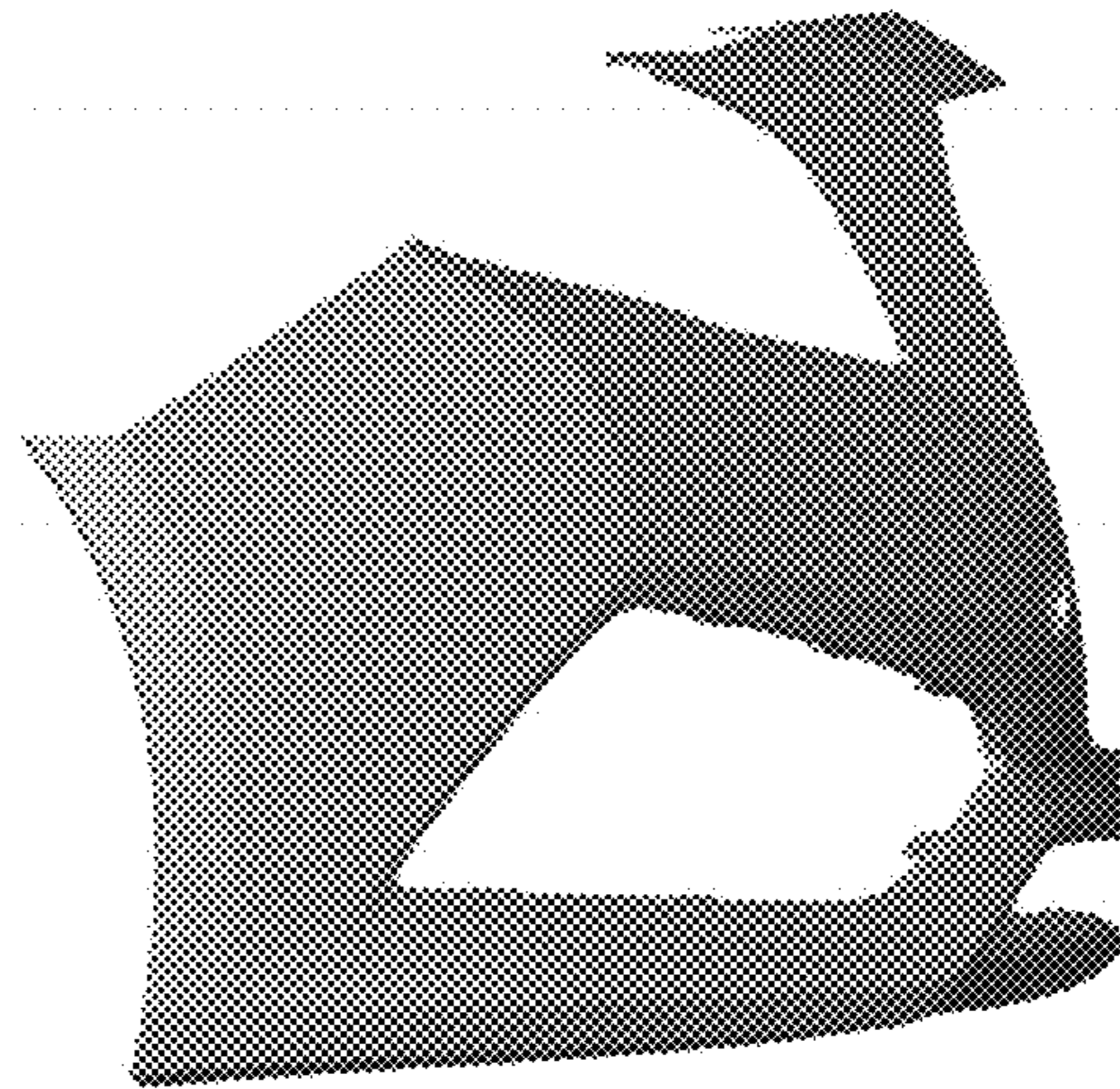

FIG. 5

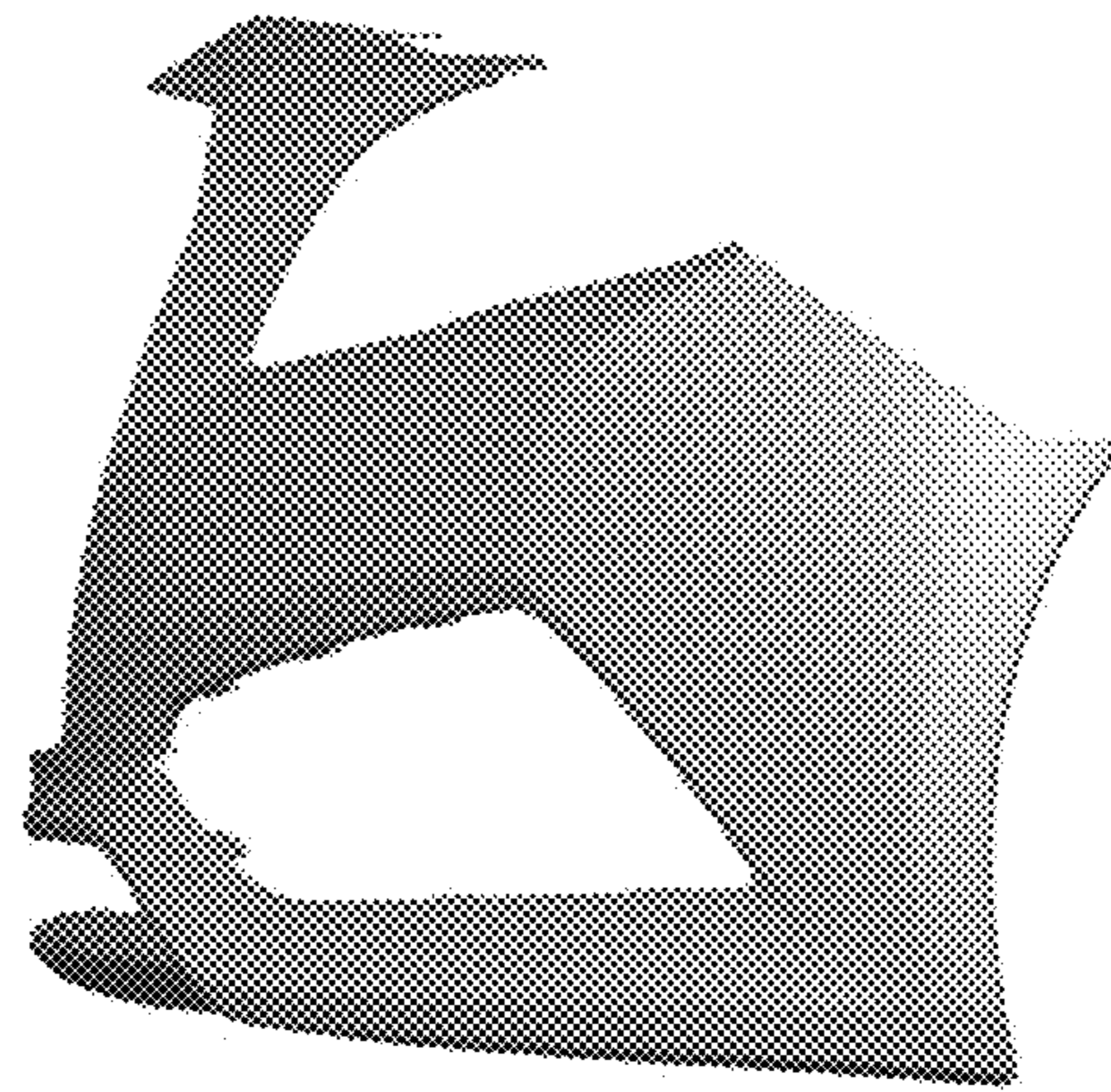

FIG. 6

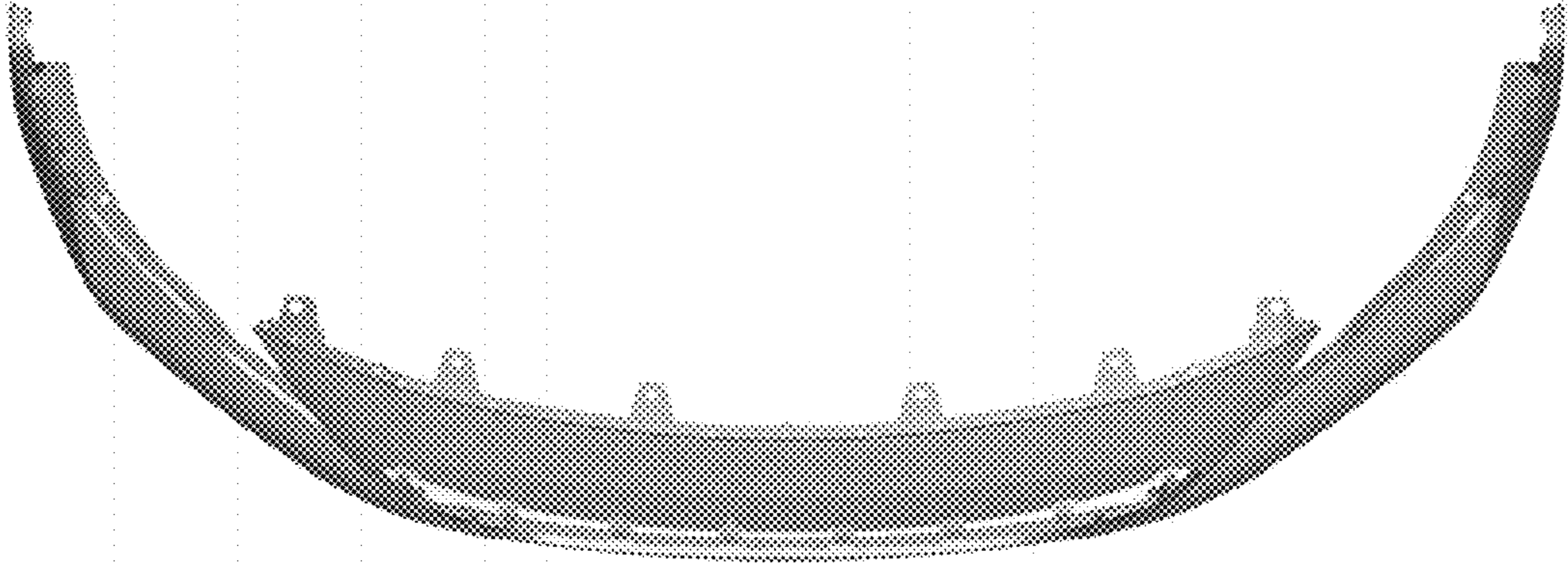

FIG. 7

