



US00D749900S

(12) **United States Design Patent**
Hyp

(10) **Patent No.:** **US D749,900 S**

(45) **Date of Patent:** **** Feb. 23, 2016**

(54) **ROTISSERIE BASKET**

(56) **References Cited**

(71) Applicant: **Euro-Pro Operating LLC**, Newton,
MA (US)

(72) Inventor: **Eric Daniel Hyp**, Yongkang (CN)

(73) Assignee: **SHARKNINJA OPERATING LLC**,
Newton, MA (US)

(**) Term: **14 Years**

(21) Appl. No.: **29/473,397**

(22) Filed: **Nov. 21, 2013**

(51) **LOC (10) Cl.** **07-02**

(52) **U.S. Cl.**
USPC **D7/402**

(58) **Field of Classification Search**
USPC D7/323, 329–332, 337, 339, 346, 347,
D7/354–363, 387, 391, 393, 395, 402, 408,
D7/409, 411, 504, 404, 637, 638, 601, 704,
D7/669, 368; 99/279, 323, 324, 325, 331,
99/332, 337–340, 355, 369, 403–419, 425,
99/426, 444, 450; D6/519, 566, 323;
220/485, 491, 573.1, 573.5, 759, 912;
211/41.2, 57.1, 74, 85.4, 106, 181.1
CPC B65D 51/247; B65D 77/245

See application file for complete search history.

U.S. PATENT DOCUMENTS

D373,039 S *	8/1996	Cohen	D6/566
D479,435 S *	9/2003	Siegel	D7/409
D612,693 S *	3/2010	Accardo	D7/409
D666,872 S *	9/2012	Maher	D7/402
D670,968 S *	11/2012	Maher	D7/403
D692,722 S *	11/2013	Maher	D7/402
D717,596 S *	11/2014	Maher	D7/402
D720,581 S *	1/2015	Puruganan	D7/704

* cited by examiner

Primary Examiner — Zenia Bennett

(74) *Attorney, Agent, or Firm* — Cantor Colburn LLP

(57) **CLAIM**

The ornamental design for a rotisserie basket, as shown and described.

DESCRIPTION

FIG. 1 is a perspective view of the rotisserie basket of this invention;
FIG. 2 is a front view of the rotisserie basket of this invention;
FIG. 3 is a rear view of the rotisserie basket of this invention;
FIG. 4 is a view of a right side of the rotisserie basket of this invention;
FIG. 5 is a view of a left side of the rotisserie basket of this invention;
FIG. 6 is a top view of the rotisserie basket of this invention;
and,
FIG. 7 is a bottom view of the rotisserie basket of this invention.

1 Claim, 5 Drawing Sheets

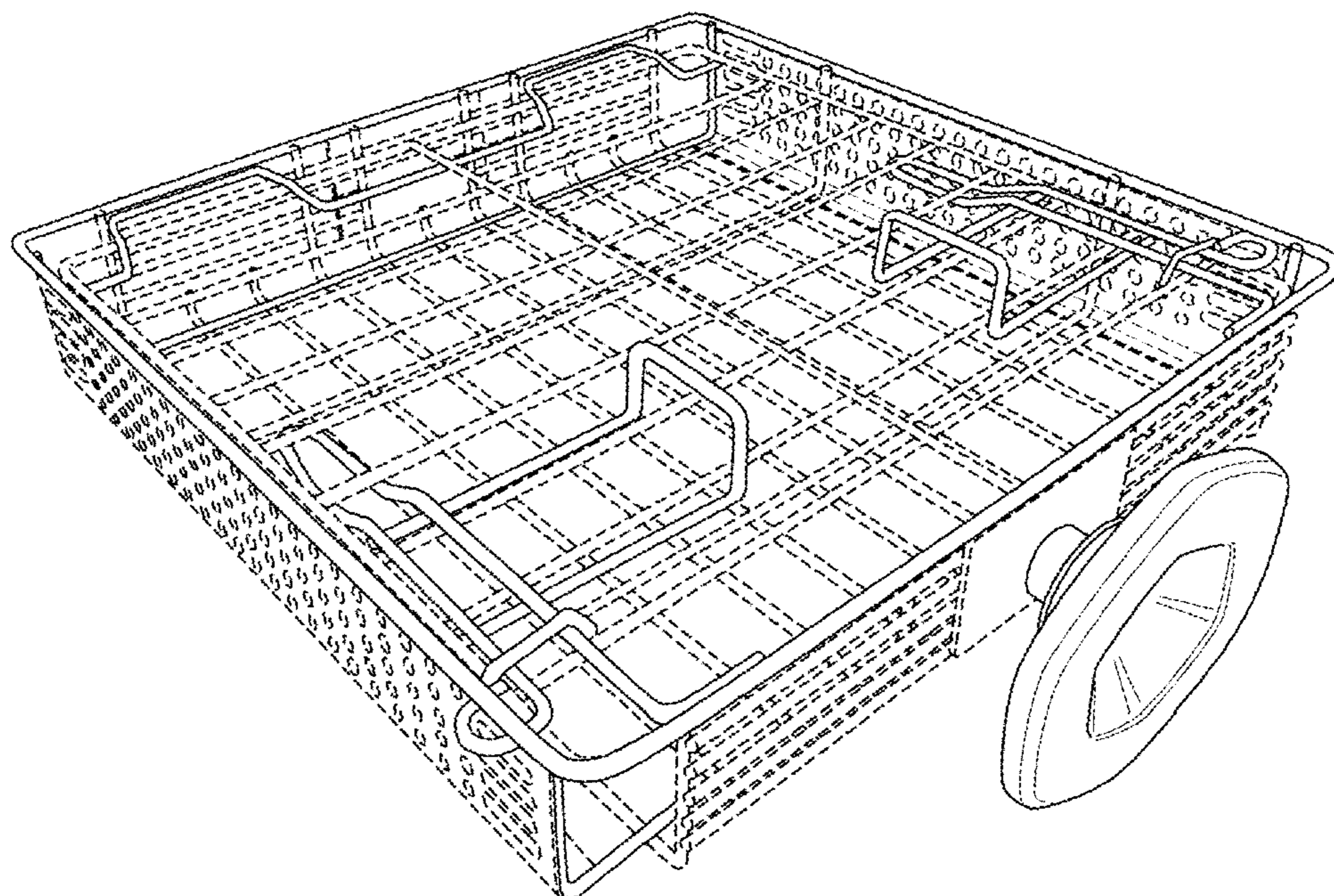

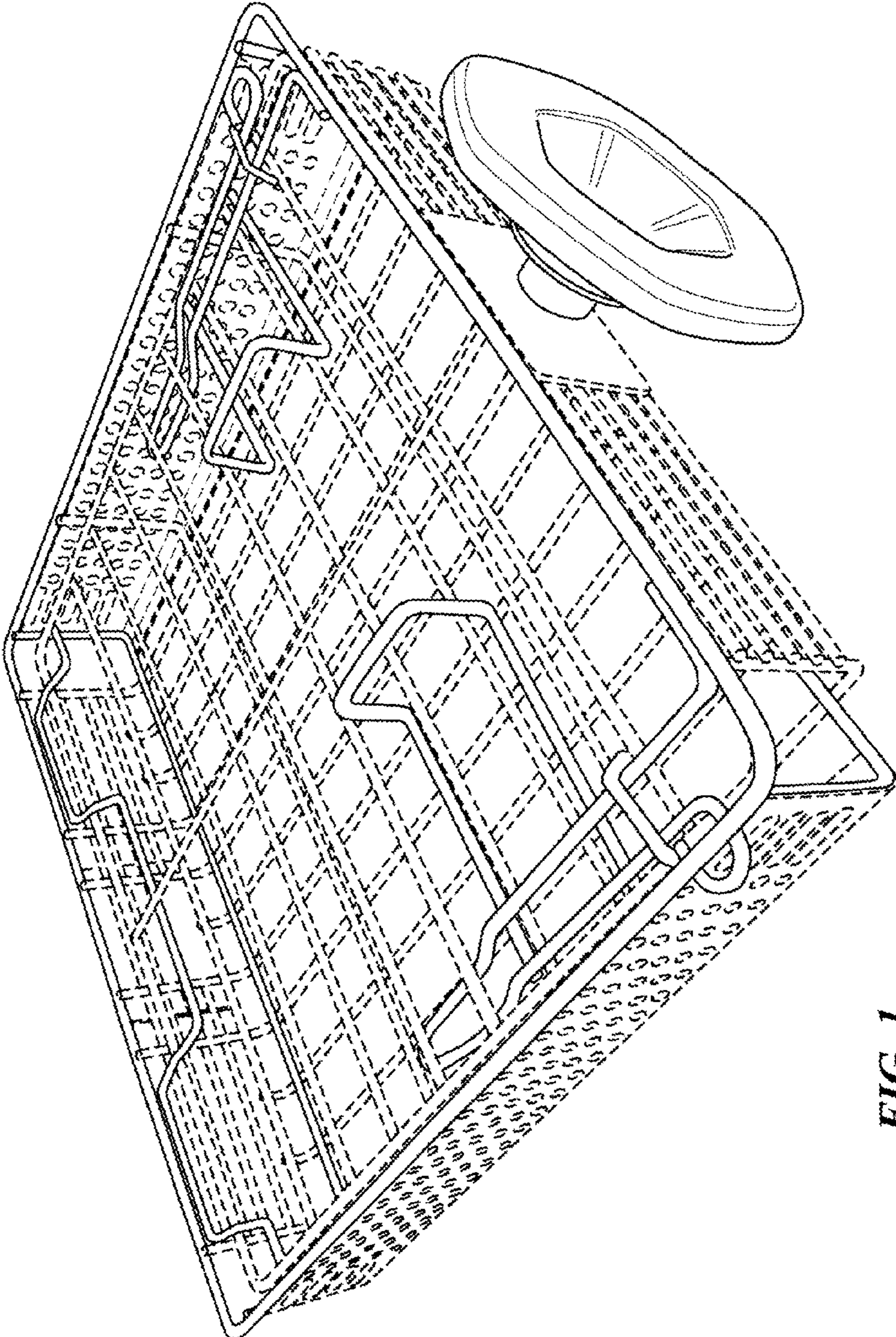

FIG. 1

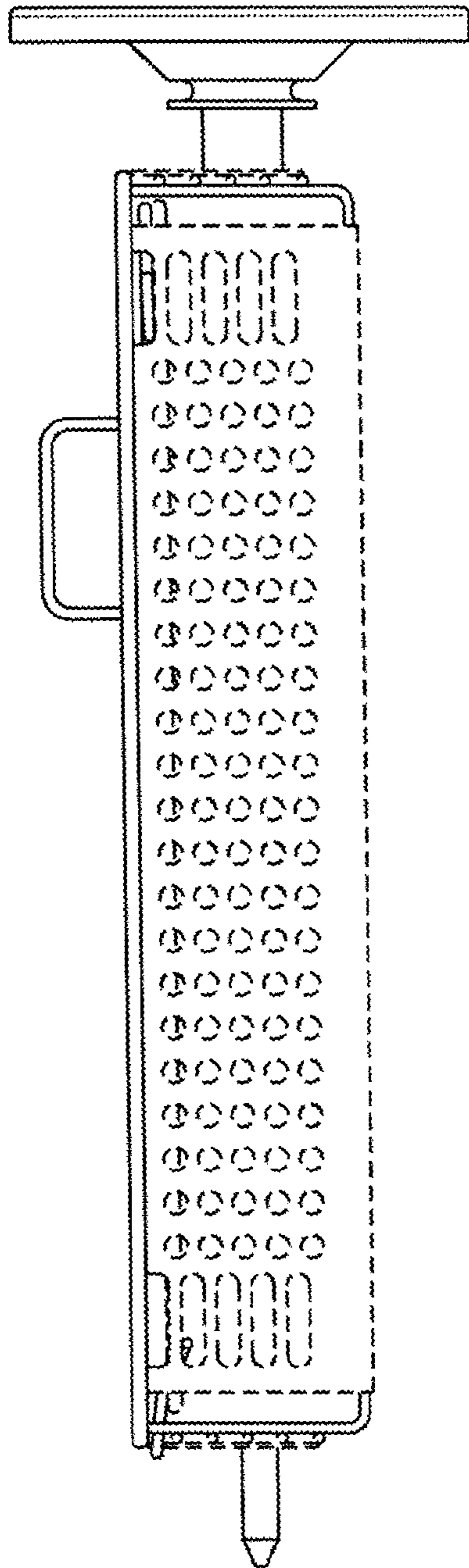

FIG. 2

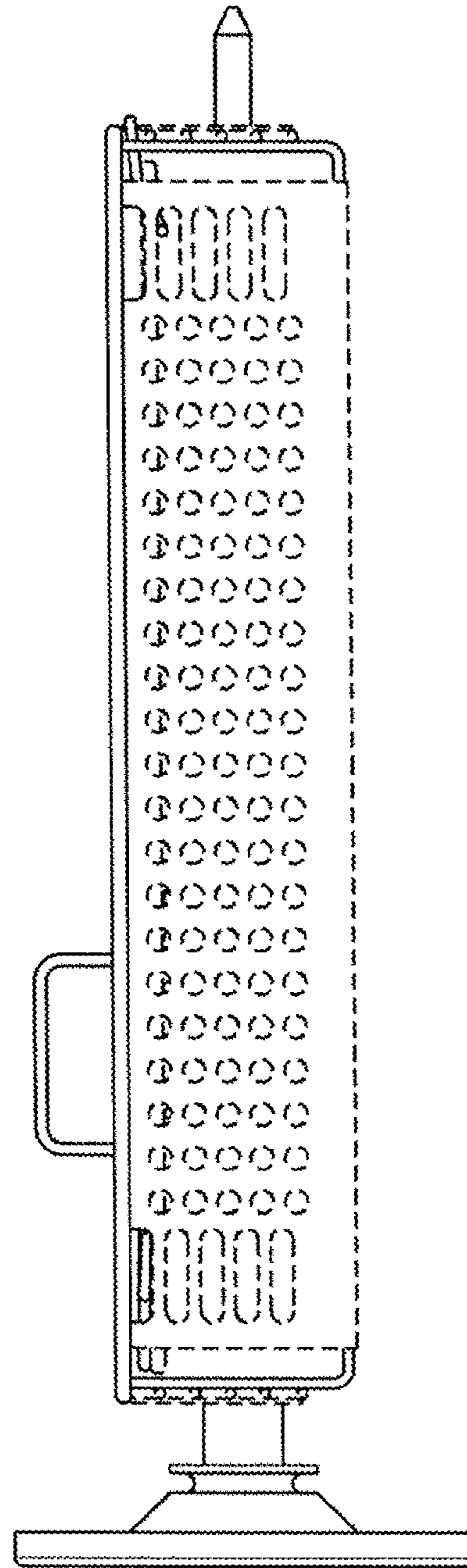

FIG. 3

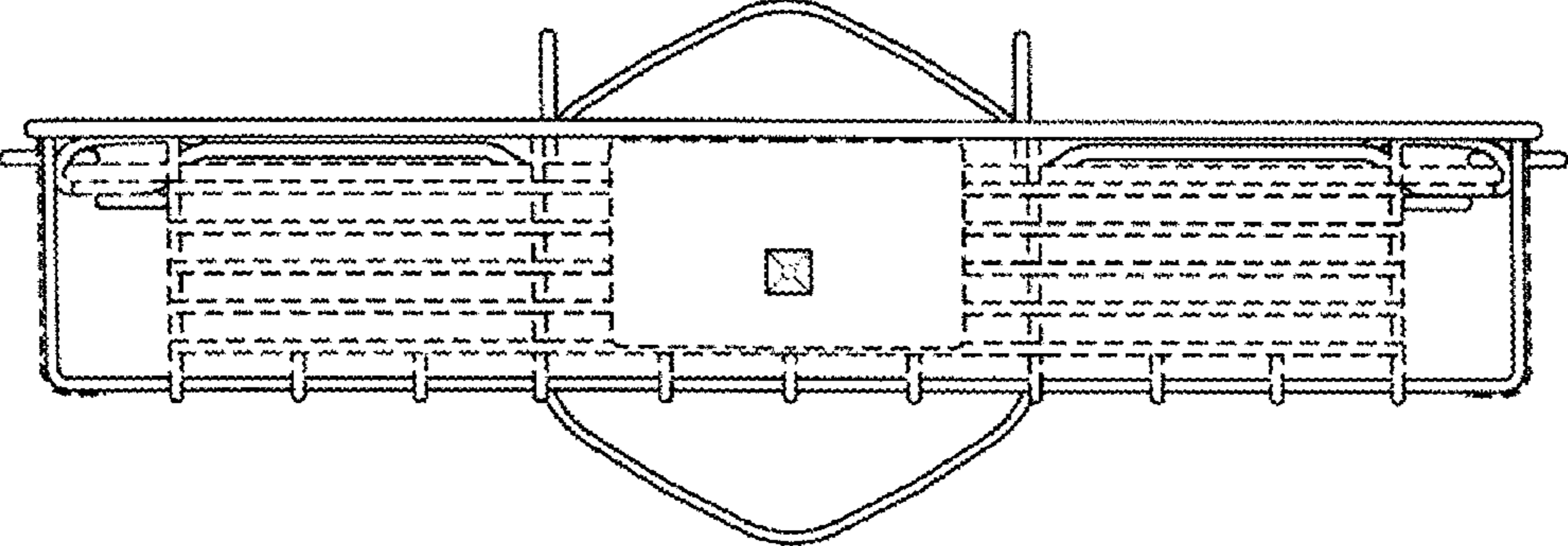

FIG. 4

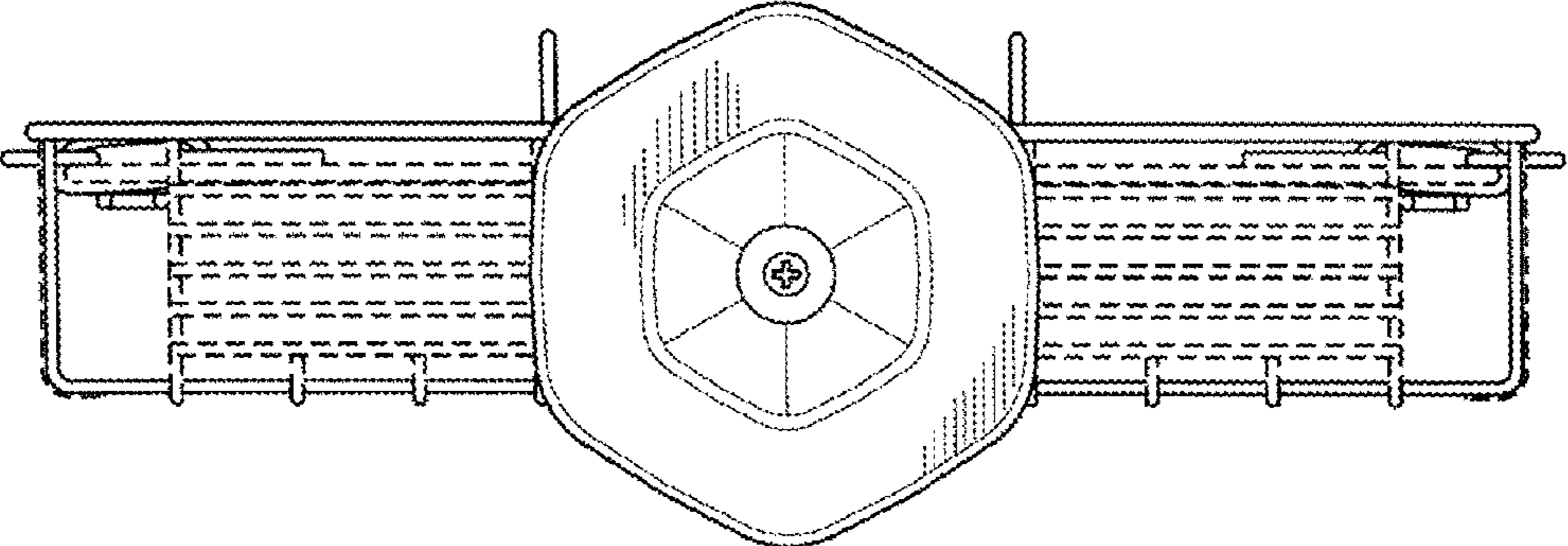

FIG. 5

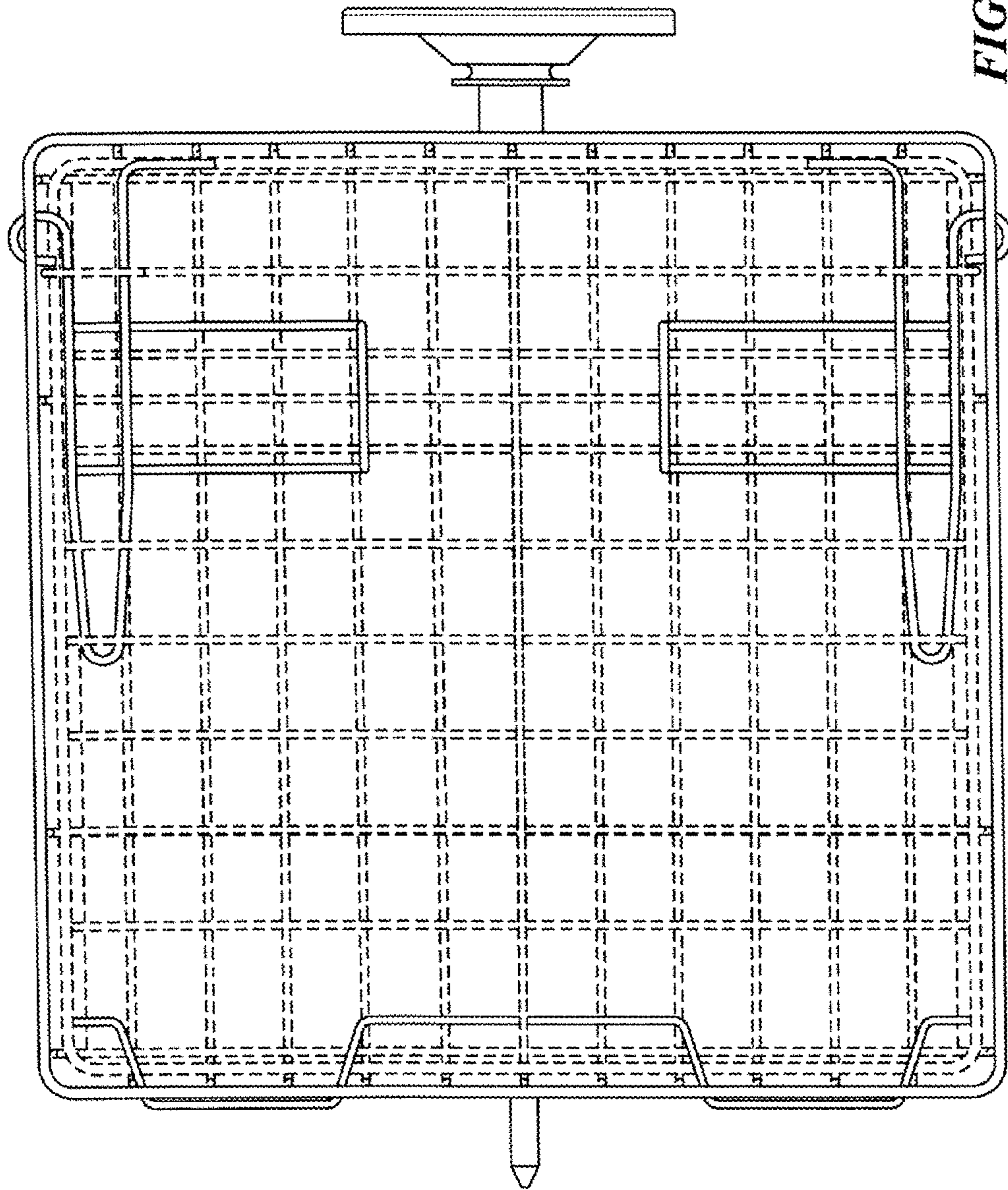

FIG. 6

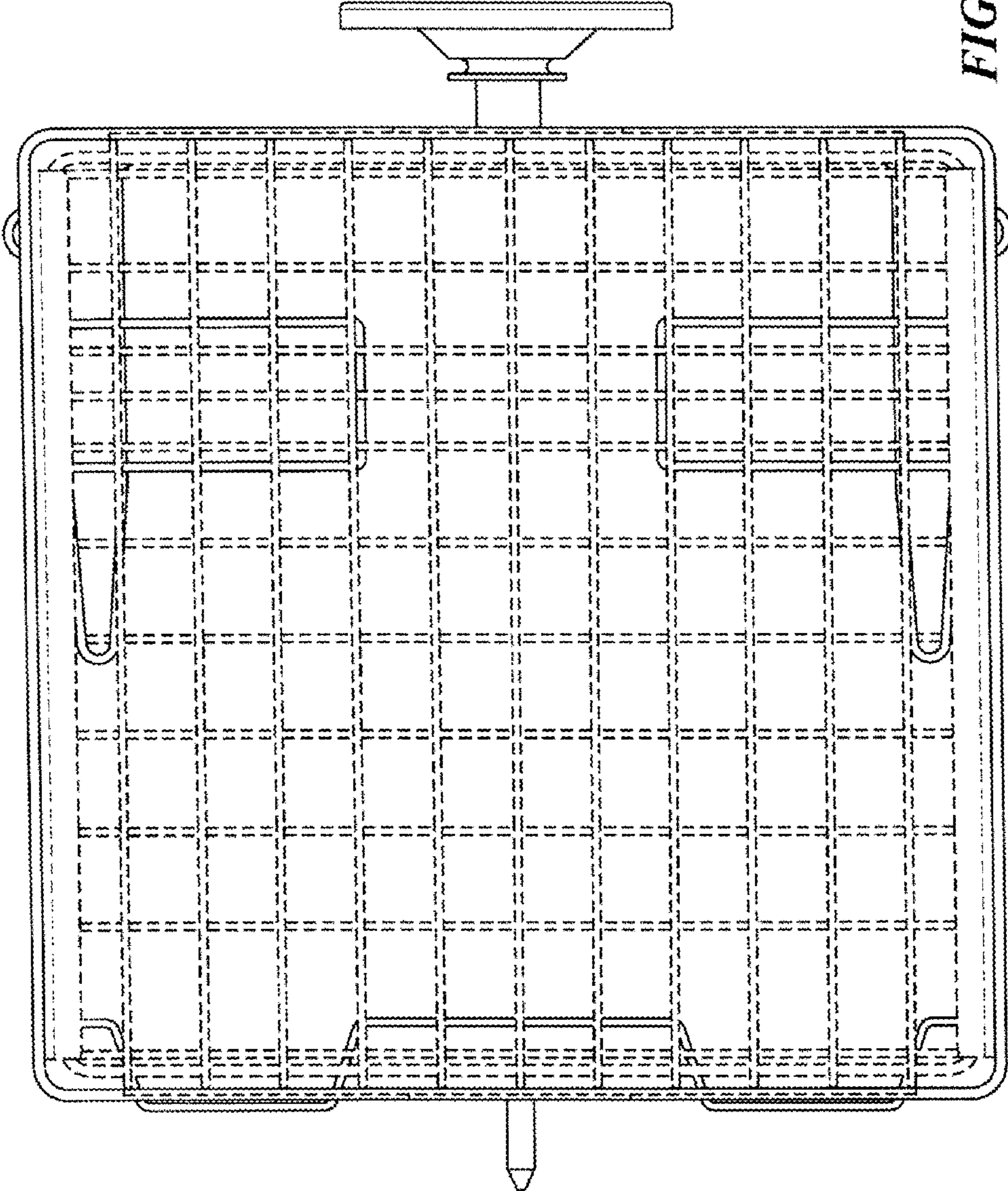

FIG. 7