



US00D749883S

(12) **United States Design Patent**  
**Garcia**

(10) **Patent No.:** **US D749,883 S**

(45) **Date of Patent:** **\*\* Feb. 23, 2016**

(54) **TABLE**

(71) Applicant: **Baker, Knapp & Tubbs, Inc.**, Hickory, NC (US)

(72) Inventor: **Jacques Garcia**, Paris (FR)

(73) Assignee: **KOHLER INTERIORS FURNITURE COMPANY**, Hickory, NC (US)

(\*\*) Term: **14 Years**

(21) Appl. No.: **29/468,436**

(22) Filed: **Sep. 30, 2013**

(51) **LOC (10) Cl.** ..... **06-06**

(52) **U.S. Cl.**  
USPC ..... **D6/696.1**

(58) **Field of Classification Search**  
USPC ..... D6/696, 696.1, 696.5, 708.17, 707.22;  
108/150, 153.1, 155, 156, 157.1, 161  
See application file for complete search history.

(56) **References Cited**

U.S. PATENT DOCUMENTS

D324,140 S *	2/1992	Kuntz	.....	D6/455
D342,843 S *	1/1994	Kuntz	.....	D6/455
D410,352 S *	6/1999	Fore	.....	D6/455
D460,641 S *	7/2002	O'Hare et al.	.....	D6/495
D495,174 S *	8/2004	Lenger	.....	D6/511
D595,968 S *	7/2009	Korban et al.	.....	D6/349

\* cited by examiner

*Primary Examiner* — Janice Seeger

(74) *Attorney, Agent, or Firm* — Foley & Lardner LLP

(57) **CLAIM**

I claim the ornamental design for a table, as shown and described.

**DESCRIPTION**

FIG. 1 is a perspective view of an exemplary embodiment of the claimed design;  
 FIG. 2 is a side view of the claimed design shown in FIG. 1;  
 FIG. 3 is another side view of the embodiment shown in FIG. 1;  
 FIG. 4 is another side view of the embodiment shown in FIG. 1;  
 FIG. 5 is another side view of the embodiment shown in FIG. 1;  
 FIG. 6 is a top view of the embodiment shown in FIG. 1;  
 FIG. 7 is a bottom view of the embodiment shown in FIG. 1;  
 FIG. 8 is a perspective view of another exemplary embodiment of the claimed design;  
 FIG. 9 is a side view of the embodiment shown in FIG. 8;  
 FIG. 10 is another side view of the embodiment shown in FIG. 8;  
 FIG. 11 is another side view of the embodiment shown in FIG. 8;  
 FIG. 12 is another side view of the embodiment shown in FIG. 8;  
 FIG. 13 is a top view of the embodiment shown in FIG. 8; and,  
 FIG. 14 is a bottom view of the embodiment shown in FIG. 8.  
 Portions shown in stipple shading as opposed to line shading illustrate contrasting surfaces.

**1 Claim, 14 Drawing Sheets**

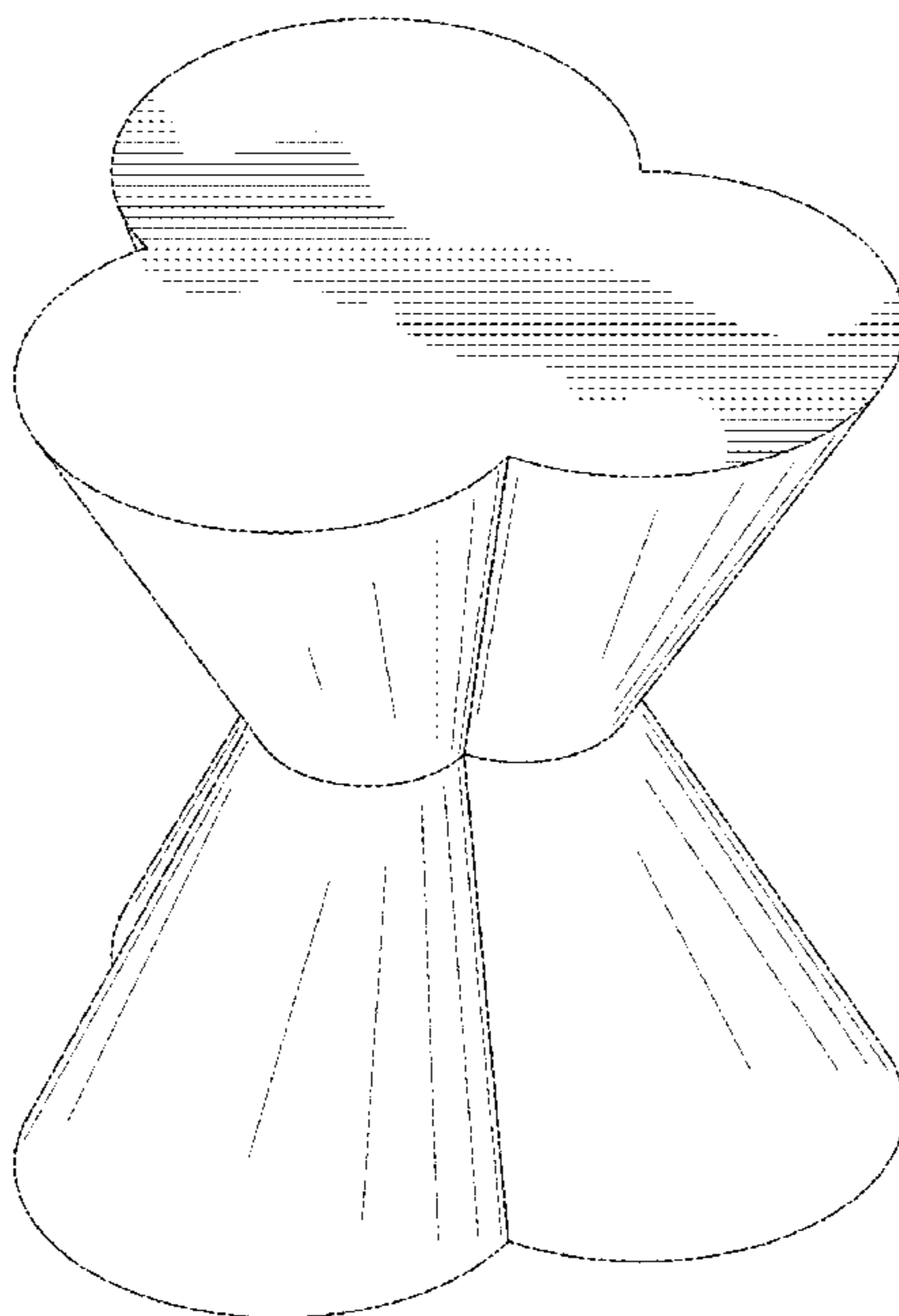

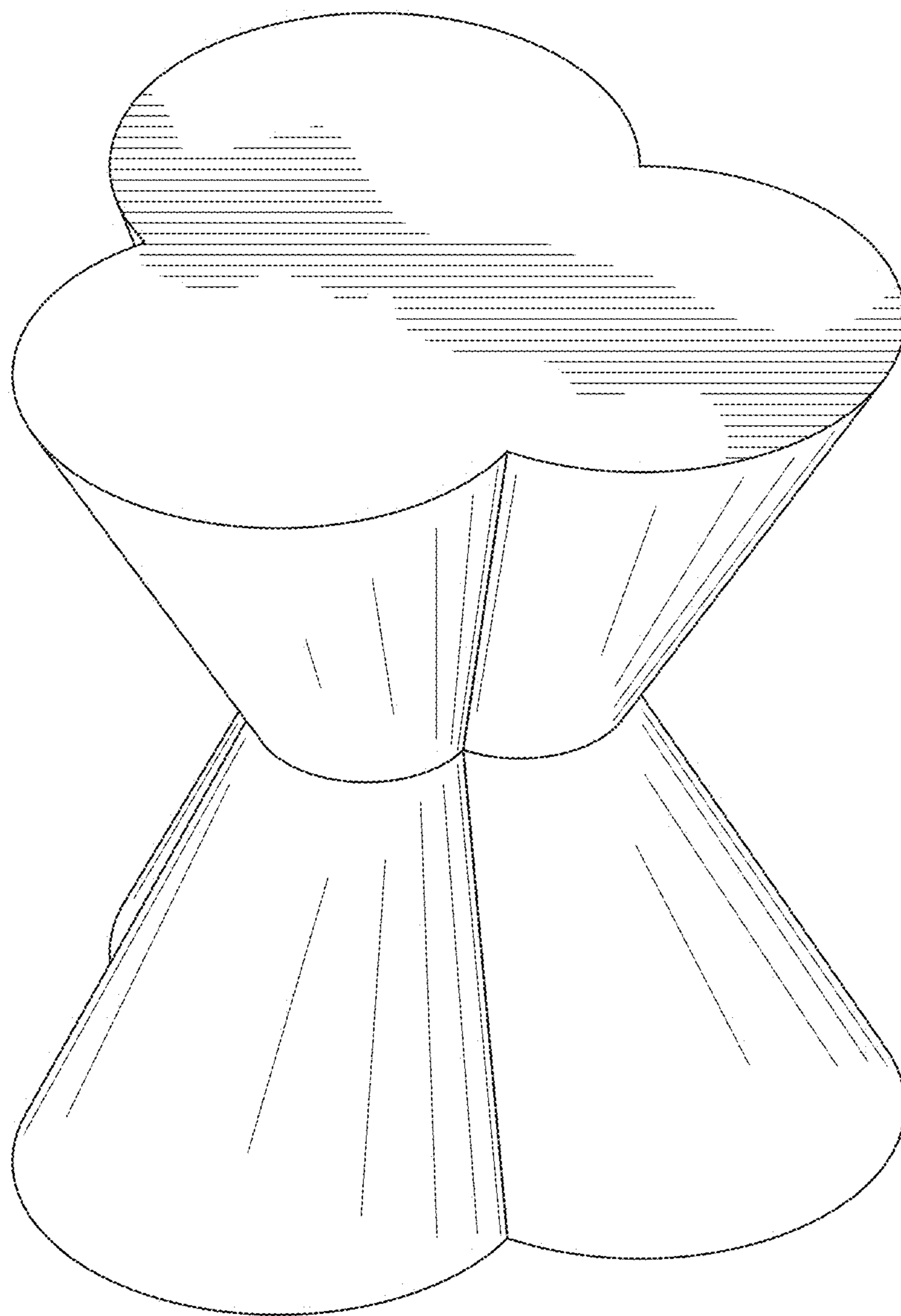

FIG. 1

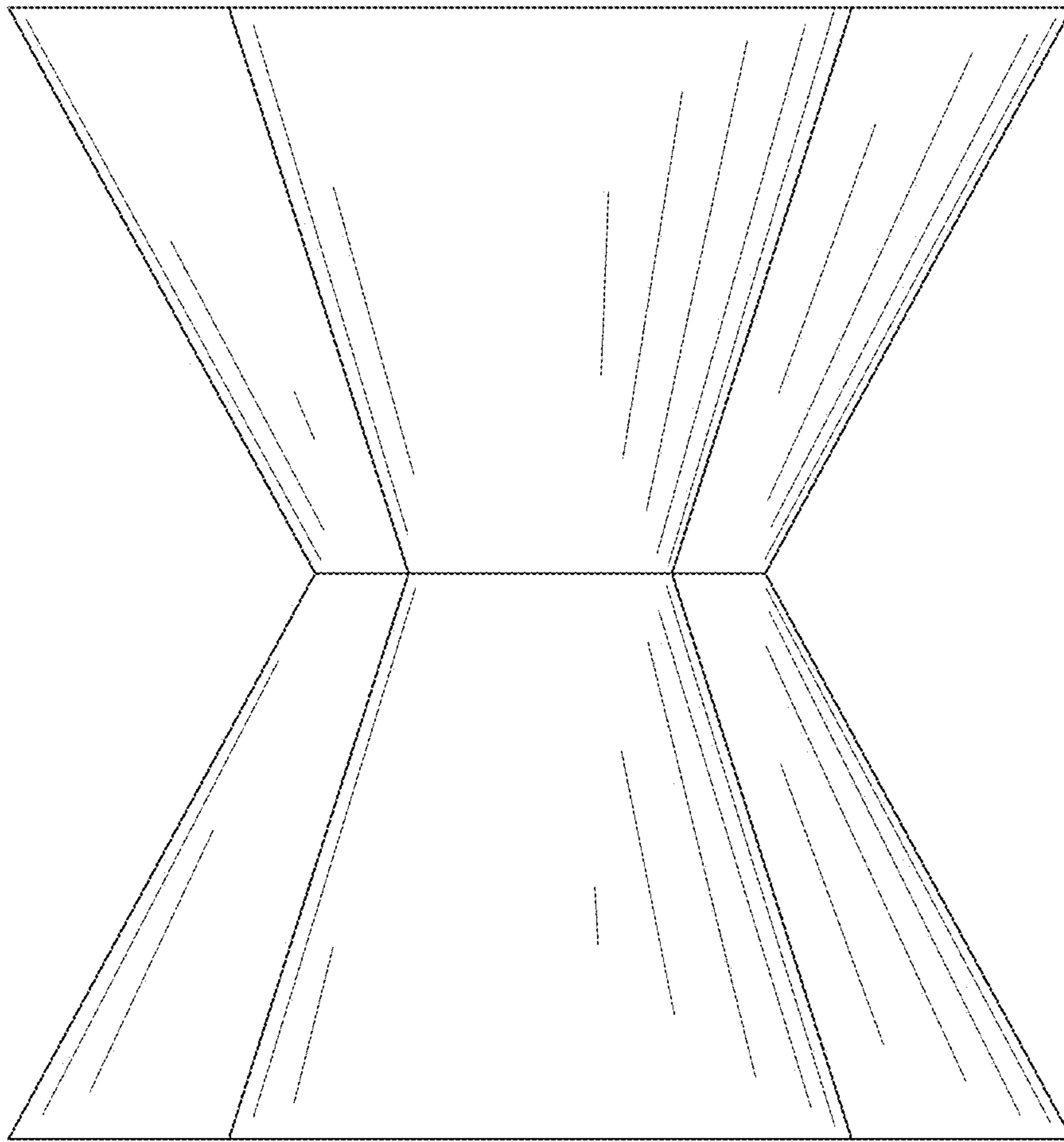
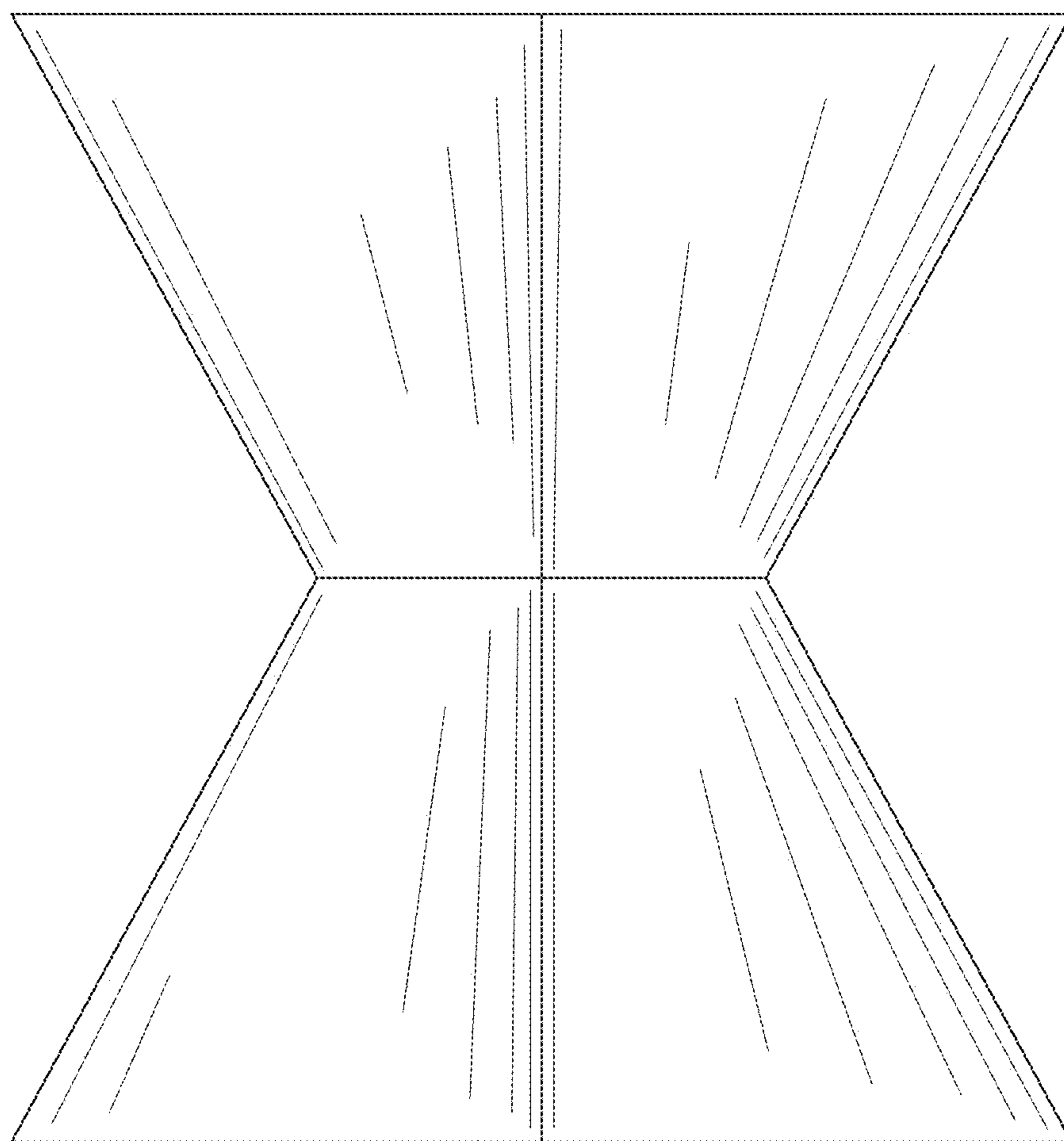

FIG. 2



**FIG. 3**

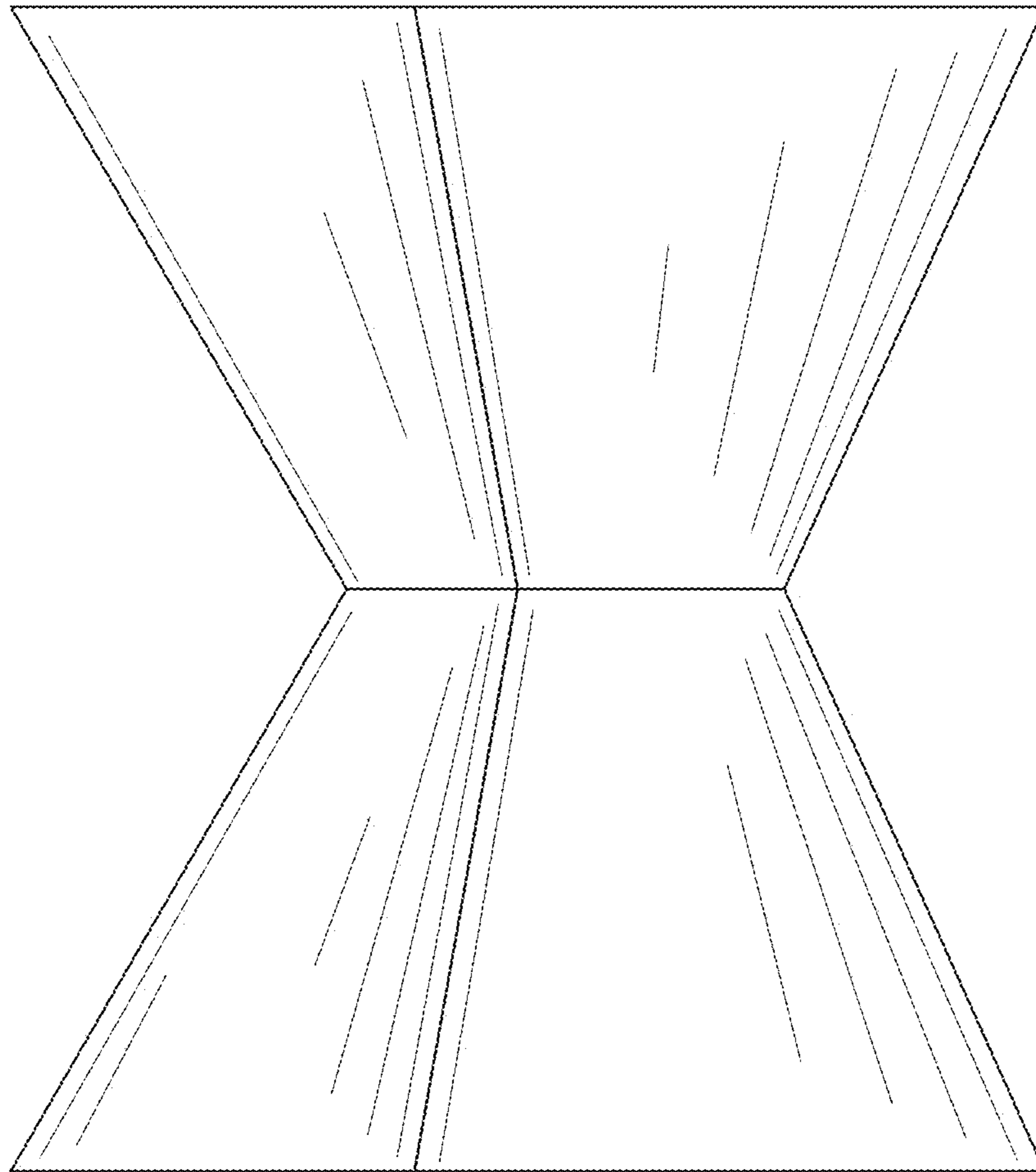

FIG. 4

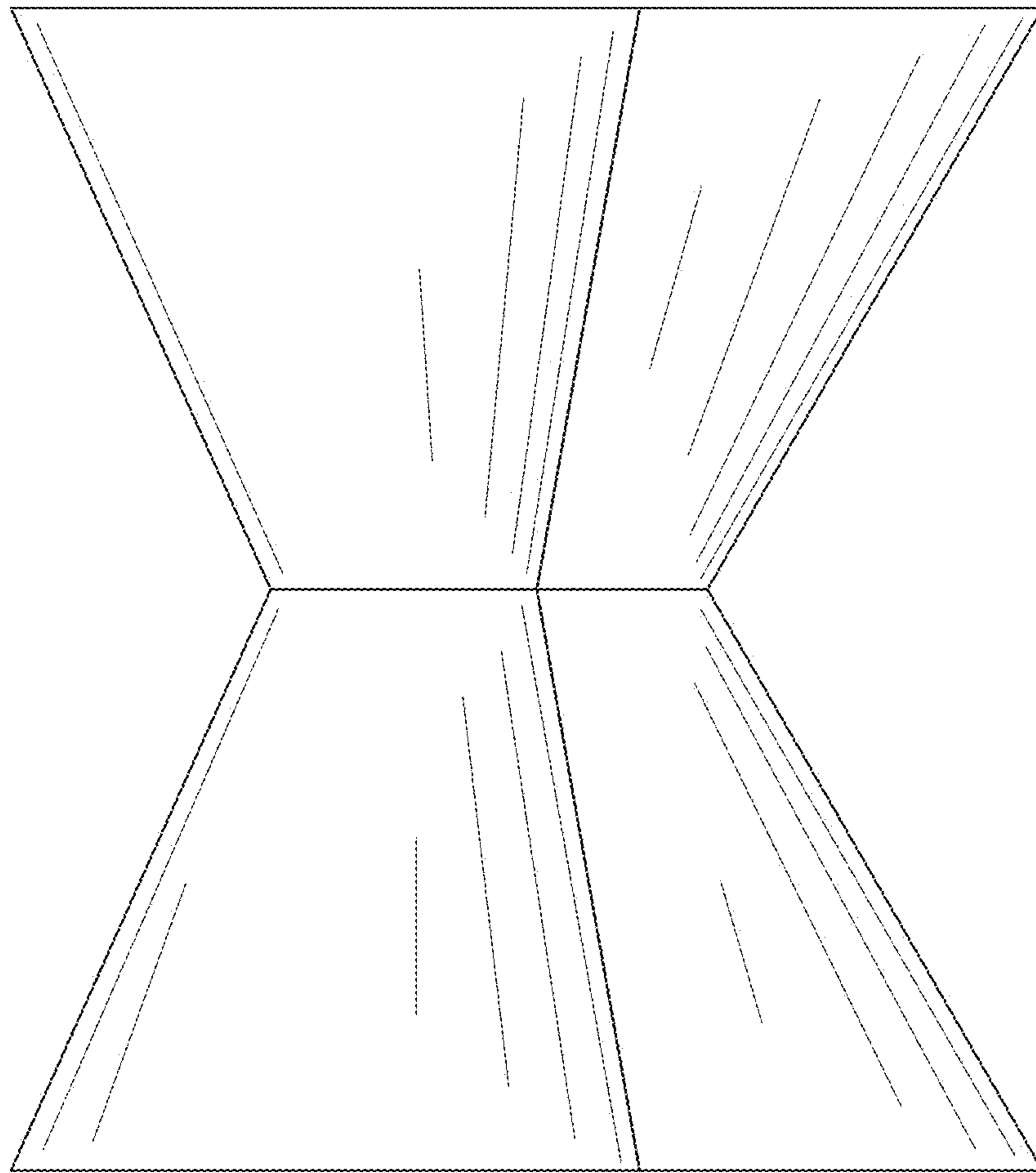

FIG. 5

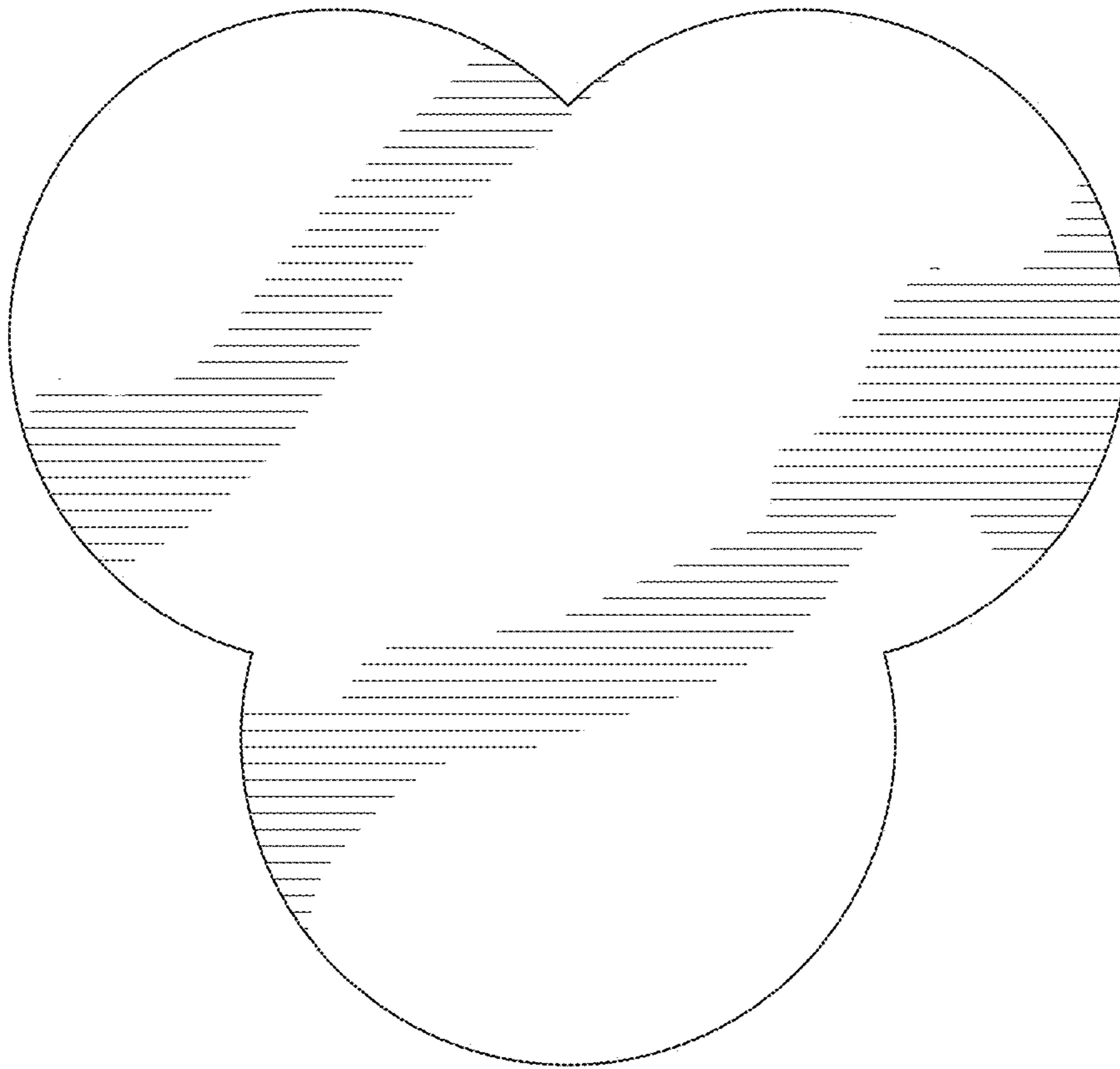

FIG. 6

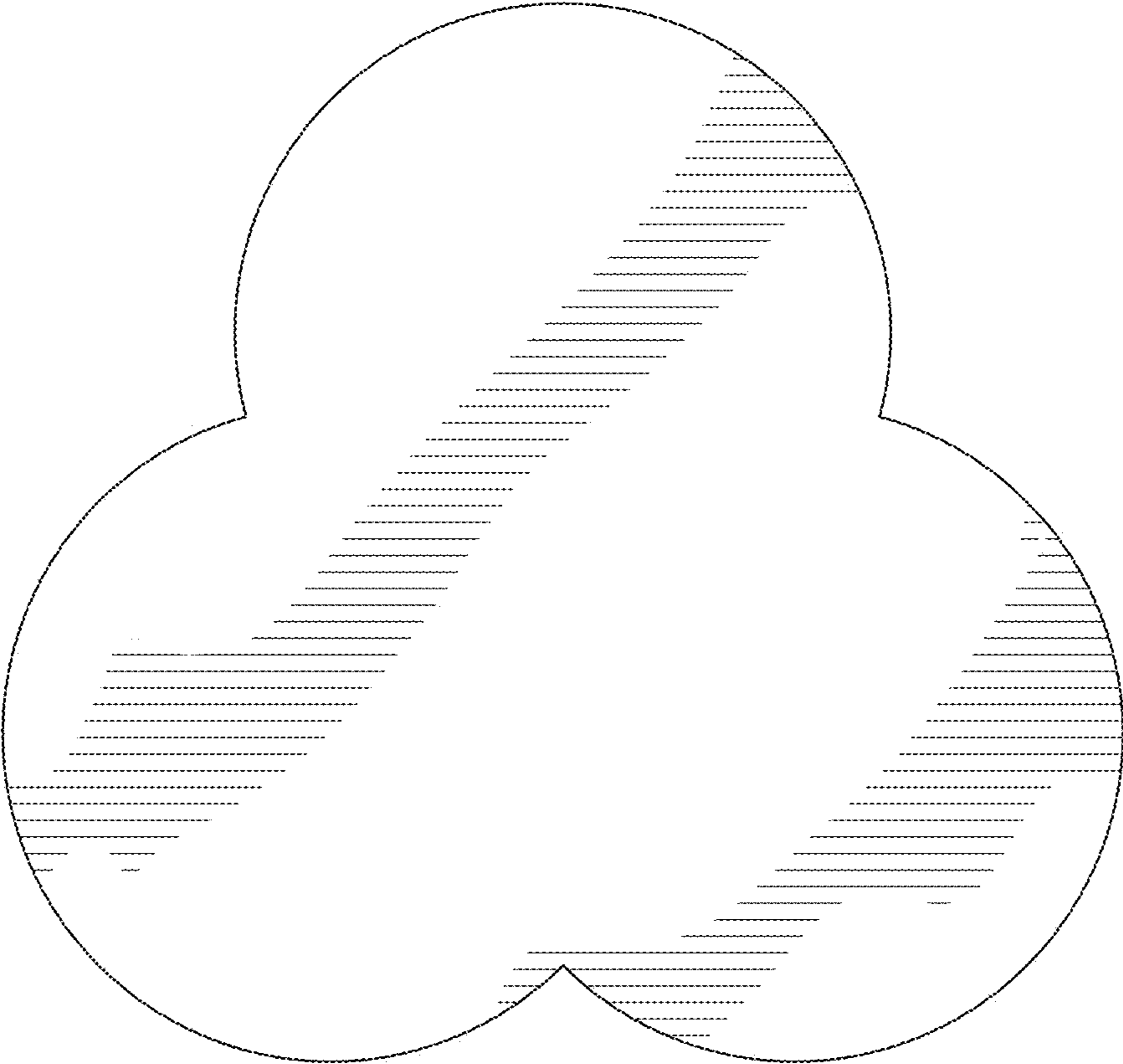

FIG. 7



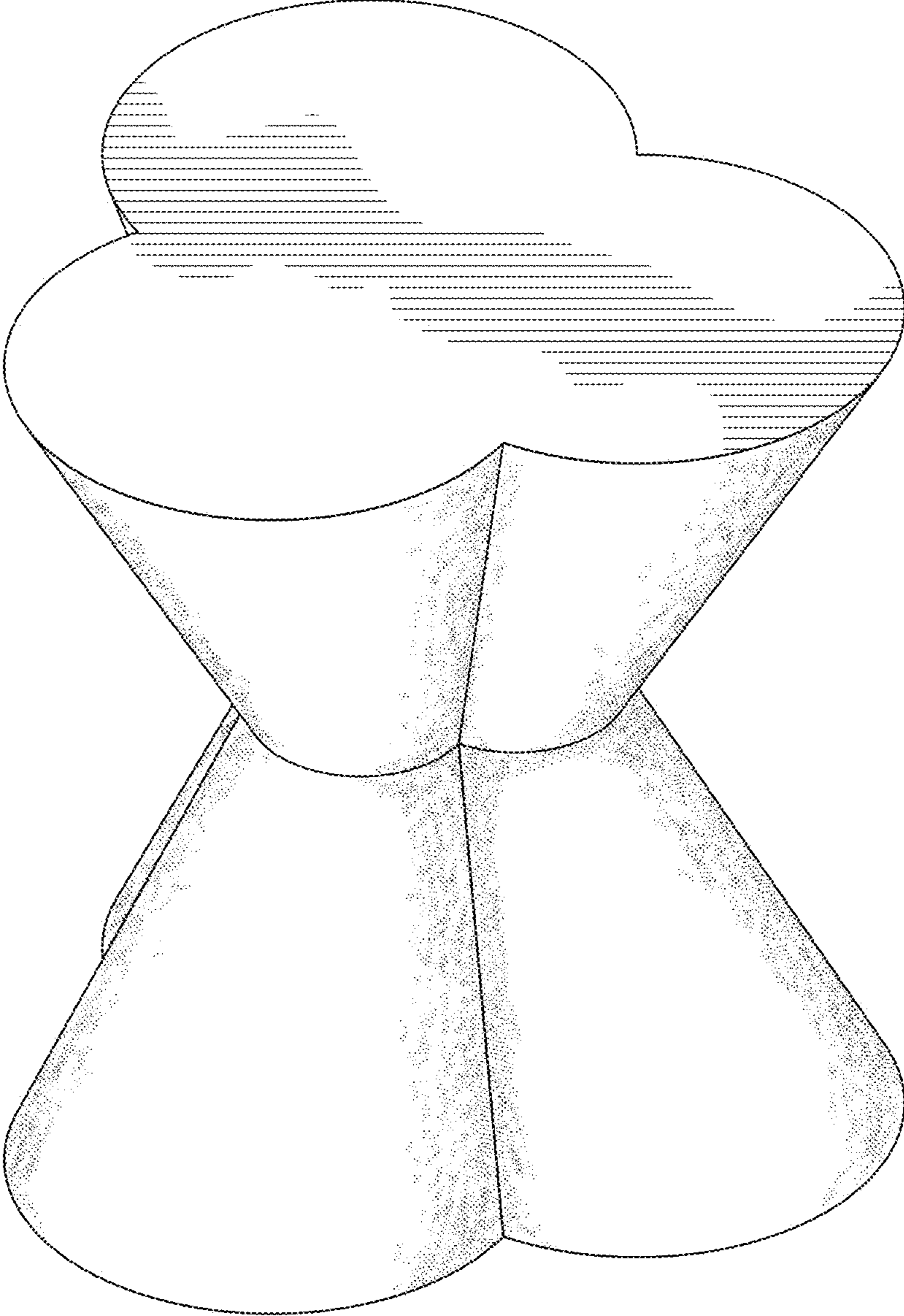

FIG. 8

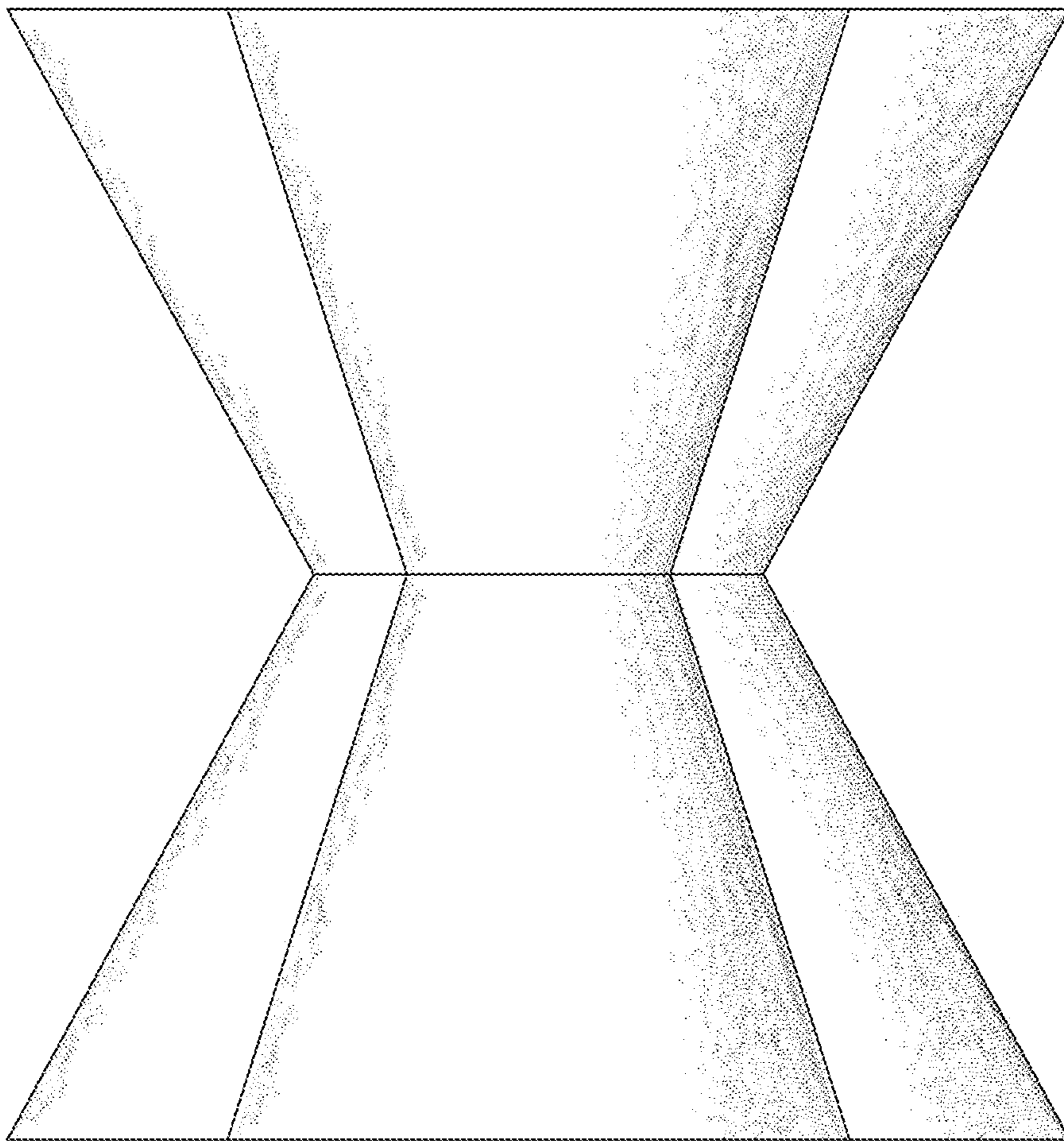
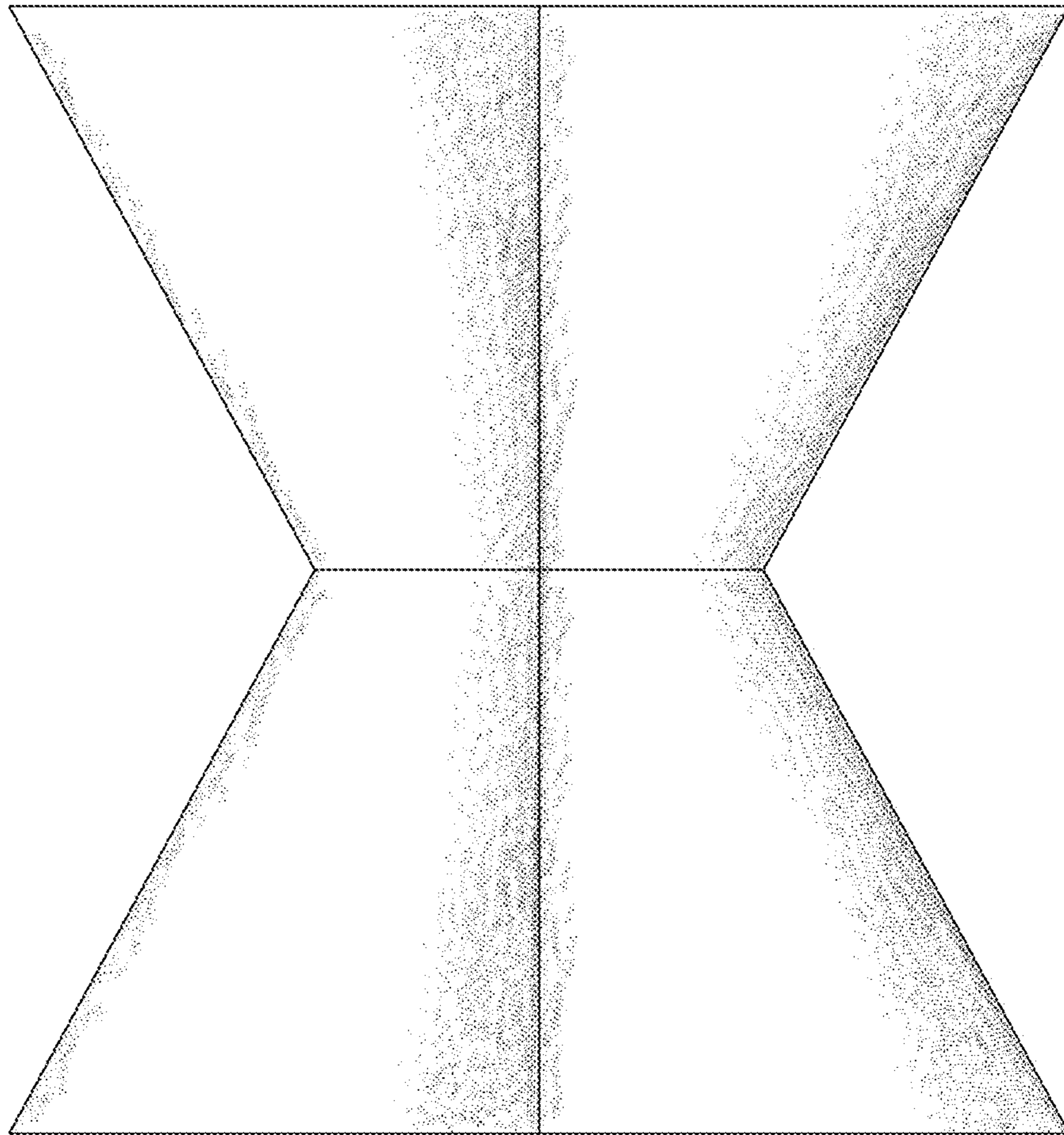
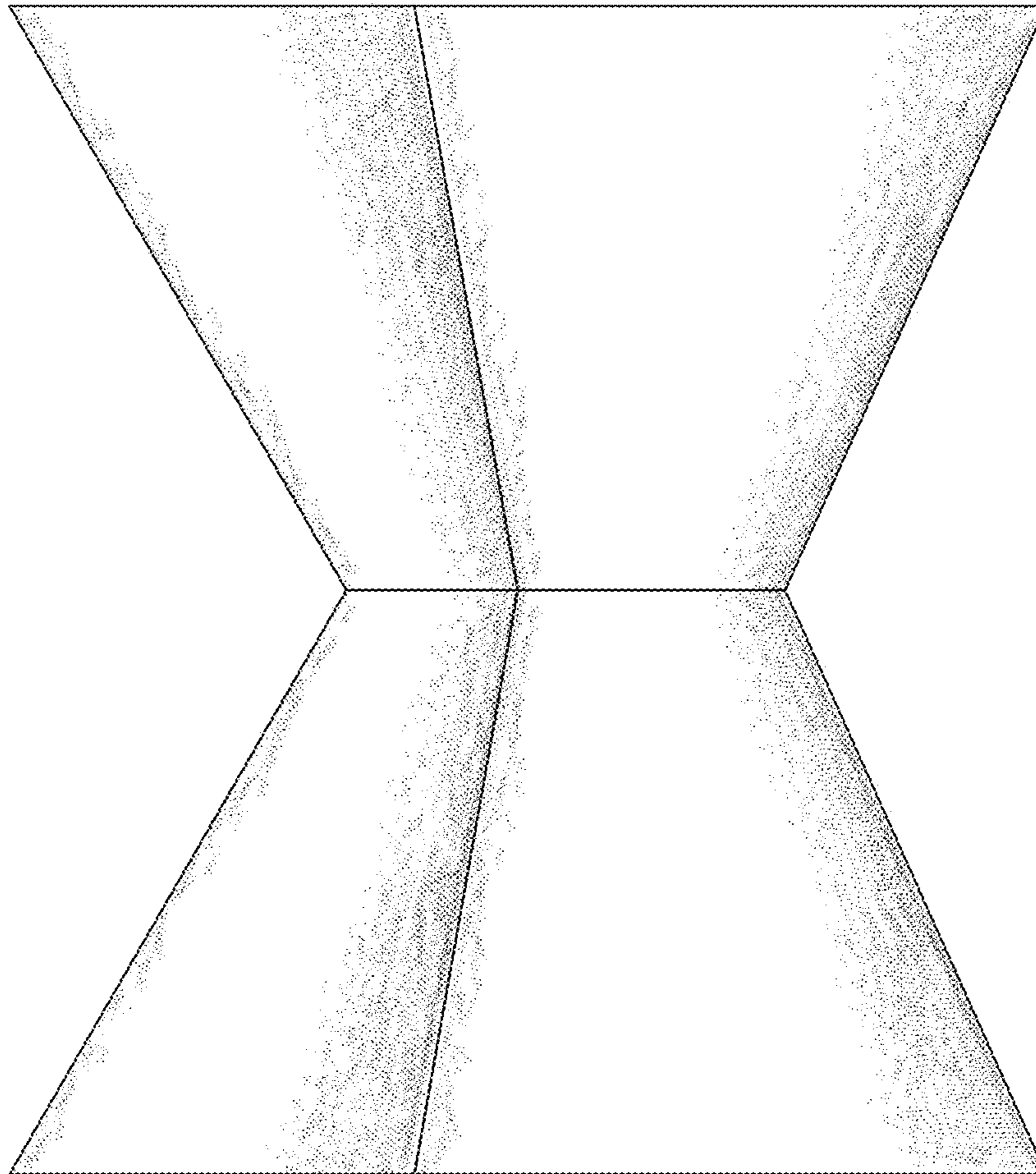

FIG. 9



**FIG. 10**



*FIG. 11*

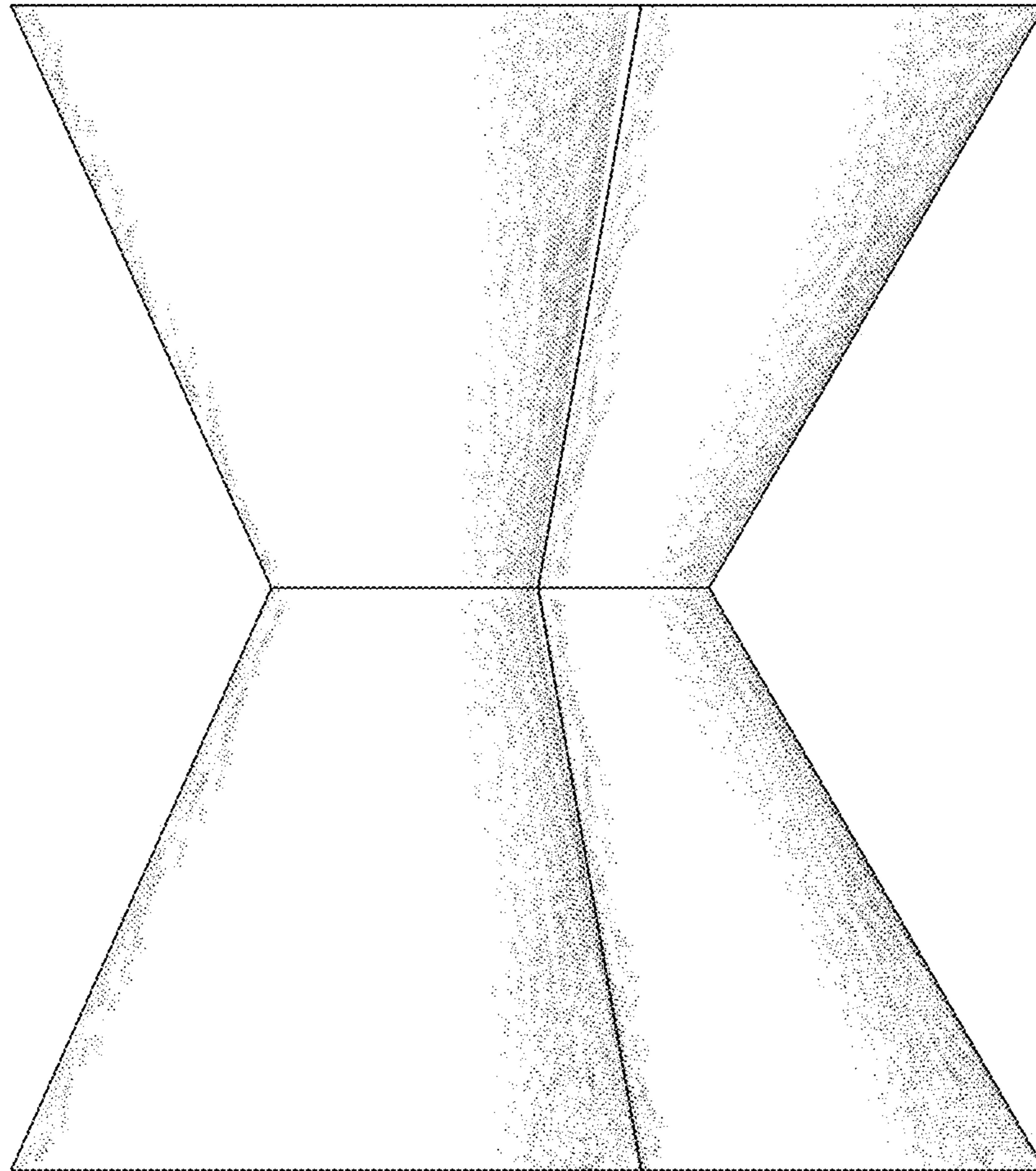
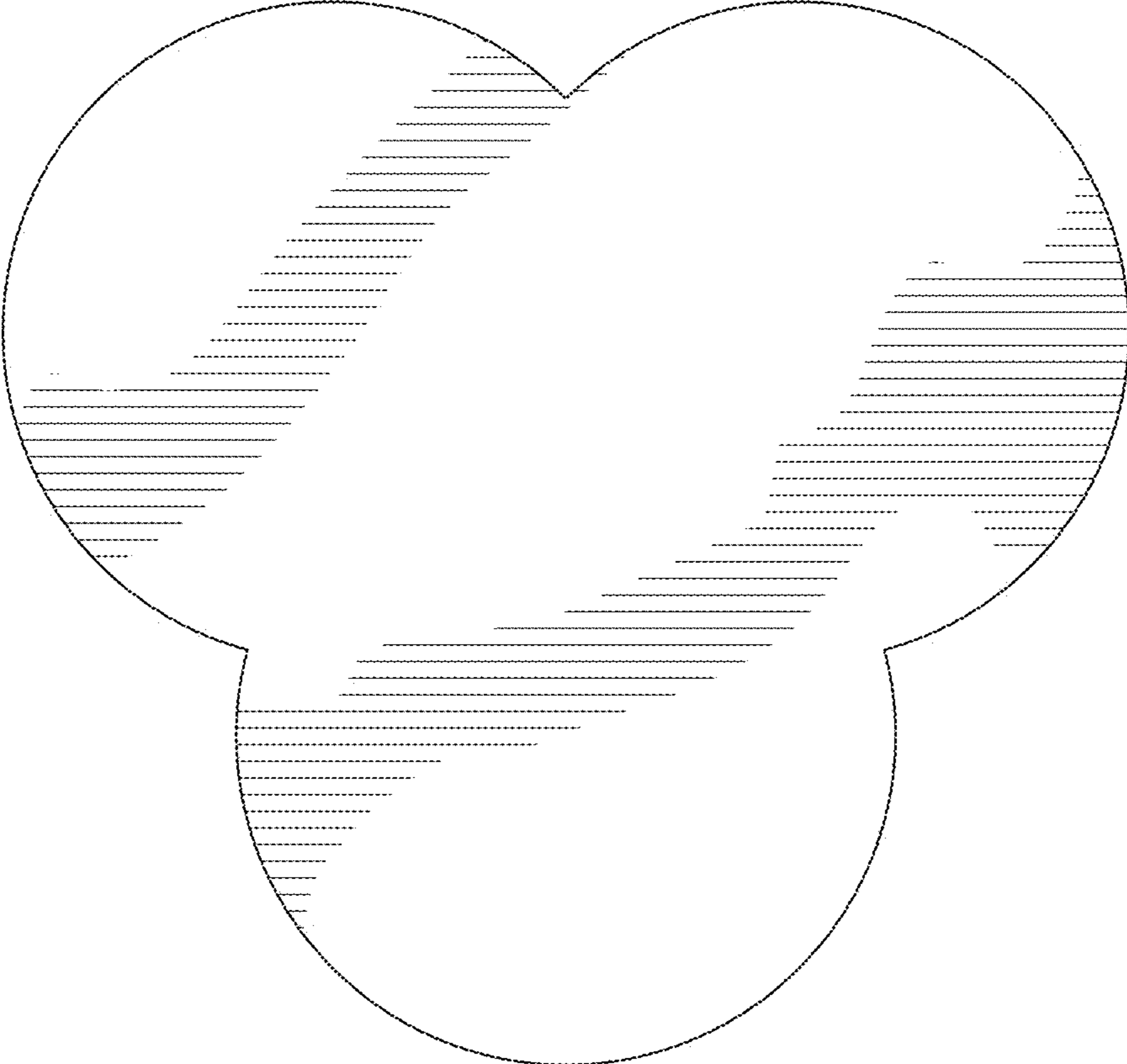

FIG. 12



**FIG. 13**

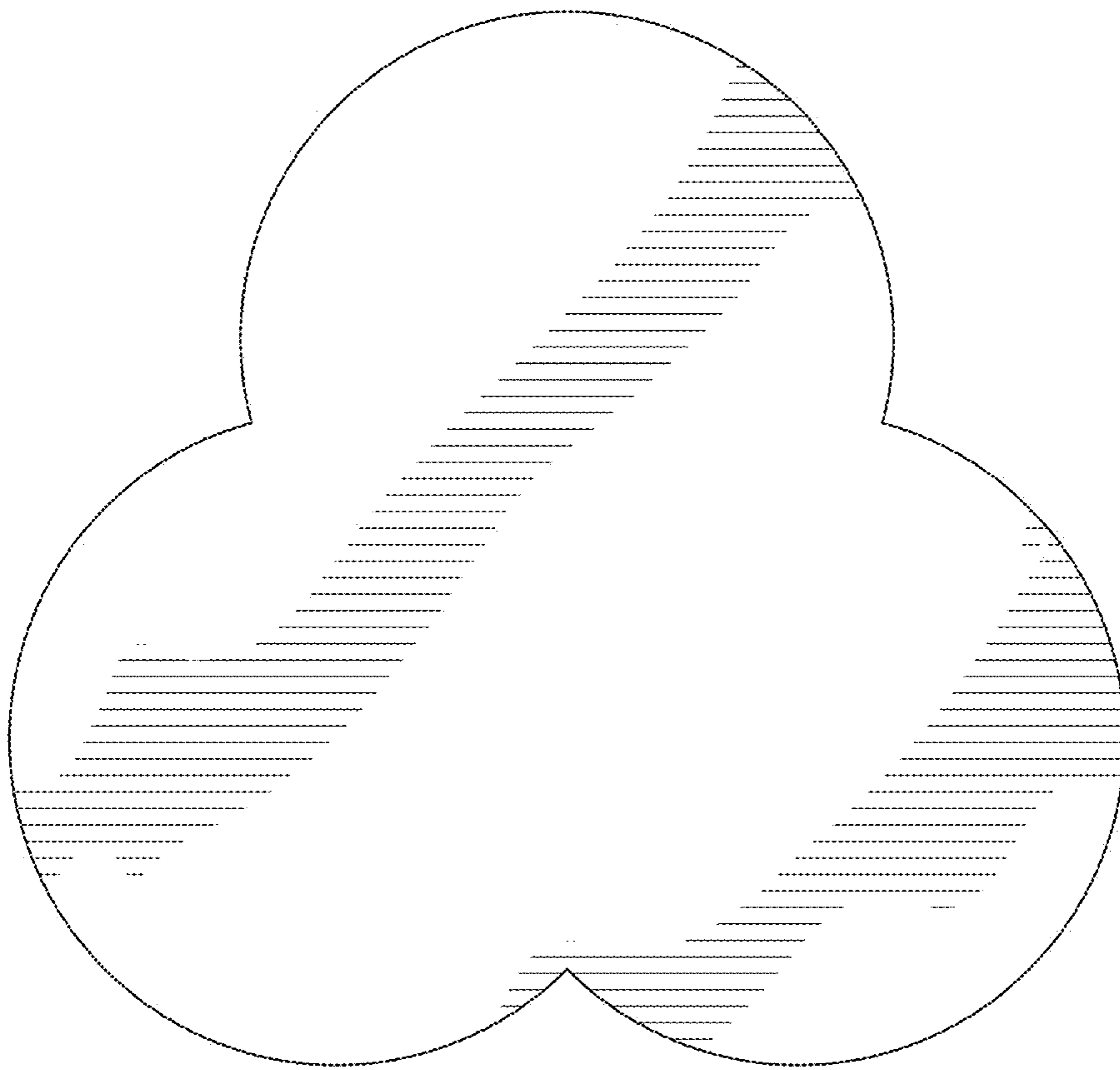

FIG. 14