



US00D749882S

(12) **United States Design Patent**  
**Garcia**

(10) **Patent No.:** **US D749,882 S**  
(45) **Date of Patent:** **\*\* Feb. 23, 2016**

- (54) **TABLE**
- (71) Applicant: **Baker, Knapp & Tubbs, Inc.**, Hickory, NC (US)
- (72) Inventor: **Jacques Garcia**, Paris (FR)
- (73) Assignee: **KOHLER INTERIORS FURNITURE COMPANY**, Hickory, NC (US)
- (\*\*) Term: **14 Years**
- (21) Appl. No.: **29/468,454**
- (22) Filed: **Sep. 30, 2013**
- (51) **LOC (10) Cl.** ..... **06-03**
- (52) **U.S. Cl.**  
USPC ..... **D6/692.6**
- (58) **Field of Classification Search**  
USPC ..... D6/692, 692.1, 692.6, 691.8; 108/150, 108/153.1, 155, 156, 157.1, 161  
See application file for complete search history.

(56) **References Cited**

U.S. PATENT DOCUMENTS

D260,836 S *	9/1981	de Polo et al.	.....	D6/484
D583,168 S *	12/2008	Lade	.....	D6/484
D612,177 S *	3/2010	Marietta	.....	D6/511

*Primary Examiner* — Janice Seeger

(74) *Attorney, Agent, or Firm* — Foley & Lardner LLP

(57) **CLAIM**

I claim the ornamental design for a table, as shown and described.

**DESCRIPTION**

FIG. 1 is a top perspective view of an exemplary embodiment of the claimed design;  
 FIG. 2 is a side view of the embodiment shown in FIG. 1;  
 FIG. 3 is another side view of the embodiment shown in FIG. 1;  
 FIG. 4 is a top view of the embodiment shown in FIG. 1;  
 FIG. 5 is a bottom view of the embodiment shown in FIG. 1;  
 FIG. 6 is another side view of the embodiment shown in FIG. 1;  
 FIG. 7 is another side view of the embodiment shown in FIG. 1;

FIG. 8 is a top perspective view of an exemplary embodiment of the claimed design;  
 FIG. 9 is a side view of the embodiment shown in FIG. 8;  
 FIG. 10 is another side view of the embodiment shown in FIG. 8;  
 FIG. 11 is a top view of the embodiment shown in FIG. 8;  
 FIG. 12 is a bottom view of the embodiment shown in FIG. 8;  
 FIG. 13 is another side view of the embodiment shown in FIG. 8;  
 FIG. 14 is another side view of the embodiment shown in FIG. 8;  
 FIG. 15 is a top perspective view of an exemplary embodiment of the claimed design;  
 FIG. 16 is a side view of the embodiment shown in FIG. 15;  
 FIG. 17 is another side view of the embodiment shown in FIG. 15;  
 FIG. 18 is a top view of the embodiment shown in FIG. 15;  
 FIG. 19 is a bottom view of the embodiment shown in FIG. 15;  
 FIG. 20 is another side view of the embodiment shown in FIG. 15;  
 FIG. 21 is another side view of the embodiment shown in FIG. 15;  
 FIG. 22 is a top perspective view of an exemplary embodiment of the claimed design;  
 FIG. 23 is a side view of the embodiment shown in FIG. 22;  
 FIG. 24 is another side view of the embodiment shown in FIG. 22;  
 FIG. 25 is a top view of the embodiment shown in FIG. 22;  
 FIG. 26 is a bottom view of the embodiment shown in FIG. 22;  
 FIG. 27 is another side view of the embodiment shown in FIG. 22; and,  
 FIG. 28 is another side view of the embodiment shown in FIG. 22.

The broken lines in the drawings are for illustrative purposes only and form no part of the claimed design. Broken lines formed by equal length dashes show unclaimed portions of the design. Broken lines formed of unequal length dashes (i.e., dash-dot) show boundaries between claimed and unclaimed portions of the design. Portions shown in stipple shading as opposed to line shading show contrasting surfaces.

**1 Claim, 24 Drawing Sheets**

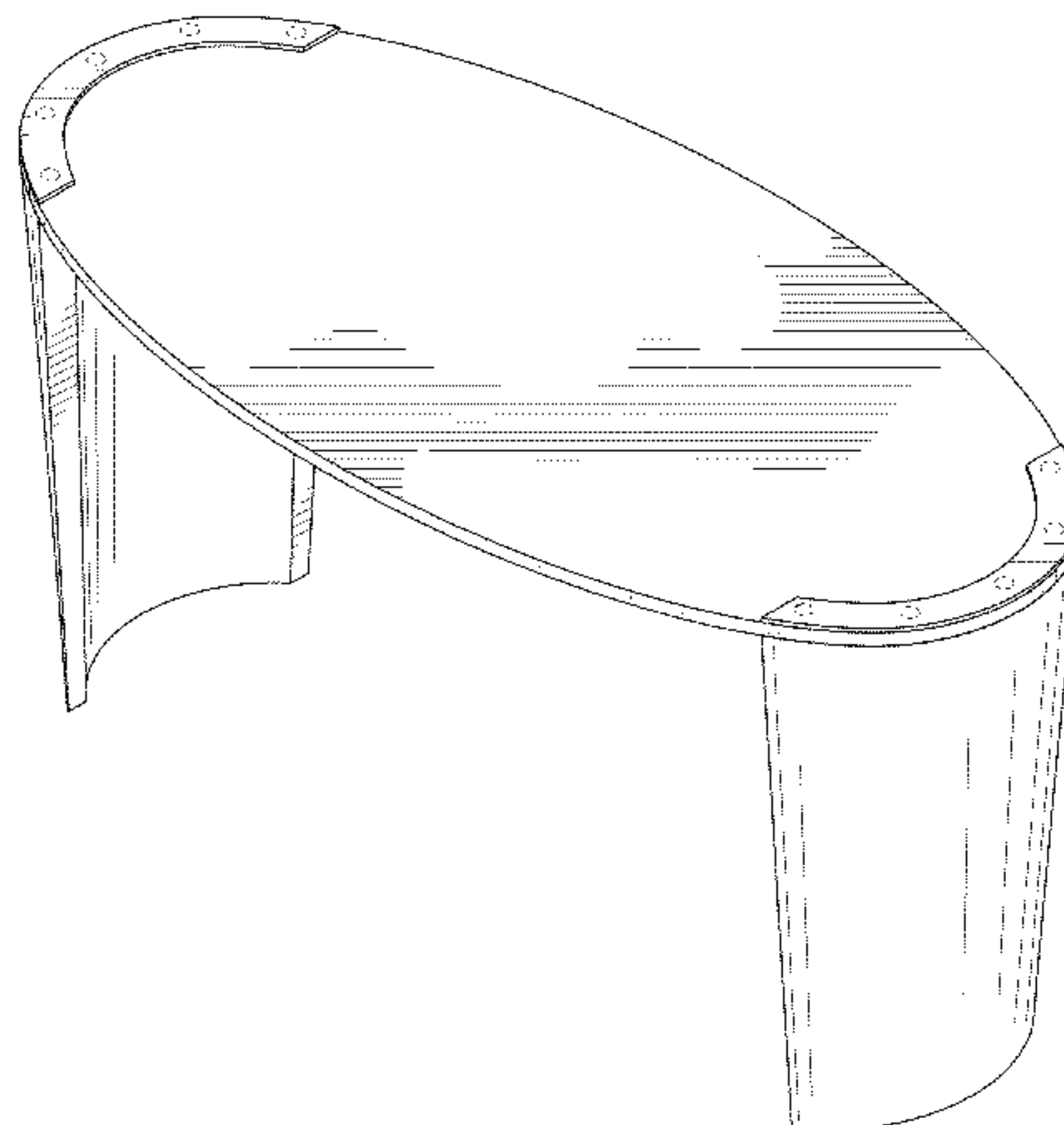

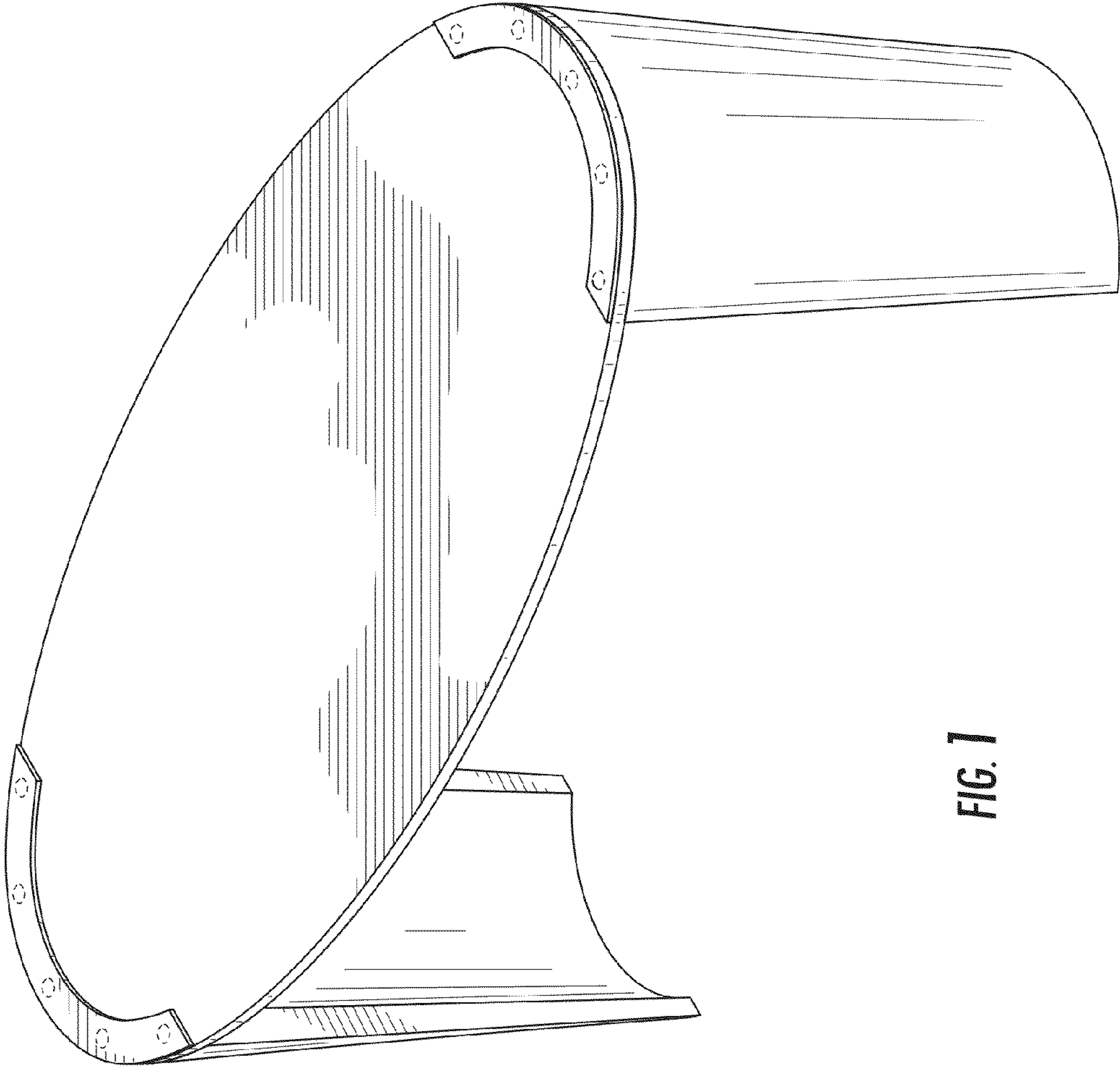

FIG. 1

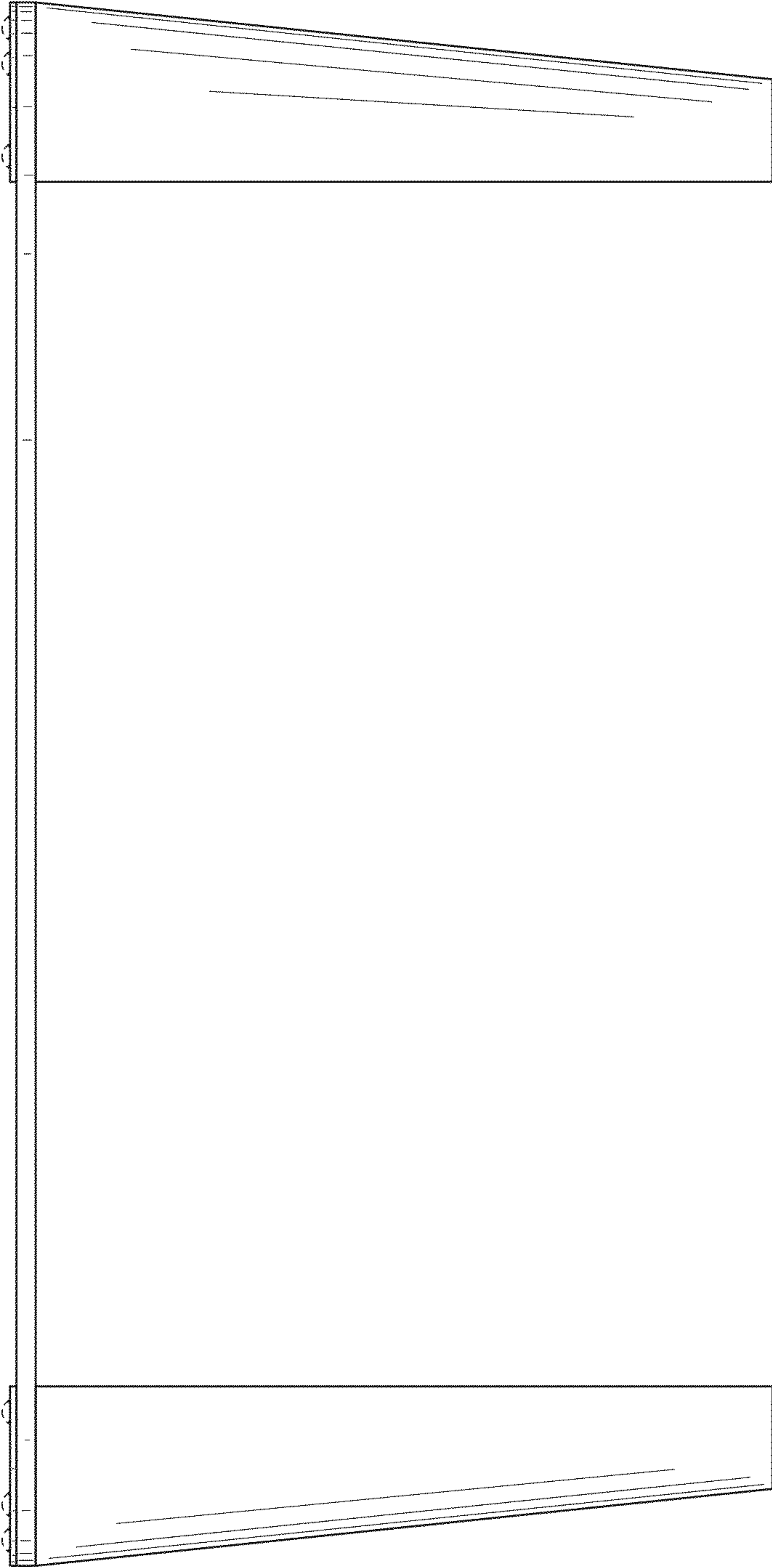

FIG. 2

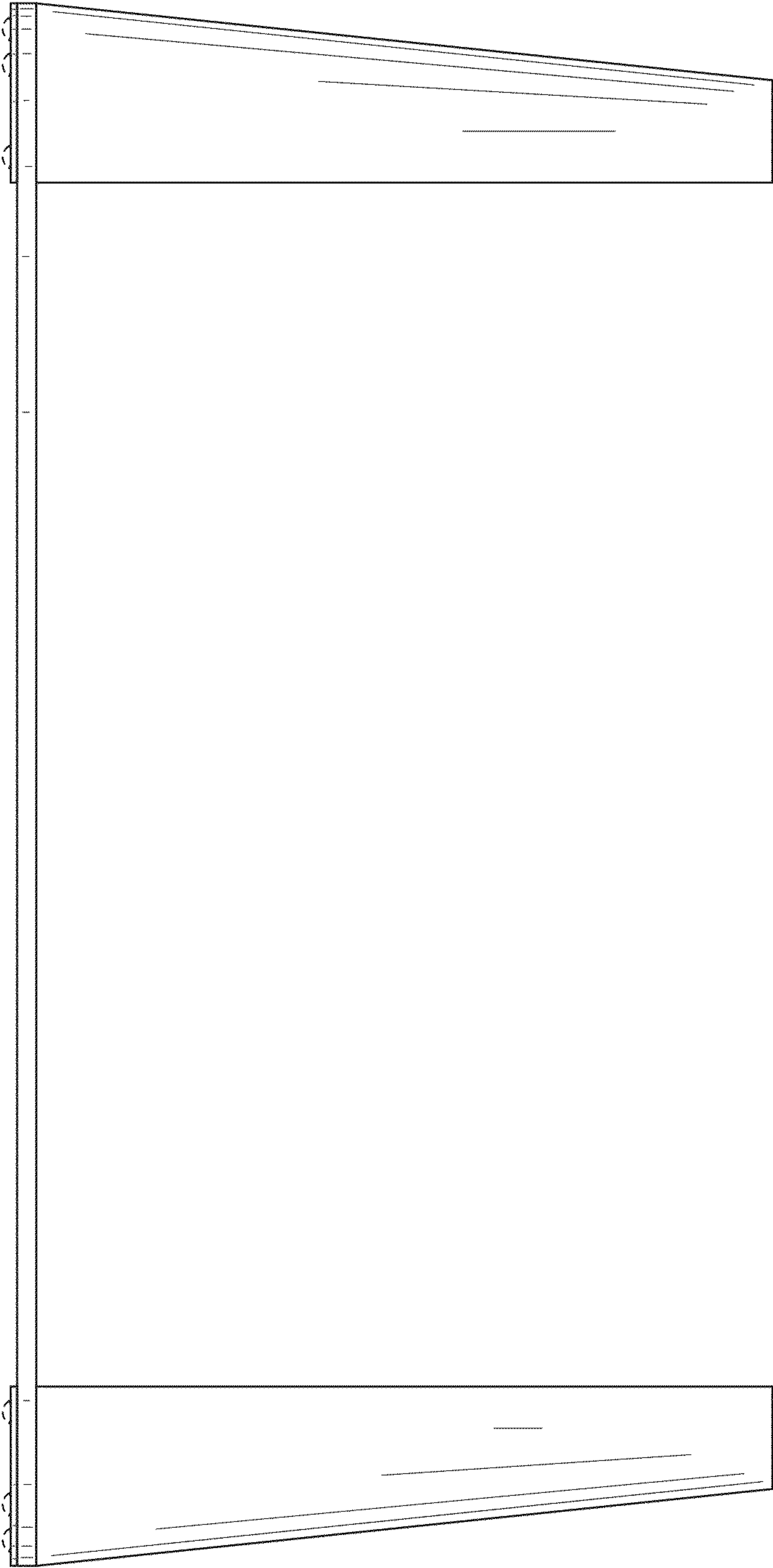

FIG. 3

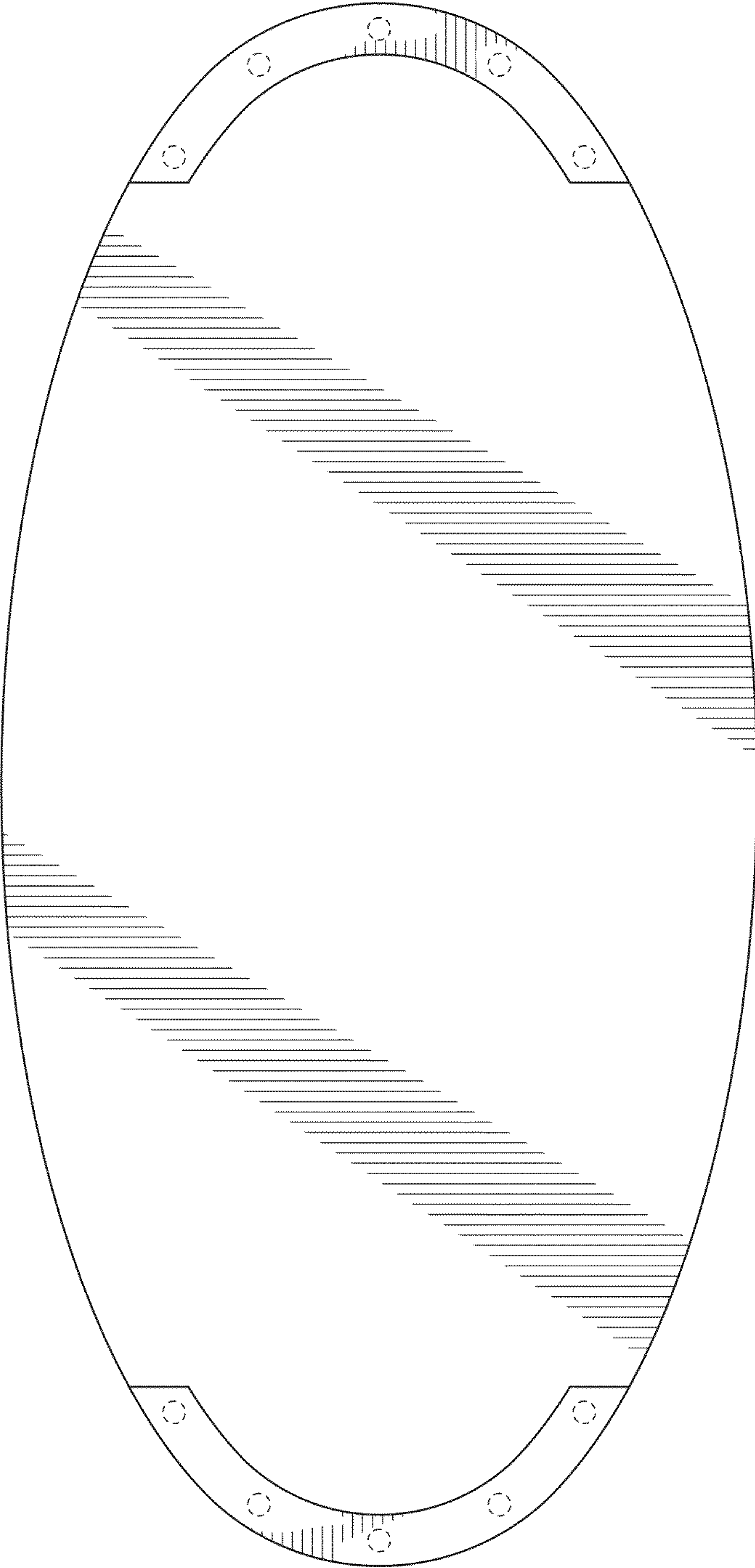

FIG. 4

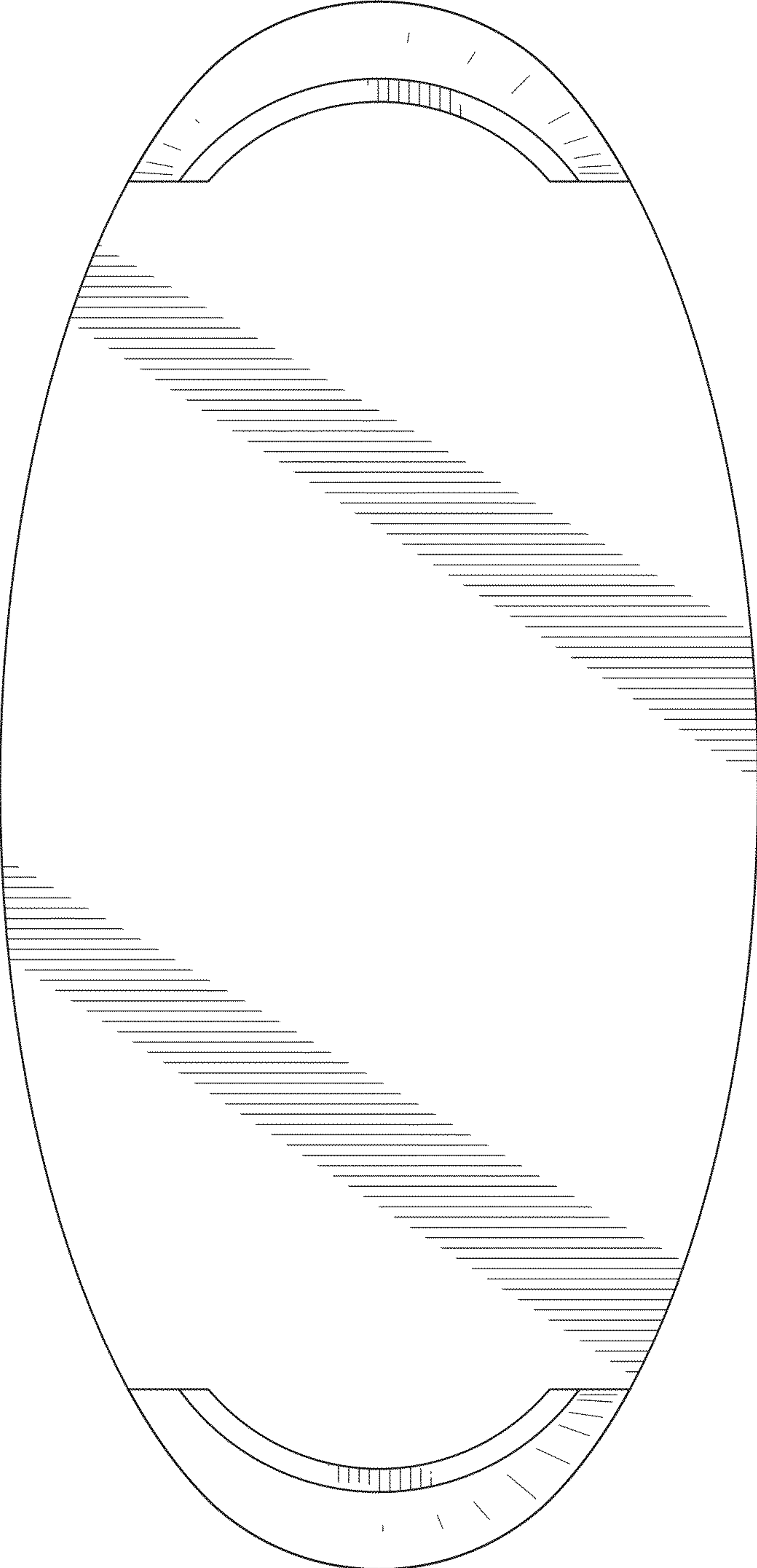
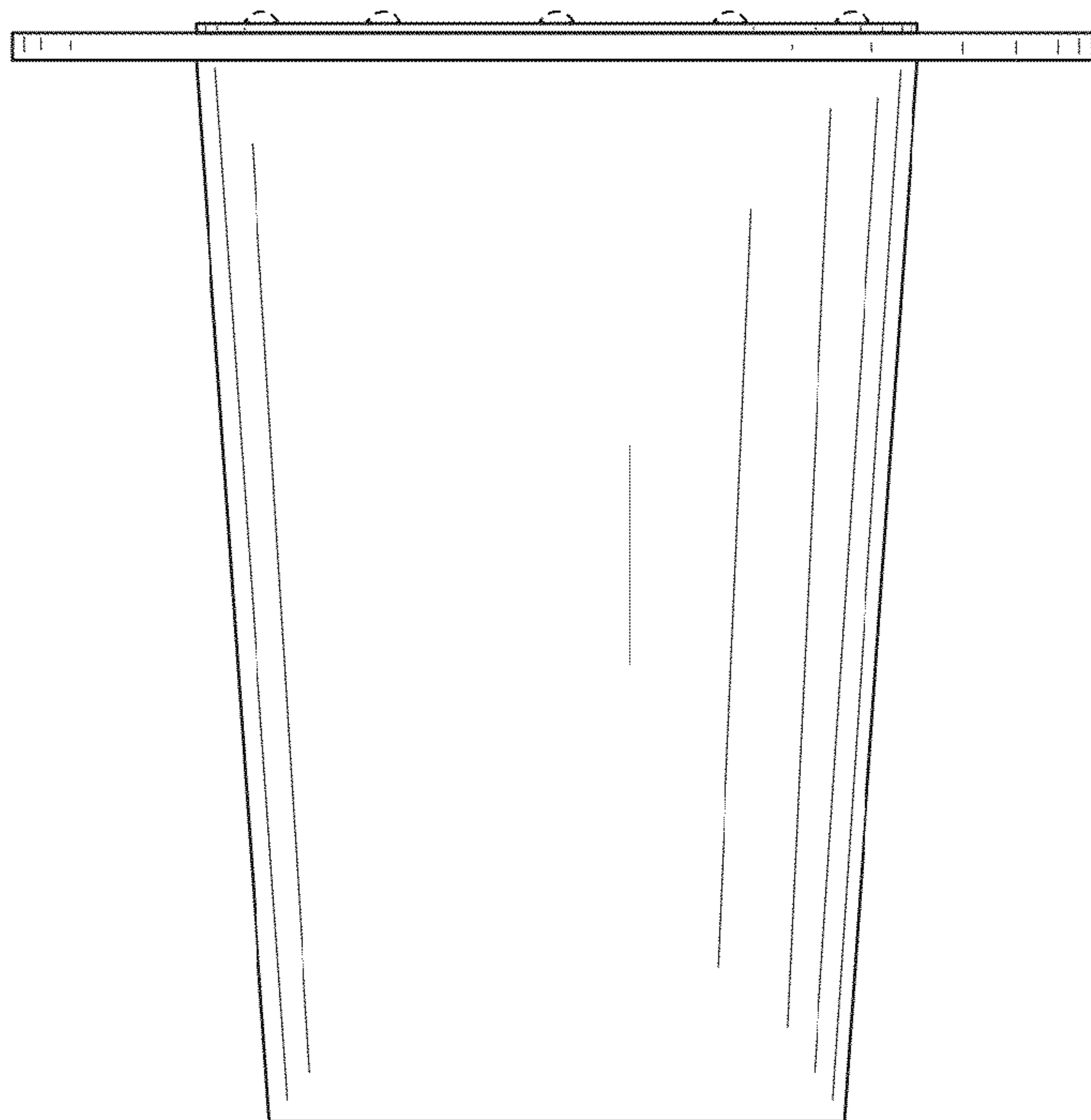
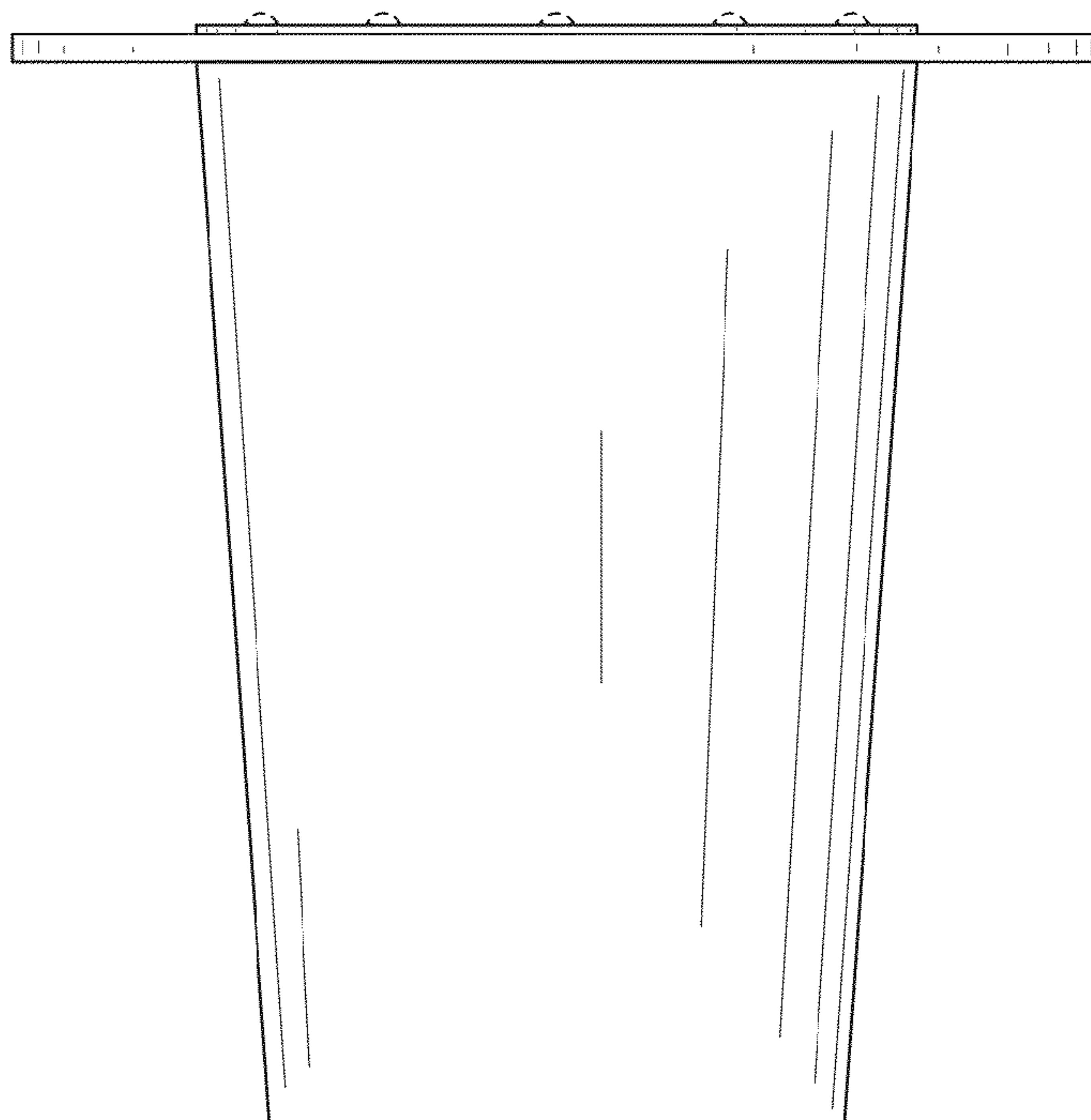

FIG. 5





**FIG. 6**



**FIG. 7**

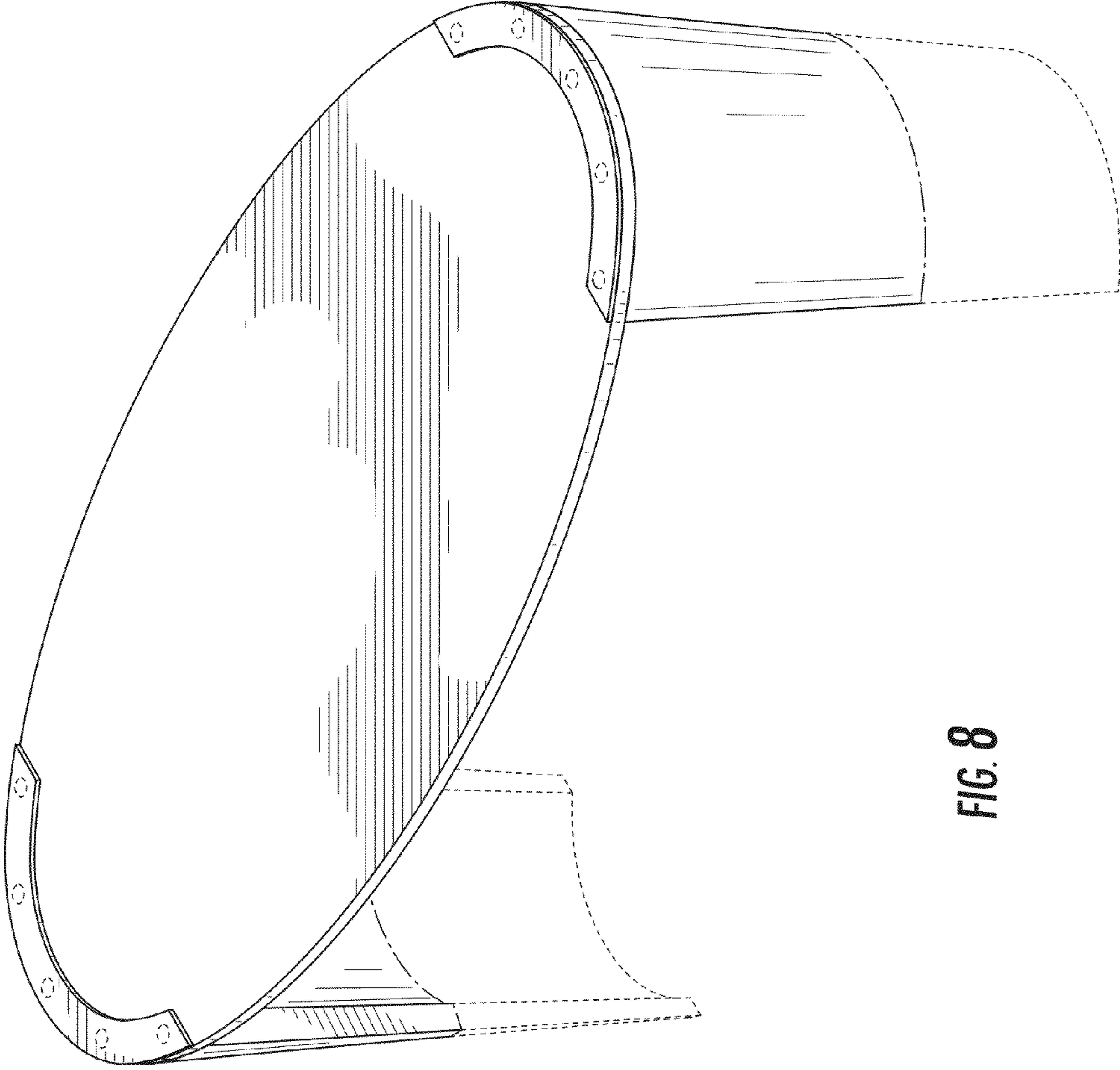

FIG. 8



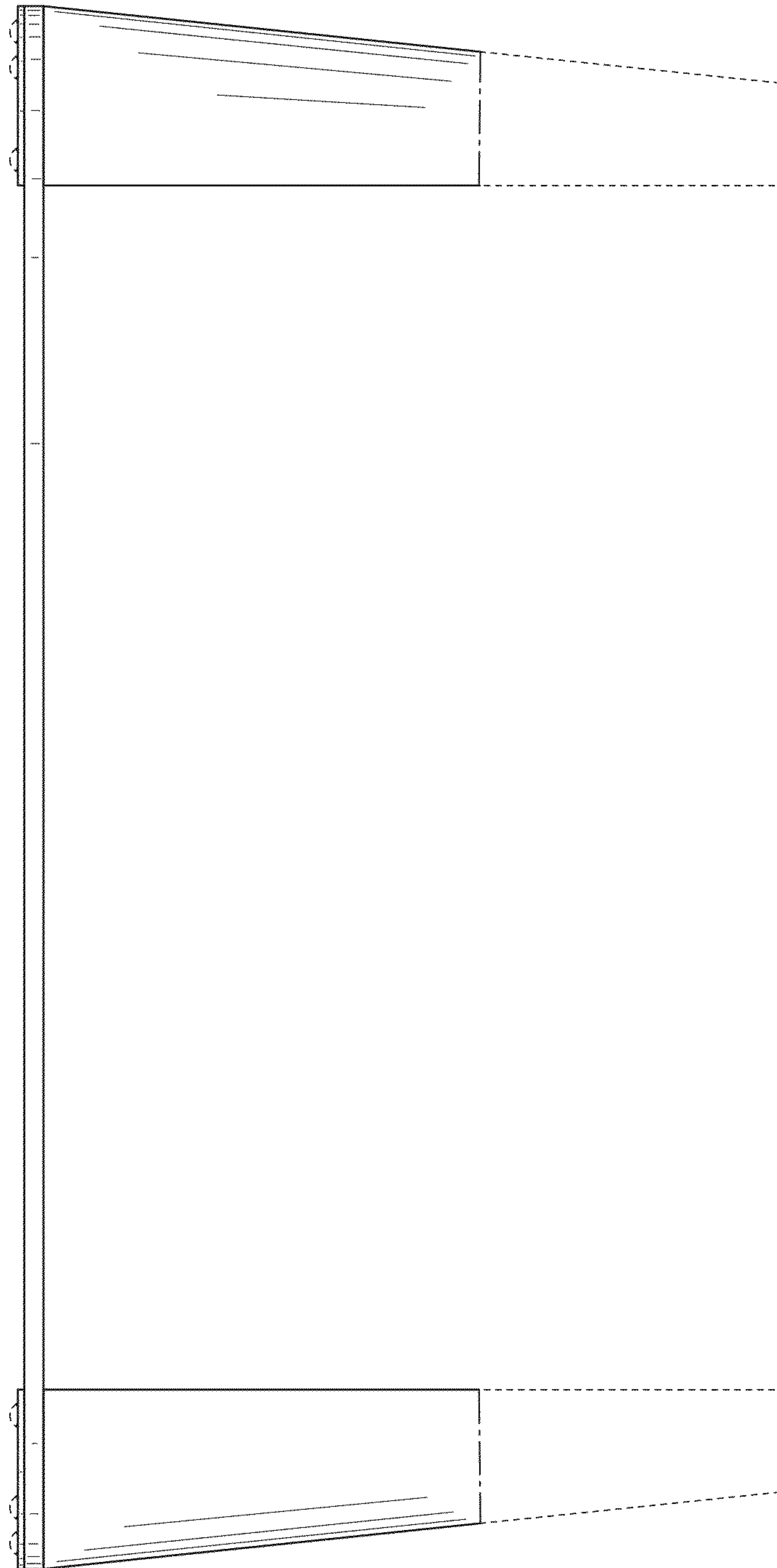

FIG. 9

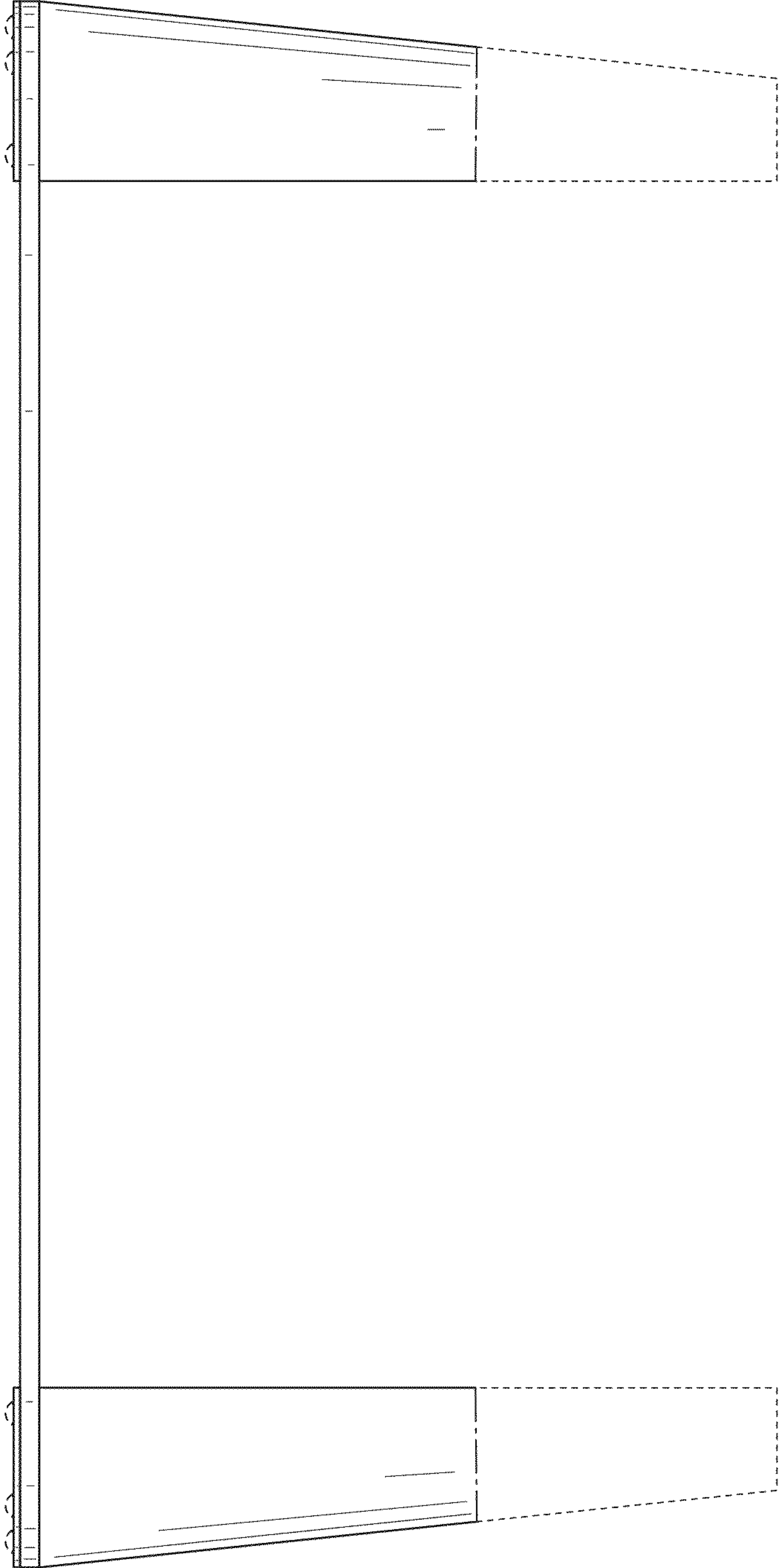

FIG. 10

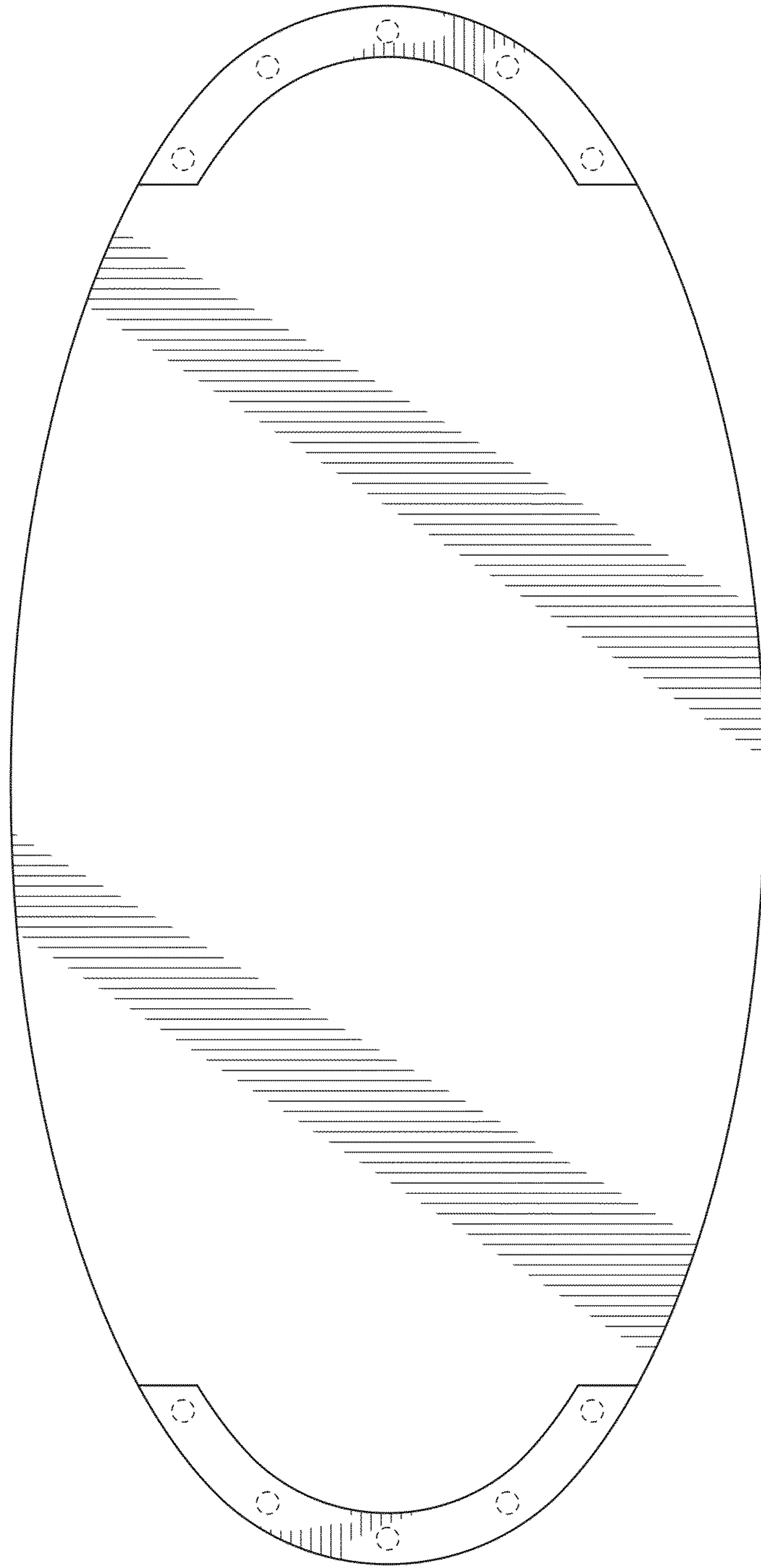

FIG. 17

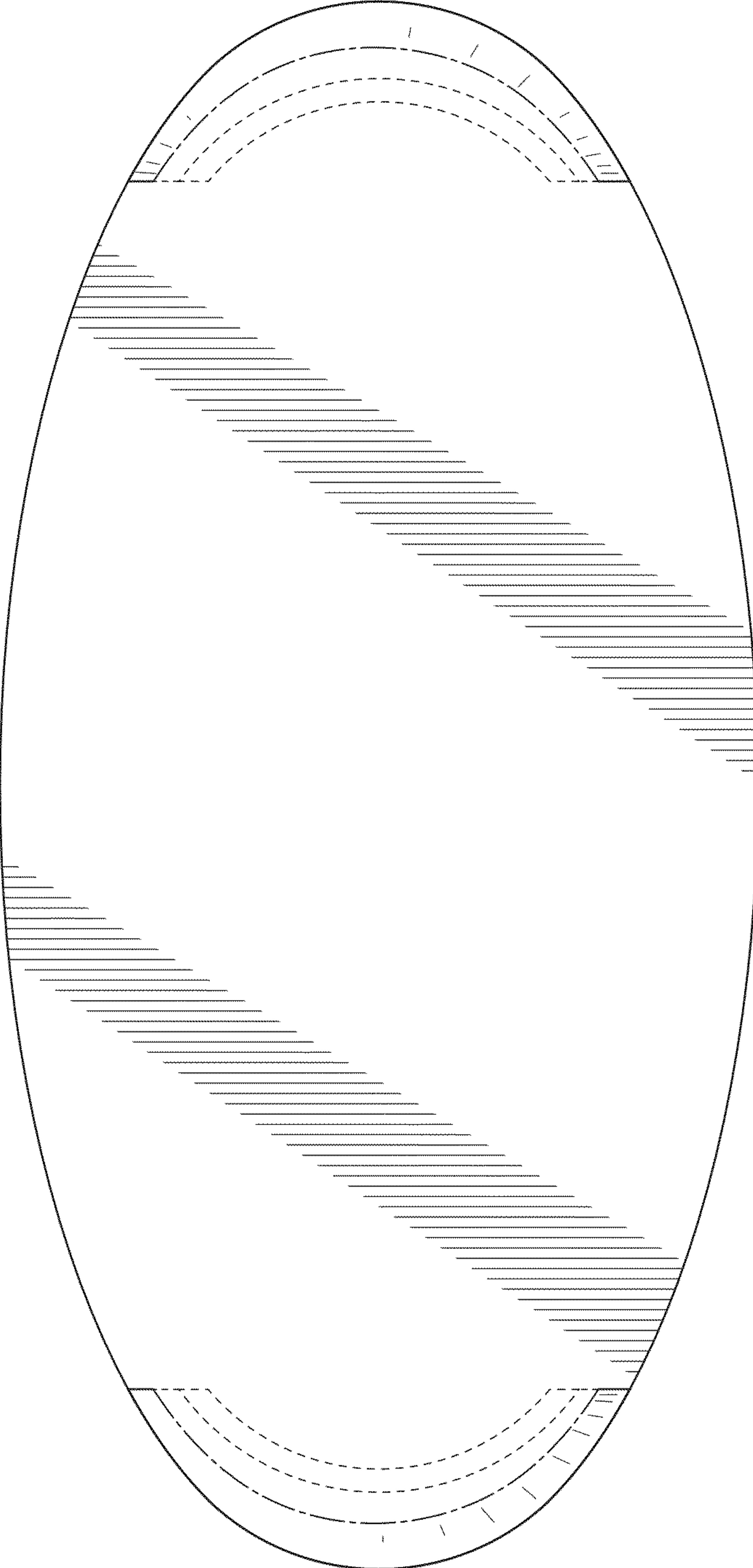
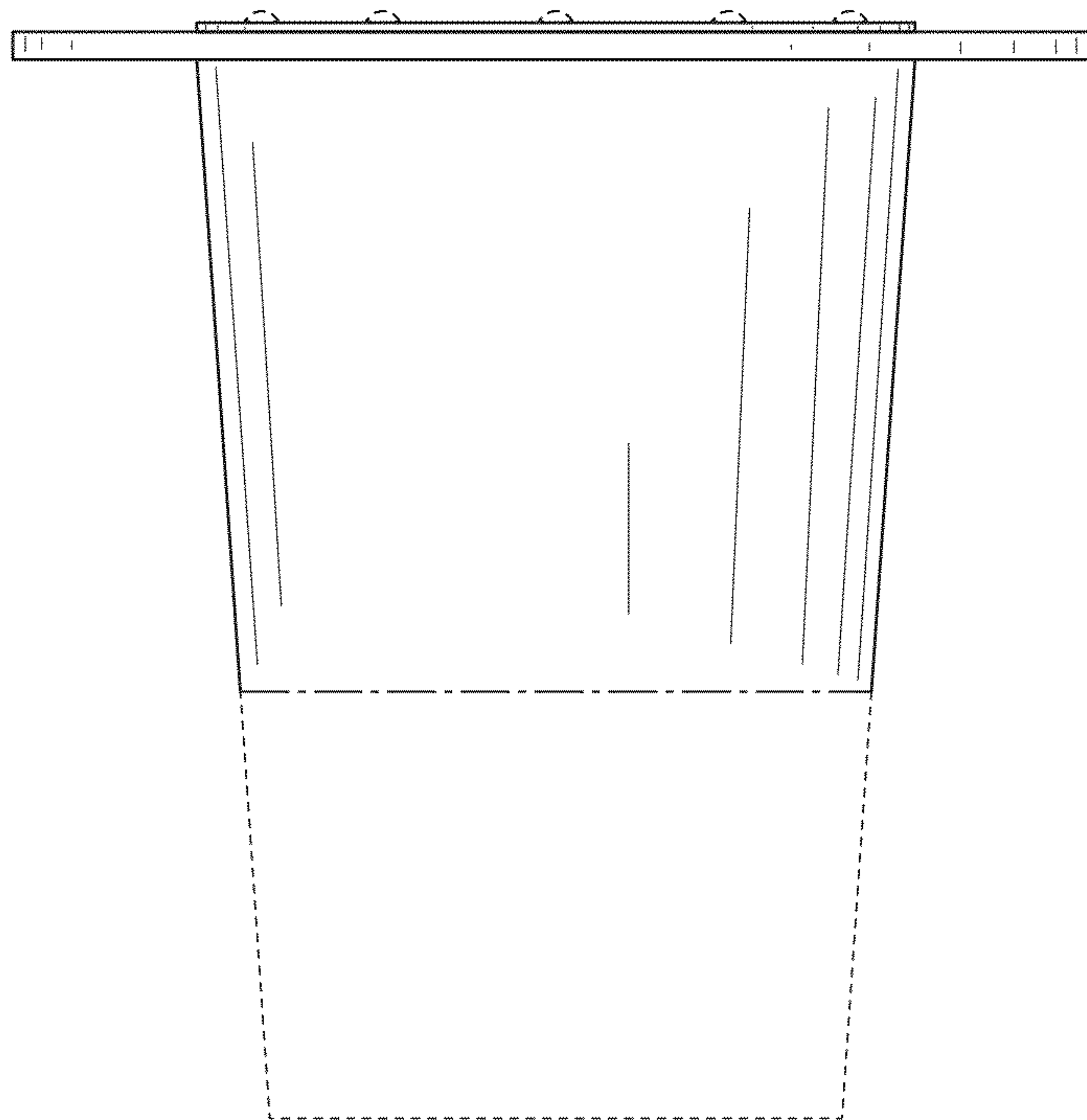
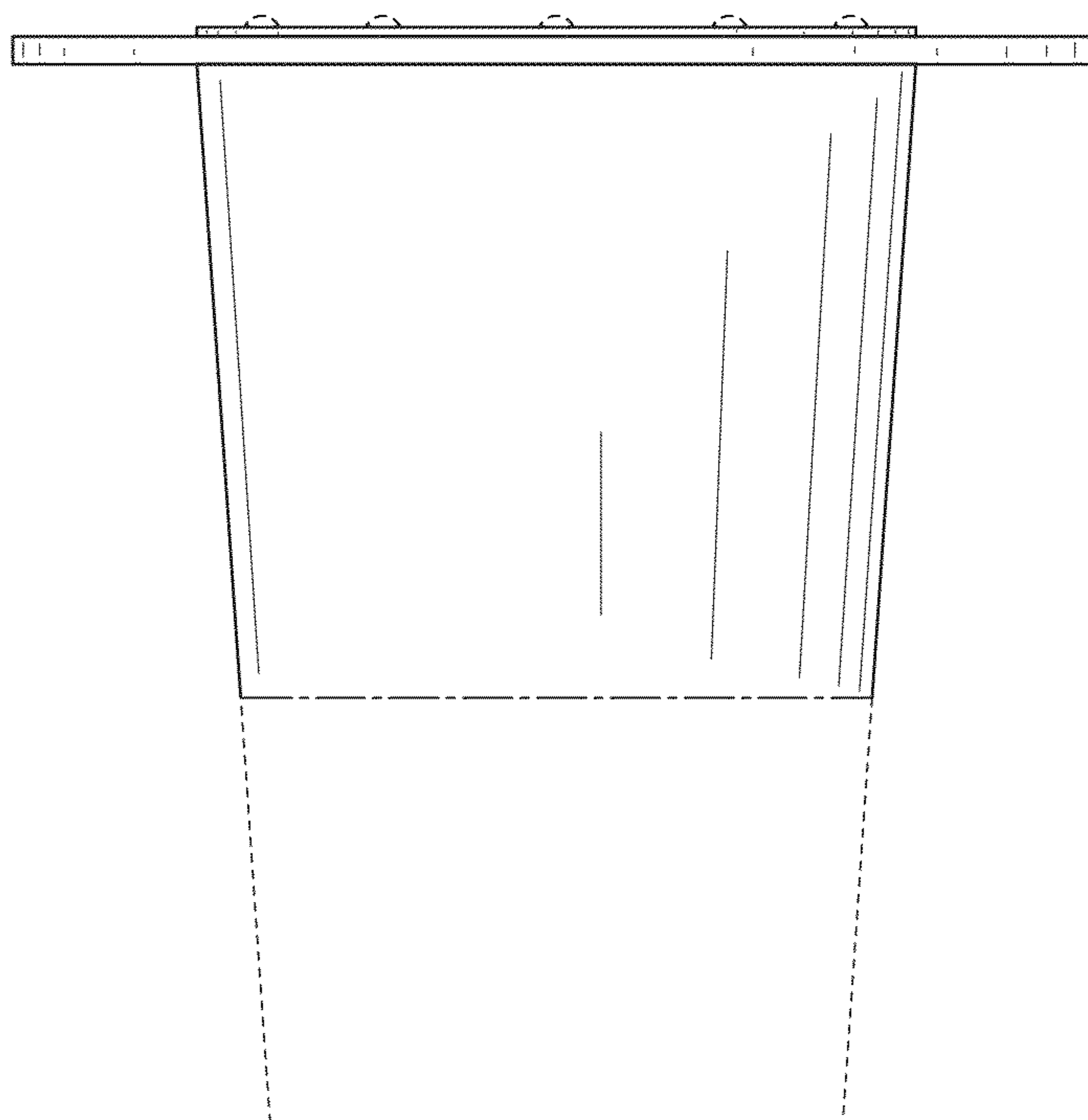

FIG. 12



**FIG. 13**



**FIG. 14**

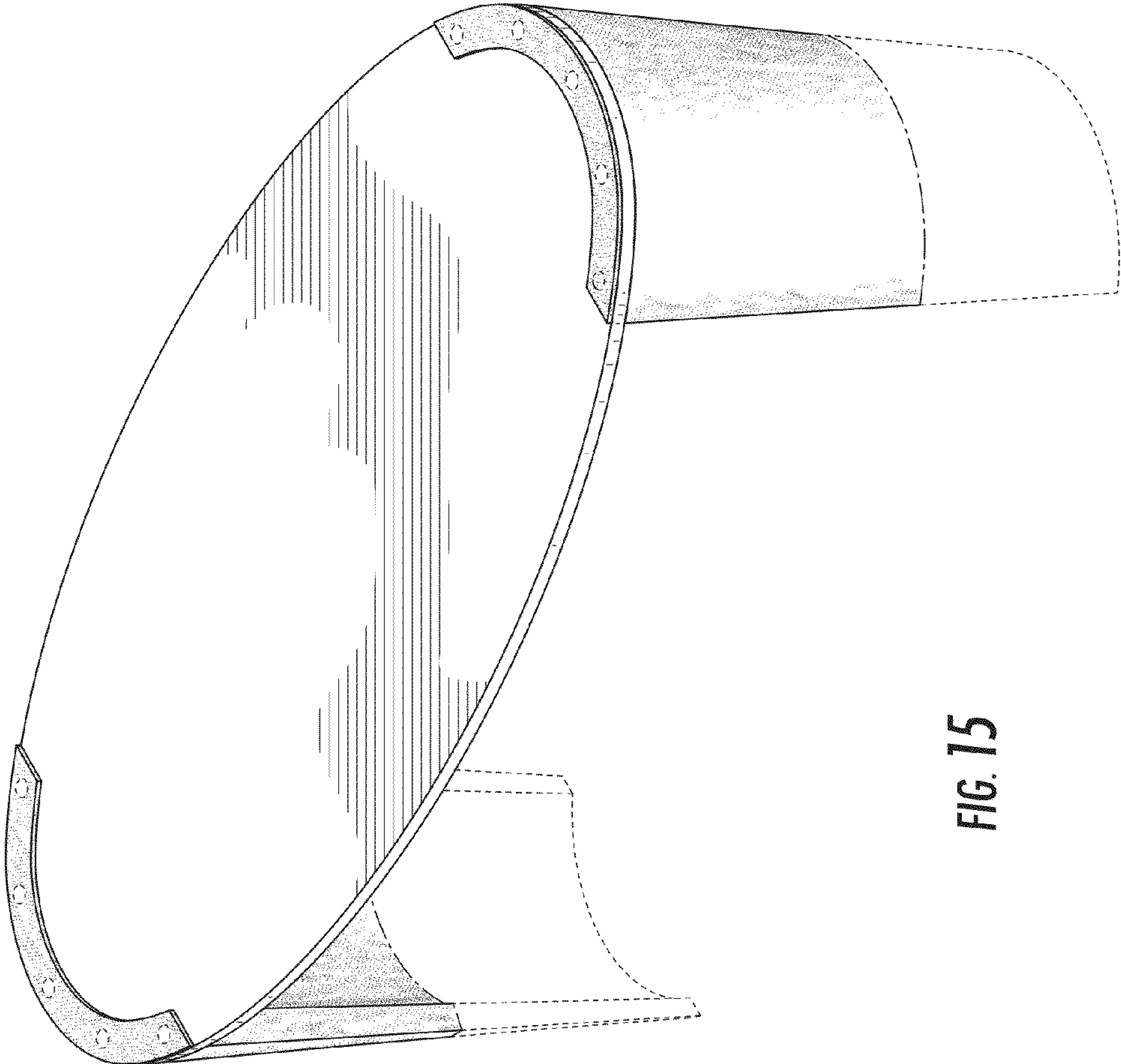

FIG. 15



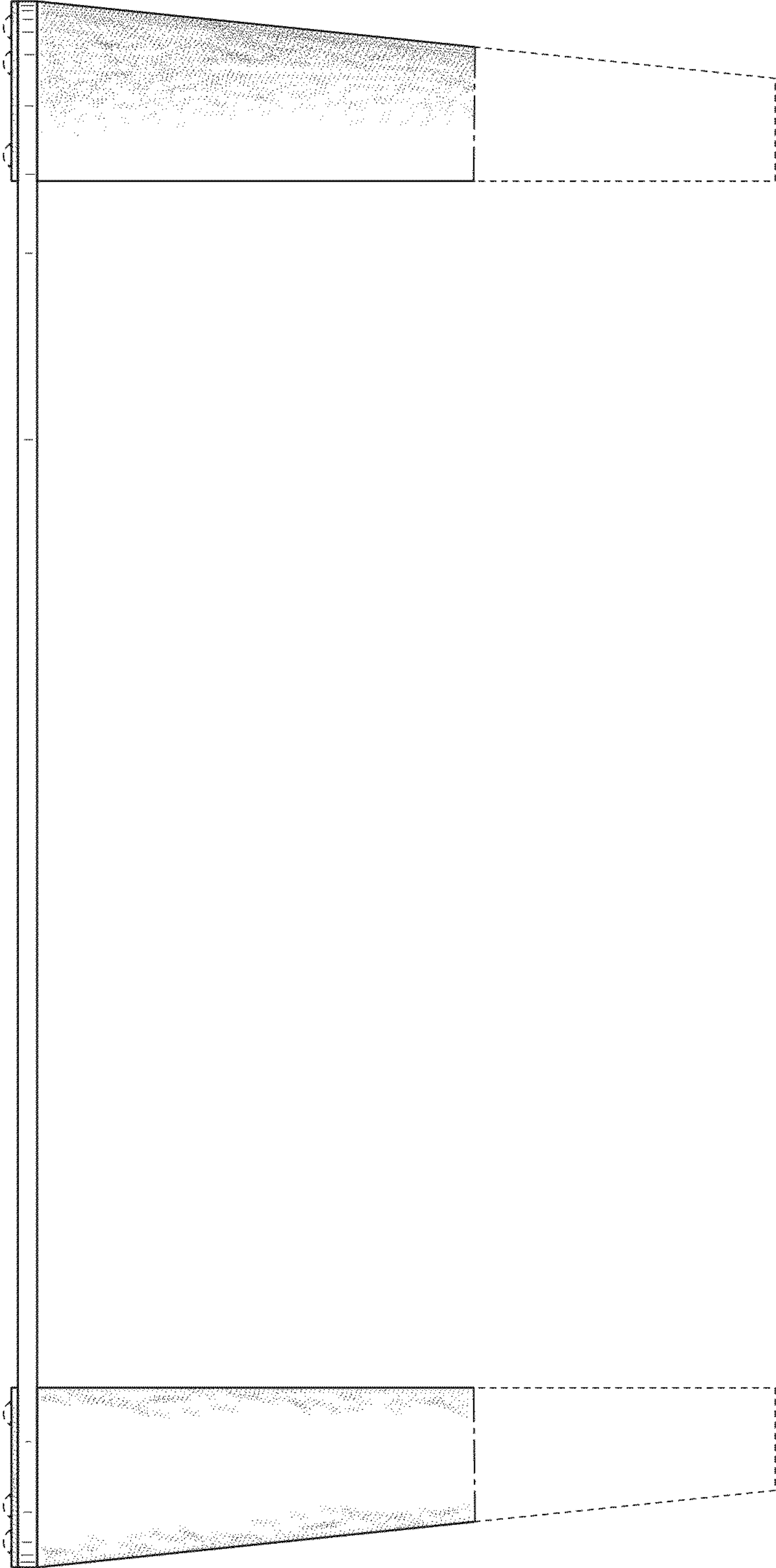

FIG. 16

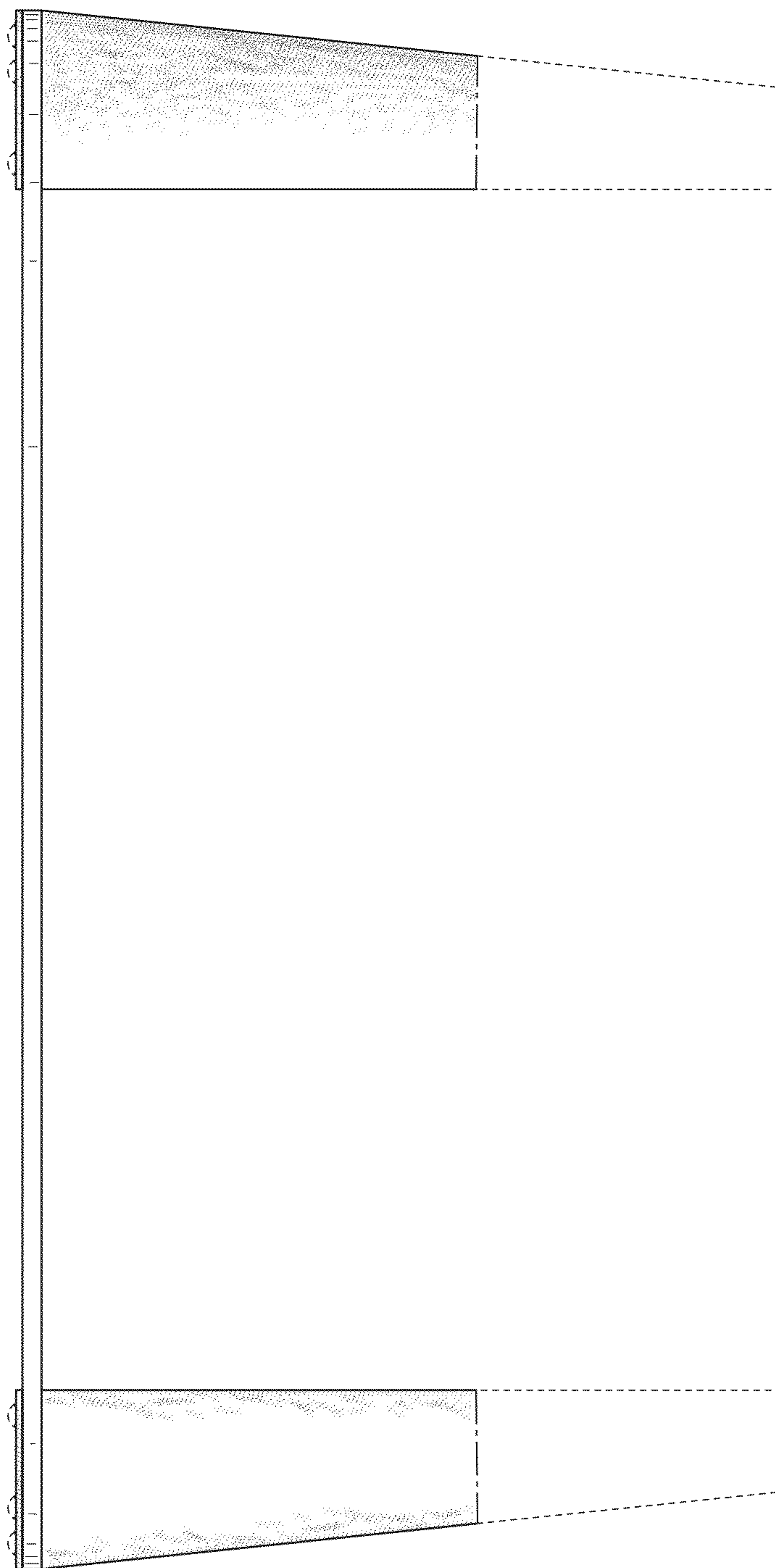

FIG. 17

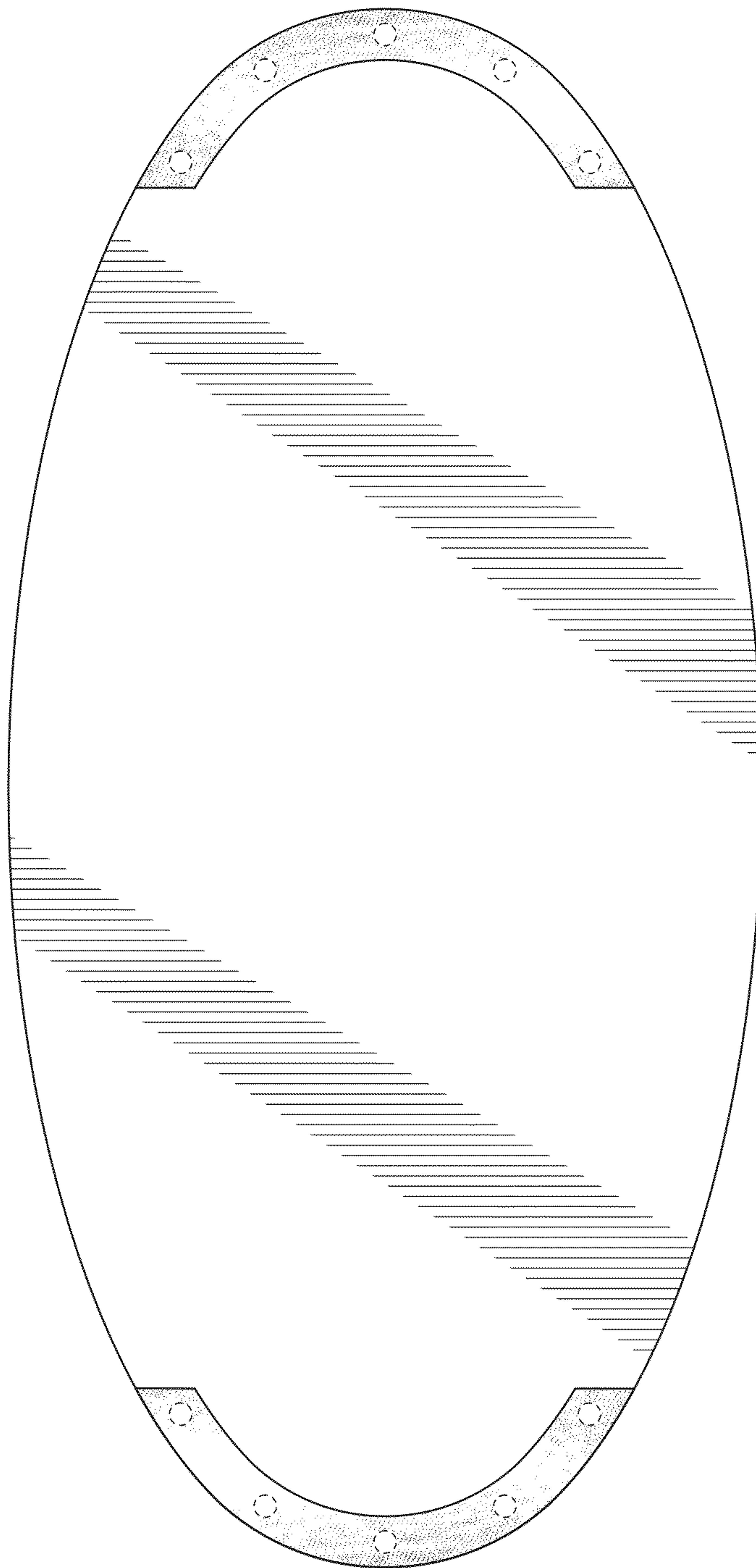

FIG. 18

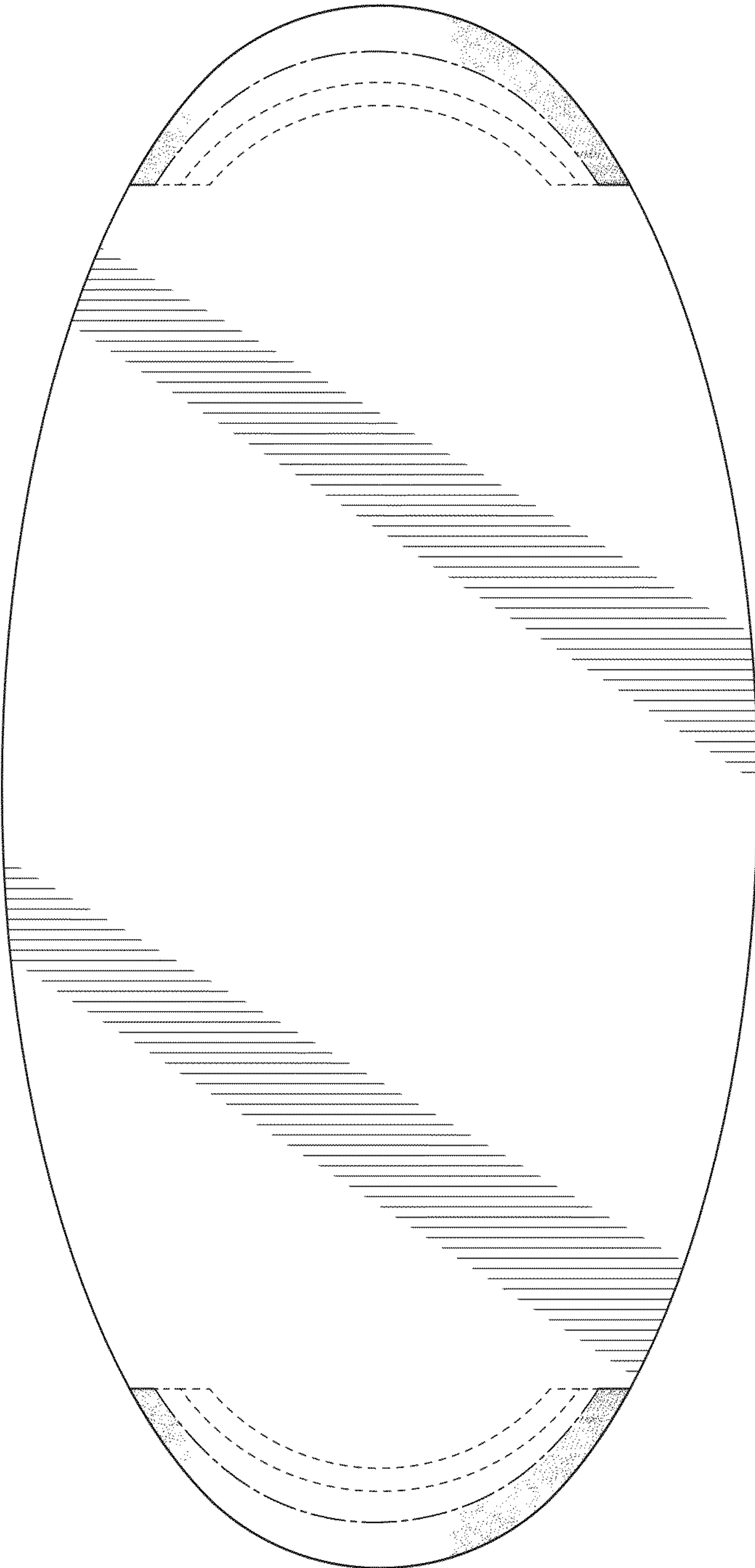
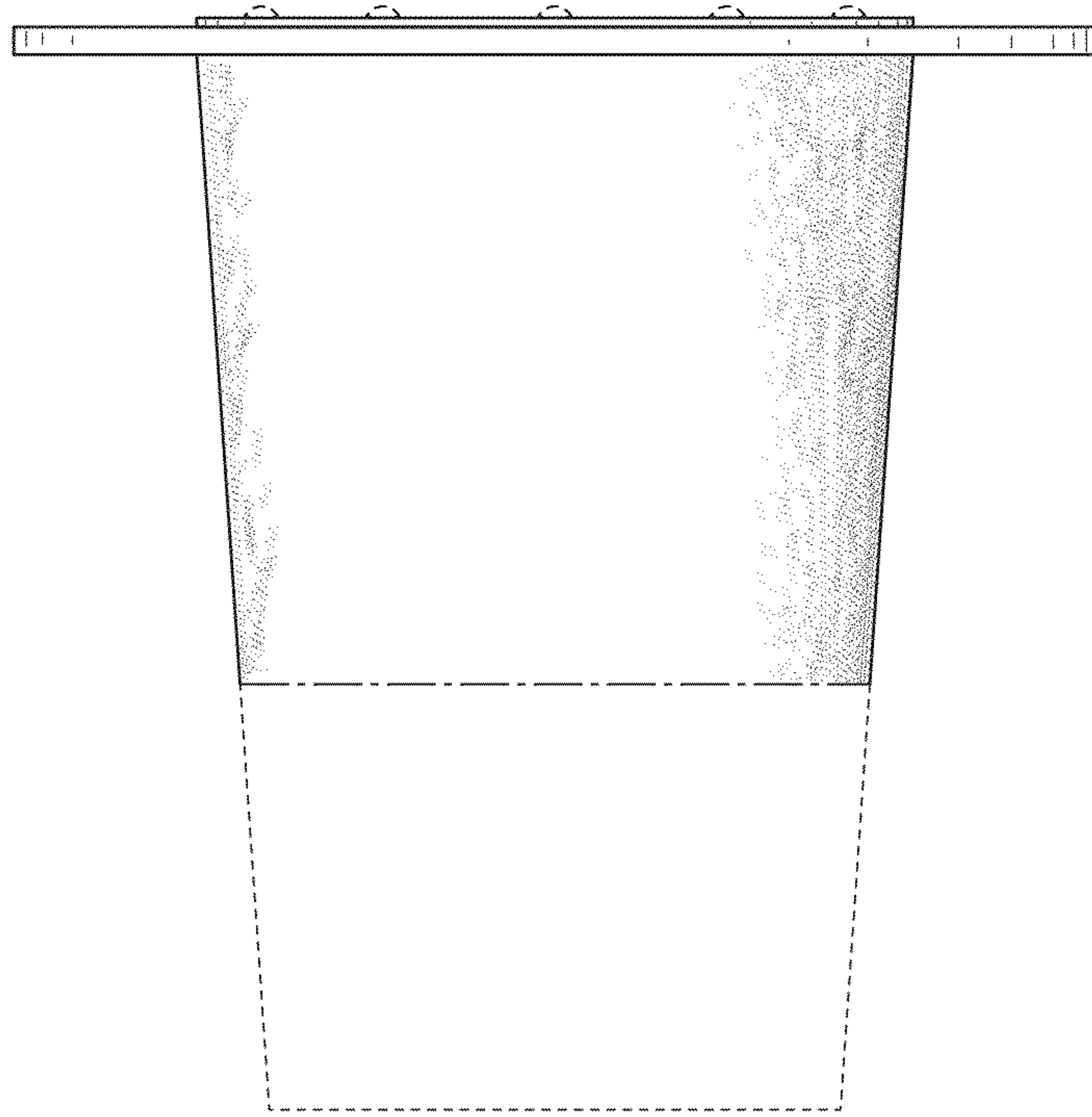
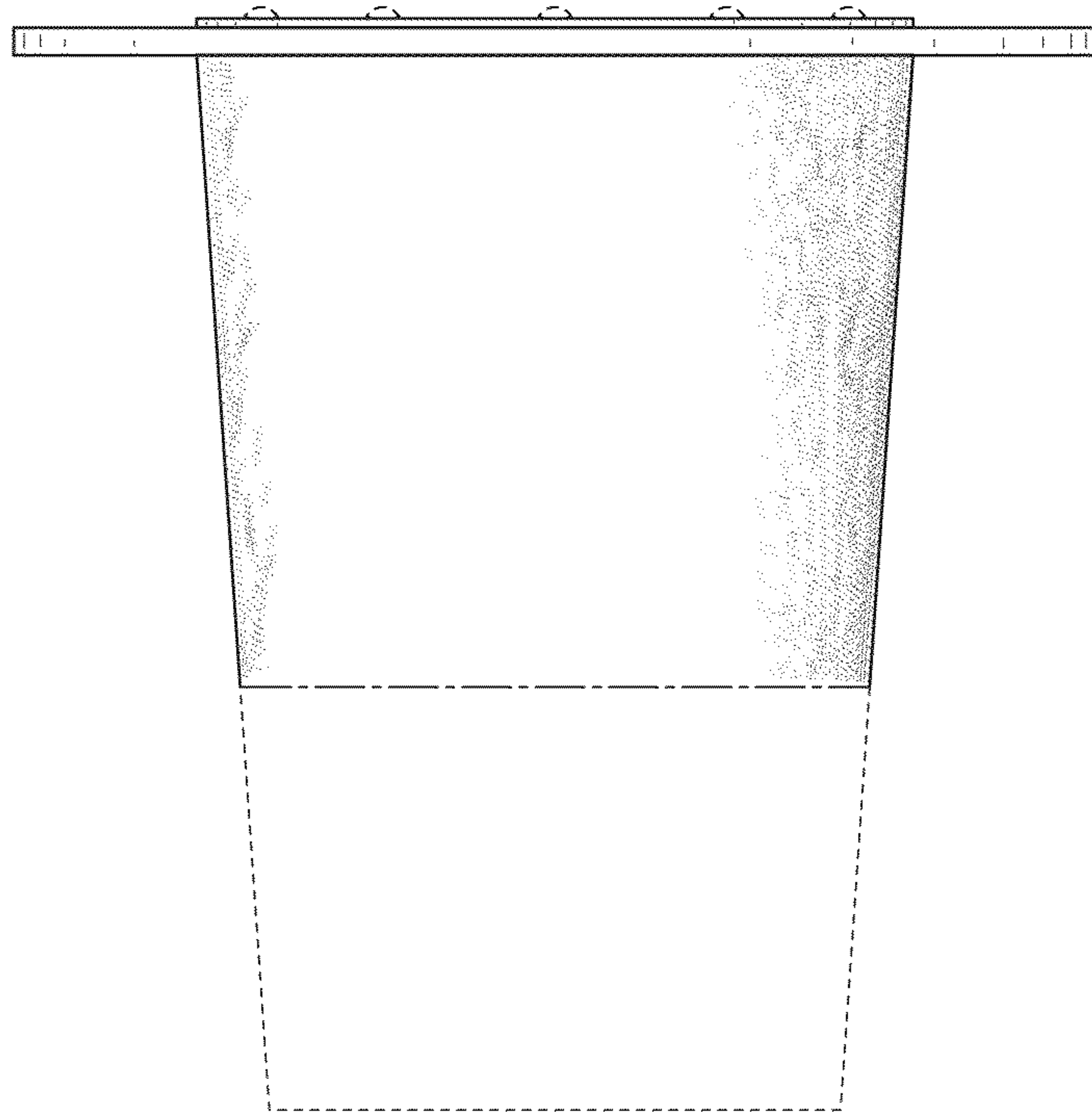

FIG. 19



**FIG. 20**



**FIG. 21**

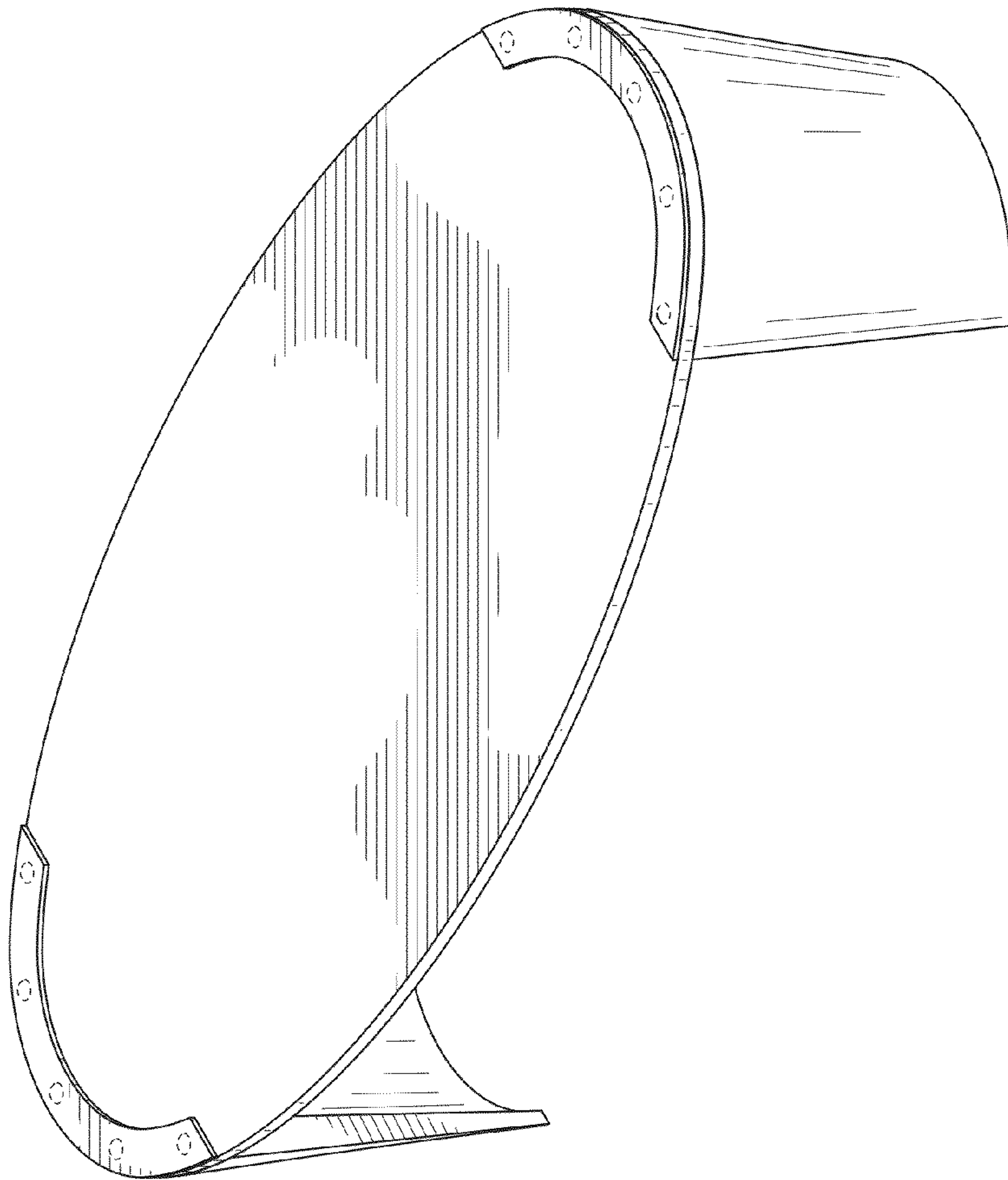

FIG. 22



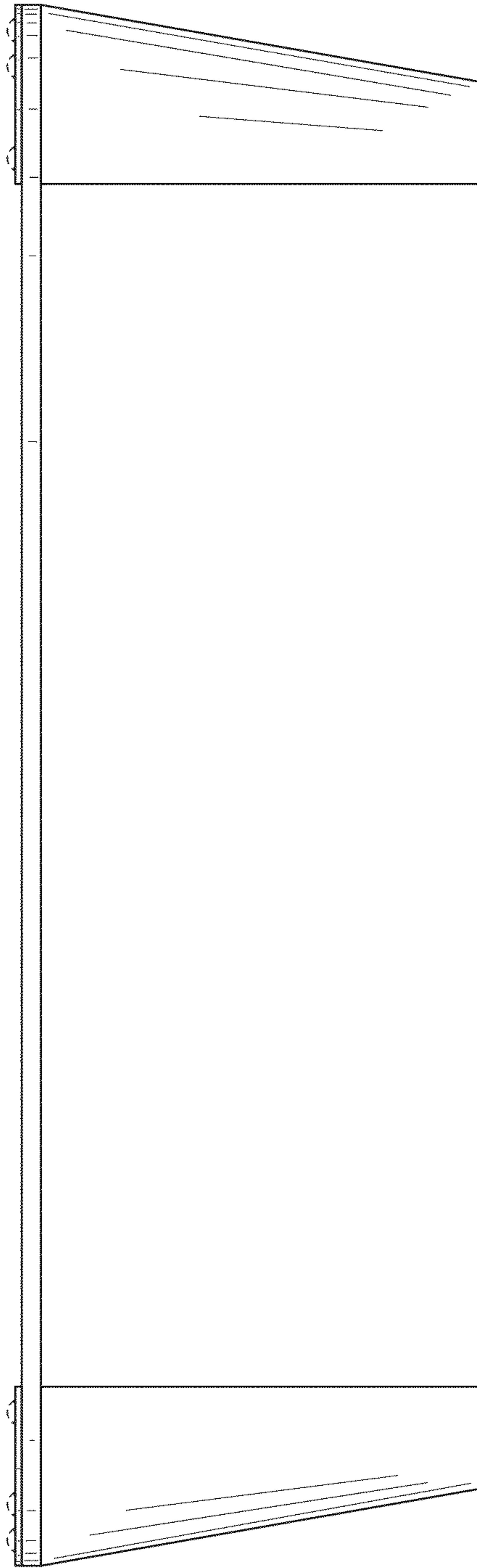

FIG. 23

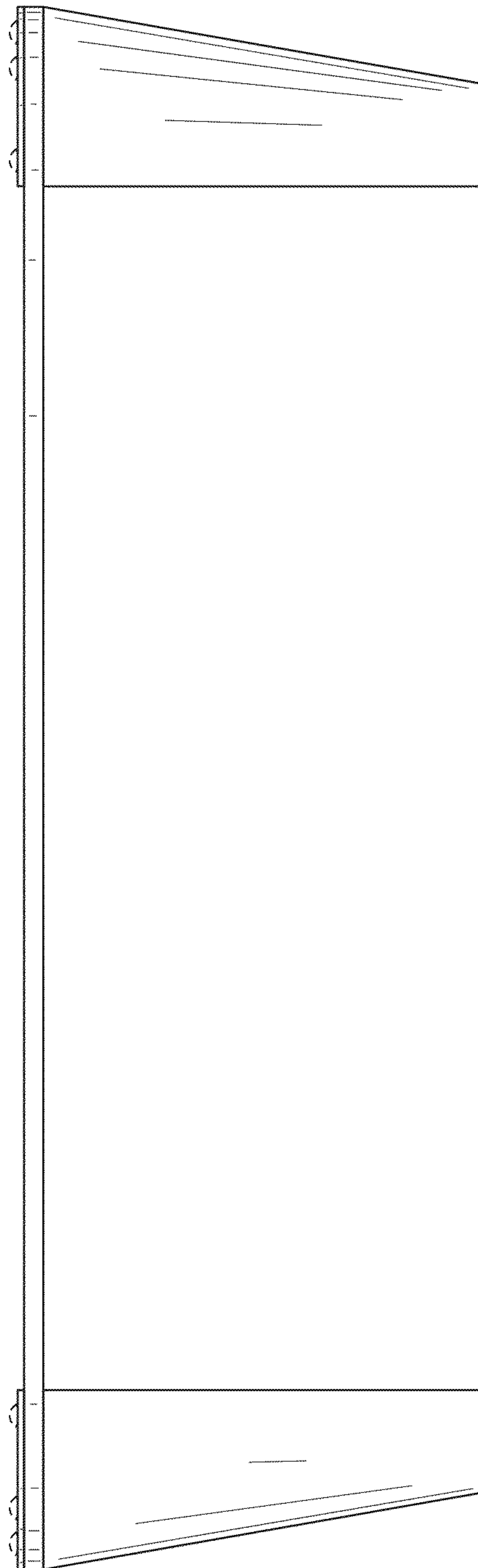

FIG. 24

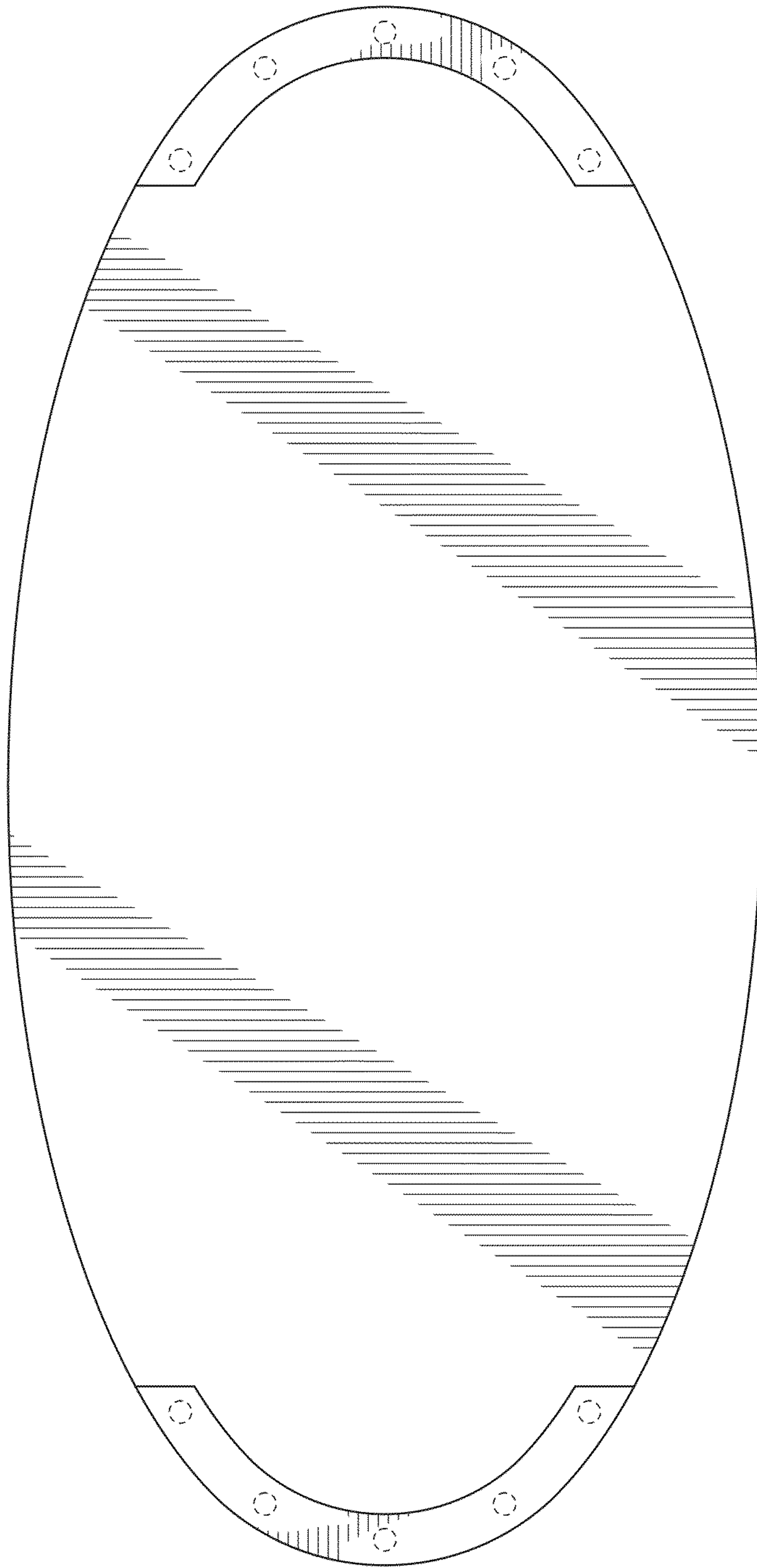

FIG. 25

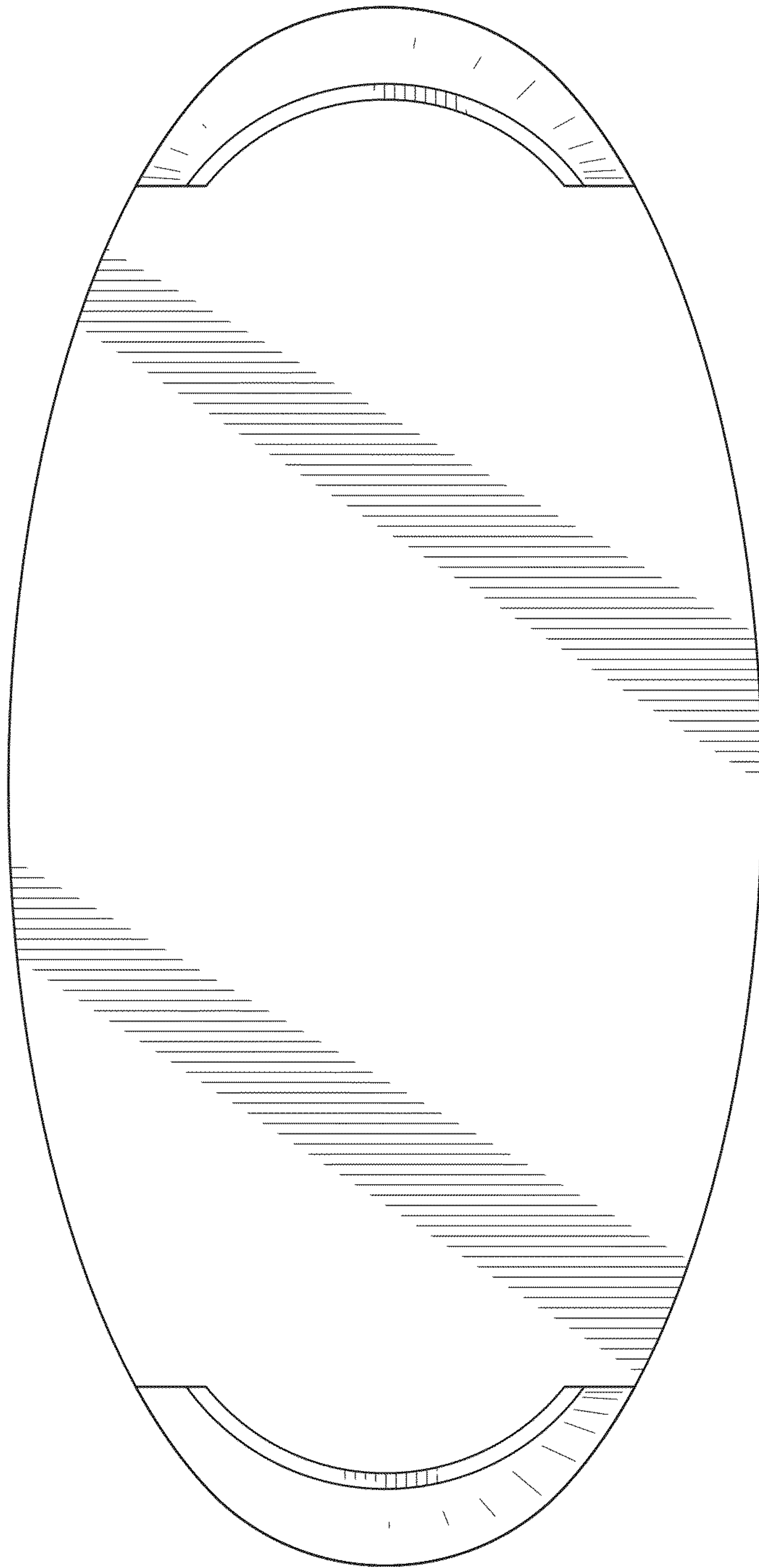
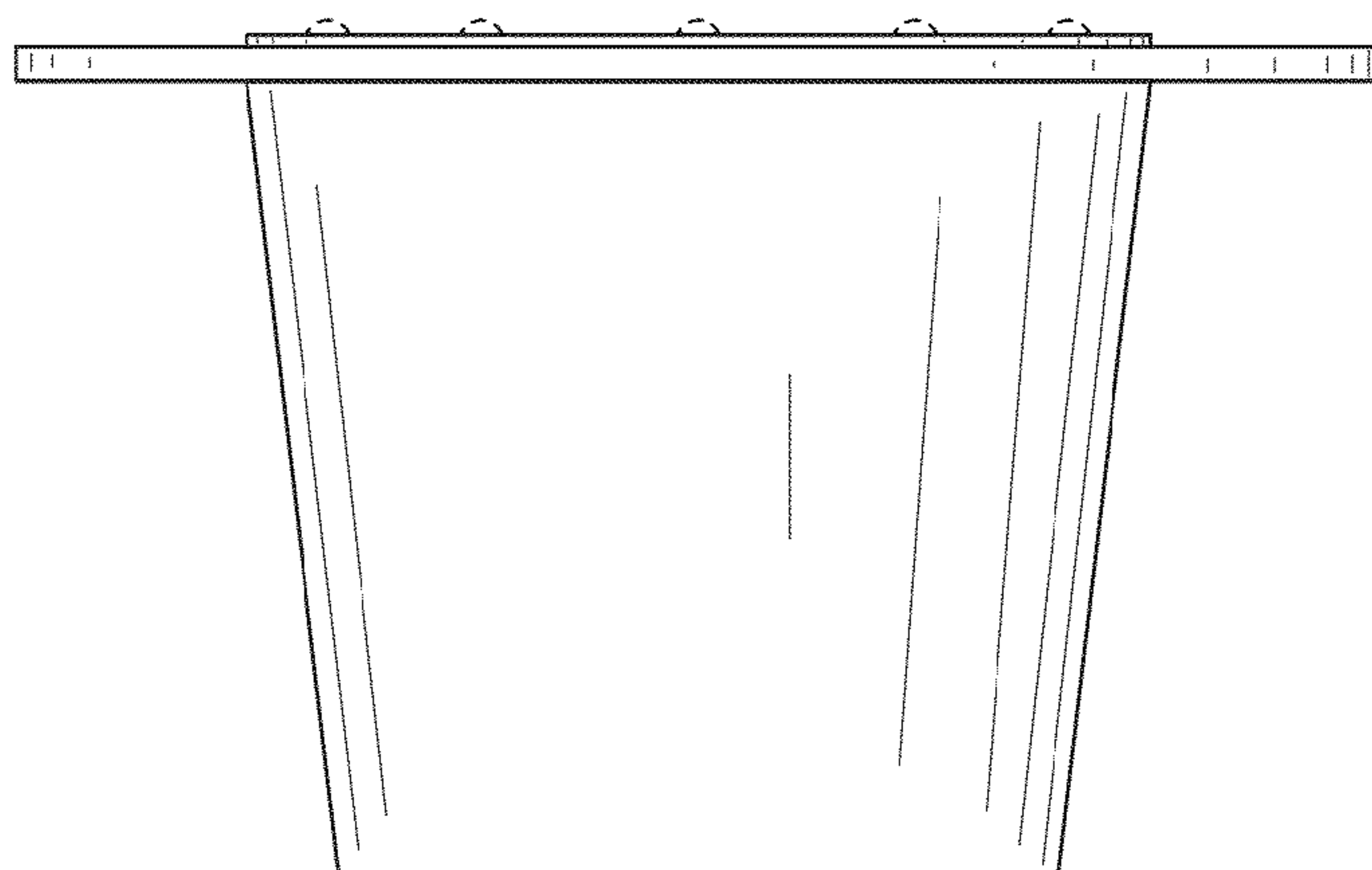
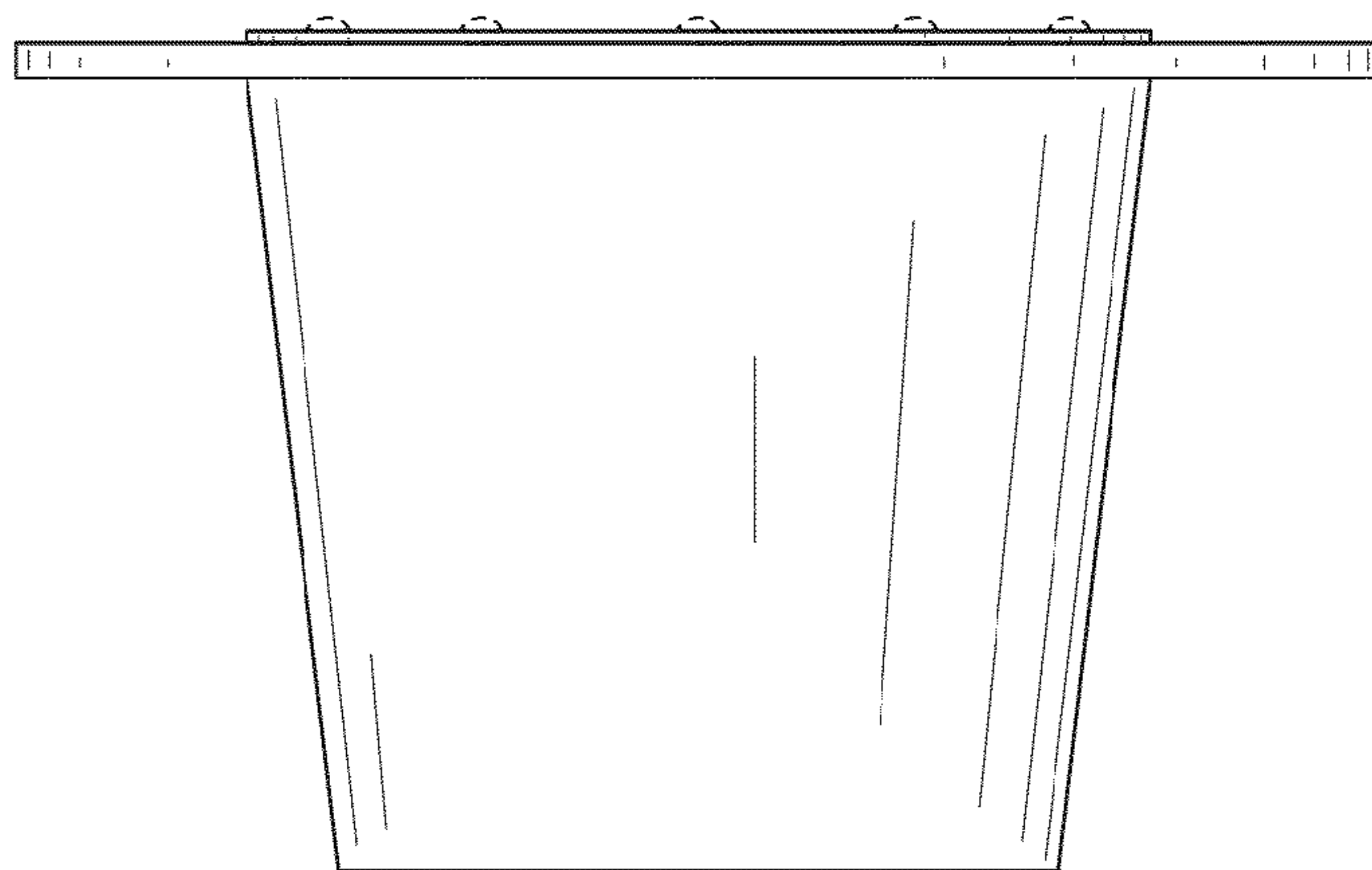

FIG. 26



**FIG. 27**



**FIG. 28**