



US00D749856S

(12) **United States Design Patent**
Lee

(10) **Patent No.:** **US D749,856 S**
(45) **Date of Patent:** **** Feb. 23, 2016**

(54) **COMBINED HAIR BRUSH AND CASE**

2005/0160542 A1 7/2005 Jung
2008/0229532 A1 9/2008 Abodreham
2010/0050352 A1 3/2010 Deris

(76) Inventor: **David M Lee**, Westminster, CA (US)

(**) Term: **14 Years**

FOREIGN PATENT DOCUMENTS

(21) Appl. No.: **29/398,319**

FR 2708439 A1 * 2/1995 A46B 15/00
KR 30-0255164 S * 3/2000

(22) Filed: **Jul. 29, 2011**

* cited by examiner

(51) **LOC (10) Cl.** **04-01**

Primary Examiner — Melanie H Tung

(52) **U.S. Cl.**

Assistant Examiner — Lavone D Tabor

USPC **D4/121**; D4/128

(74) *Attorney, Agent, or Firm* — QuickPatents; Kevin Prince

(58) **Field of Classification Search**

(57) **CLAIM**

USPC D4/121, 127, 128; 15/27, 159.1, 160,
15/184, 186, 187; 132/120, 226, 237, 262,
132/271, 313; 206/361

The ornamental design for a combined hair brush and case, as shown and described.

CPC A46B 9/02; A46B 9/023; A46B 15/0095;
A46B 17/04; A46B 2200/104

DESCRIPTION

See application file for complete search history.

FIG. 1 is a top perspective view of a combined hair brush and case, showing my new design;

(56) **References Cited**

U.S. PATENT DOCUMENTS

D157,258 S * 2/1950 Hertzberg D4/121
4,009,725 A 3/1977 Stuart
4,277,193 A 7/1981 Knaus
4,386,620 A * 6/1983 Handler 132/313
D309,376 S * 7/1990 Kiesz D4/128
6,213,129 B1 4/2001 Muldoon
D502,815 S * 3/2005 Wang D4/128
D538,046 S 3/2007 Tsaor
D562,004 S 2/2008 Petruccelli, Sr.
D584,608 S * 1/2009 McBride D9/418
8,127,393 B1 * 3/2012 Dockter 15/184

FIG. 2 is an exploded bottom perspective view thereof;

FIG. 3 is an exploded front elevational view thereof, the rear elevational view, left-side elevational view, and right-side elevational view all being a mirror image thereof;

FIG. 4 is a top plan view of the hair brush, the case being omitted for clarity of illustration only; and,

FIG. 5 is top plan view thereof; and,

FIG. 6 is a bottom plan view thereof.

The shading on the top surface of the design in FIGS. 1 and 5 denotes a reflective surface. The areas shown in broken lines in FIGS. 2, 4 and 6 form no part of the claimed design.

1 Claim, 3 Drawing Sheets

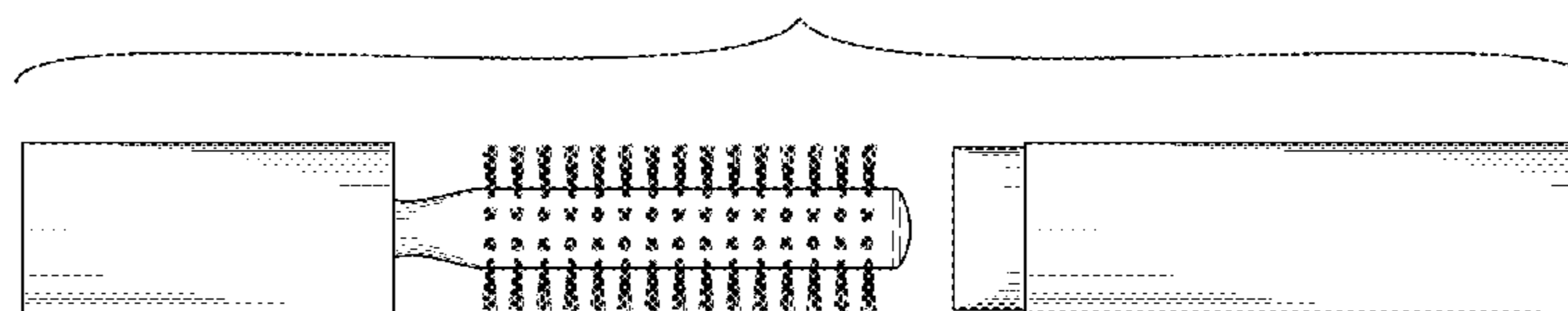
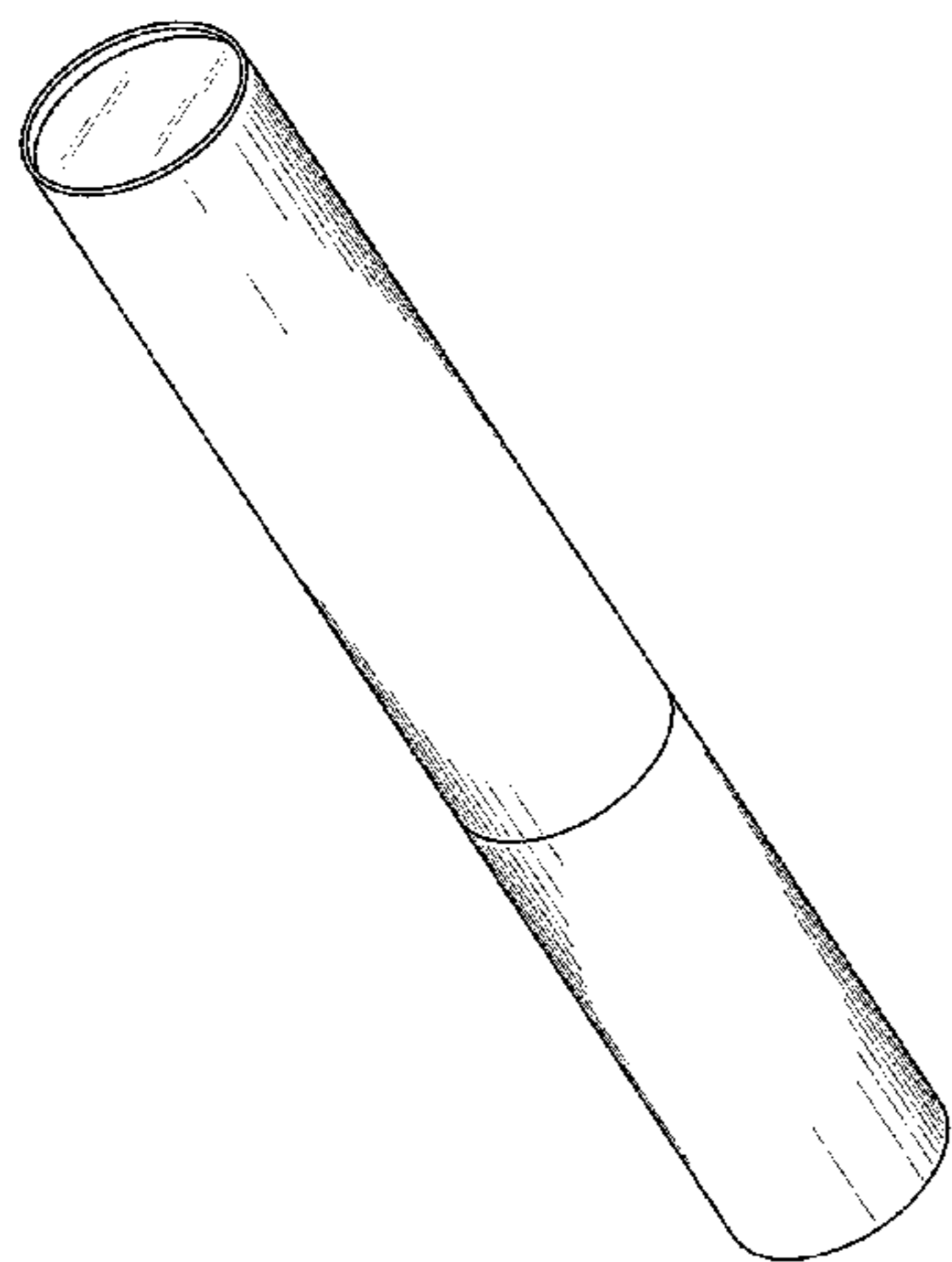

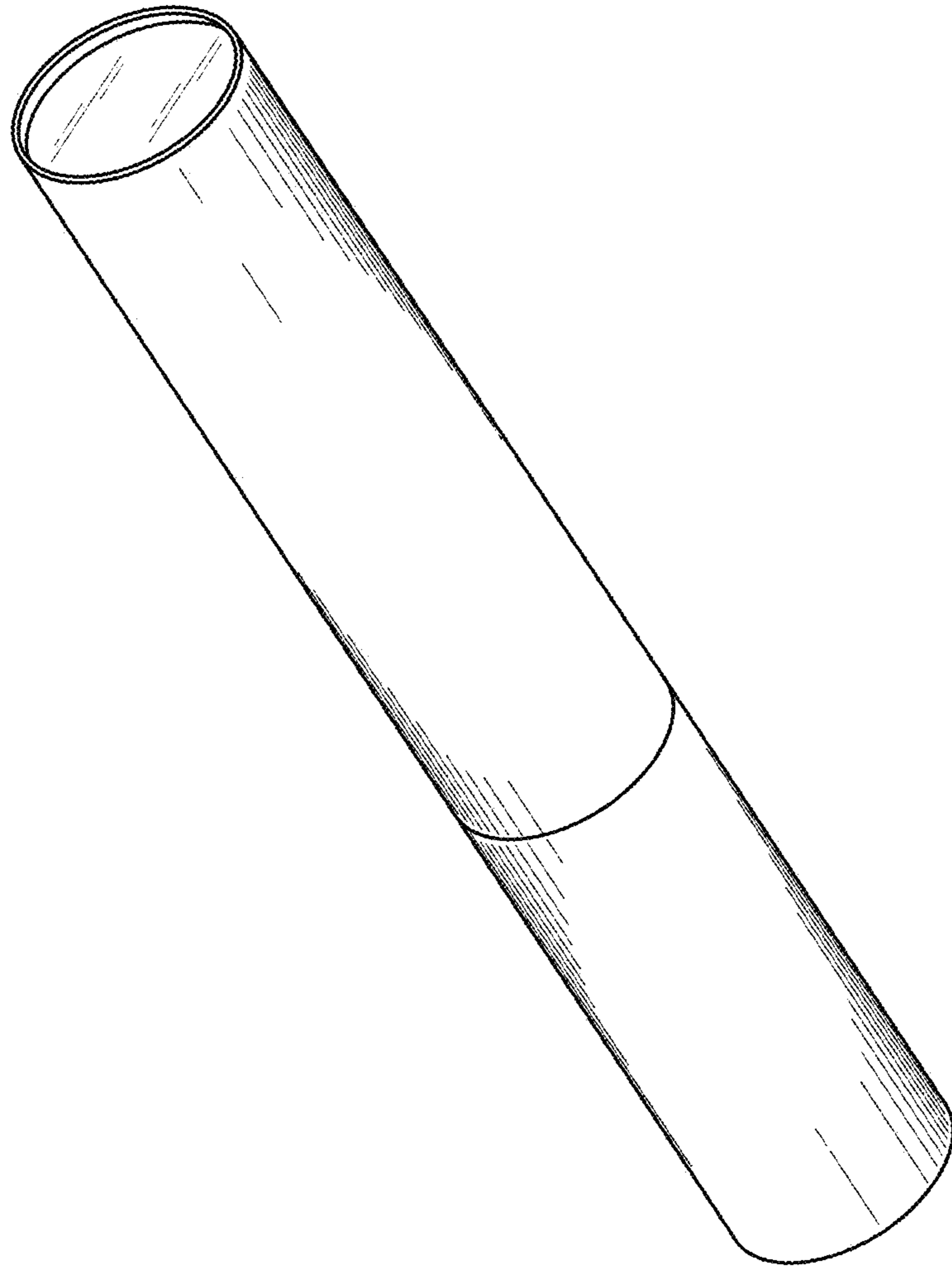

FIG. 1

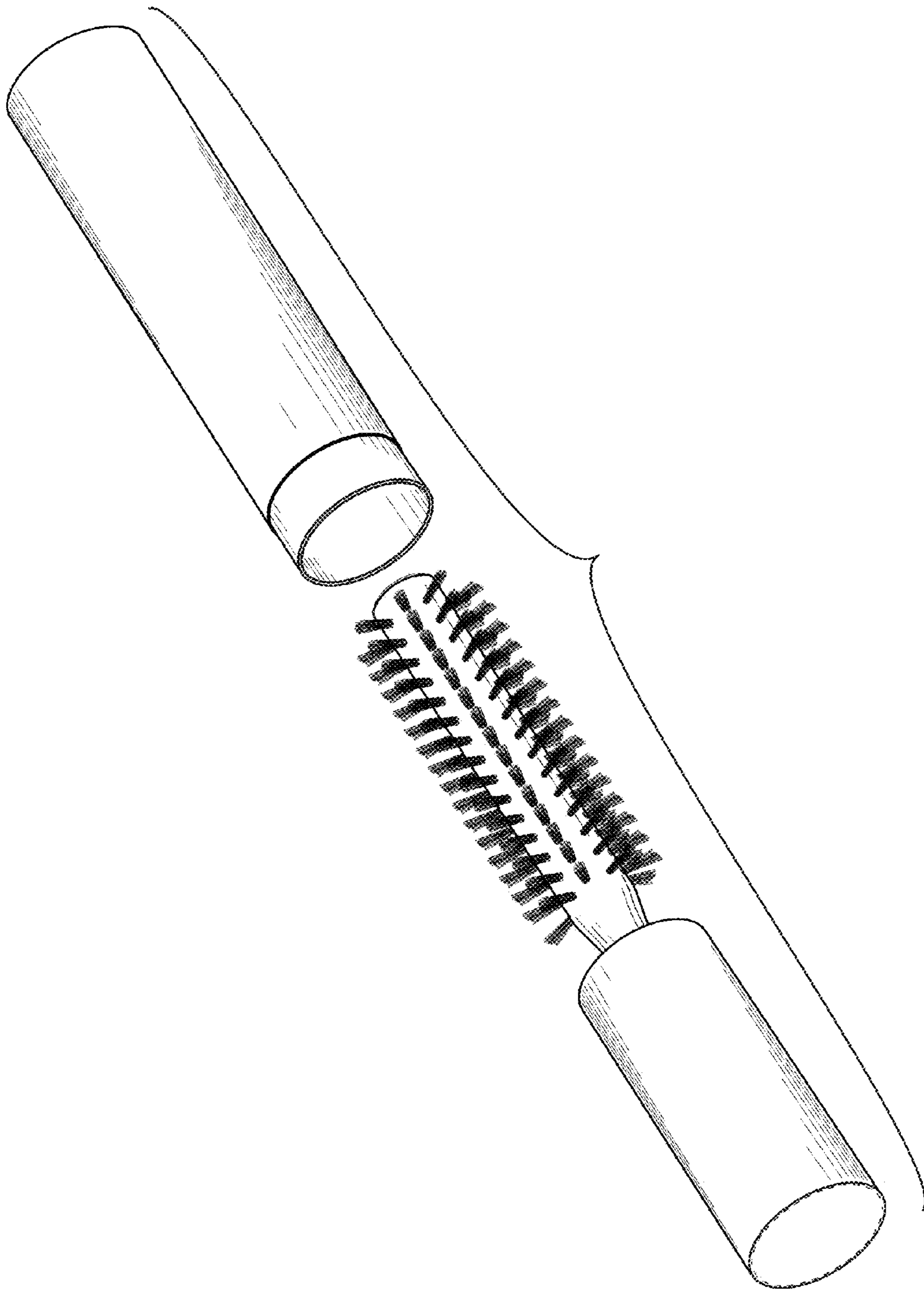

FIG. 2

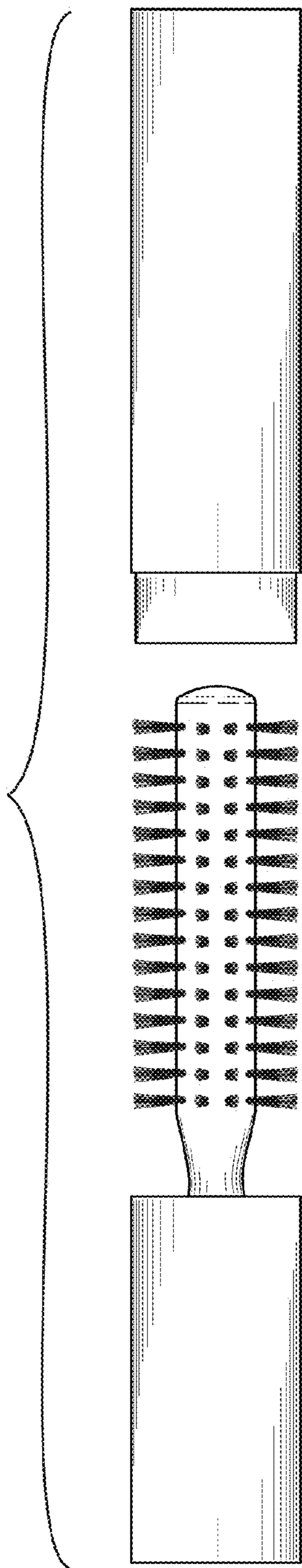

FIG. 3

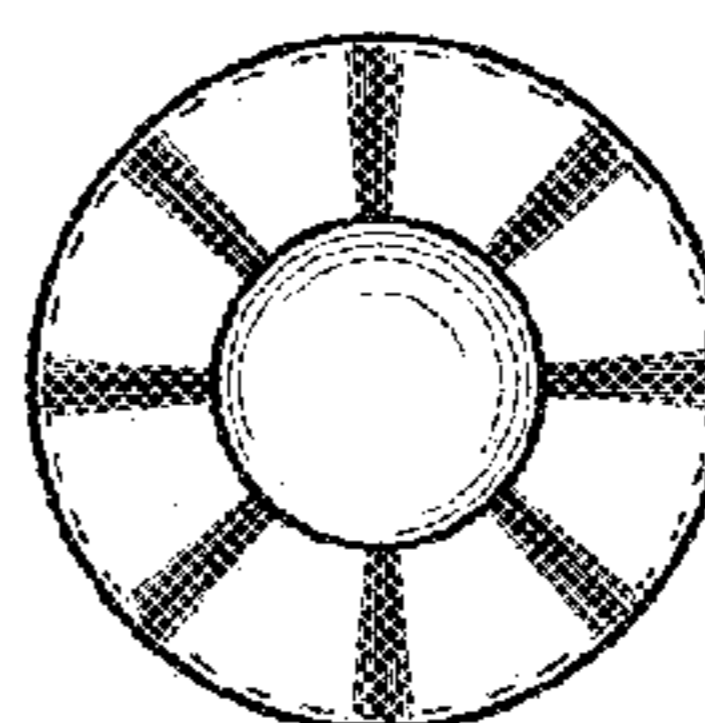

FIG. 4

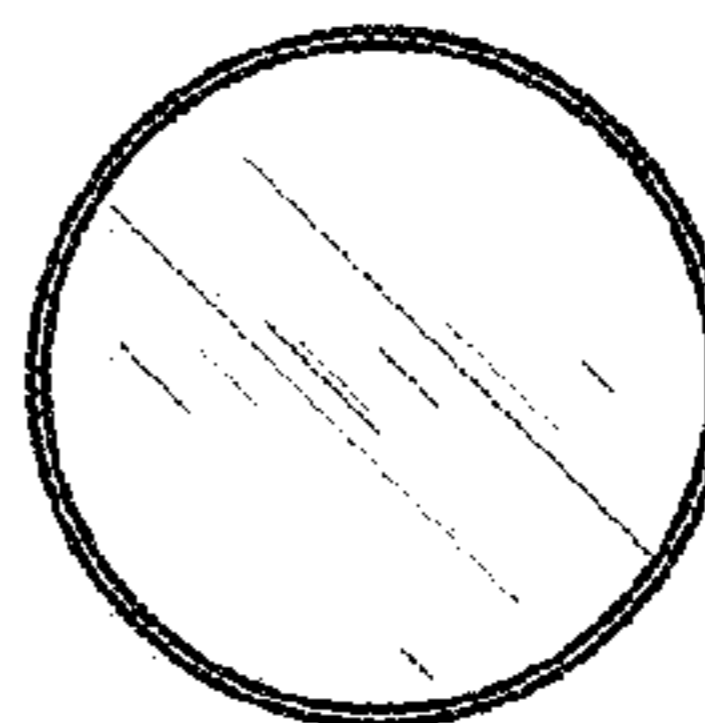

FIG. 5

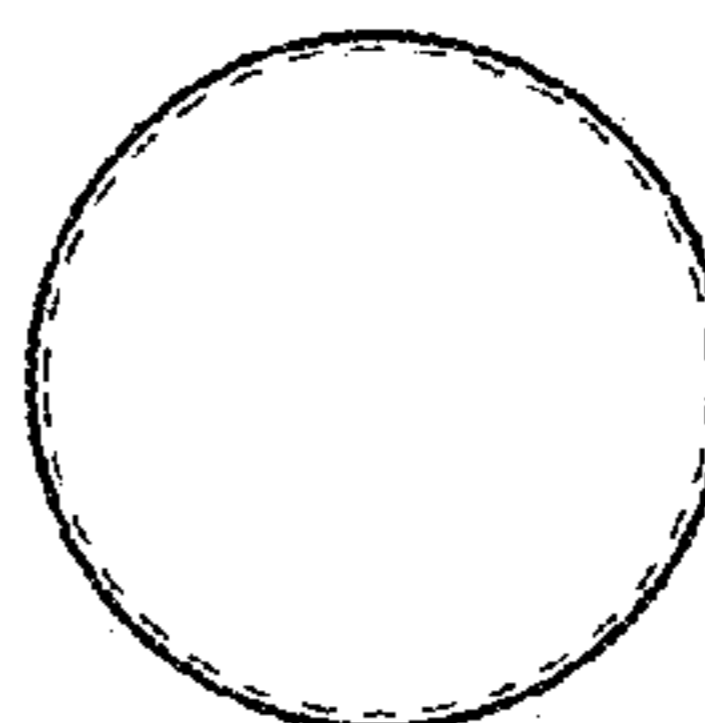

FIG. 6