



US00D749808S

(12) **United States Design Patent**  
**Leduc et al.**

(10) **Patent No.:** **US D749,808 S**  
(45) **Date of Patent:** **\*\* Feb. 16, 2016**

(54) **WASTE RECEPTACLE WITH EXTENSION**  
(71) Applicants: **Stéphane Leduc**, Charlotte, NC (US);  
**Holger Kappler**, Pfalzgrafenweiler (DE)  
(72) Inventors: **Stéphane Leduc**, Charlotte, NC (US);  
**Holger Kappler**, Pfalzgrafenweiler (DE)  
(73) Assignees: **Sirona Dental, Inc.**, Long Island City,  
NY (US); **Kappler Med+Org GmbH**,  
Pfalzgrafenweiler (DE)

8,522,993 B2 \* 9/2013 Flewelling ..... B65F 1/006  
220/255  
8,622,493 B2 \* 1/2014 Roeck ..... A47B 77/18  
312/330.1  
9,081,887 B2 \* 7/2015 Olson ..... G07F 17/0092

\* cited by examiner

*Primary Examiner* — Cynthia Ramirez

(74) *Attorney, Agent, or Firm* — Fitzpatrick, Cella, Harper & Scinto

(\*\*) Term: **14 Years**

(21) Appl. No.: **29/482,829**

(22) Filed: **Feb. 21, 2014**

(51) **LOC (10) Cl.** ..... **09-09**

(52) **U.S. Cl.**  
USPC ..... **D34/1**

(58) **Field of Classification Search**  
USPC ..... D34/1-11; 220/908, 908.1; D6/671,  
D6/671.1  
CPC ..... A47B 77/08; A47B 77/04; B65F 1/006;  
B65F 1/02; B65F 1/04  
See application file for complete search history.

(57) **CLAIM**

The ornamental design for a waste receptacle with extension,  
as shown and described.

**DESCRIPTION**

FIG. 1 is a left, top, and front perspective view of a waste receptacle with extension showing an extension in a retracted position and a bottom drawer in a closed position;  
FIG. 2 is a left side view of the waste receptacle with extension shown in FIG. 1, the right side view being a mirror image of FIG. 2;  
FIG. 3 is a front view of the waste receptacle with extension shown in FIG. 1;  
FIG. 4 is a top view of the waste receptacle with extension shown in FIG. 1;  
FIG. 5 is a bottom view of the waste receptacle with extension shown in FIG. 1;  
FIG. 6 is a rear view of the waste receptacle with extension shown in FIG. 1;  
FIG. 7 is a left, top, and front perspective view of the waste receptacle with extension showing the extension in the retracted position and the bottom drawer in an opened position, the rear view of the waste receptacle with extension being identical to the rear view shown in FIG. 6;  
FIG. 8 is a left side view of the waste receptacle with extension shown in FIG. 7, the right side view being a mirror image of FIG. 8;  
FIG. 9 is a front view of the waste receptacle with extension shown in FIG. 7;  
FIG. 10 is a top view of the waste receptacle with extension shown in FIG. 7;

(56) **References Cited**

**U.S. PATENT DOCUMENTS**

2,950,158 A \* 8/1960 Harmon ..... A47B 77/04  
312/213  
3,528,718 A \* 9/1970 Braun ..... A47B 77/18  
312/270.3  
5,076,458 A \* 12/1991 Weiner ..... B65F 1/006  
220/23.86  
D330,102 S \* 10/1992 Gunn ..... D34/7  
D333,197 S \* 2/1993 Scheinberg ..... D34/1  
5,218,782 A \* 6/1993 Null ..... A01M 13/003  
220/908  
5,634,702 A \* 6/1997 Fistonich ..... A47B 77/18  
312/270.3  
5,938,305 A \* 8/1999 Rubsam-Tomlinson A47B 81/00  
220/909  
6,209,978 B1 \* 4/2001 Khan ..... B65F 1/006  
312/270.3  
7,654,443 B1 \* 2/2010 Fuller ..... B65F 1/06  
220/908

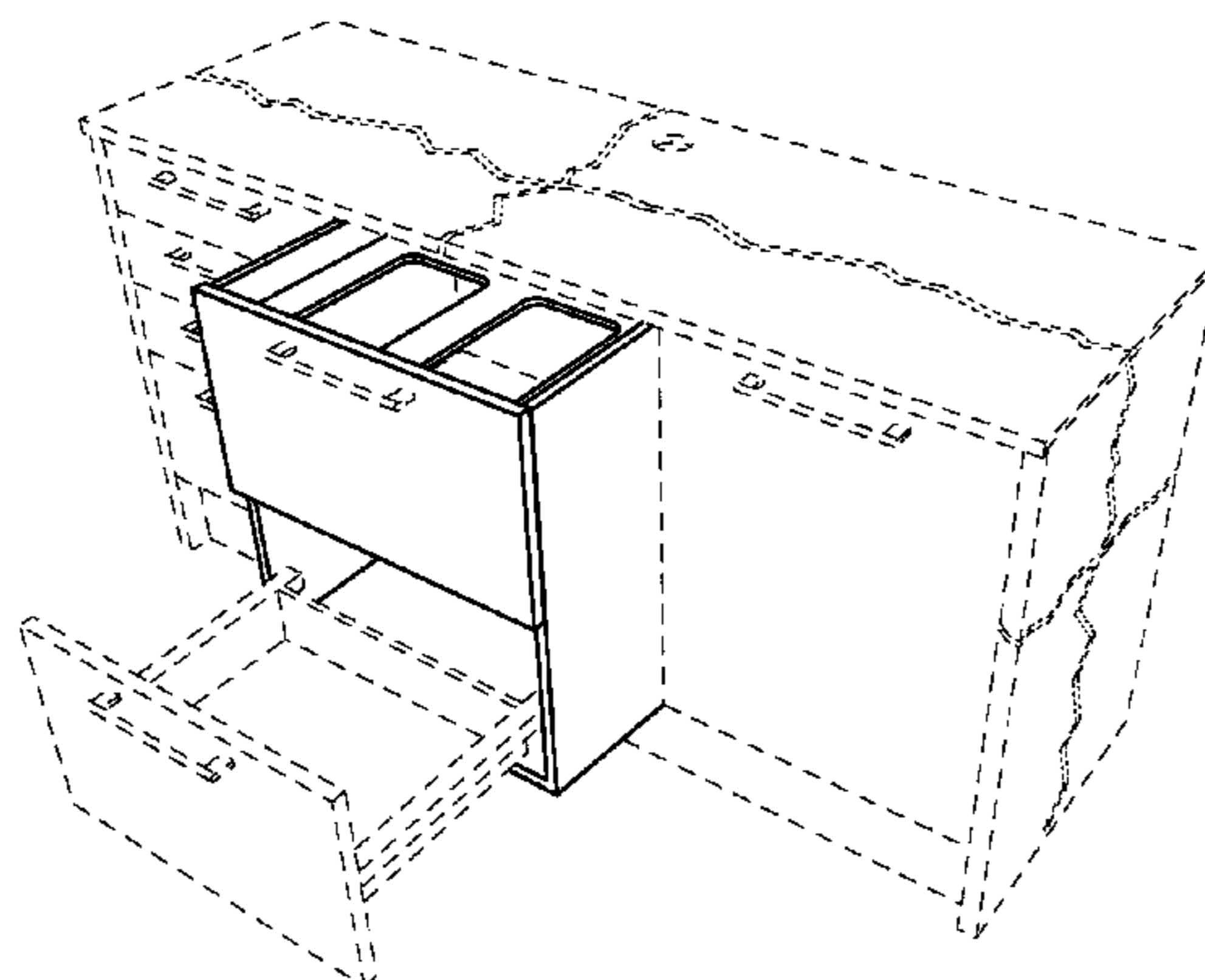

FIG. 11 is a bottom view of the waste receptacle with extension shown in FIG. 7;

FIG. 12 is a left, top, and front perspective view of the waste receptacle with extension showing the extension in an extended position and the bottom drawer in the closed position, revealing waste receptacle openings in an upper portion of the extension, the rear view of the waste receptacle with extension being identical to the rear view shown in FIG. 6;

FIG. 13 is a left side view of the waste receptacle with extension shown in FIG. 12, the right side view being a mirror image of FIG. 13;

FIG. 14 is a front view of the waste receptacle with extension shown in FIG. 12;

FIG. 15 is a top view of the waste receptacle with extension shown in FIG. 12;

FIG. 16 is a bottom view of the waste receptacle with extension shown in FIG. 12;

FIG. 17 is a left, top, and front perspective view of the waste receptacle with extension showing the extension in the extended position and the bottom drawer in the opened posi-

tion, revealing the waste receptacle openings in the upper portion of the extension, the rear view of the waste receptacle with extension being identical to the rear view shown in FIG. 6;

FIG. 18 is a left side view of the waste receptacle with extension shown in FIG. 17, the right side view being a mirror image of FIG. 18;

FIG. 19 is a front view of the waste receptacle with extension shown in FIG. 17;

FIG. 20 is a top view of the waste receptacle with extension shown in FIG. 17; and,

FIG. 21 is a bottom view of the waste receptacle with extension shown in FIG. 17.

The broken lines shown in the figures are included for the purpose of illustrating environment and form no part of the claimed design. The jagged dot-dash lines in the figures indicate that any portion of the article beyond what is shown forms no part of the claimed design.

**1 Claim, 21 Drawing Sheets**

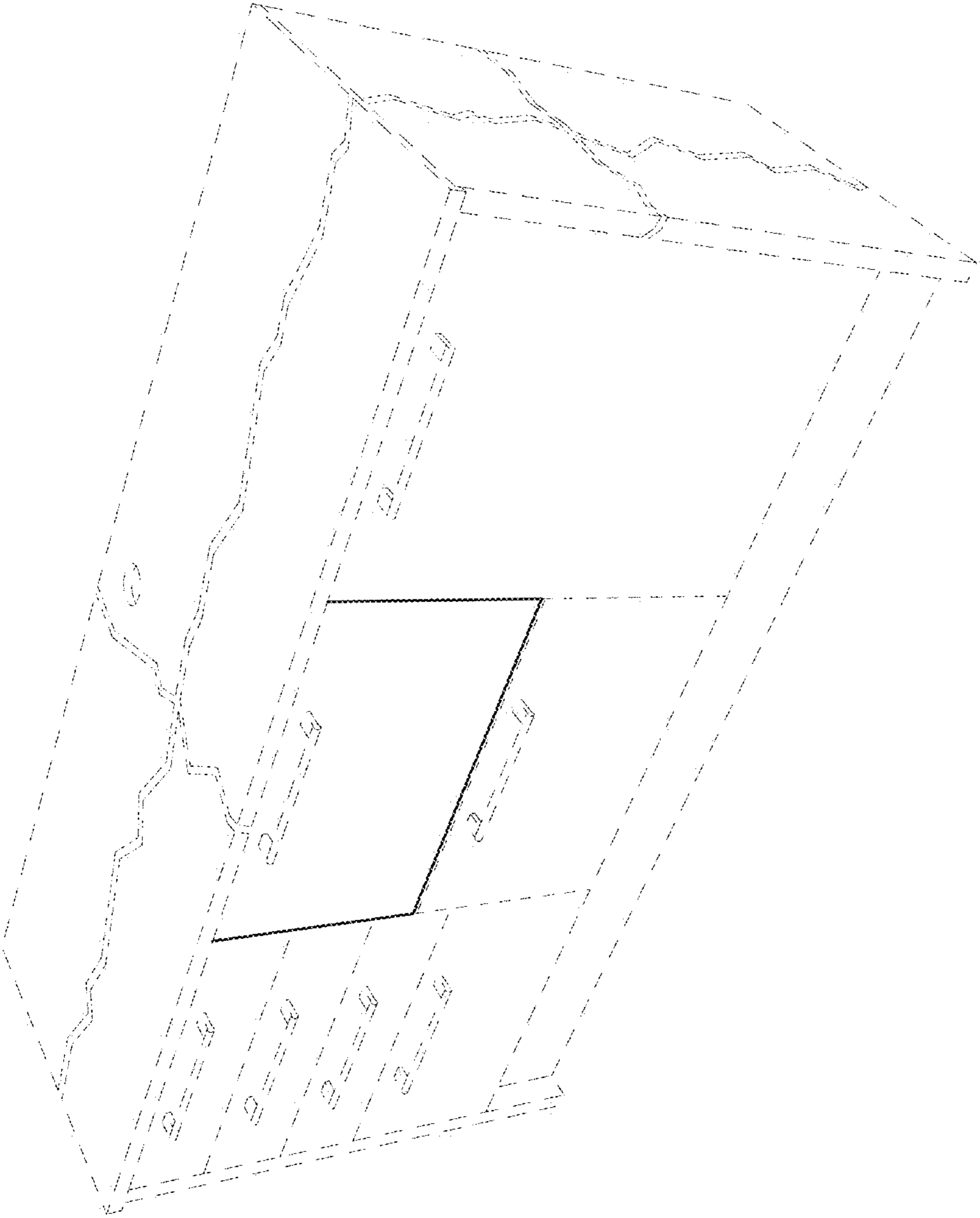

FIG. 1

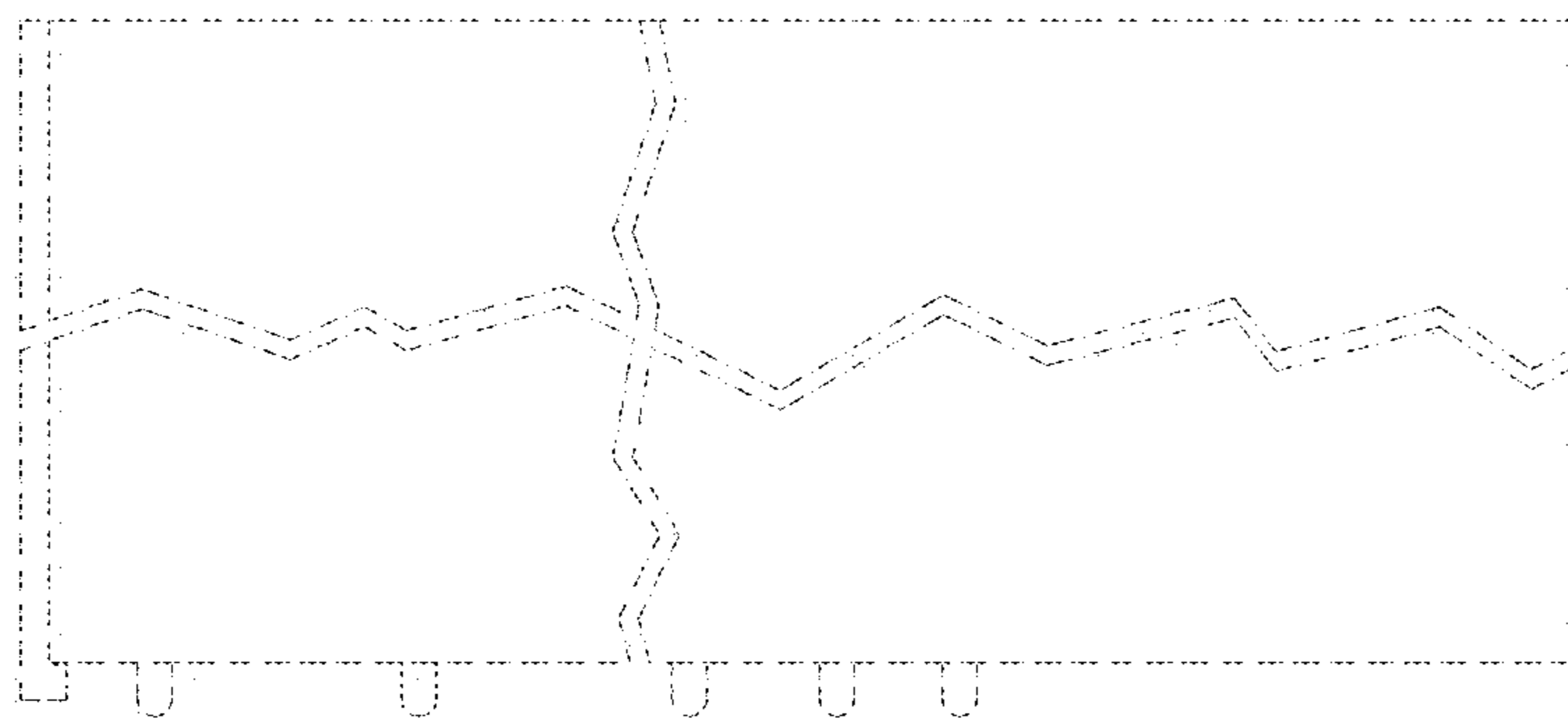

FIG. 2

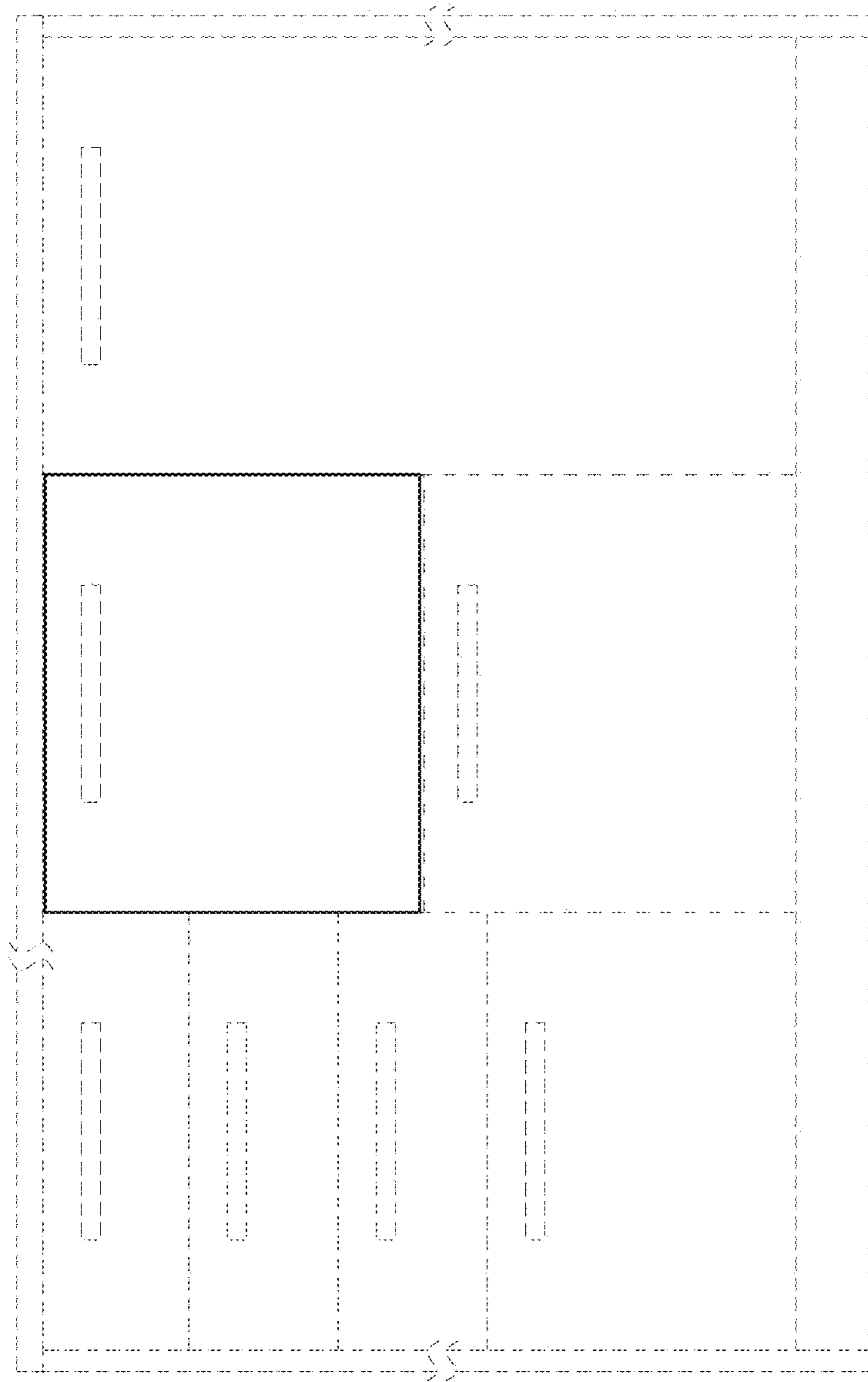

FIG. 3

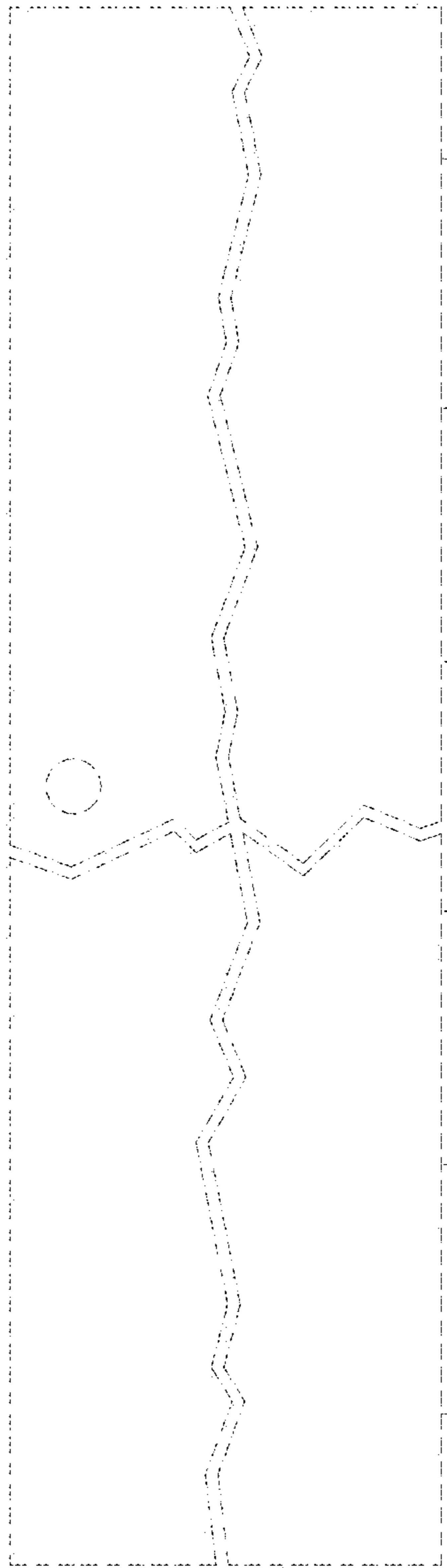

FIG. 4

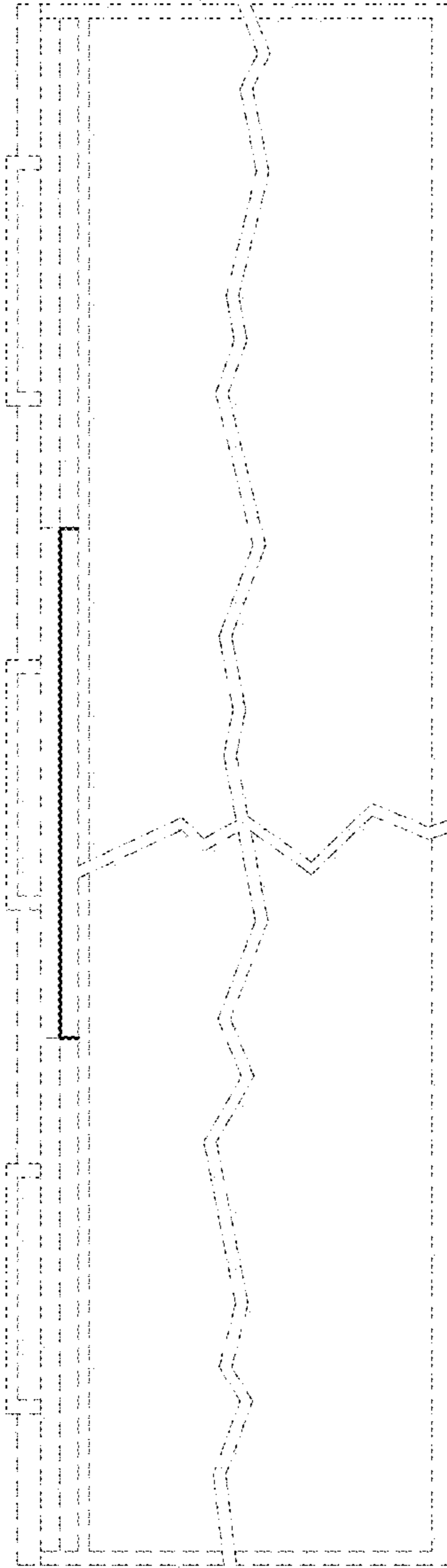

FIG. 5

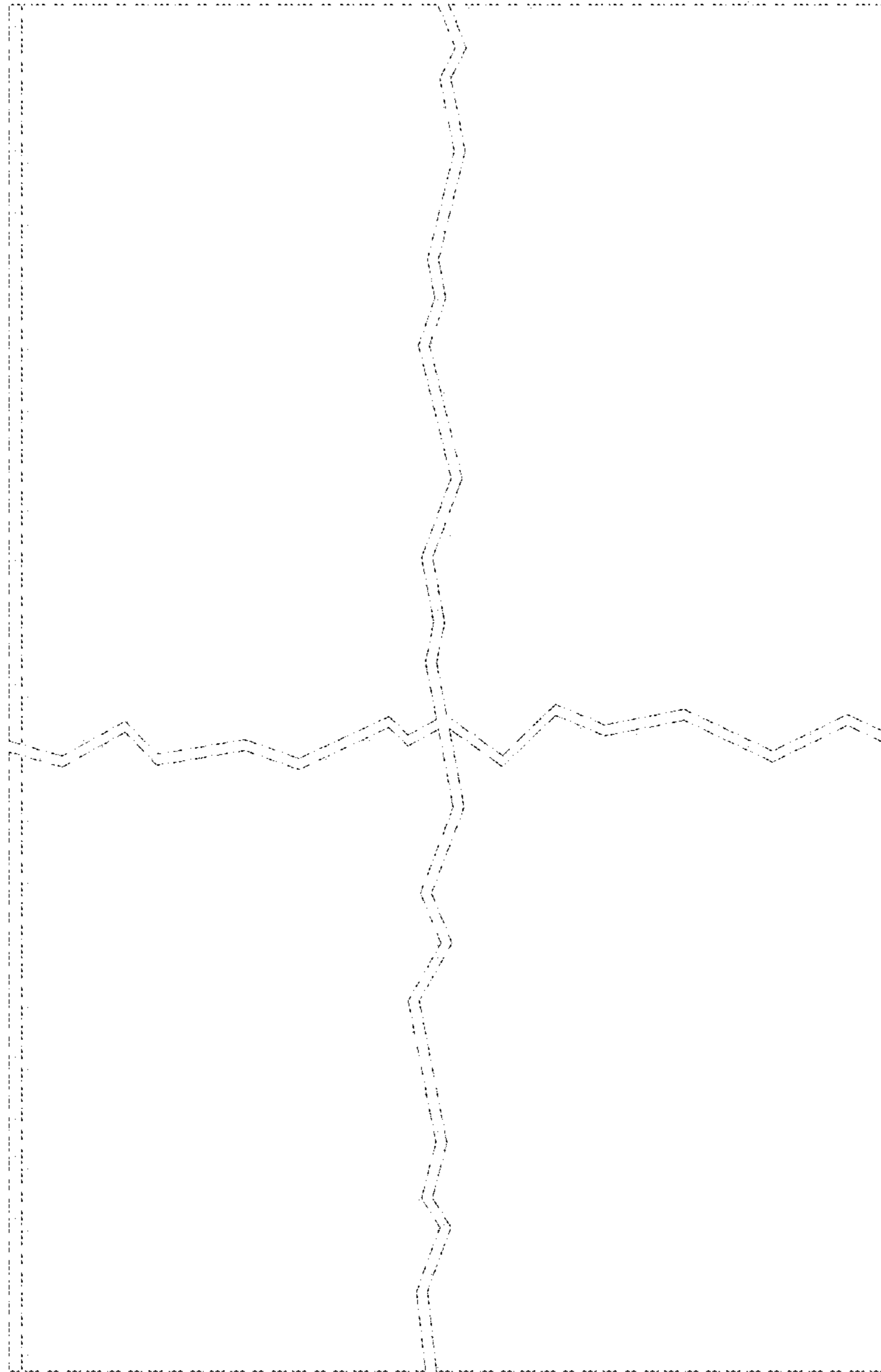

FIG. 6



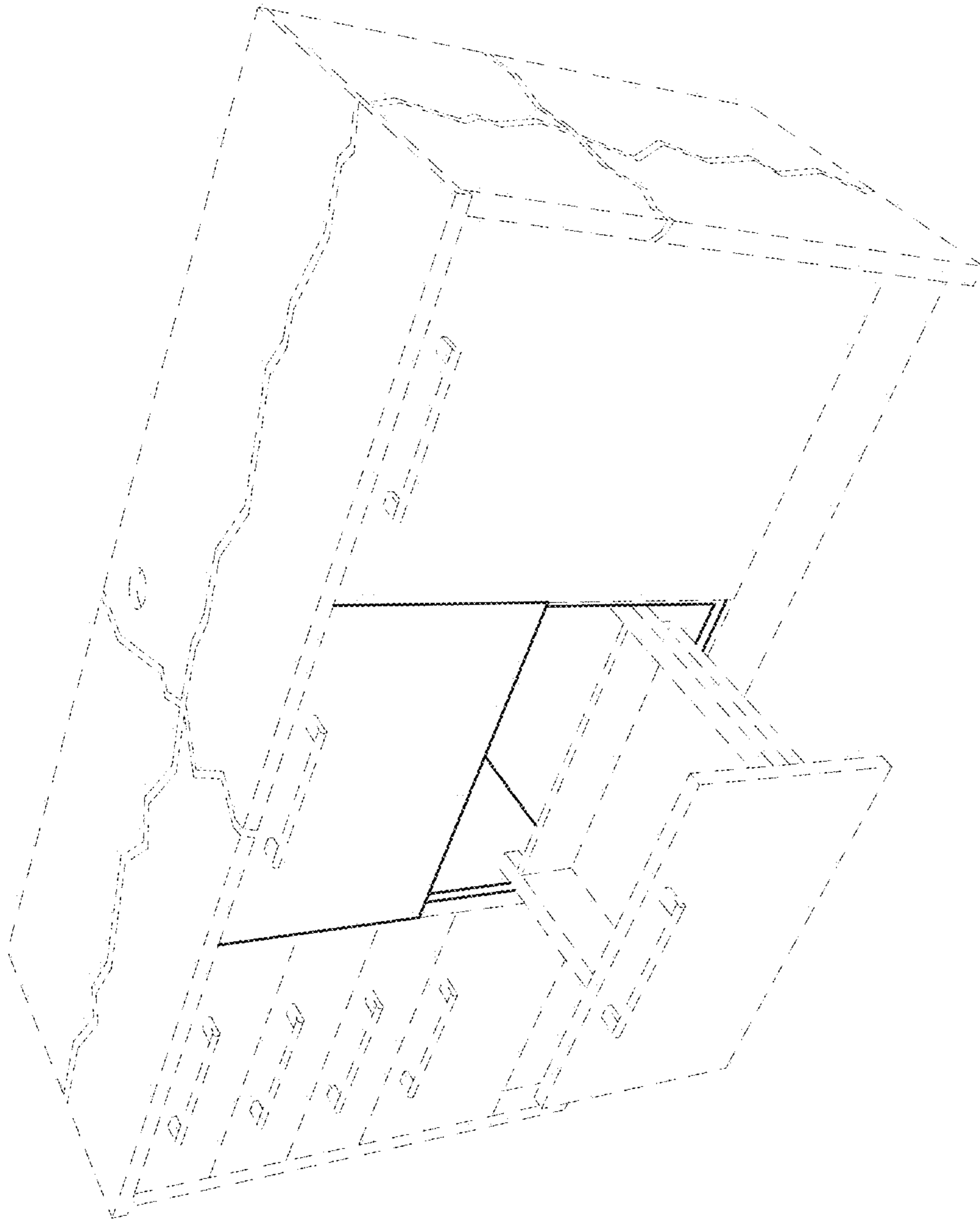

FIG. 7

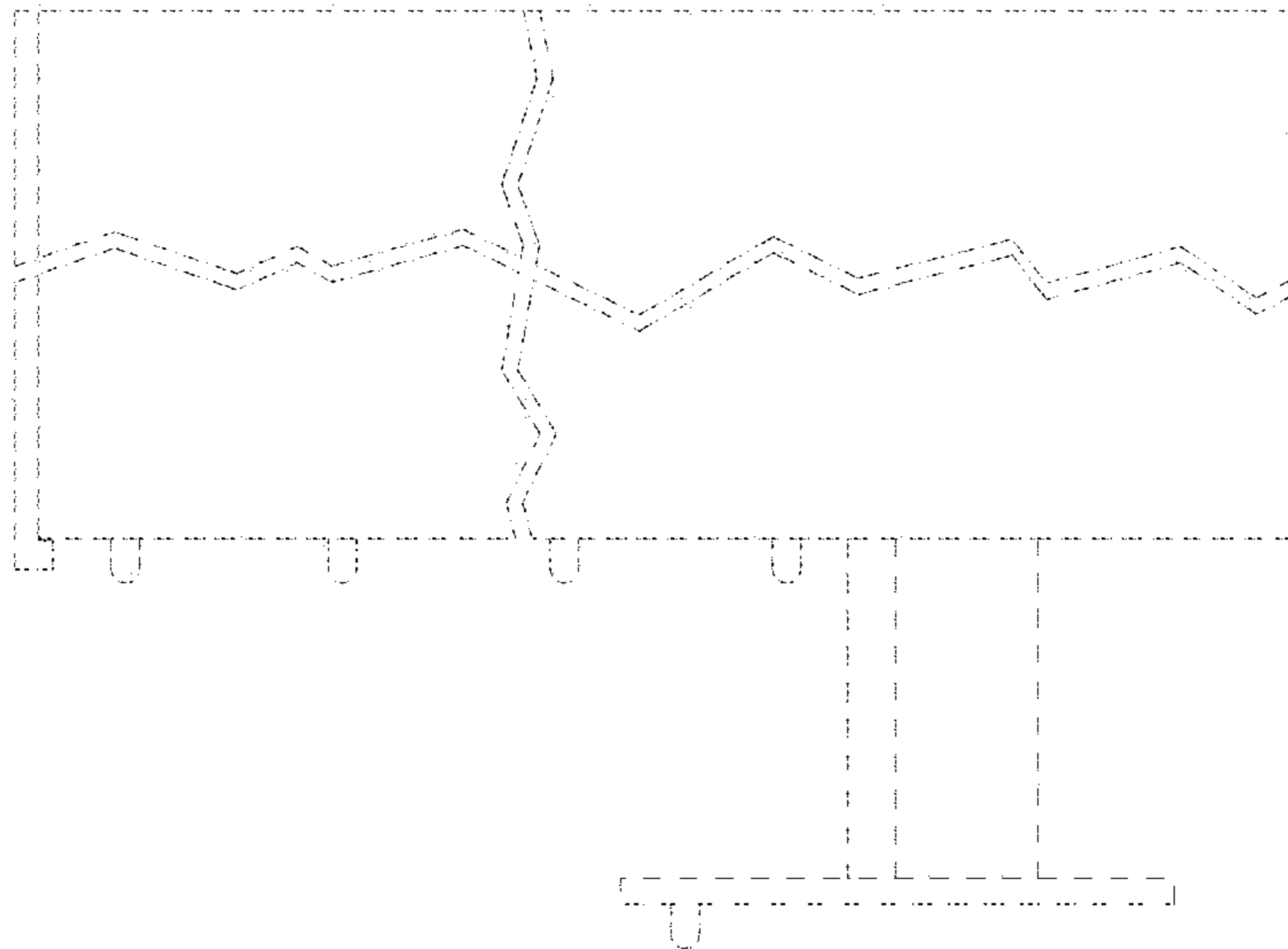

FIG. 8

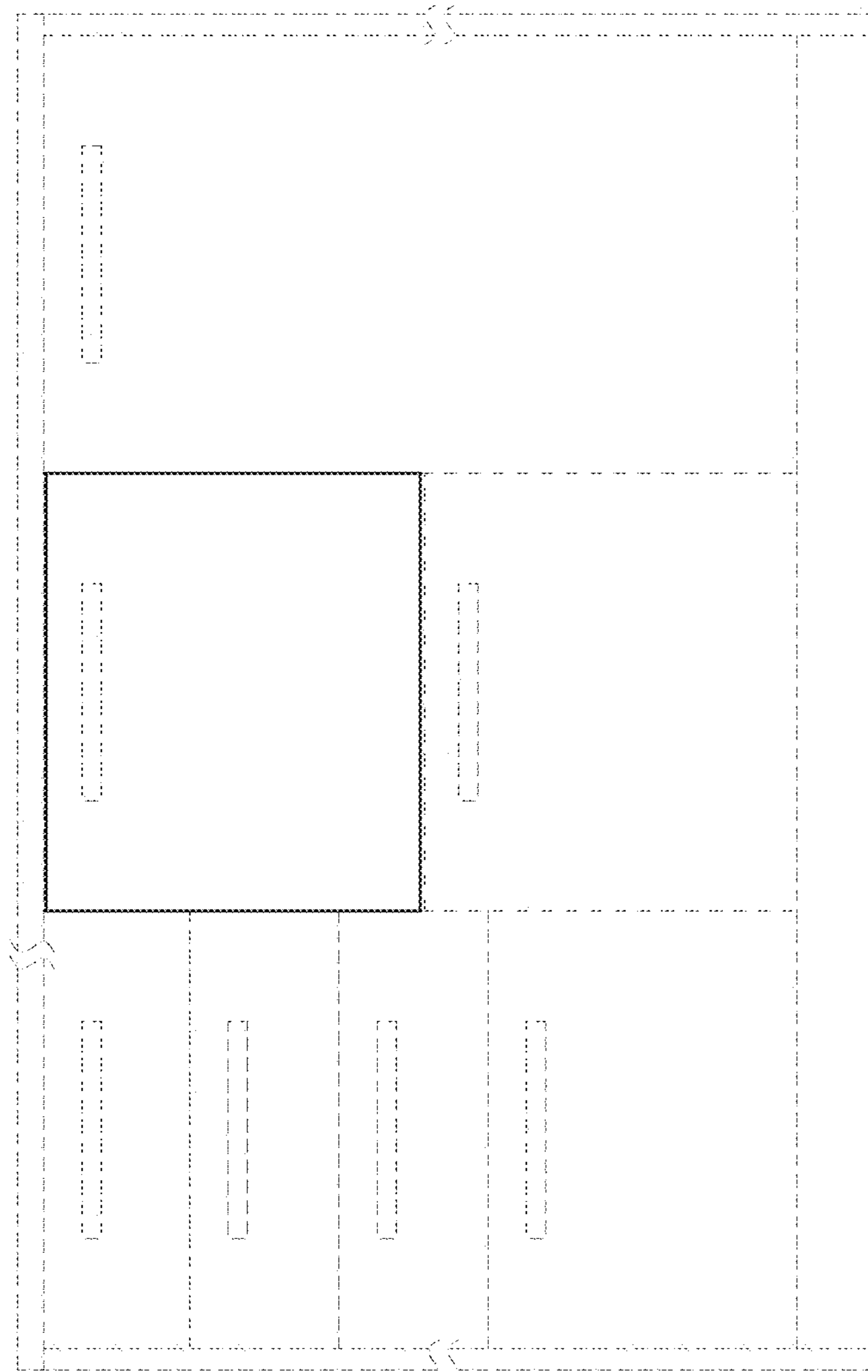

FIG. 9

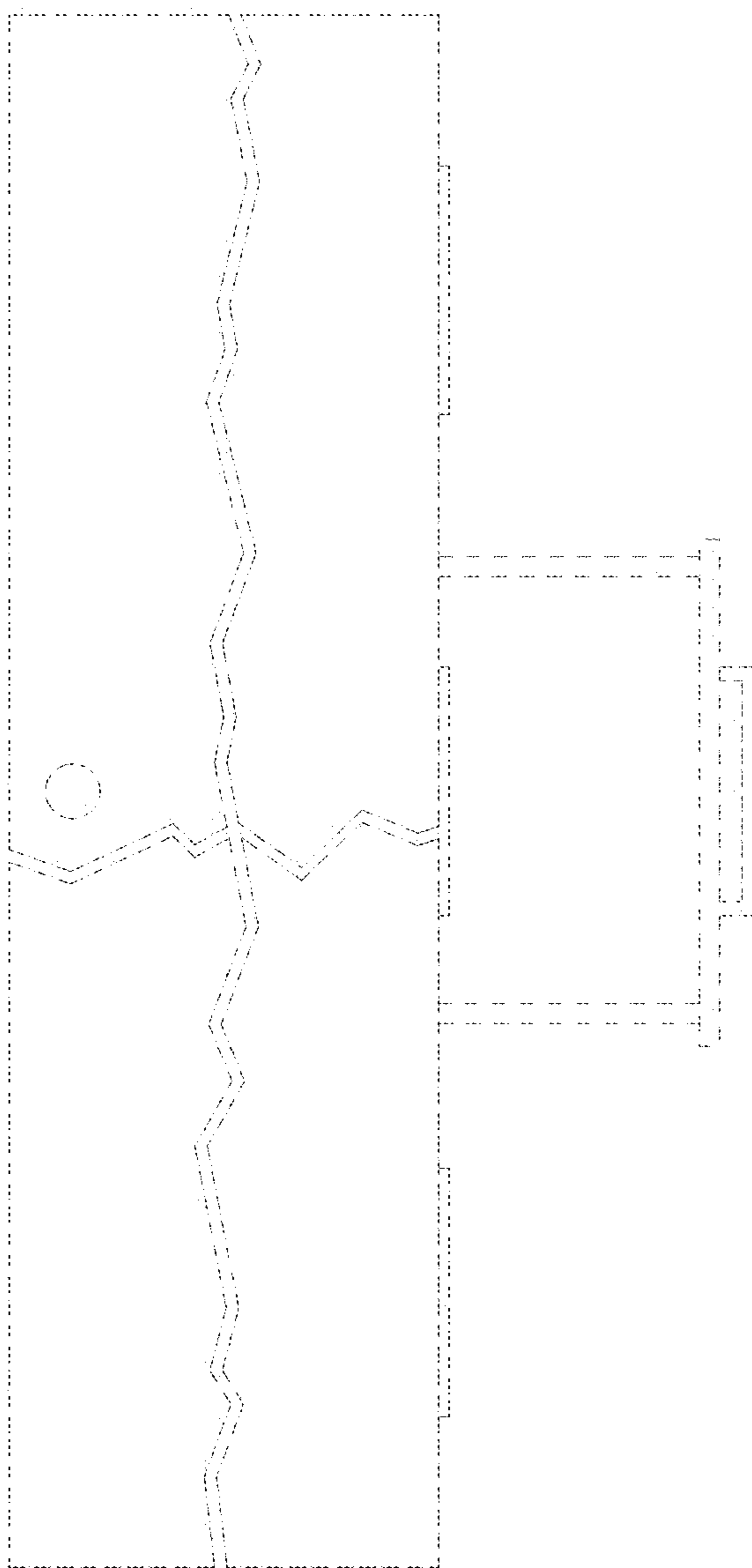

FIG. 10

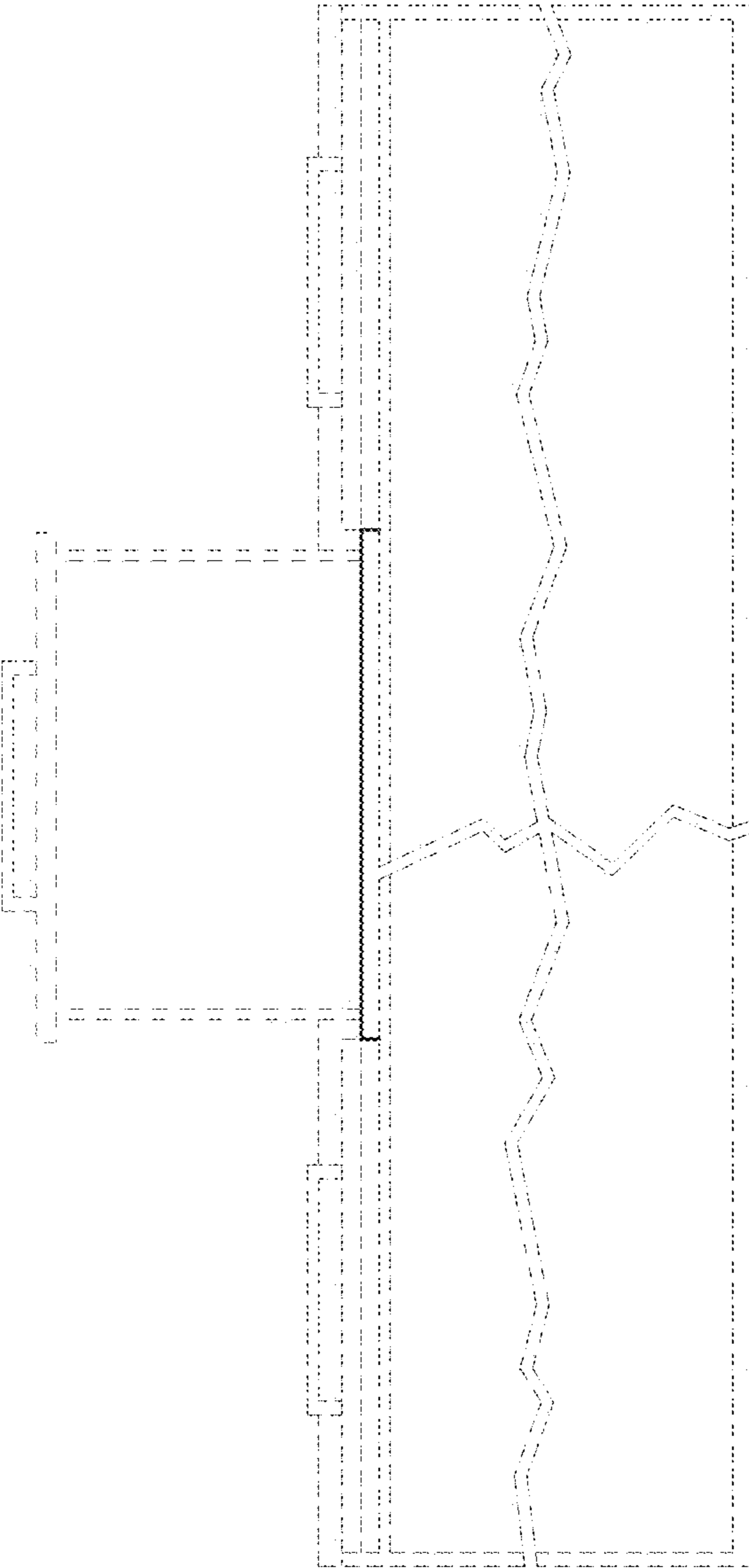

FIG. 11

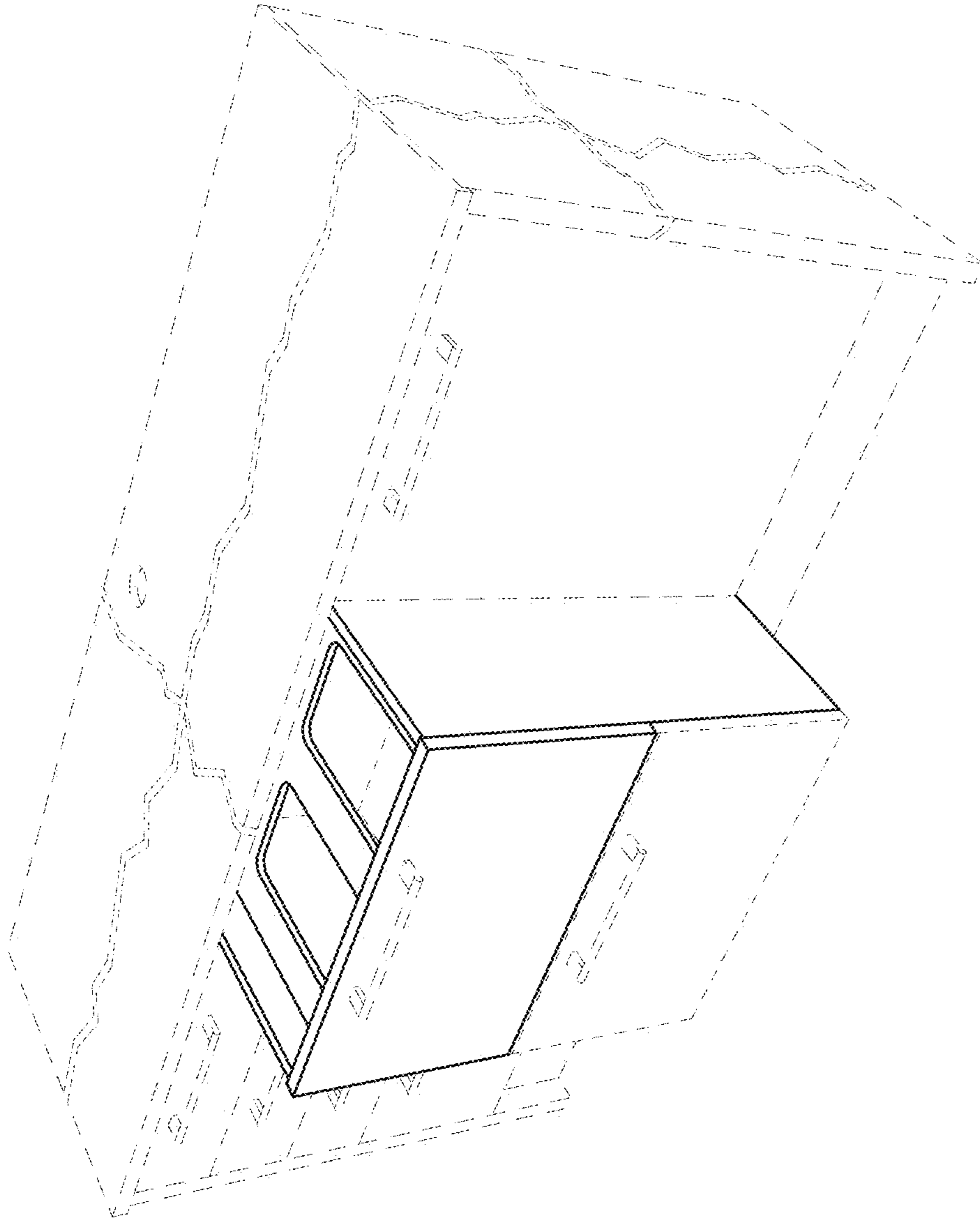

FIG. 12

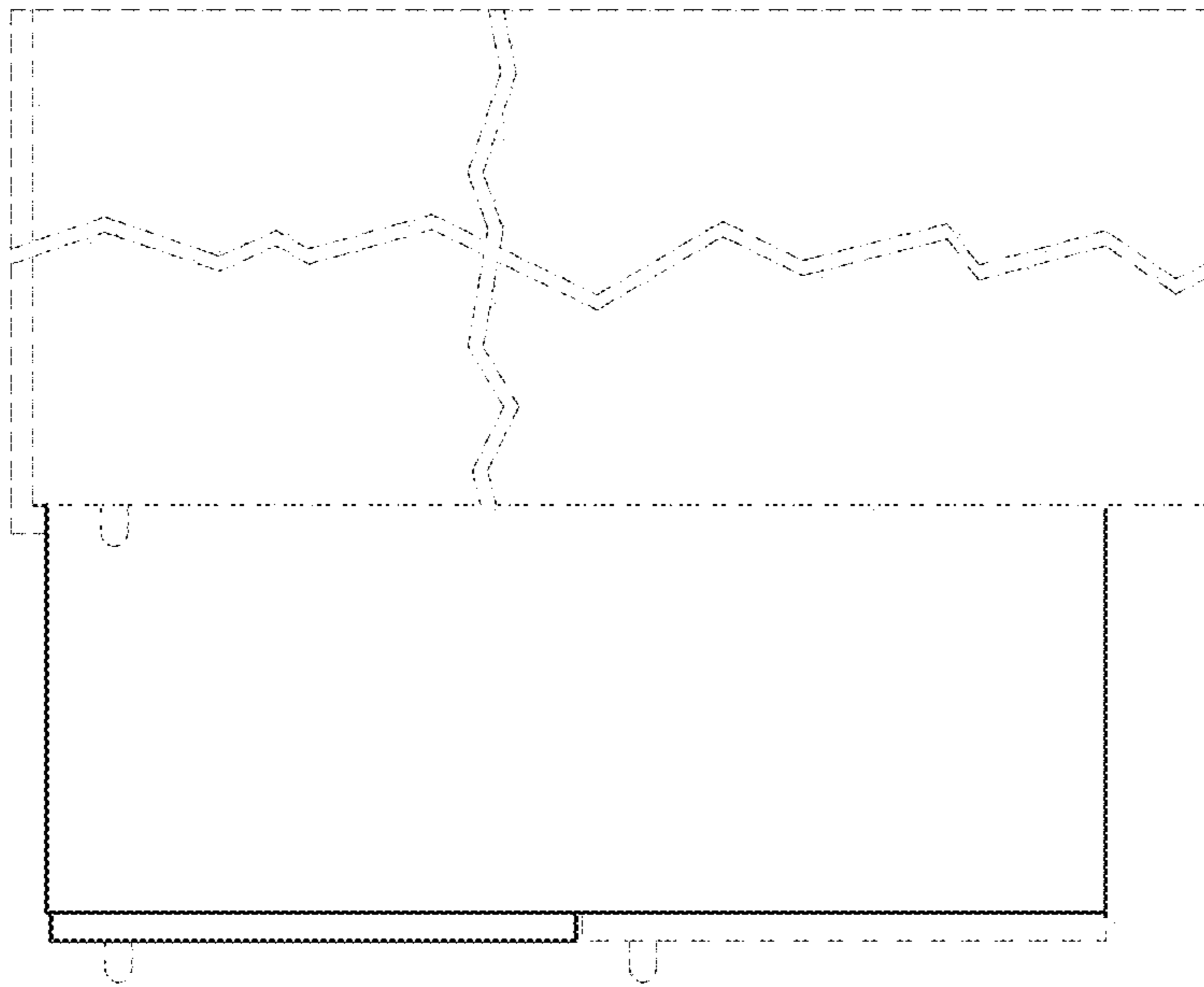

FIG. 13

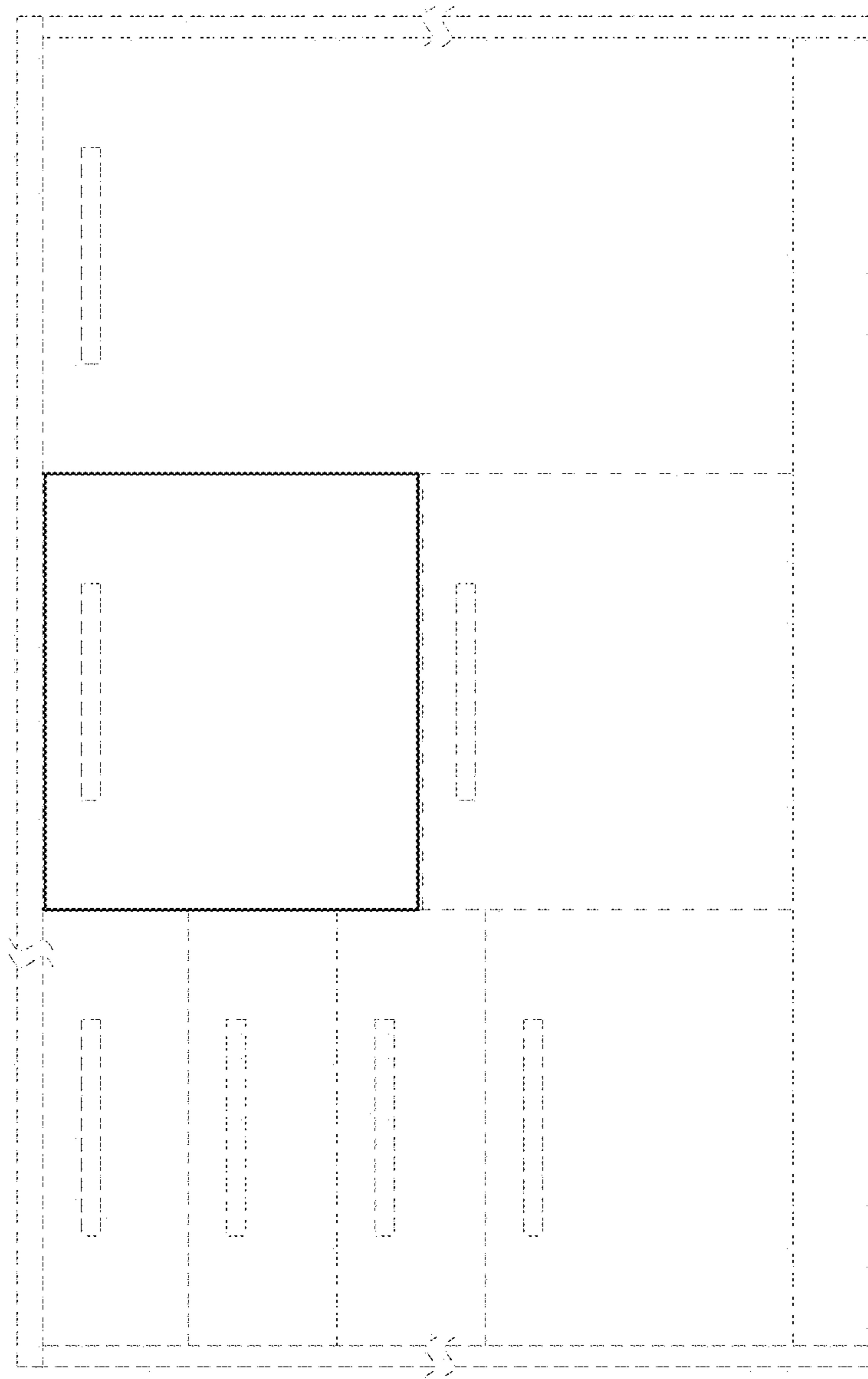

FIG. 14



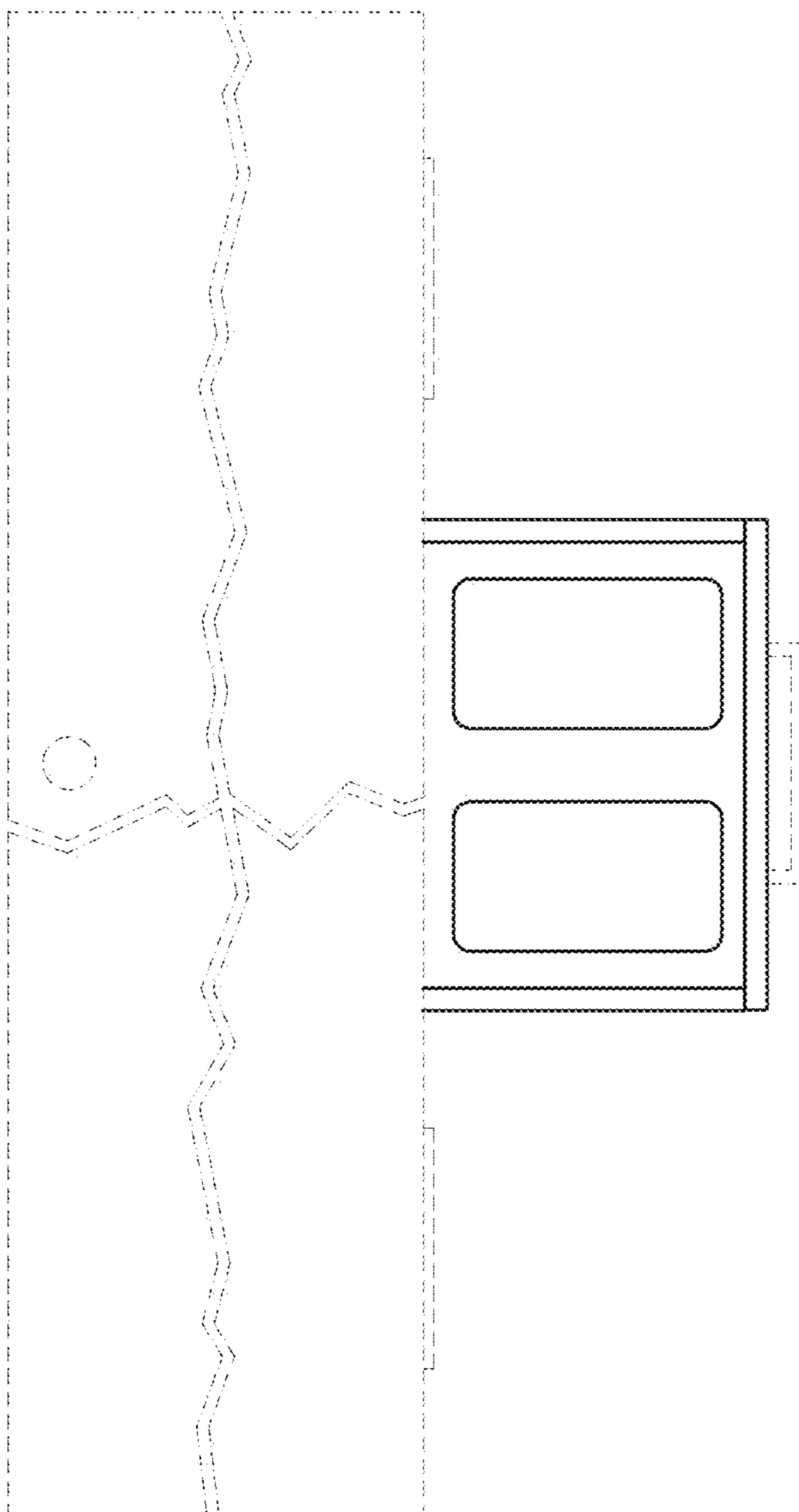

FIG. 15

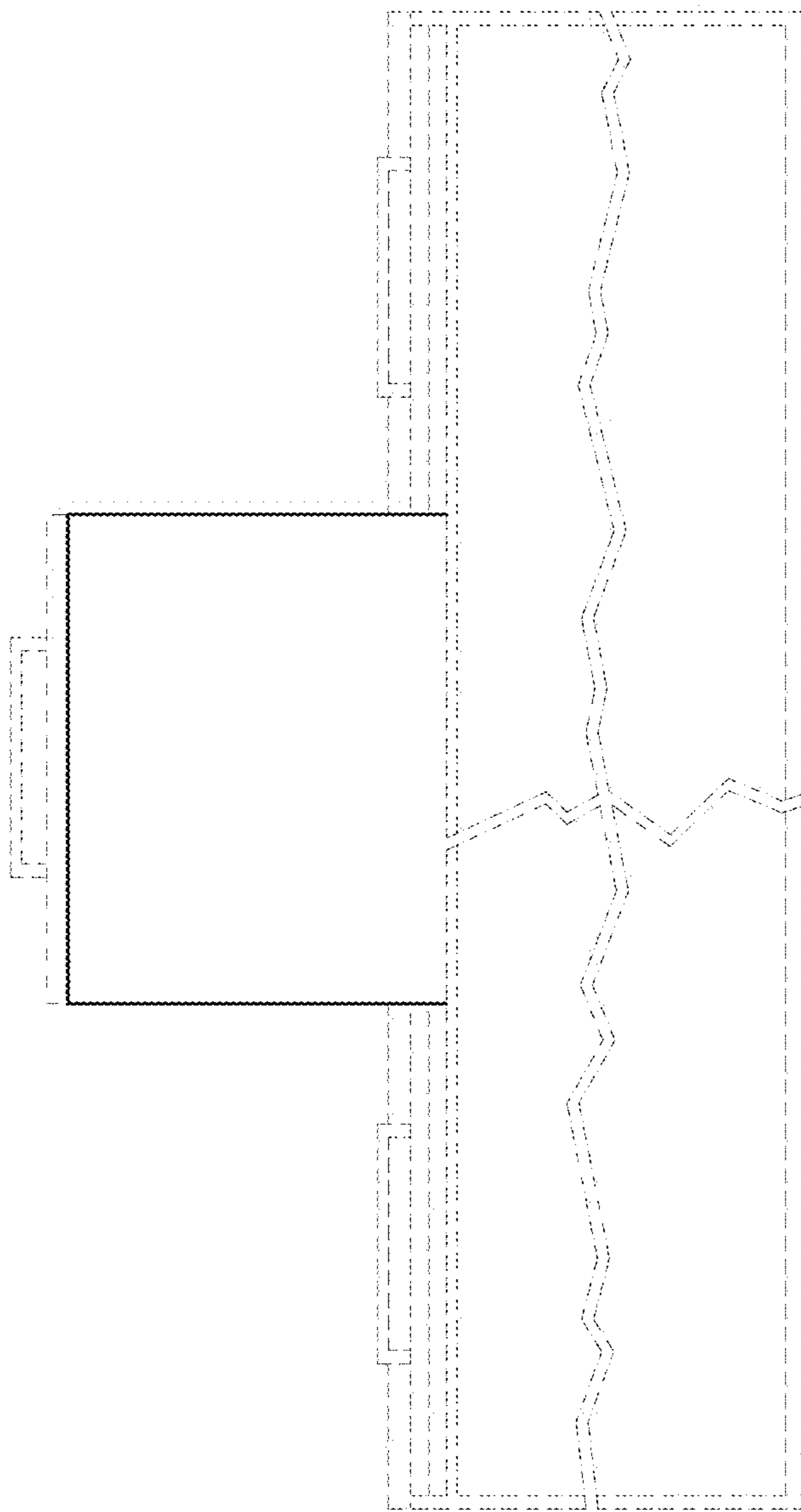

FIG. 16

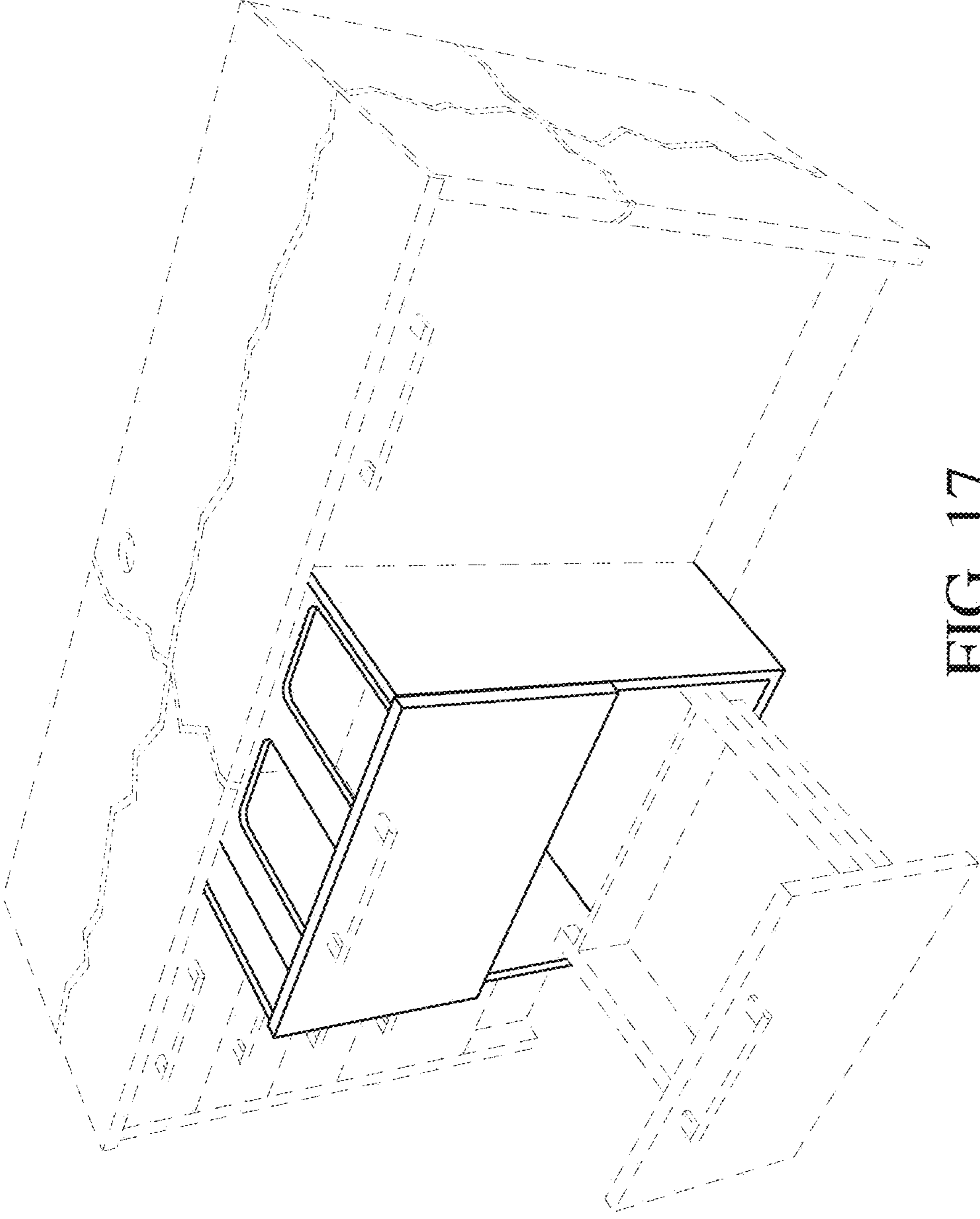

FIG. 17

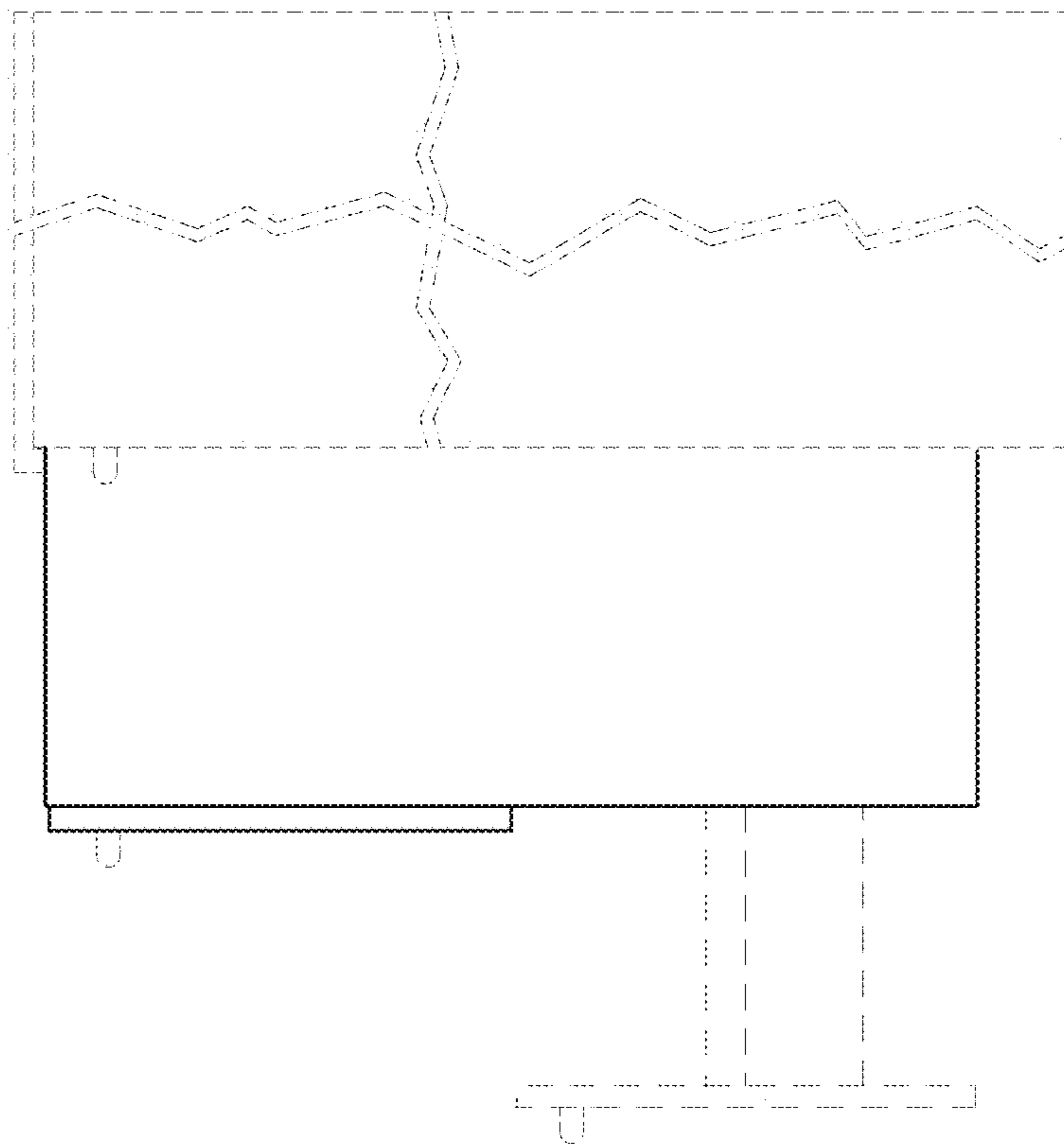

FIG. 18

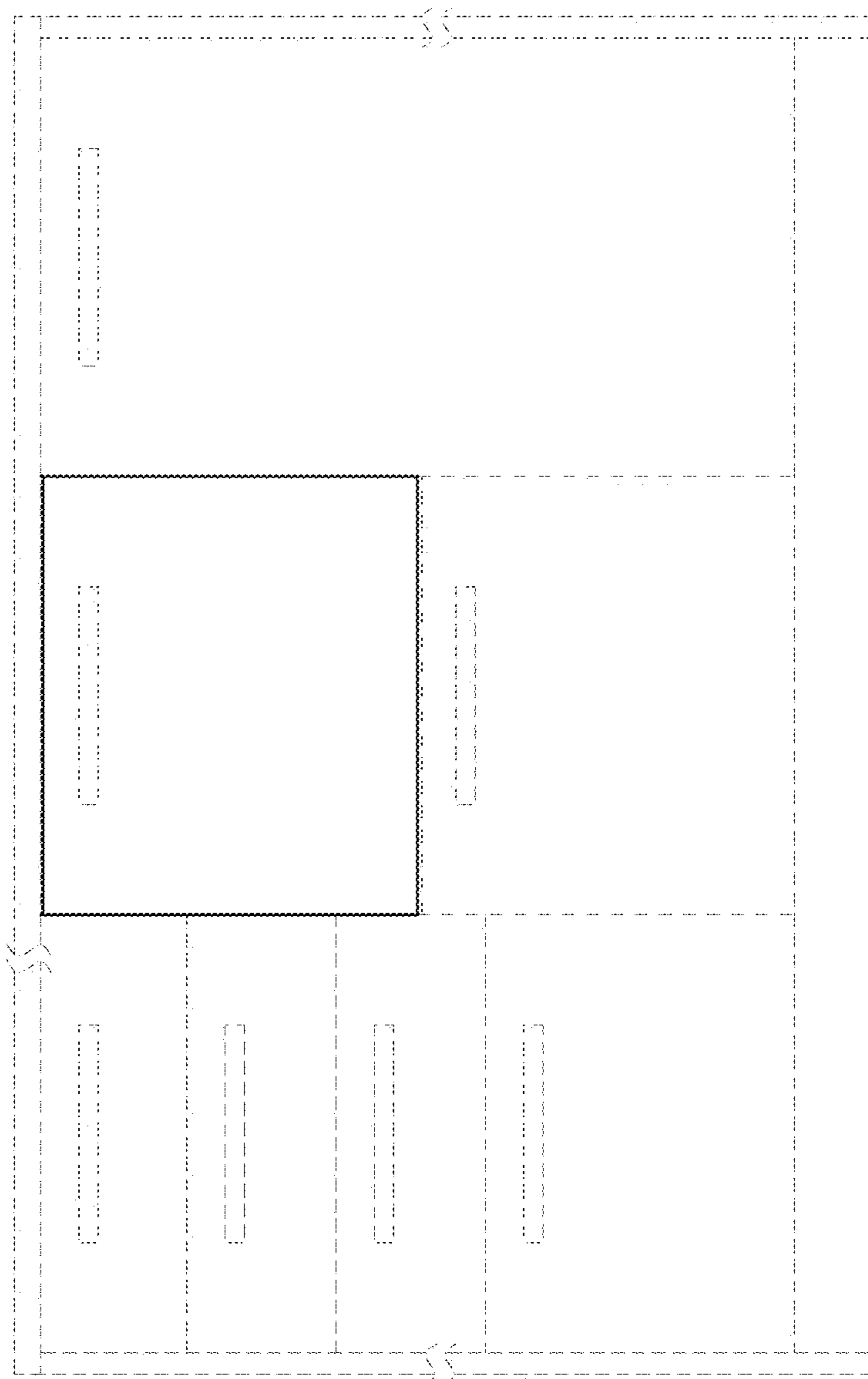

FIG. 19

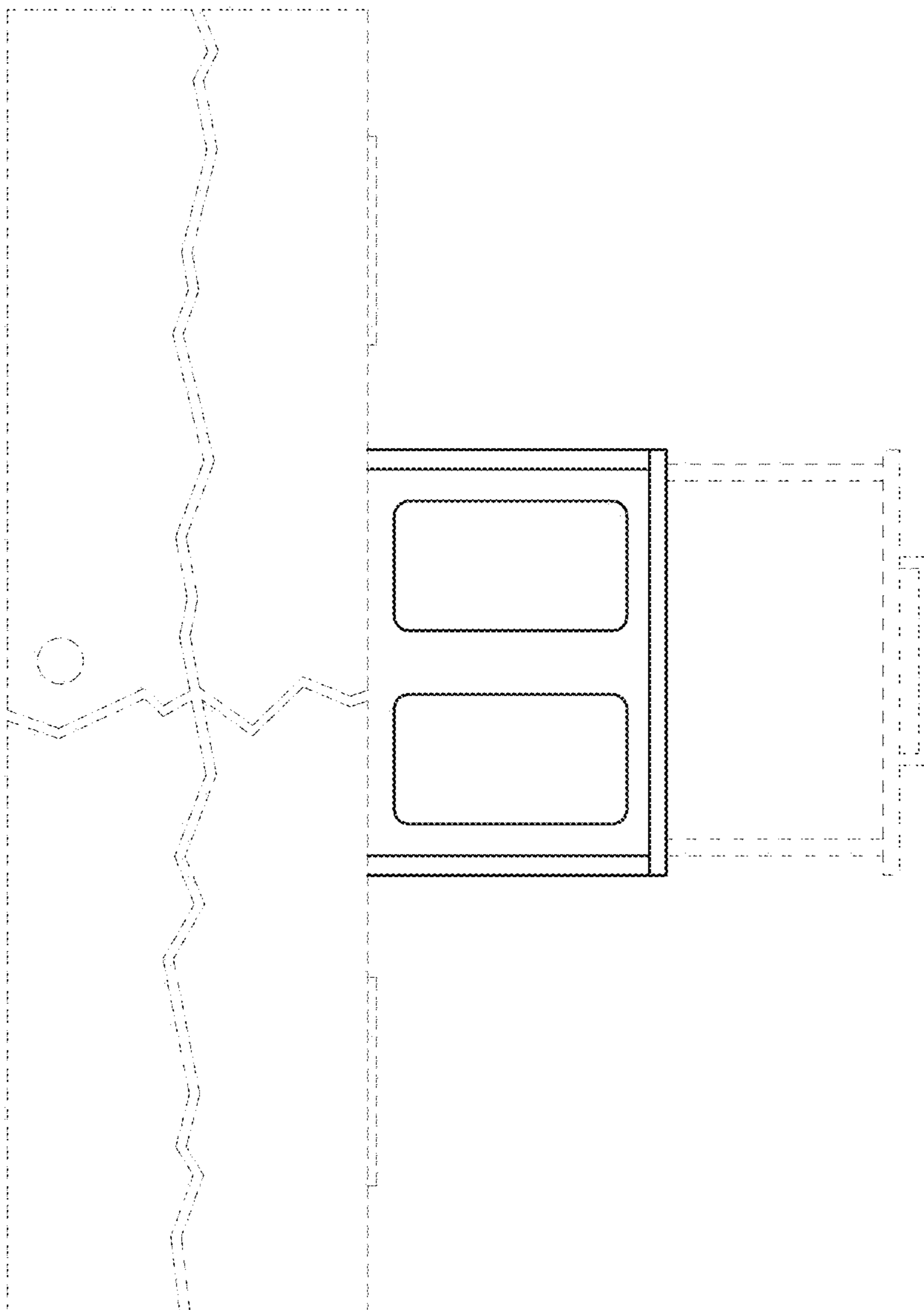

FIG. 20

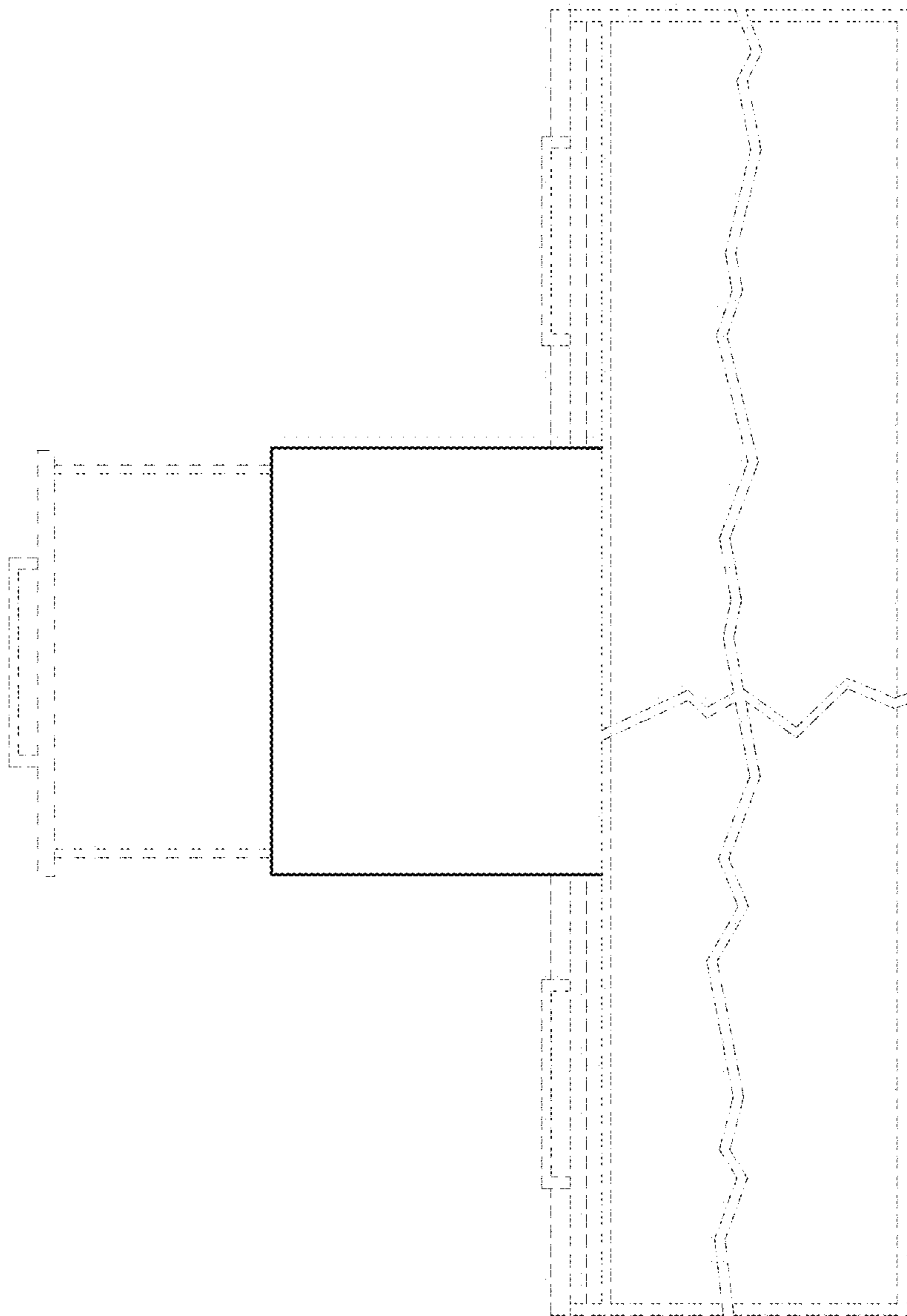

FIG. 21