



US00D749731S

(12) **United States Design Patent**  
**Wegener**

(10) **Patent No.:** **US D749,731 S**

(45) **Date of Patent:** **\*\* Feb. 16, 2016**

(54) **SPLIT BIOPSY NEEDLE**

(71) Applicant: **Paul T. Wegener**, San Diego, CA (US)

(72) Inventor: **Paul T. Wegener**, San Diego, CA (US)

(73) Assignee: **EPITOME PHARMACEUTICALS LIMITED**, San Diego, CA (US)

(\*\*) Term: **14 Years**

(21) Appl. No.: **29/504,944**

(22) Filed: **Oct. 10, 2014**

(51) **LOC (10) Cl.** ..... **24-02**

(52) **U.S. Cl.**  
USPC ..... **D24/146**

(58) **Field of Classification Search**

USPC ..... D7/649; D8/93, 97, 300, 310, 311, 313;  
D19/110, 115; D24/127, 130, 133,  
D24/146, 147, 148

CPC ..... B26B 3/00; B26B 1/10; B26B 5/005;  
A61B 17/809; A61B 17/1617; A61B 17/3211;  
A61B 5/1411; A61B 17/3417

See application file for complete search history.

(56) **References Cited**

**U.S. PATENT DOCUMENTS**

D332,492	S	*	1/1993	Rosenberg et al.	.....	D24/146
5,817,061	A	*	10/1998	Goodwin et al.	.....	604/164.03
D443,360	S	*	6/2001	Haberland	.....	D24/146
D517,694	S	*	3/2006	Wilshire et al.	.....	D24/146
D594,119	S	*	6/2009	Berberich et al.	.....	D24/133
D606,193	S	*	12/2009	Oberlaender et al.	.....	D24/146
D726,907	S	*	4/2015	Trump	.....	D24/130
D728,099	S	*	4/2015	Schad et al.	.....	D24/146
2002/0013597	A1	*	1/2002	McFarlane	.....	606/185
2005/0154409	A1	*	7/2005	MacKool	.....	606/167
2008/0243162	A1	*	10/2008	Shibata et al.	.....	606/185
2012/0253376	A1	*	10/2012	Liu et al.	.....	606/185
2014/0277052	A1	*	9/2014	Haselby et al.	.....	606/185

\* cited by examiner

*Primary Examiner* — Robert M Spear

*Assistant Examiner* — Marissa J Cash

(74) *Attorney, Agent, or Firm* — Fish & Tsang, LLP

(57) **CLAIM**

I claim the ornamental design for a split biopsy needle, as shown and described.

**DESCRIPTION**

FIG. 1—Top, front, right side perspective view of a split biopsy needle shown in a retracted position of use;

FIG. 2—Front elevation view of FIG. 1, shown at an enlarged scale.

FIG. 3—Rear elevation view of FIG. 1, shown at an enlarged scale.

FIG. 4—Top plan view of FIG. 1, the bottom plan view being identical.

FIG. 5—Right side elevation view of FIG. 1, the left side elevation view being a mirror image.

FIG. 6—Cross-sectional view, taken along line 6-6 of FIG. 4.

FIG. 7—Top, front, right side perspective view of a split biopsy needle shown in an alternate extended position of use;

FIG. 8—Top, front, right side perspective view of the stylus, shown removed from the split biopsy needle for clarity of disclosure.

FIG. 9—Front elevation view of FIG. 8, shown at an enlarged scale.

FIG. 10—Rear elevation view of FIG. 8, shown at an enlarged scale.

FIG. 11—Top plan view of FIG. 8, the bottom plan view being identical.

FIG. 12 is a right side elevation view of FIG. 8, the left side elevation view being a mirror image.

FIG. 13 is a right side elevation view, the left side elevation view being a mirror image of the first alternate length embodiment.

FIG. 14 is a right side elevation view, the left side elevation view being a mirror image of the second alternate length embodiment.

FIG. 15 is a cross-sectional view, taken along line 15-15 of FIG. 11.

FIG. 16 is a cross-sectional view, taken along line 16-16 of FIG. 12, shown at an enlarged scale.

FIG. 17 is a cross-sectional view, taken along line 17-17 of FIG. 12, shown at an enlarged scale.

FIG. 18 is a cross-sectional view, of an alternate embodiment, shown at an enlarged scale.

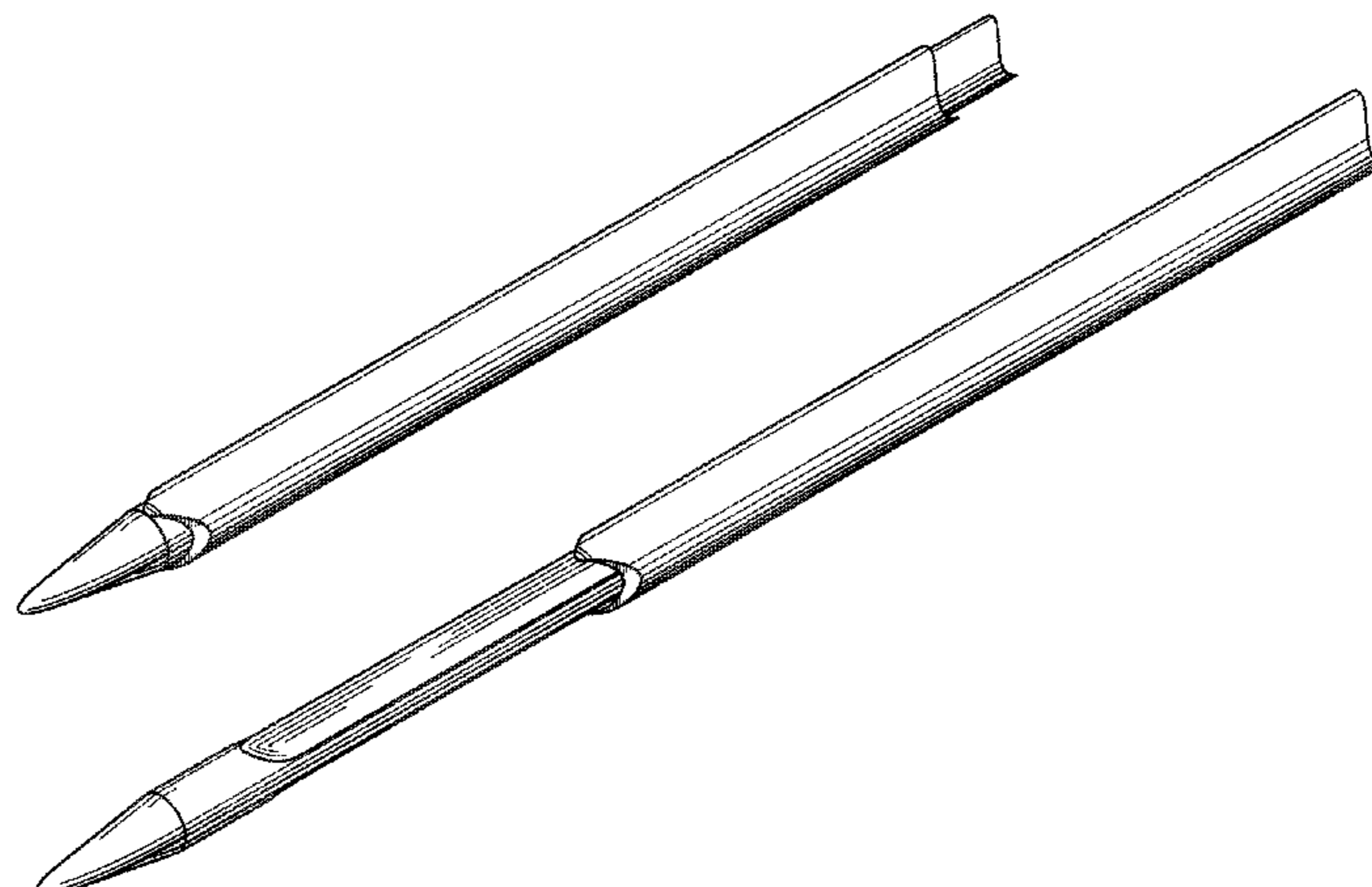

FIG. **19** is a detail cross-sectional view of the circled portion of FIG. **15** shown at an enlarged scale.

FIG. **20** is a detail cross-sectional view of the alternate embodiment shown in FIG. **18**.

FIG. **21** is a top, front, right side perspective view shown removed from the split biopsy needle for clarity of disclosure.

FIG. **22** is a front elevation view of FIG. **21**, shown at an enlarged scale.

FIG. **23** is a rear elevation view of FIG. **21**, shown at an enlarged scale.

FIG. **24** is a top plan view of FIG. **21**, the bottom plan view being identical.

FIG. **25** is a right side elevation view of FIG. **21**, the left side elevation view being a mirror image.

FIG. **26** is a cross-sectional view, taken along line **26-26** of FIG. **24**.

FIG. **27** is a detail cross-sectional view of the circled portion of FIG. **26** shown at an enlarged scale.

FIG. **28** is a top, front, right side perspective view of an alternate embodiment, shown removed from the split biopsy needle for clarity of disclosure.

FIG. **29** is front elevation view of FIG. **28**, shown at an enlarged scale.

FIG. **30** is a rear elevation view of FIG. **28** shown at an enlarged scale.

FIG. **31** is a top plan view of FIG. **28**, the bottom plan view being identical.

FIG. **32** is a right side elevation view of FIG. **28**, the left side elevation view being a mirror image.

FIG. **33** is a cross-sectional view, taken along line **33-33** of FIG. **31**; and,

FIG. **34** is a detail cross sectional view of the circled portion of FIG. **33** shown at an enlarged scale.

**1 Claim, 8 Drawing Sheets**

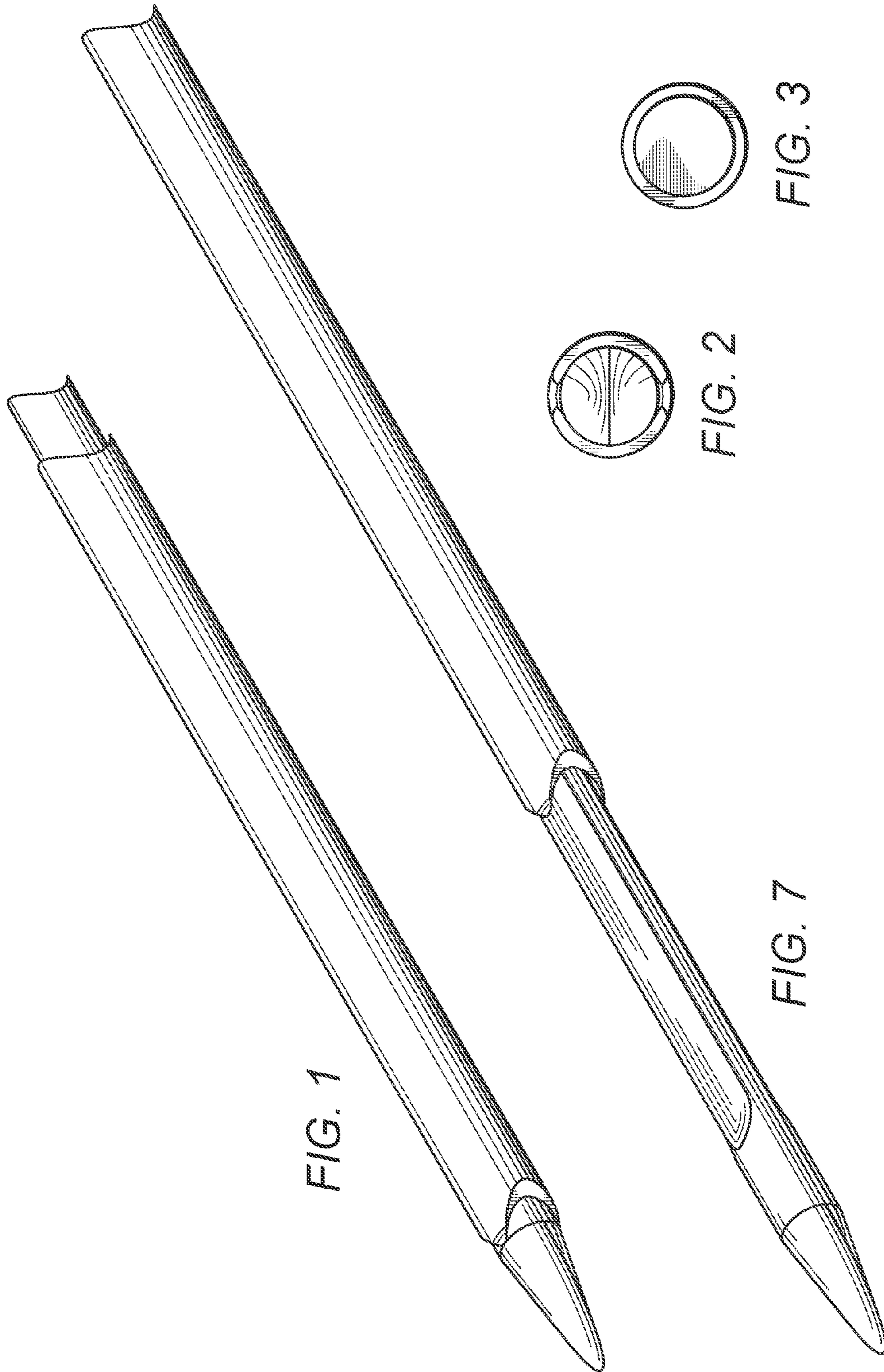

FIG. 1

FIG. 2

FIG. 7

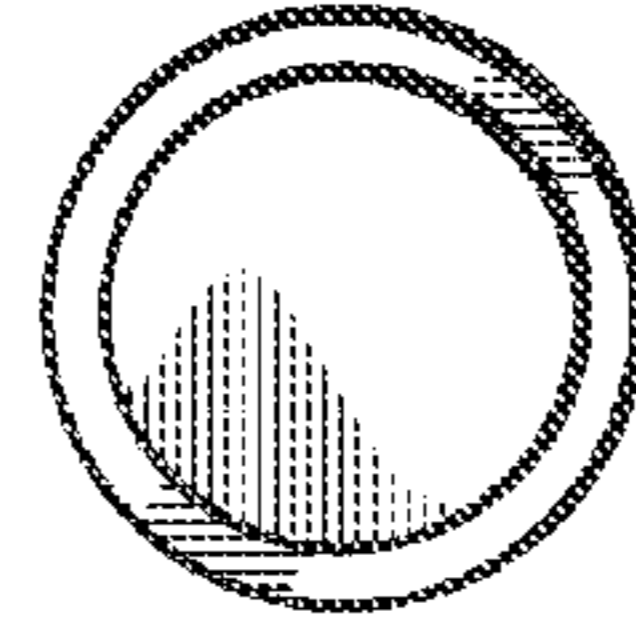

FIG. 3

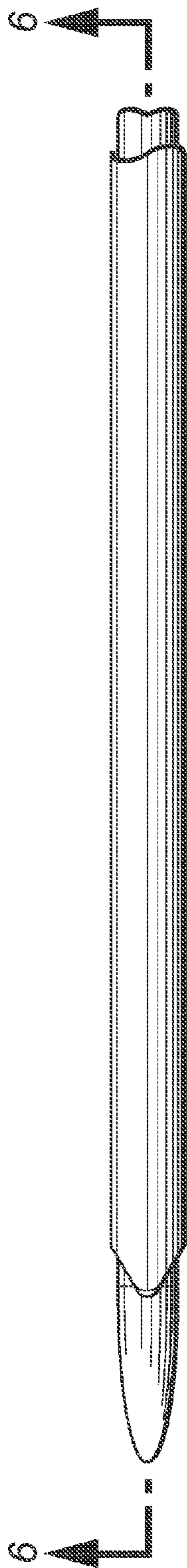

FIG. 4

FIG. 5

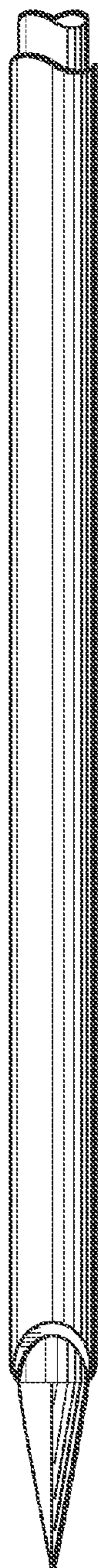
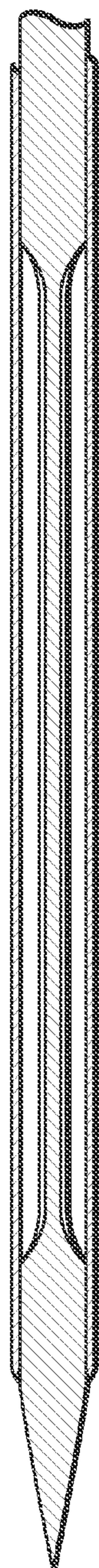

FIG. 6



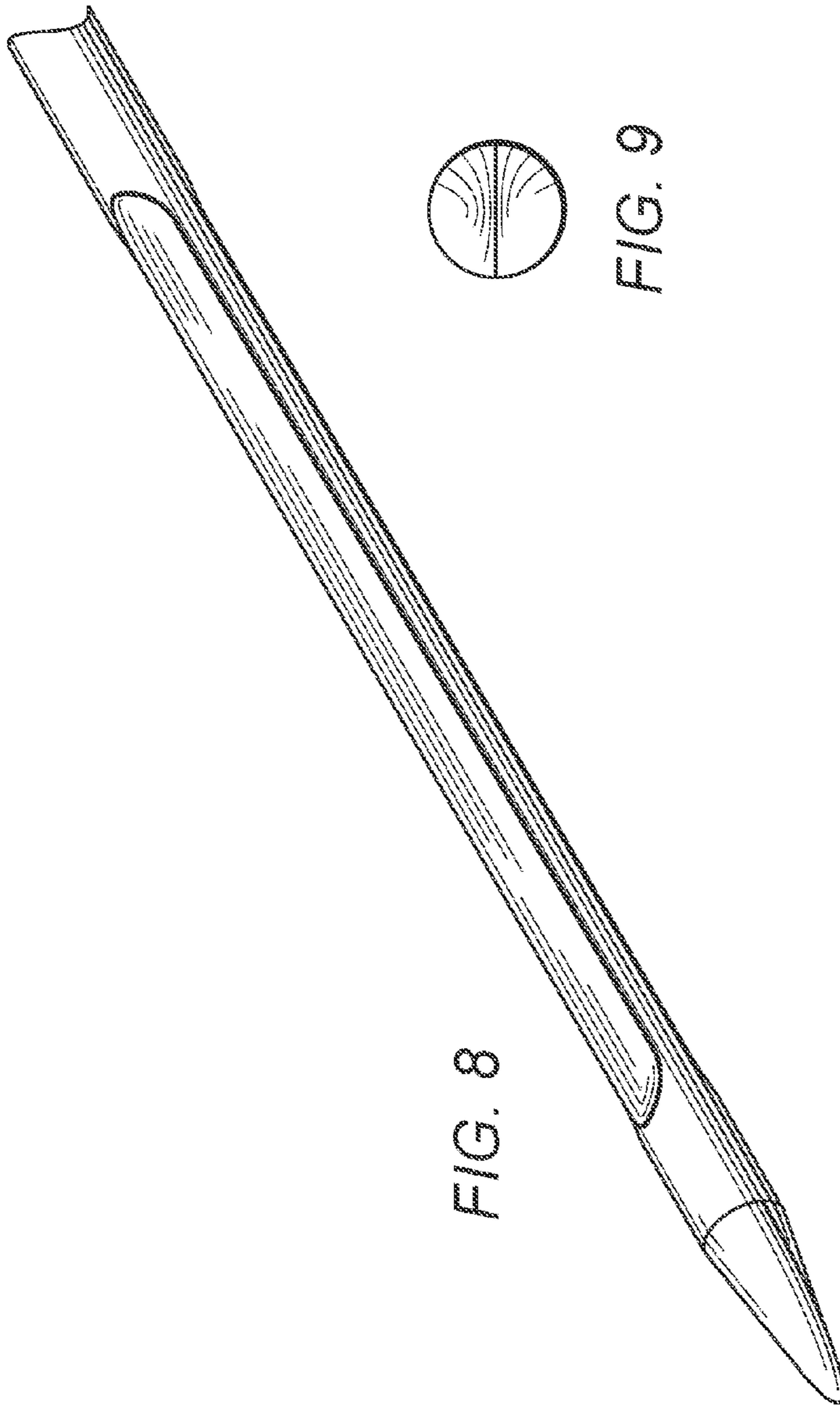

FIG. 8

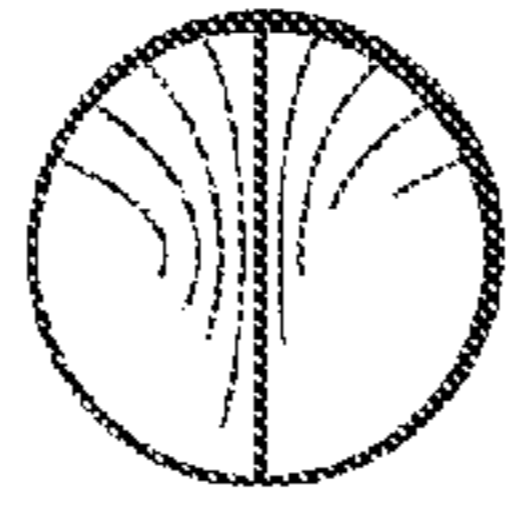

FIG. 9

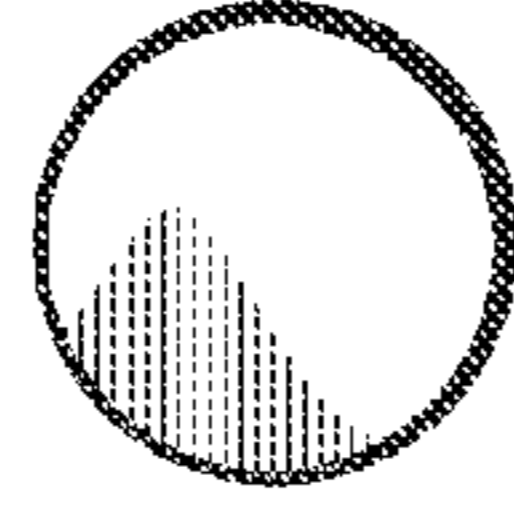

FIG. 10

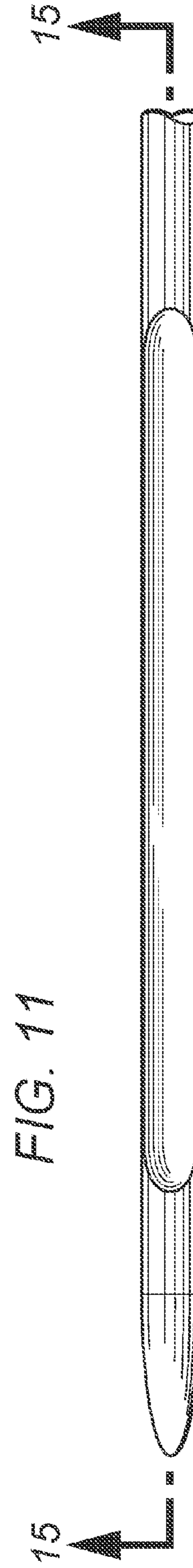

FIG. 11

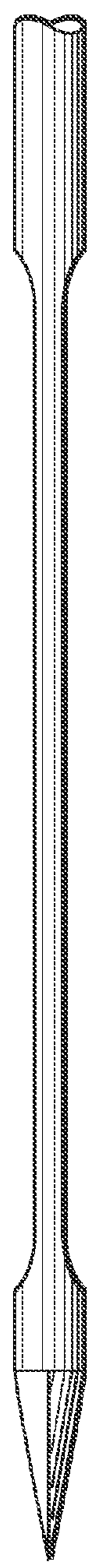
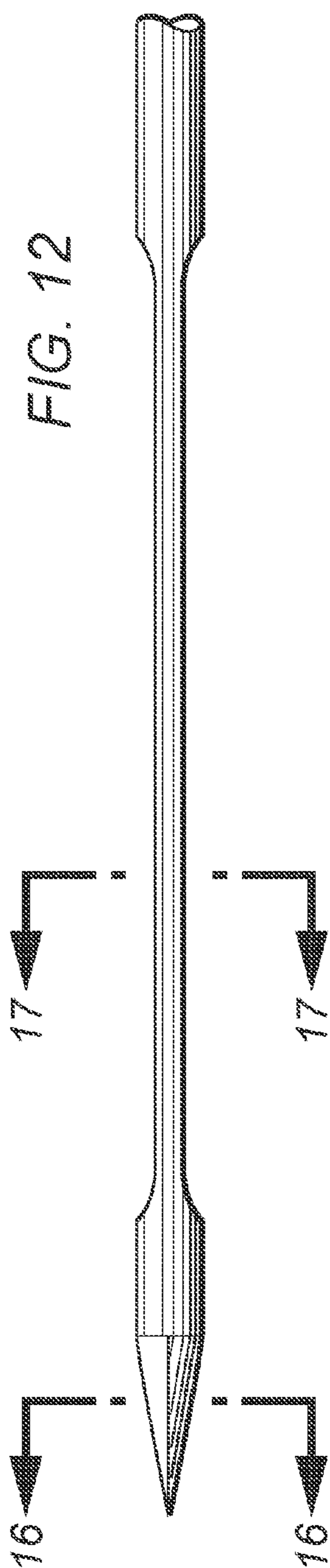

FIG. 13

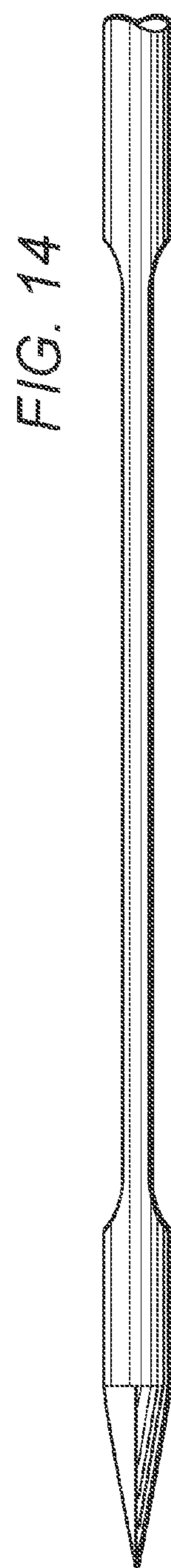
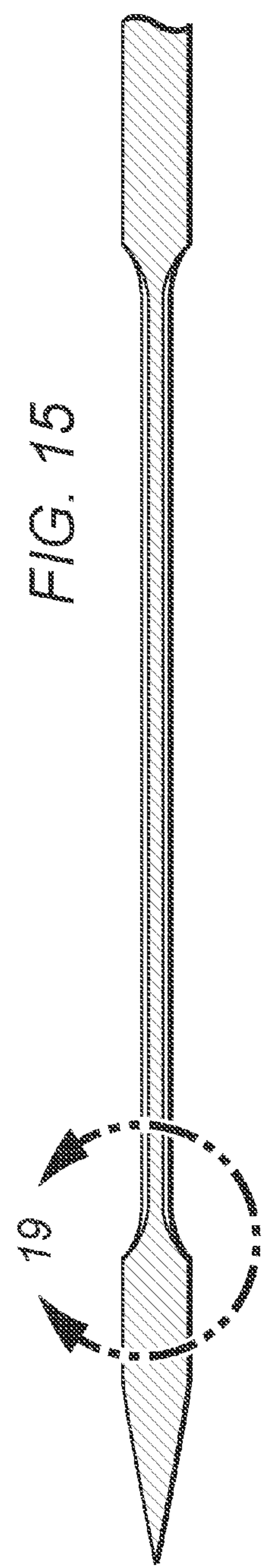

FIG. 14



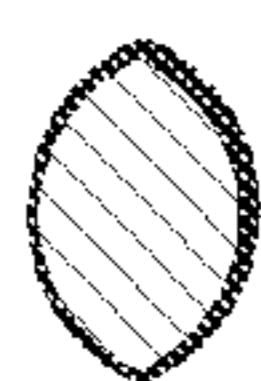

FIG. 16

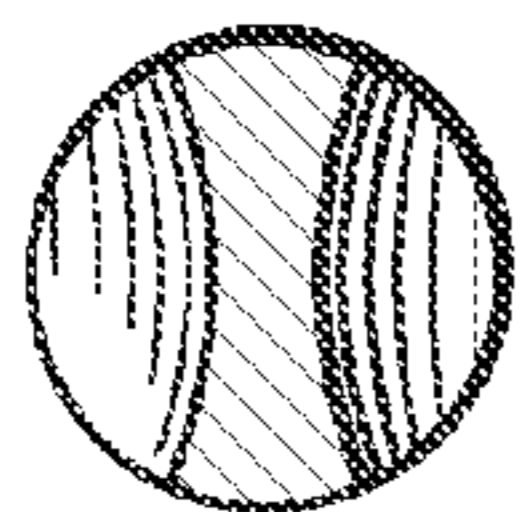

FIG. 17

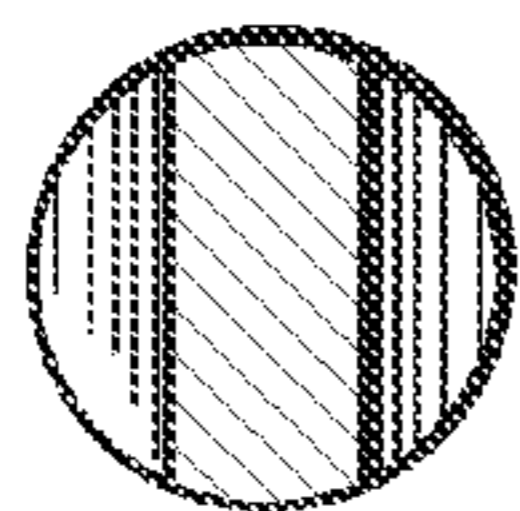

FIG. 18

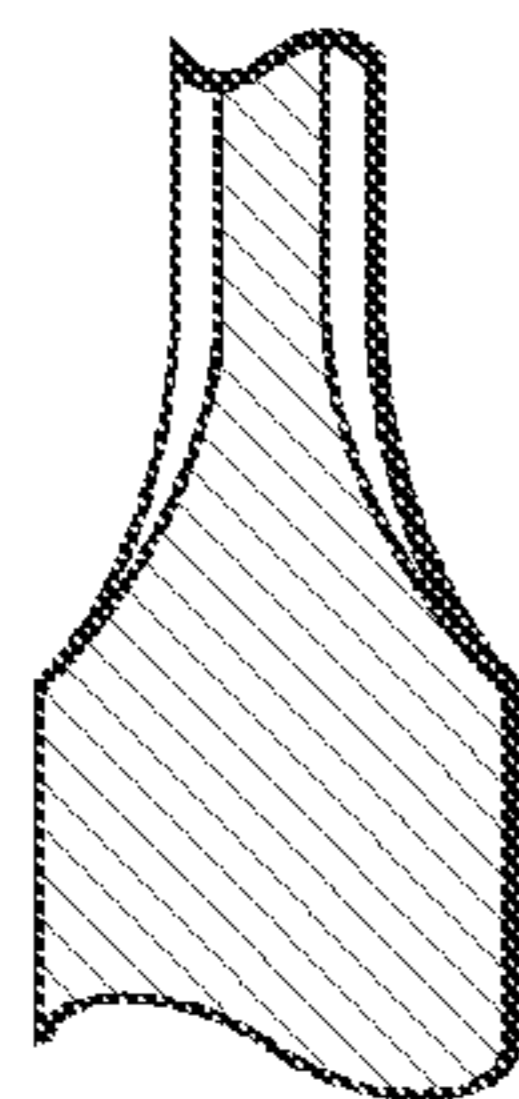

FIG. 19

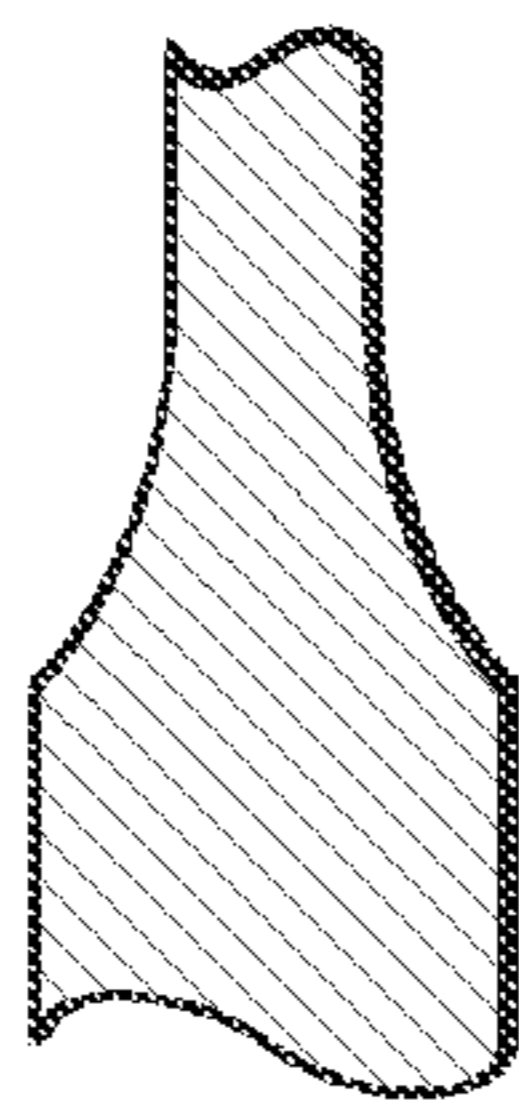

FIG. 20

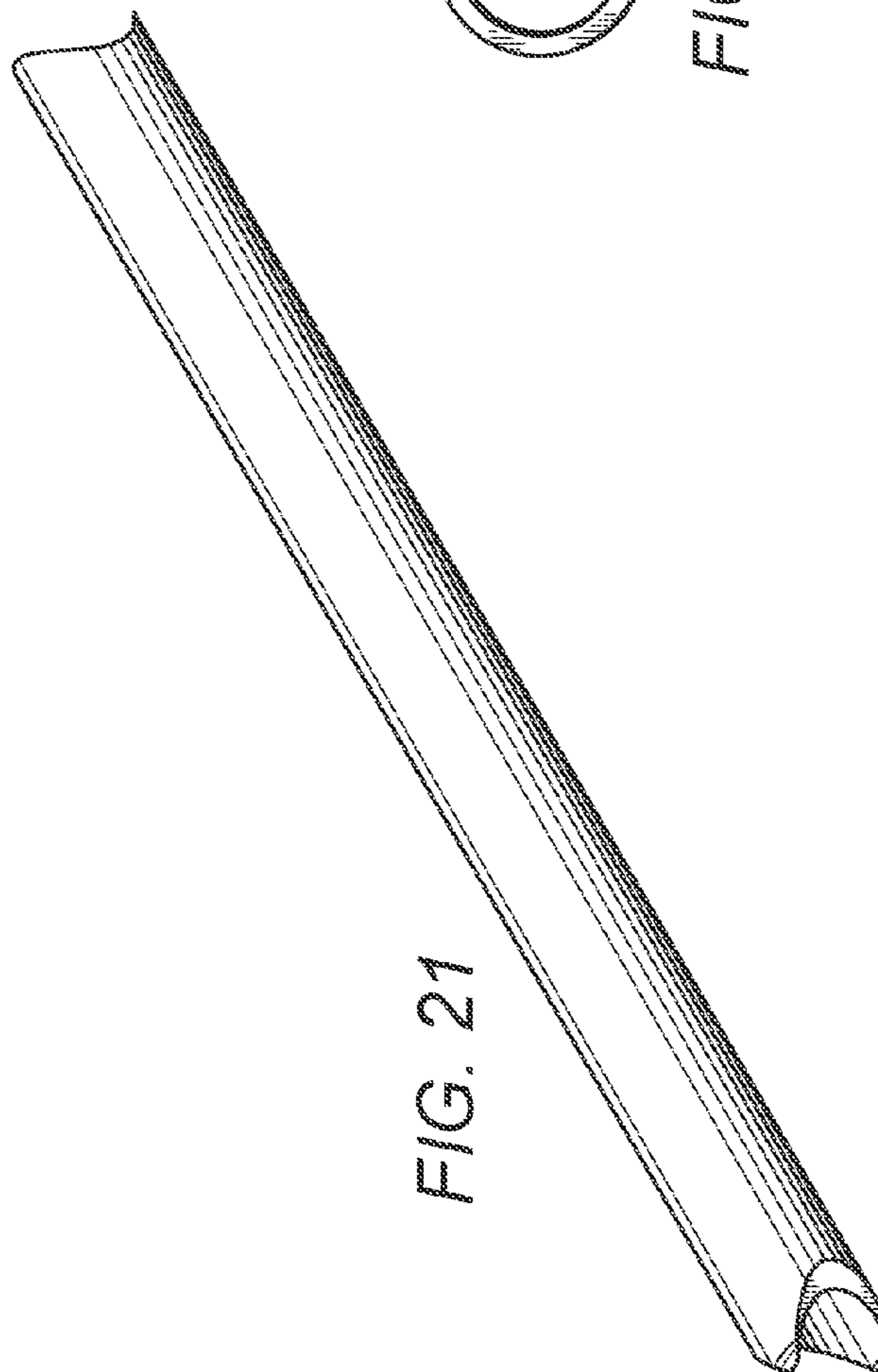

FIG. 21

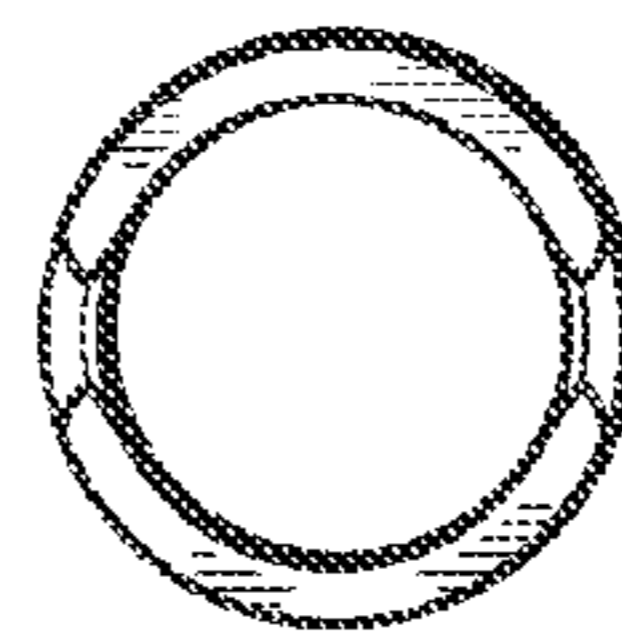

FIG. 22

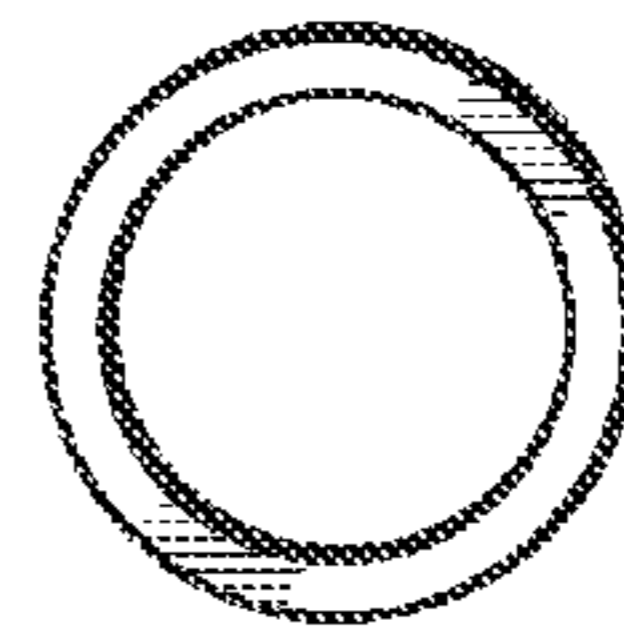

FIG. 23

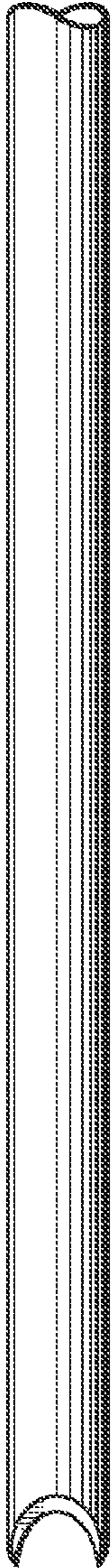
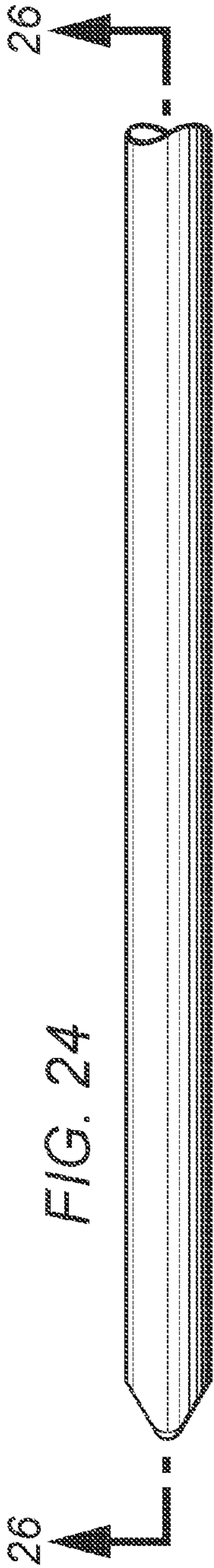

FIG. 25

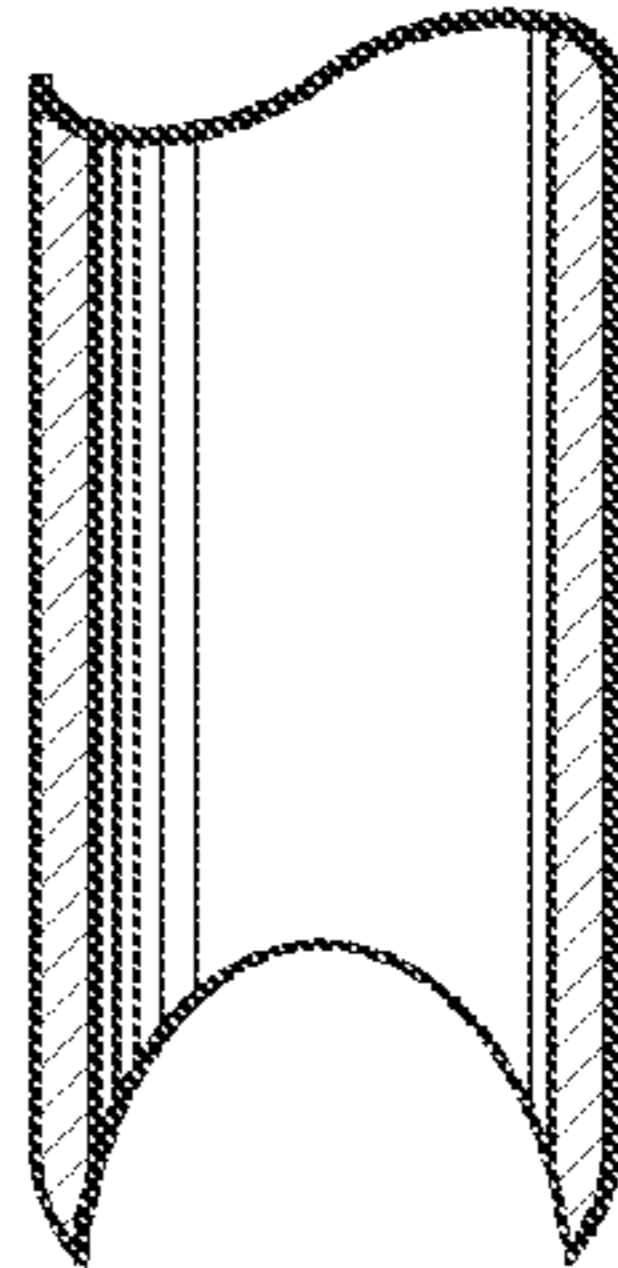
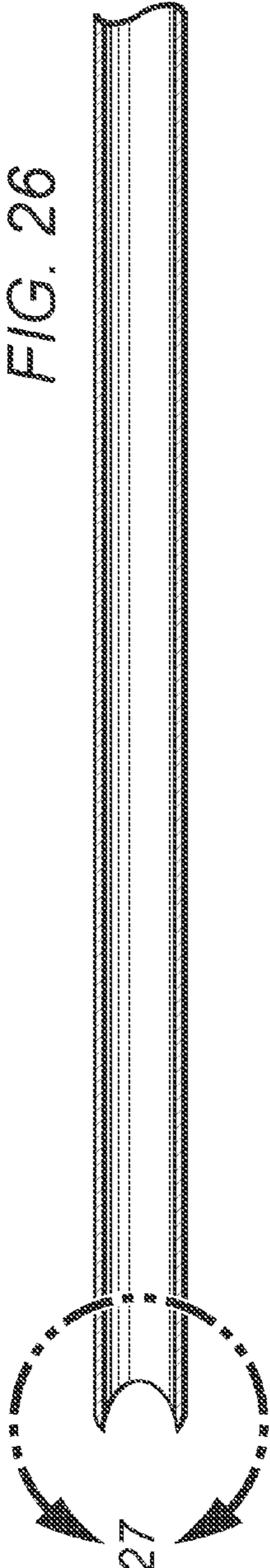

FIG. 27



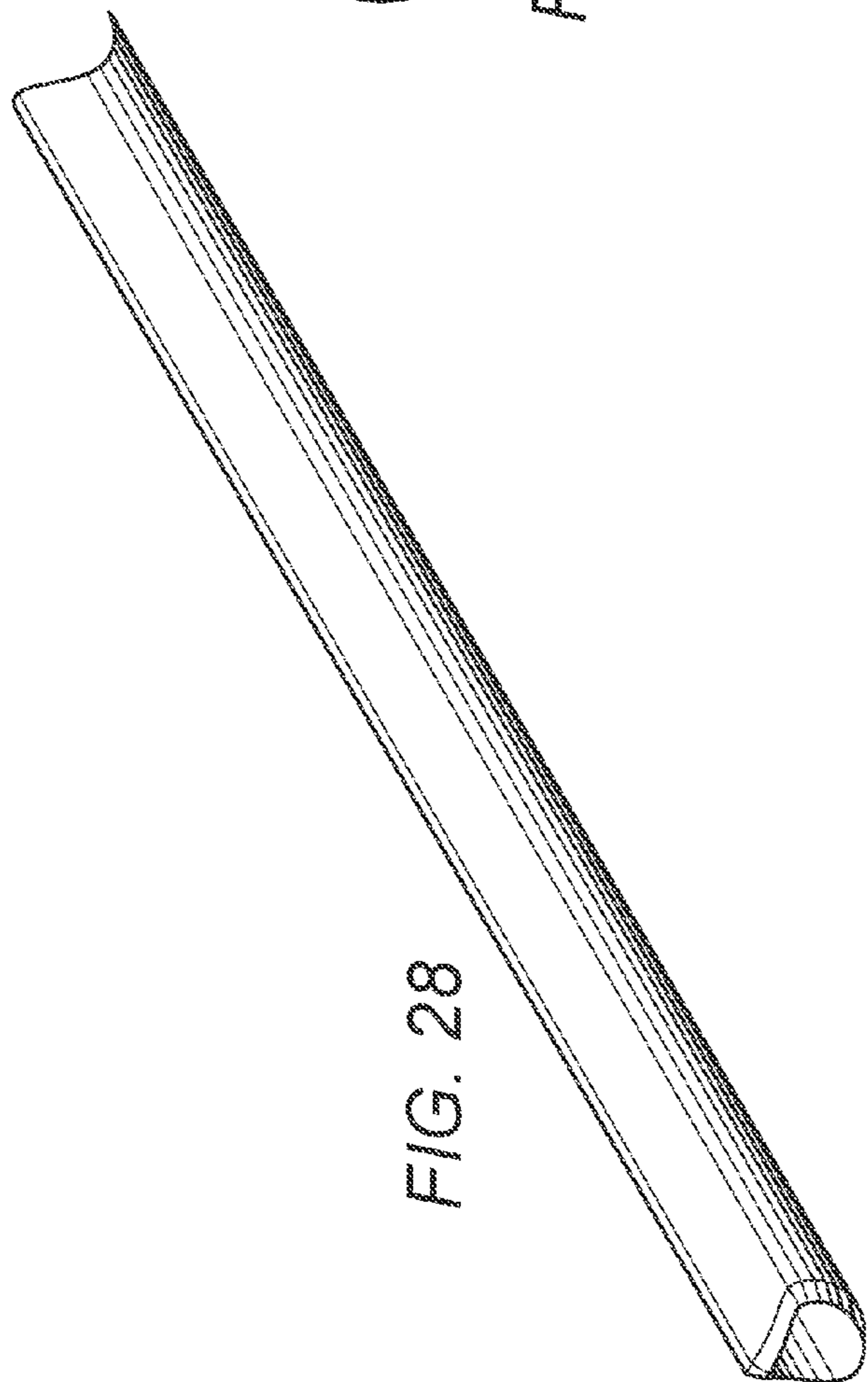

FIG. 28

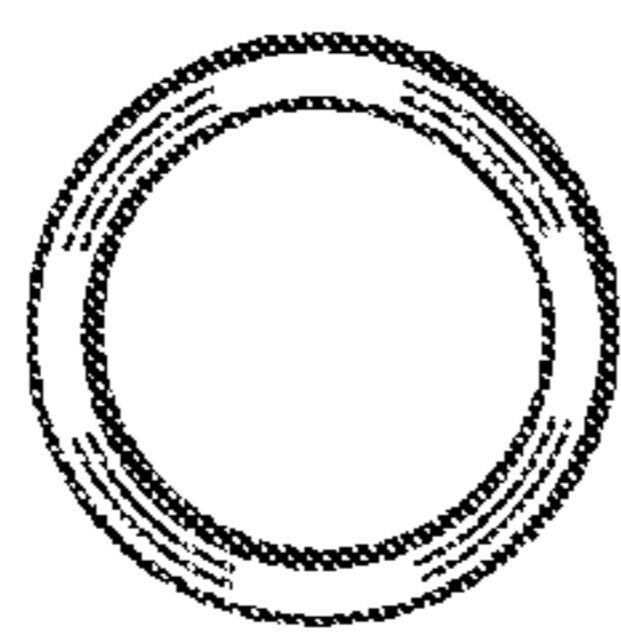

FIG. 29

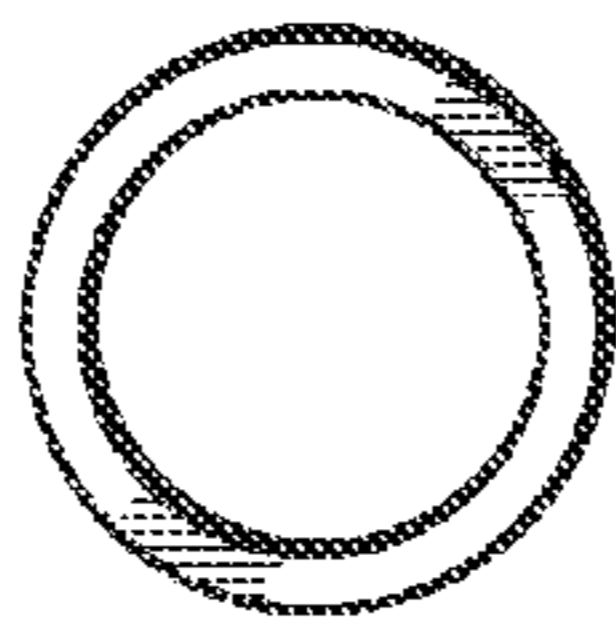

FIG. 30

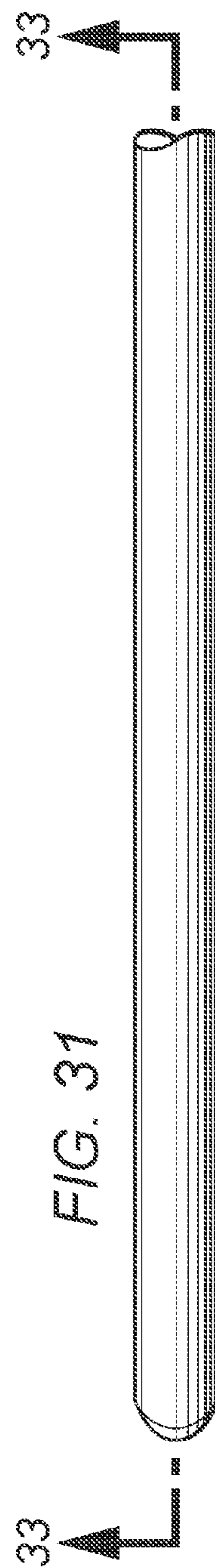

FIG. 31

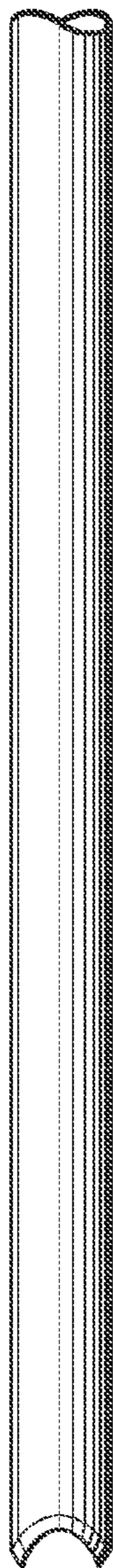

FIG. 32

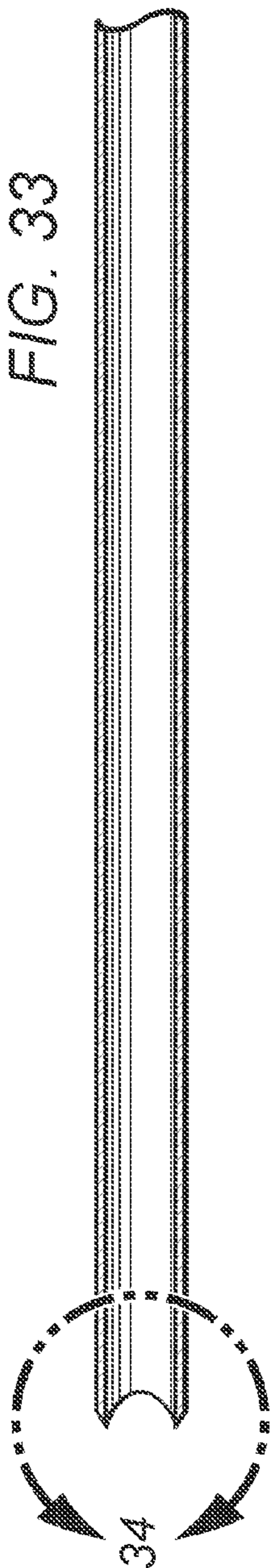

FIG. 33

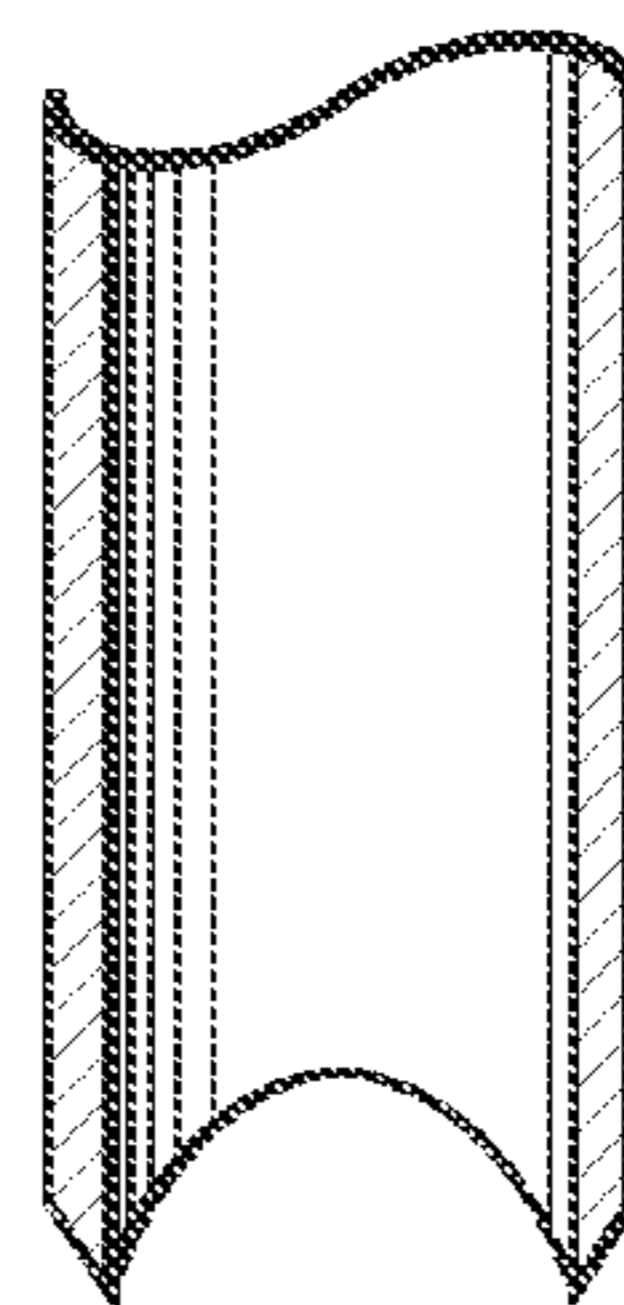

FIG. 34