



US00D749652S

(12) **United States Design Patent**
McConnell et al.

(10) **Patent No.:** **US D749,652 S**
(45) **Date of Patent:** **** Feb. 16, 2016**

(54) **APPLIANCE INTERIOR WITH COLOR**

(71) Applicant: **Whirlpool Corporation**, Benton Harbor, MI (US)

(72) Inventors: **Jessica R. McConnell**, St. Joseph, MI (US); **Daniel Henry Quinlan**, Stevensville, MI (US); **Kelly E. Roche**, St. Joseph, MI (US); **Michael S. Seeley**, South Haven, MI (US)

(73) Assignee: **Whirlpool Corporation**, Benton Harbor, MI (US)

(**) Term: **14 Years**

(21) Appl. No.: **29/485,319**

(22) Filed: **Mar. 18, 2014**

(51) **LOC (10) Cl.** **15-07**

(52) **U.S. Cl.**
USPC **D15/89**

(58) **Field of Classification Search**
USPC D15/79, 81, 84, 85, 86, 88, 89, 91
CPC F25D 2323/02; F25D 2323/021; F25D 2317/06; F25D 2317/062; F25D 2323/121; F25D 2323/122; F25D 2331/806; F25D 2400/36; F25D 13/02; F25D 13/04; F25D 11/02; F25D 11/025

See application file for complete search history.

(56) **References Cited**

U.S. PATENT DOCUMENTS

D508,249 S * 8/2005 Seok et al. D15/86
D511,177 S * 11/2005 Jackovin et al. D15/89
D511,179 S * 11/2005 Tunzi D15/89

(Continued)

Primary Examiner — Ian Simmons
Assistant Examiner — Khawaja Anwar

(57) **CLAIM**

I claim the ornamental design for an appliance interior with color, as shown and described.

DESCRIPTION

FIG. 1 is a perspective view of an appliance interior with color in a closed configuration according to our design; FIG. 2 is a front elevation view thereof; FIG. 3 is a left side elevation view thereof; FIG. 4 is a top plan view thereof; FIG. 5 is a bottom plan view thereof; FIG. 6 is a front elevation view of the appliance interior with color of FIG. 1 shown in an open configuration; FIG. 7 is an enlarged top left perspective view thereof; FIG. 8 is an enlarged top right perspective view thereof; FIG. 9 is a front elevation view thereof; FIG. 10 is a partial left perspective view thereof; FIG. 11 is a partial front elevation view thereof; FIG. 12 is a partial left perspective view thereof in a first use condition of the open configuration; FIG. 13 is a partial front elevation view of a right portion thereof; FIG. 14 is a partial right perspective view thereof; FIG. 15 is a partial front elevation view thereof; FIG. 16 is a partial right perspective view thereof in a second use condition of the open configuration; and, FIG. 17 is a partial front elevation view thereof.

The broken lines in the figures are to show an environment and form no part of the claimed design.

The comparatively dark-tone fill on the interior refrigerator compartment walls shown in FIGS. 6-9 is used to indicate a charcoal gray color having the following color characteristics:

H: 0
S: 0
V: 28 (+/-5%).

The comparatively light tone fill on the door bin shown in FIGS. 6, 12 and 13 is used to indicate a matte silver color having a metallic appearance and having the following color characteristics:

H: 0
S: 0
V: 78 (+/-7%).

1 Claim, 16 Drawing Sheets

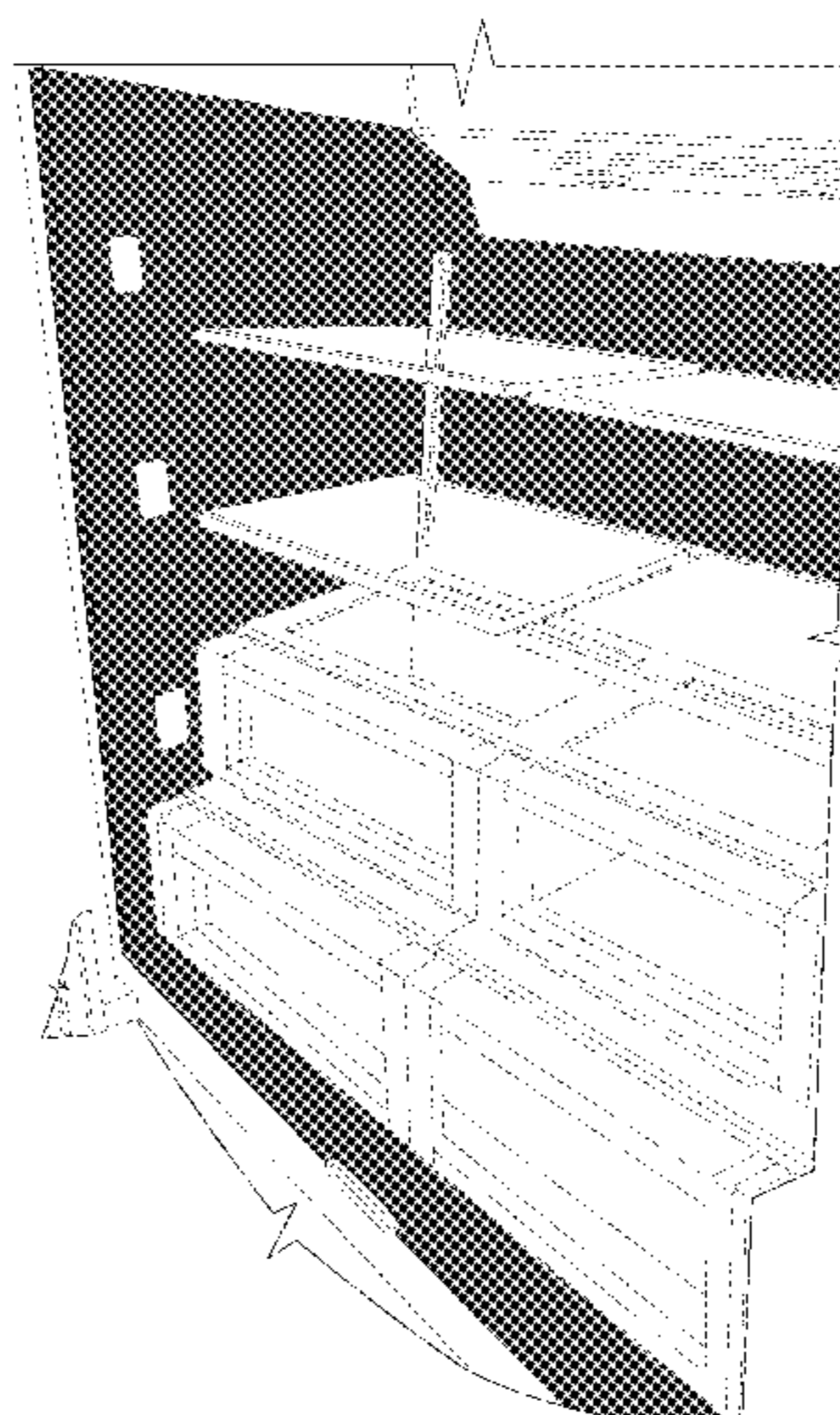
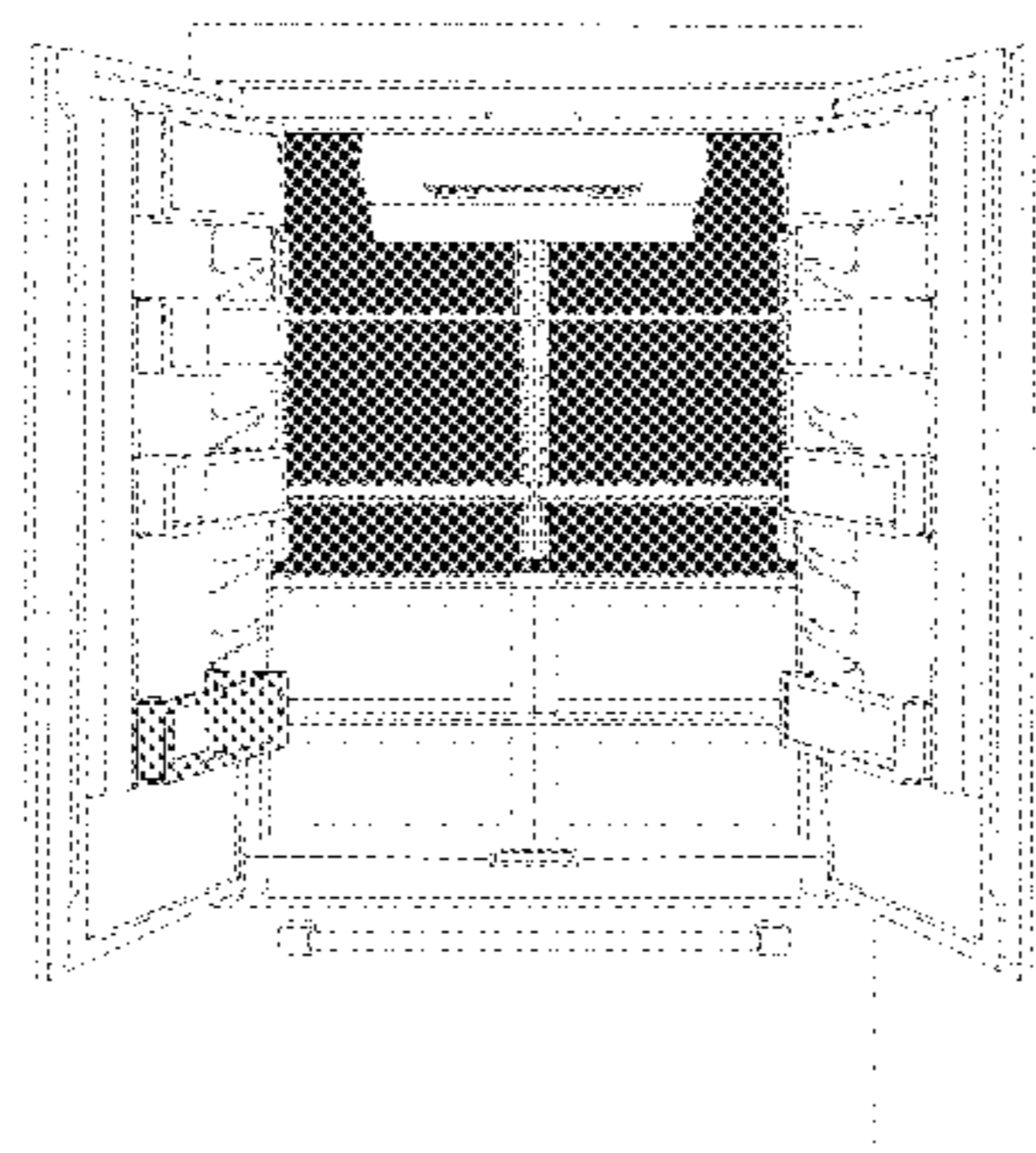

(56)

References Cited

U.S. PATENT DOCUMENTS

D518,832 S * 4/2006 Park et al. D15/85
D629,819 S * 12/2010 Placke et al. D15/89
D639,315 S * 6/2011 Yang et al. D15/85
D647,927 S * 11/2011 Lee et al. D15/85
D654,515 S * 2/2012 Hwang et al. D15/85

D655,321 S * 3/2012 Lee et al. D15/86
D707,735 S * 6/2014 Cho et al. D15/91
D710,401 S * 8/2014 Ringemann et al. D15/85
D710,402 S * 8/2014 Jeon et al. D15/86
D716,851 S * 11/2014 Seo et al. D15/89
D718,346 S * 11/2014 Cho et al. D15/81
D718,349 S * 11/2014 Cho et al. D15/85

* cited by examiner

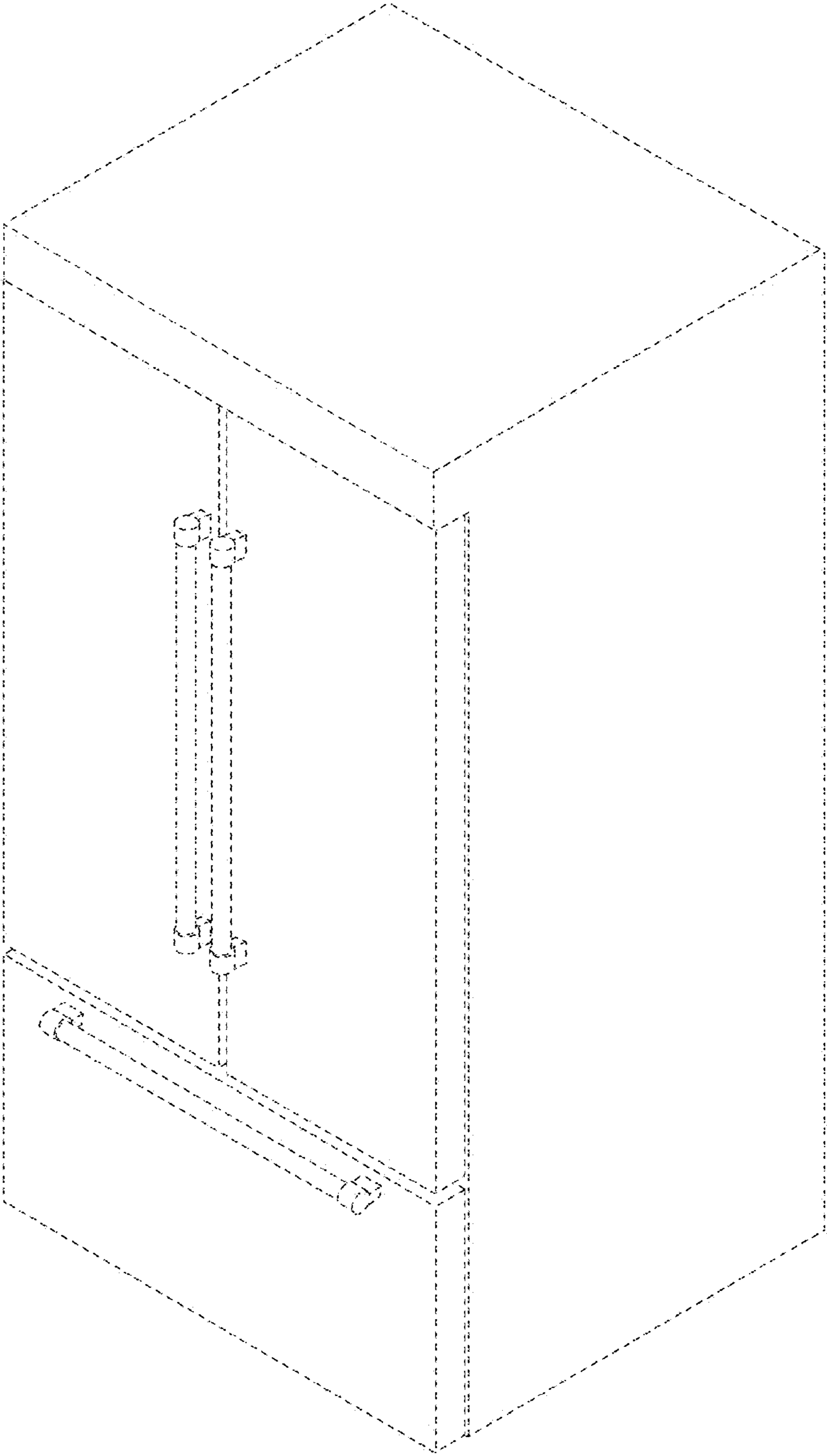

FIG. 1

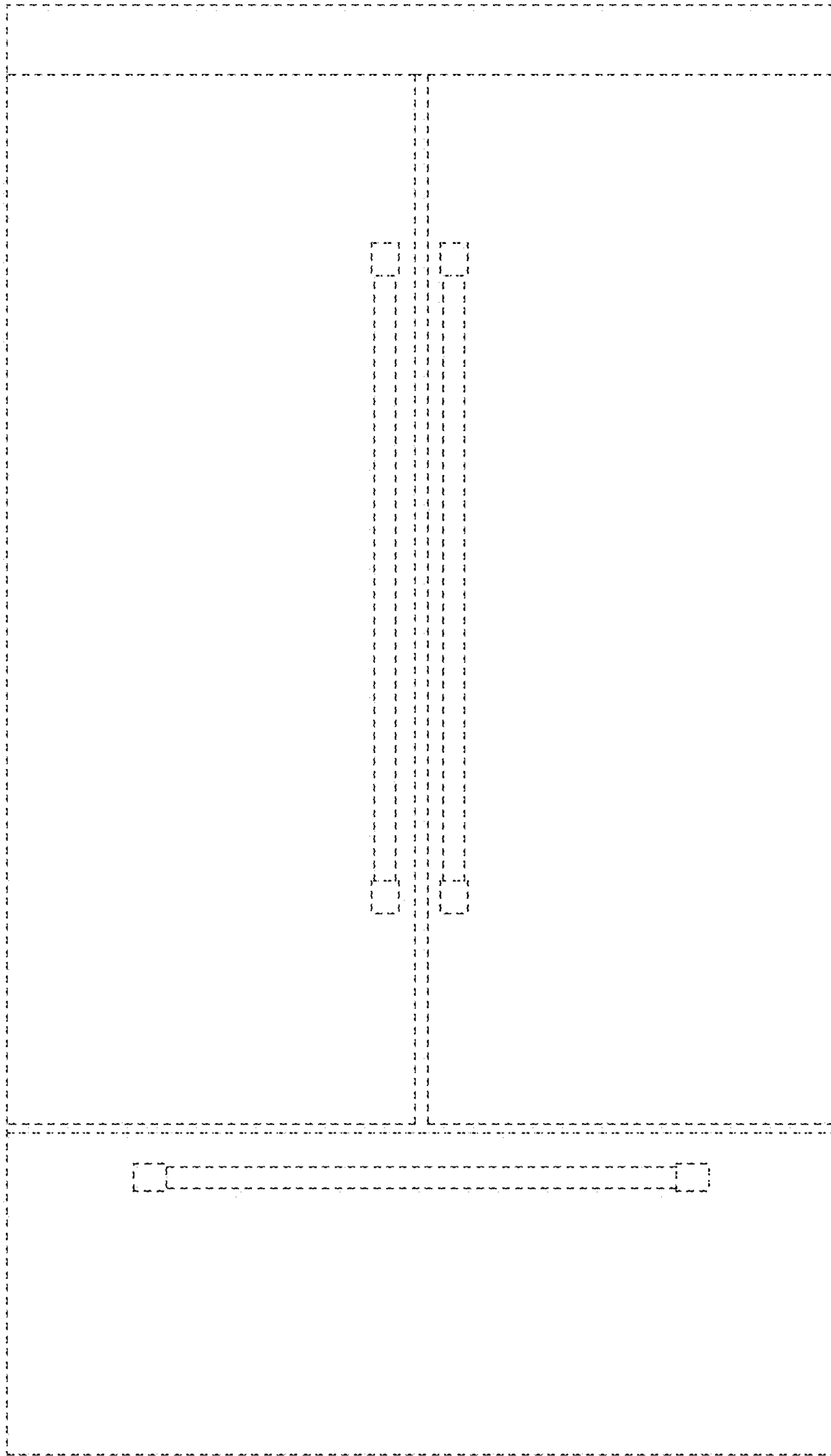

FIG. 2

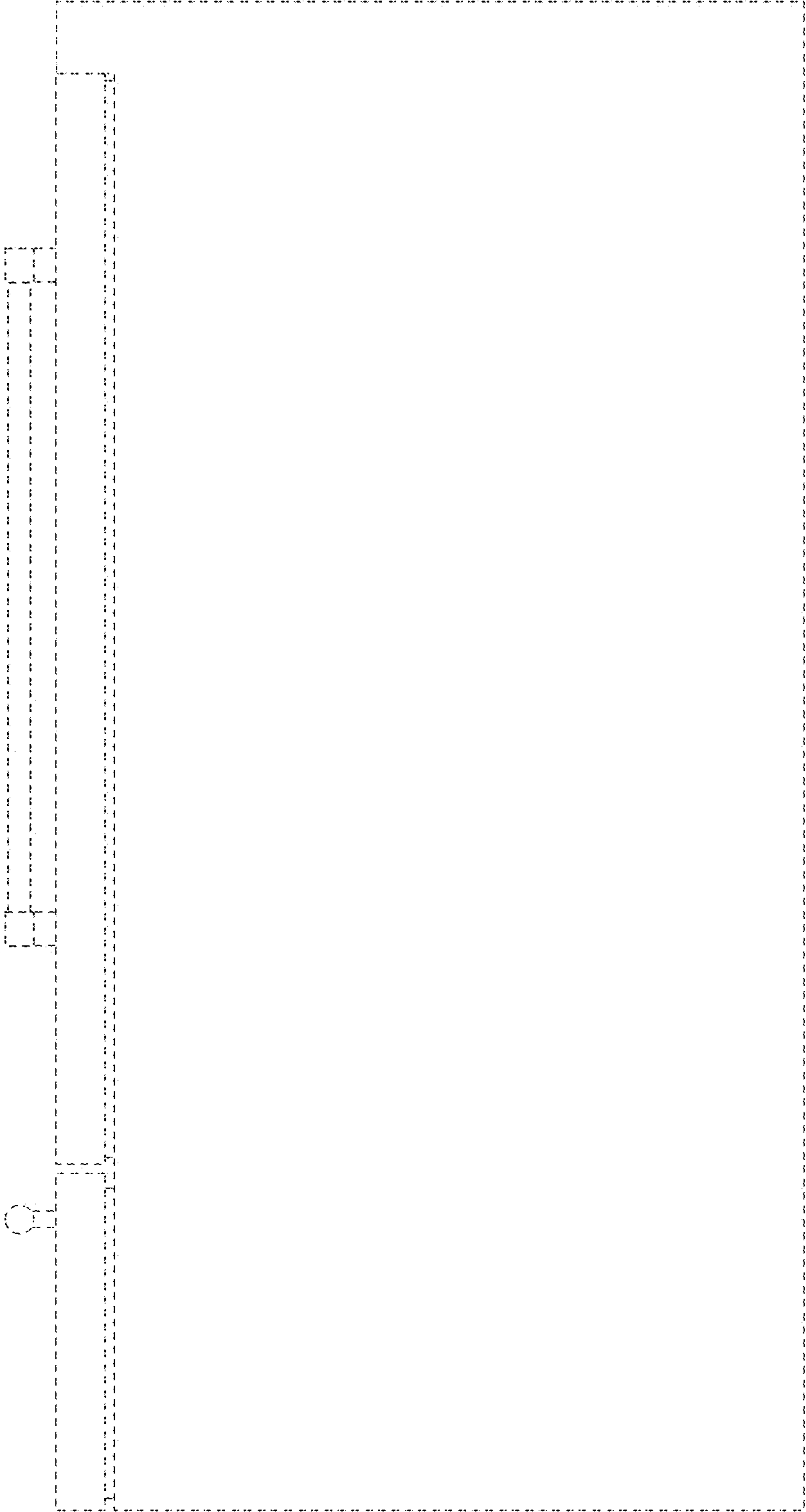

FIG. 3

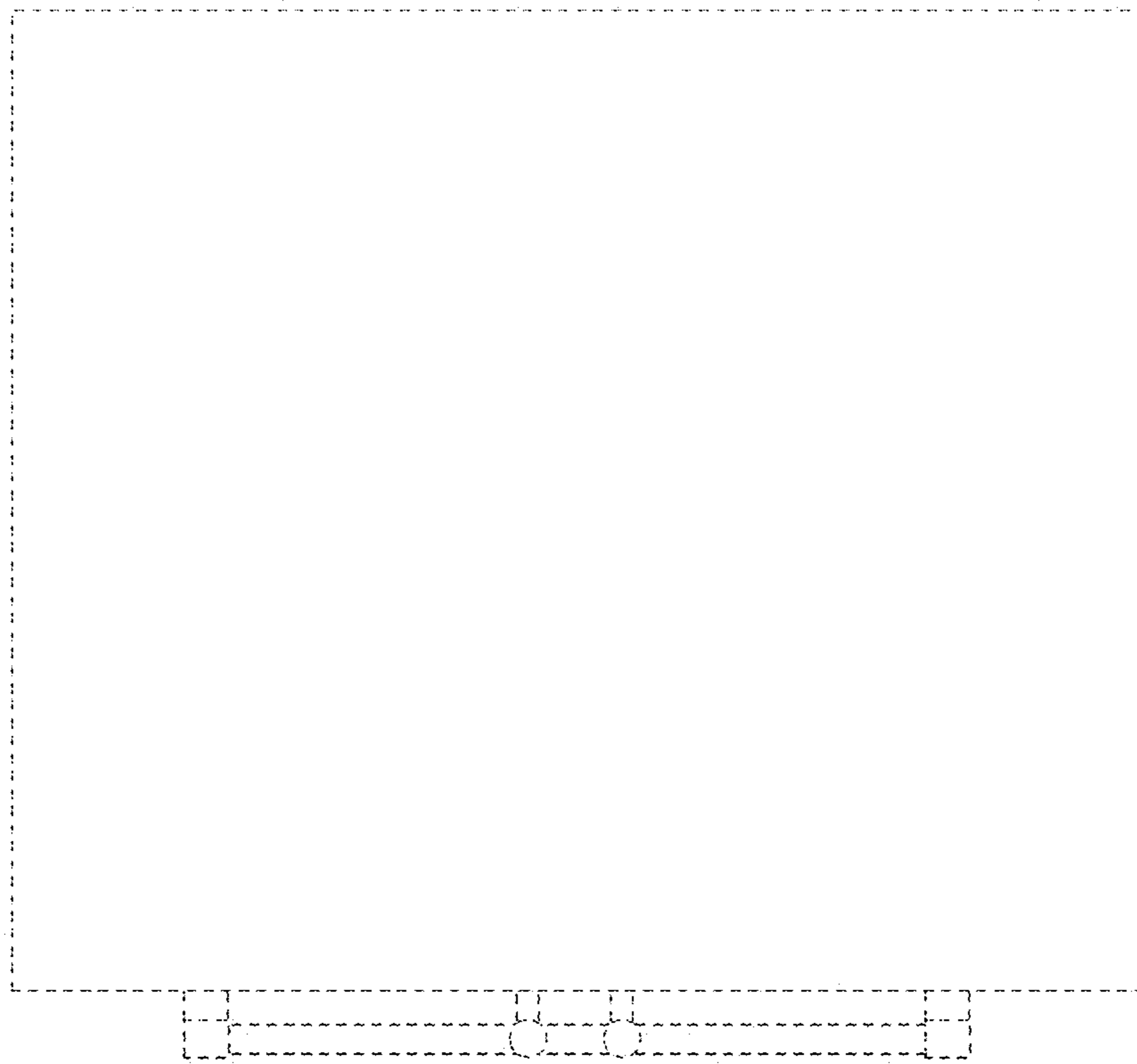

FIG. 4

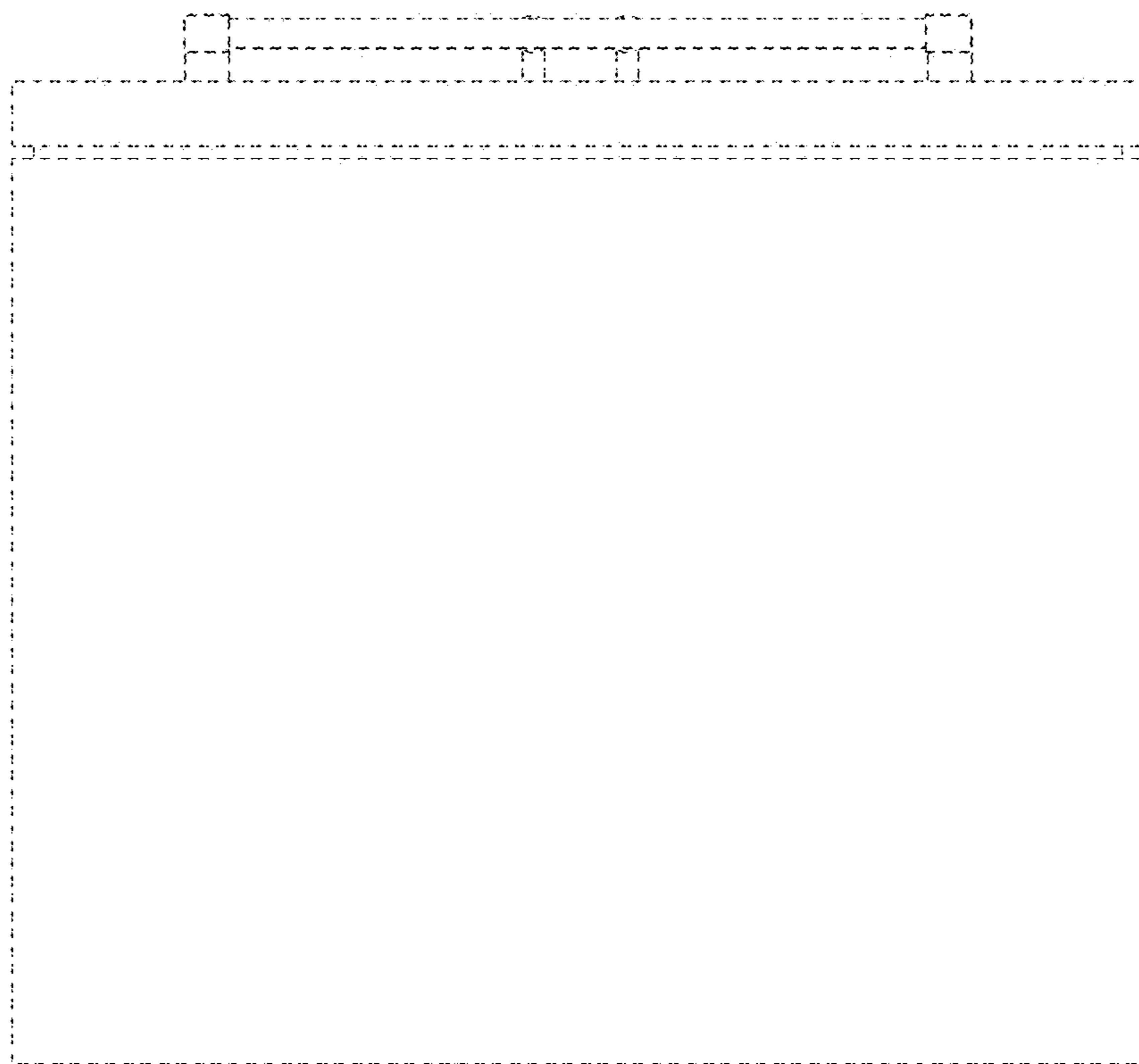

FIG. 5

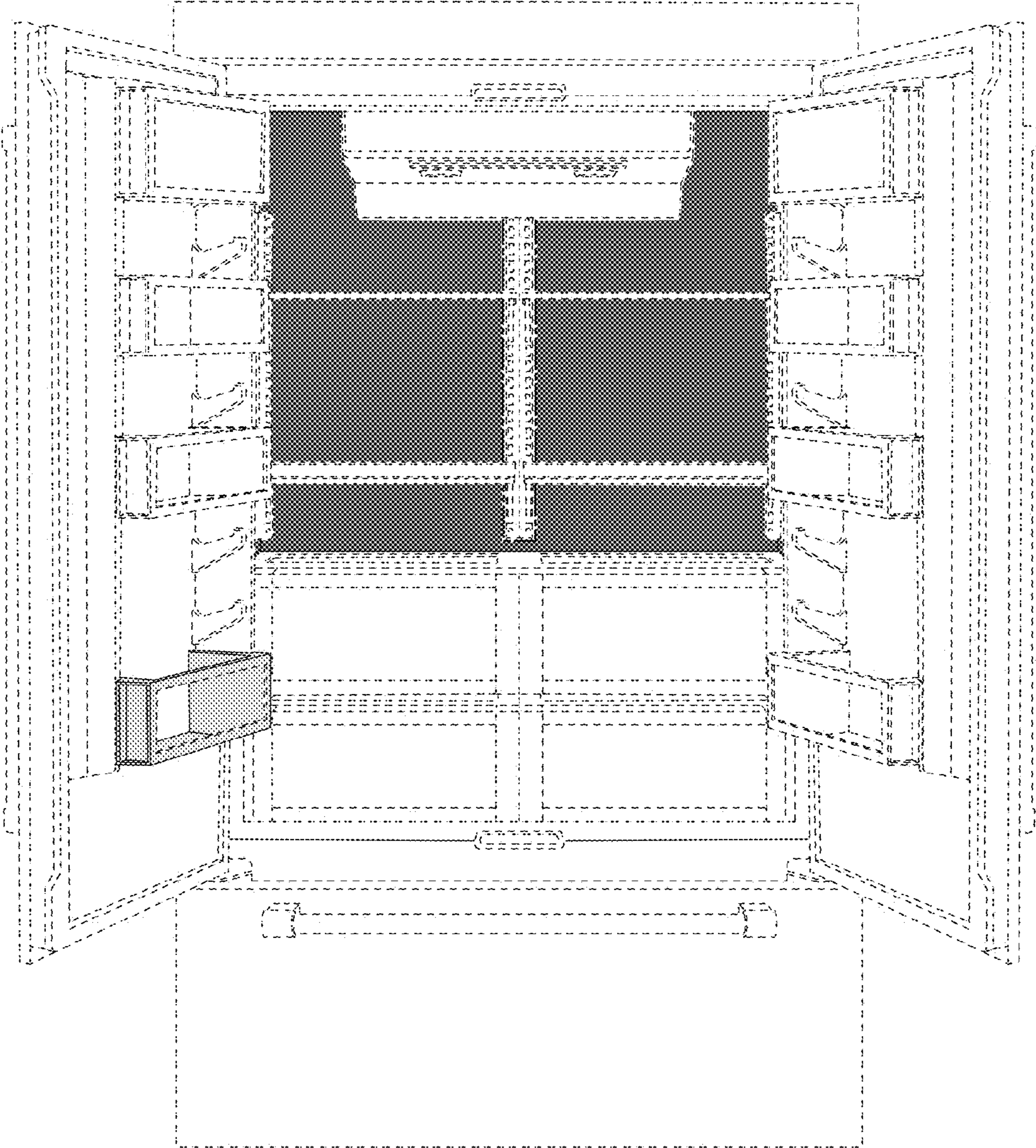

FIG. 6

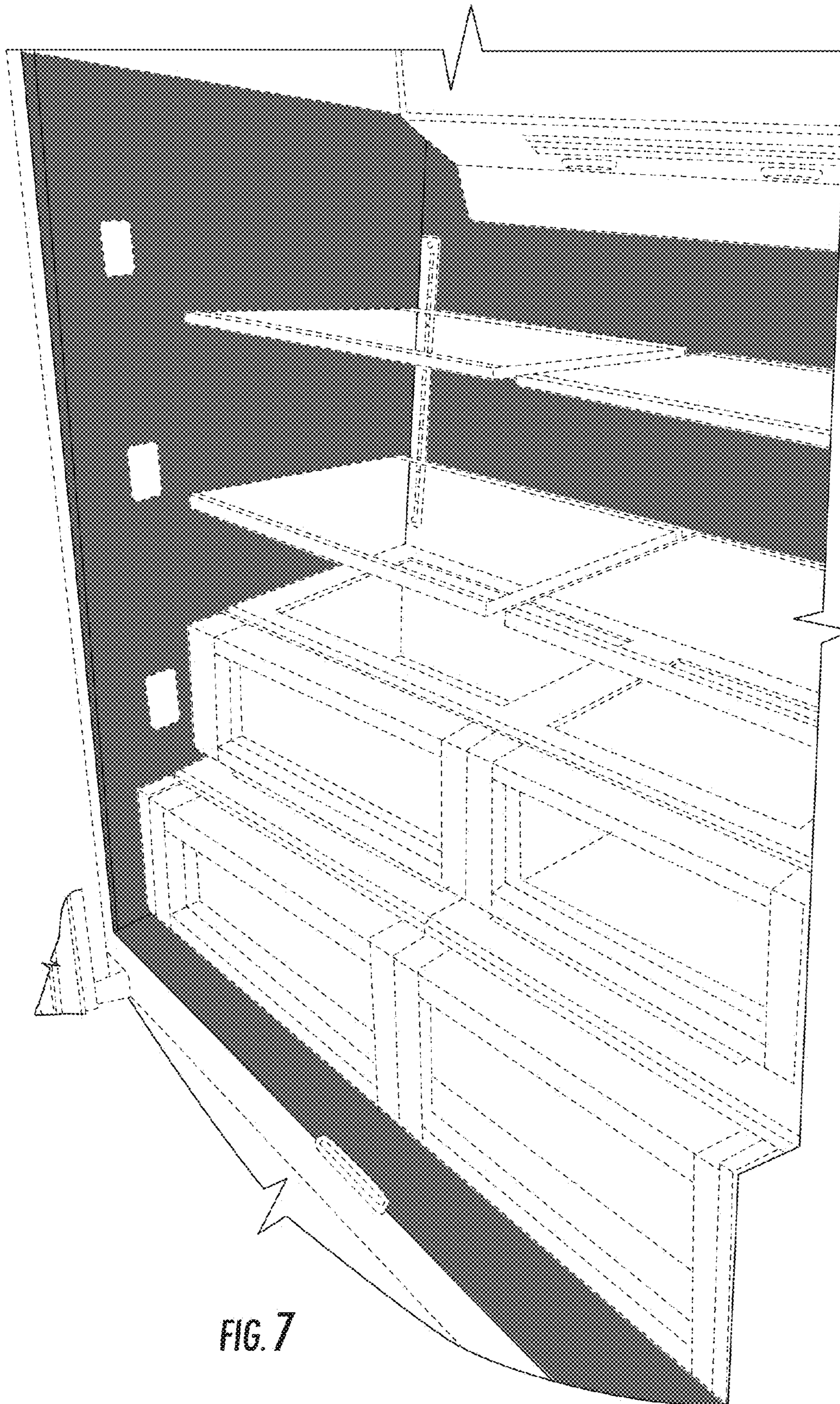
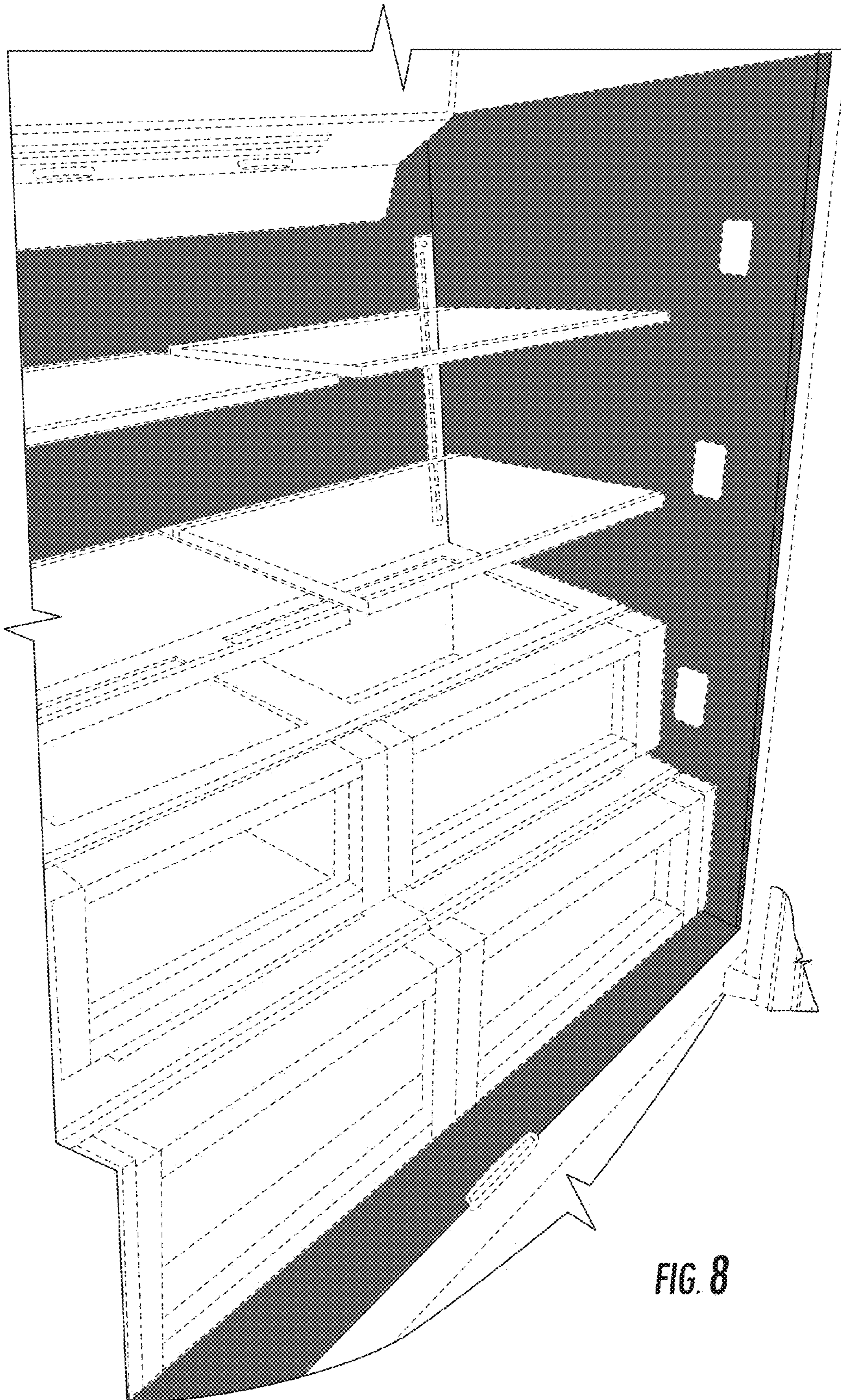

FIG. 7



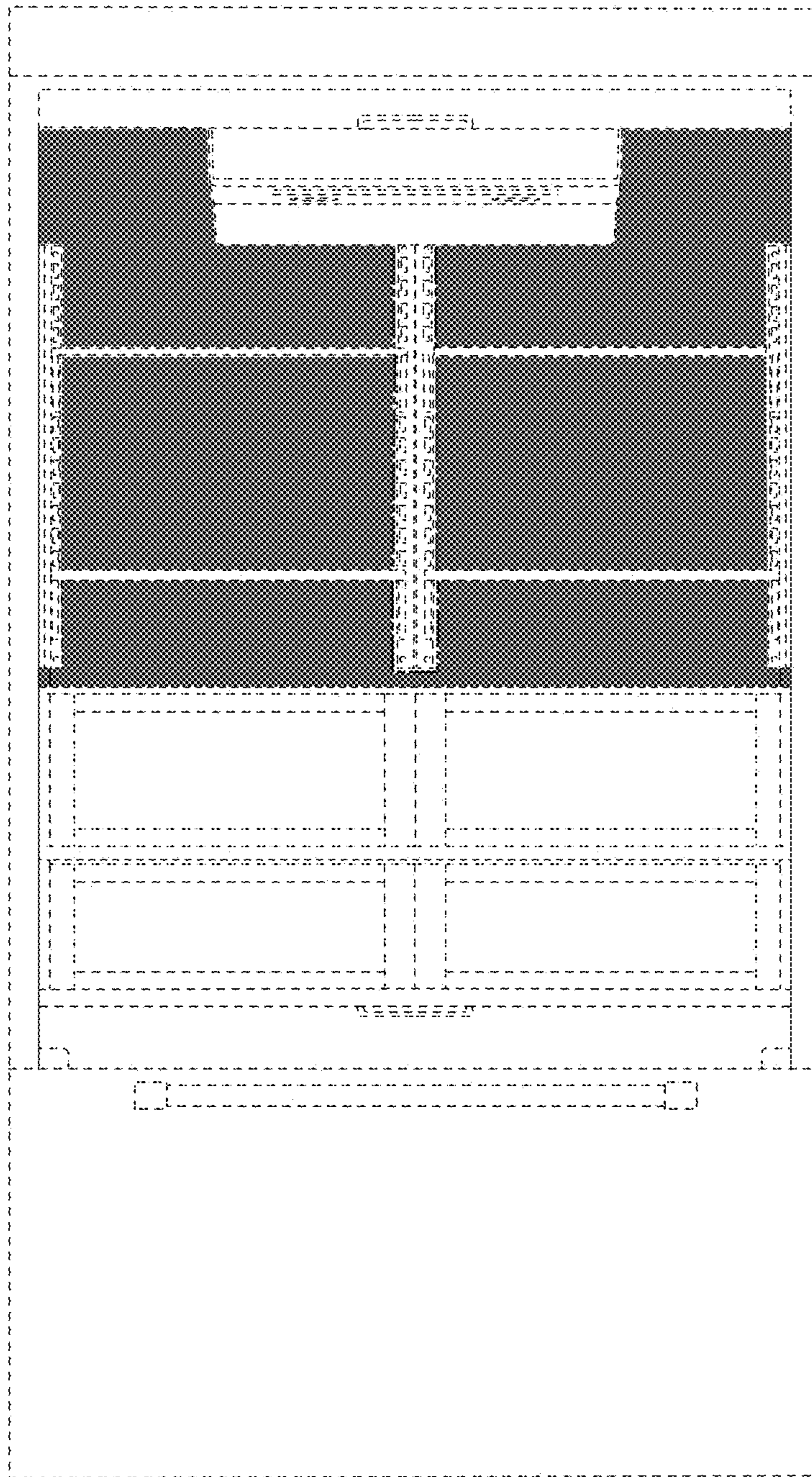

FIG. 9

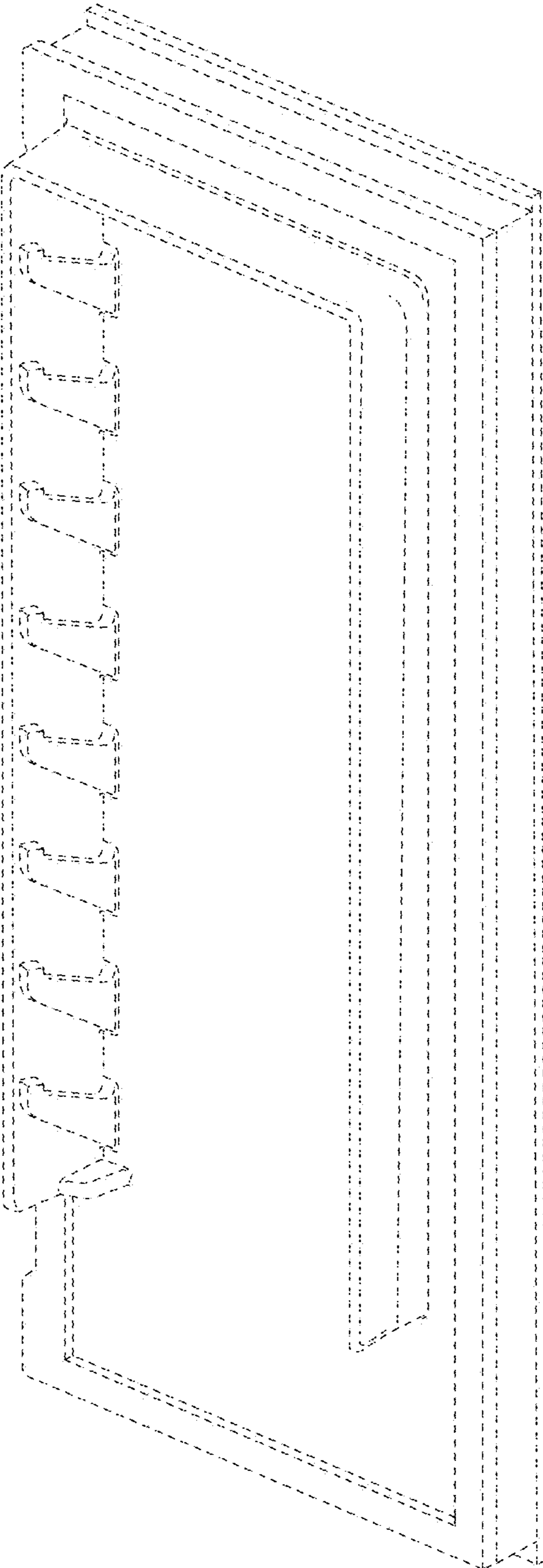

FIG. 10

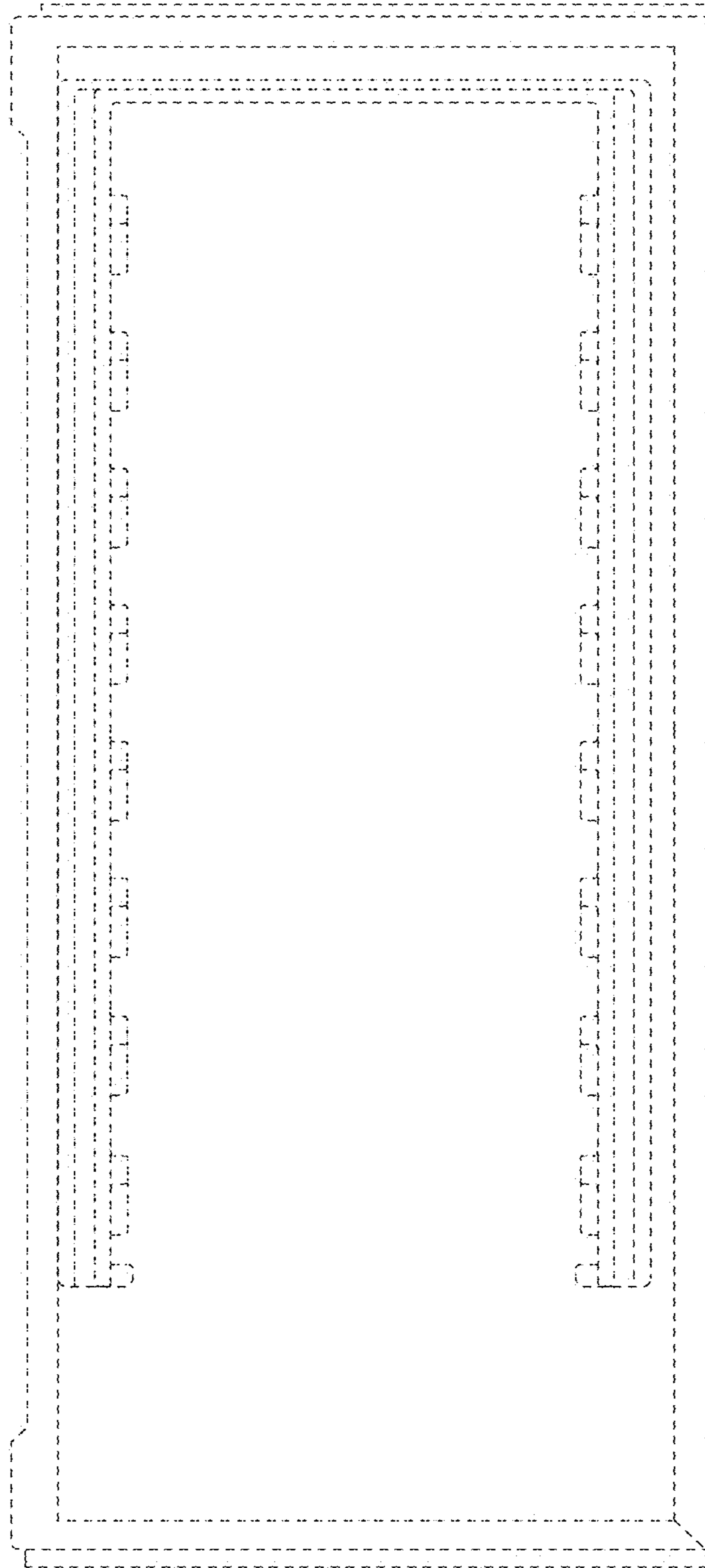

FIG. 11

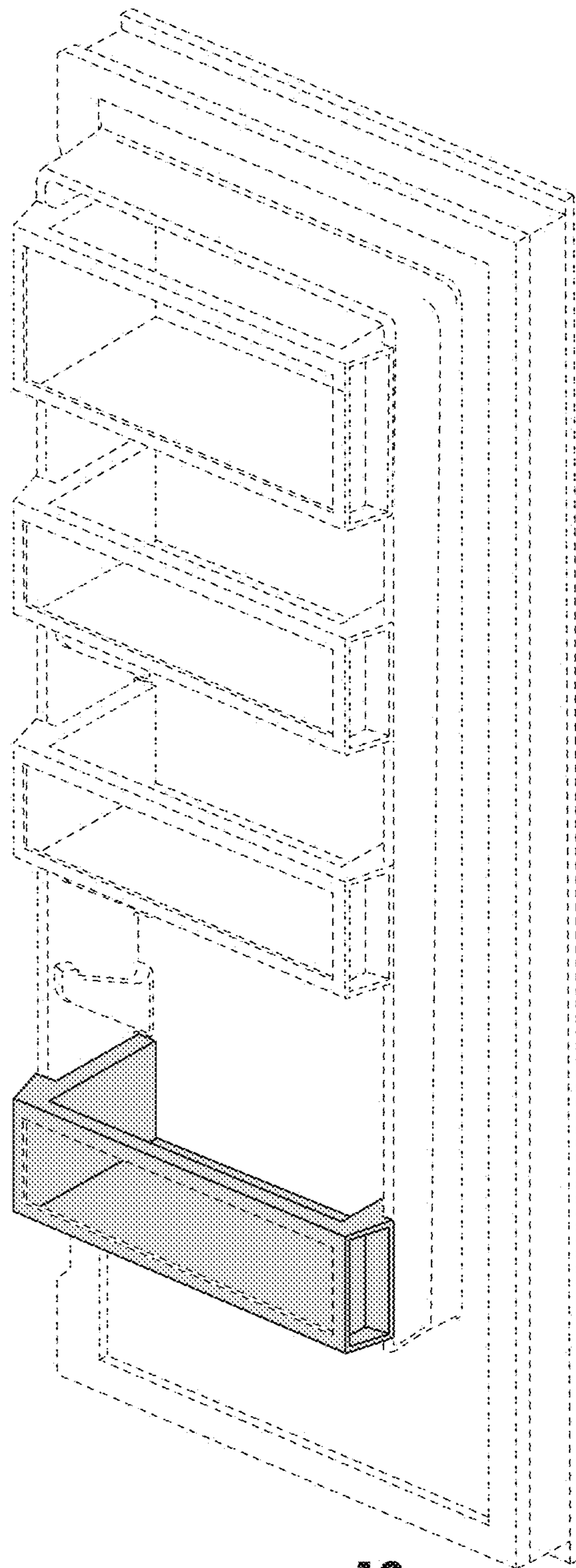

FIG. 12

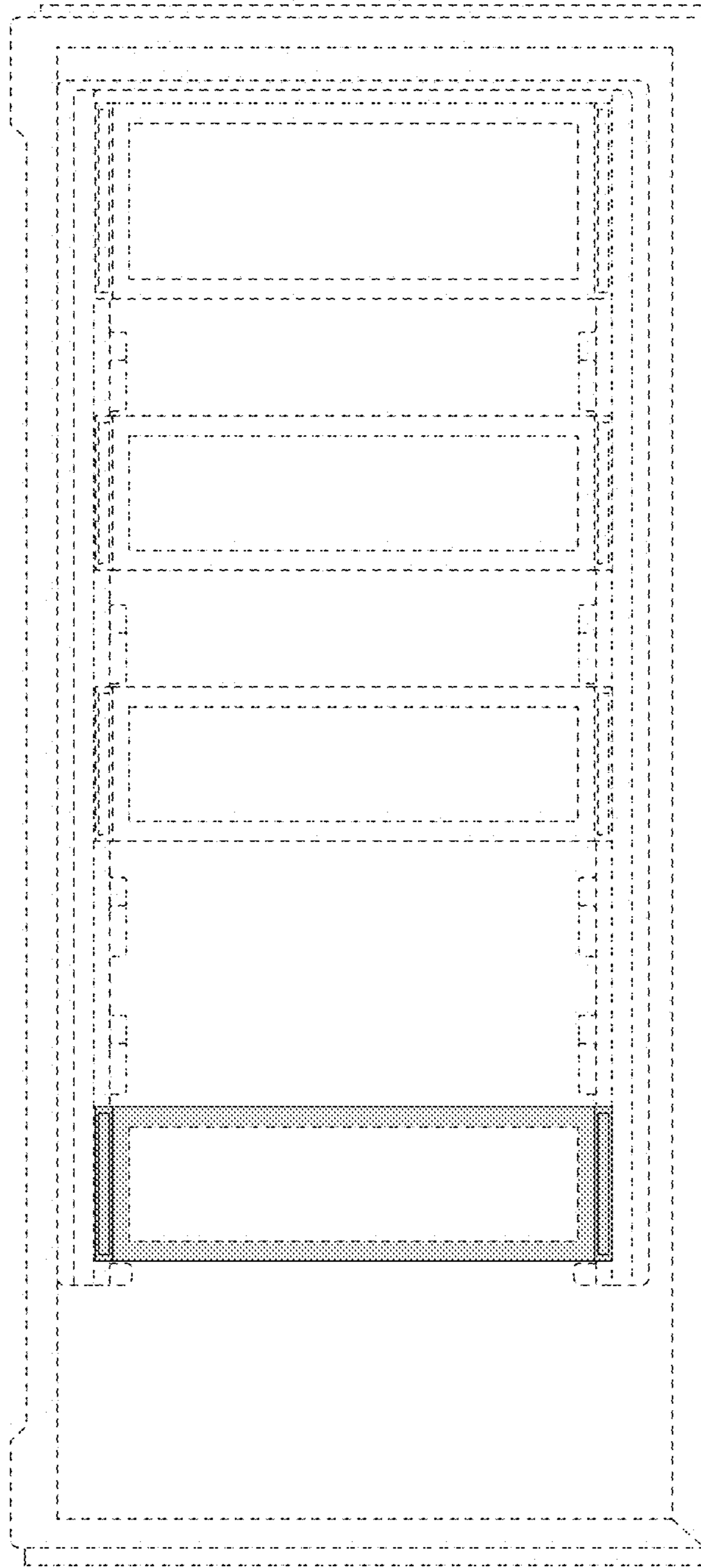

FIG. 13

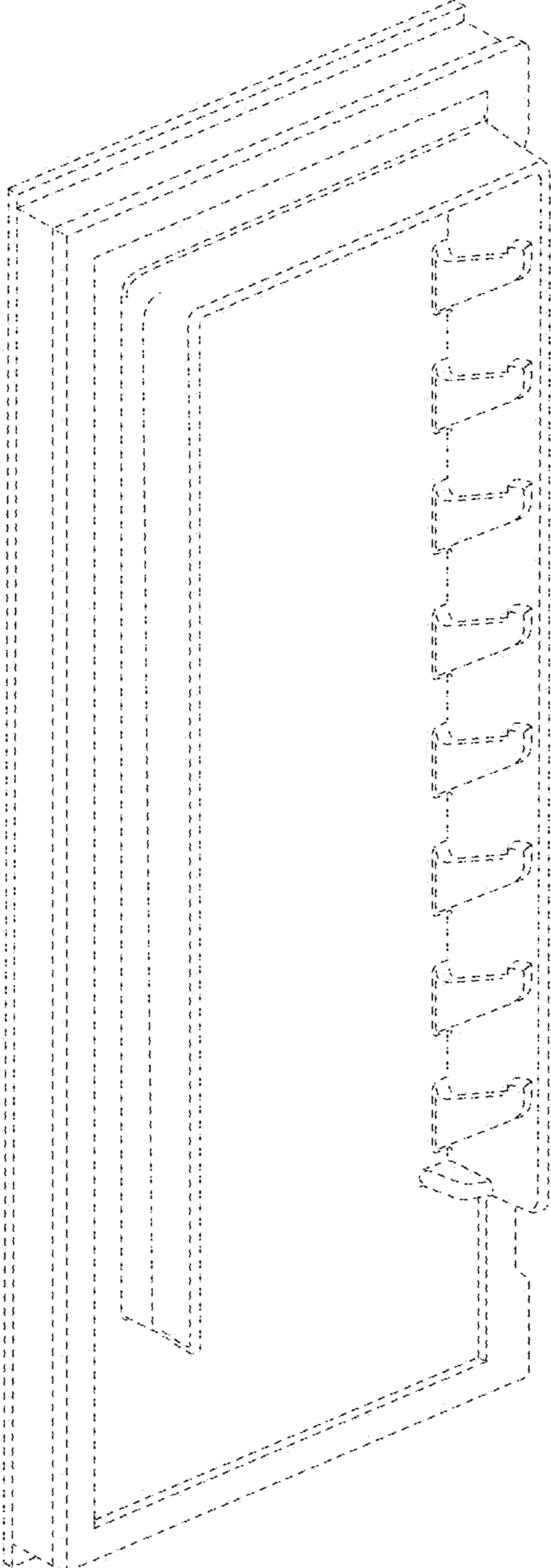

FIG. 14

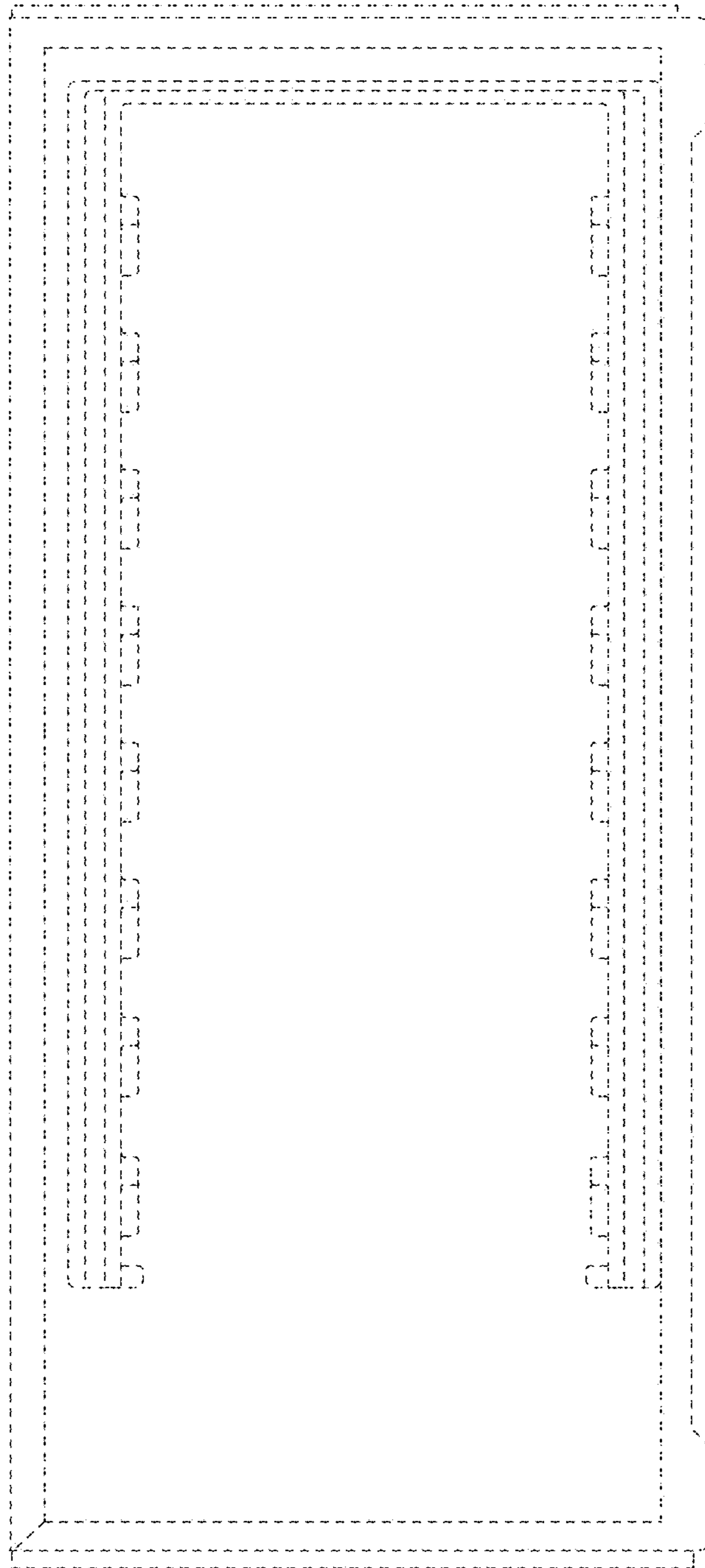

FIG. 15

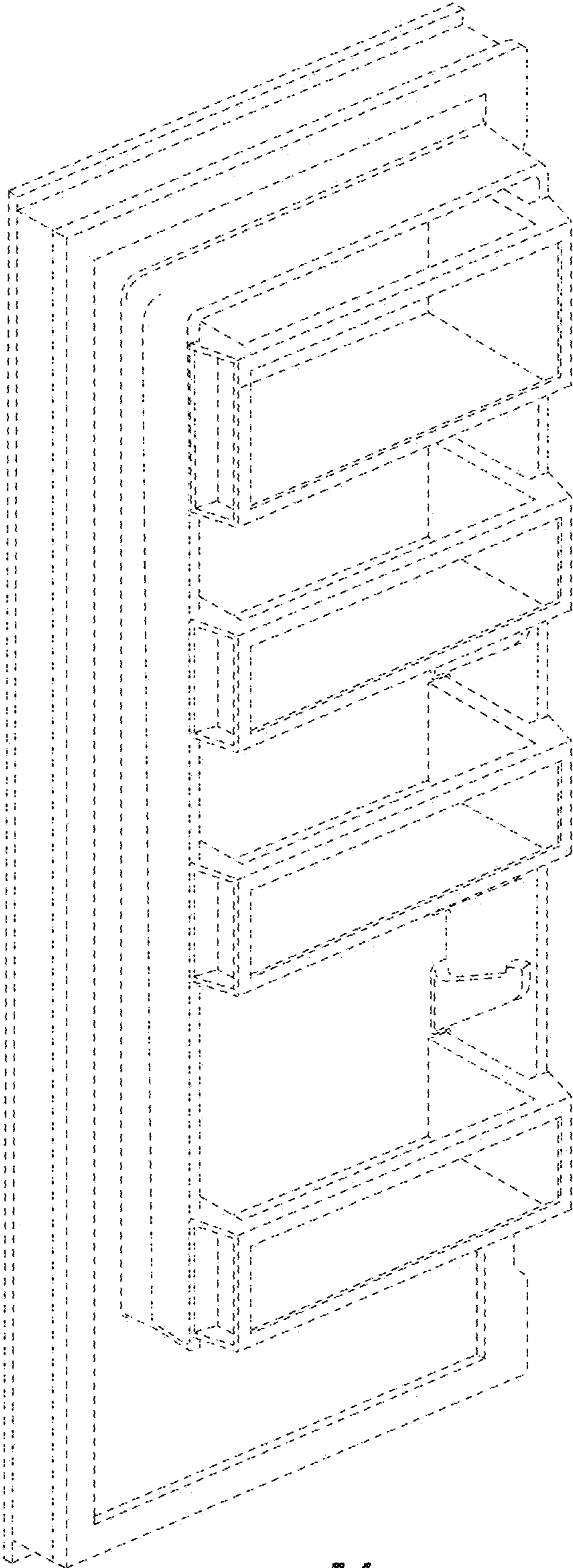

FIG. 16

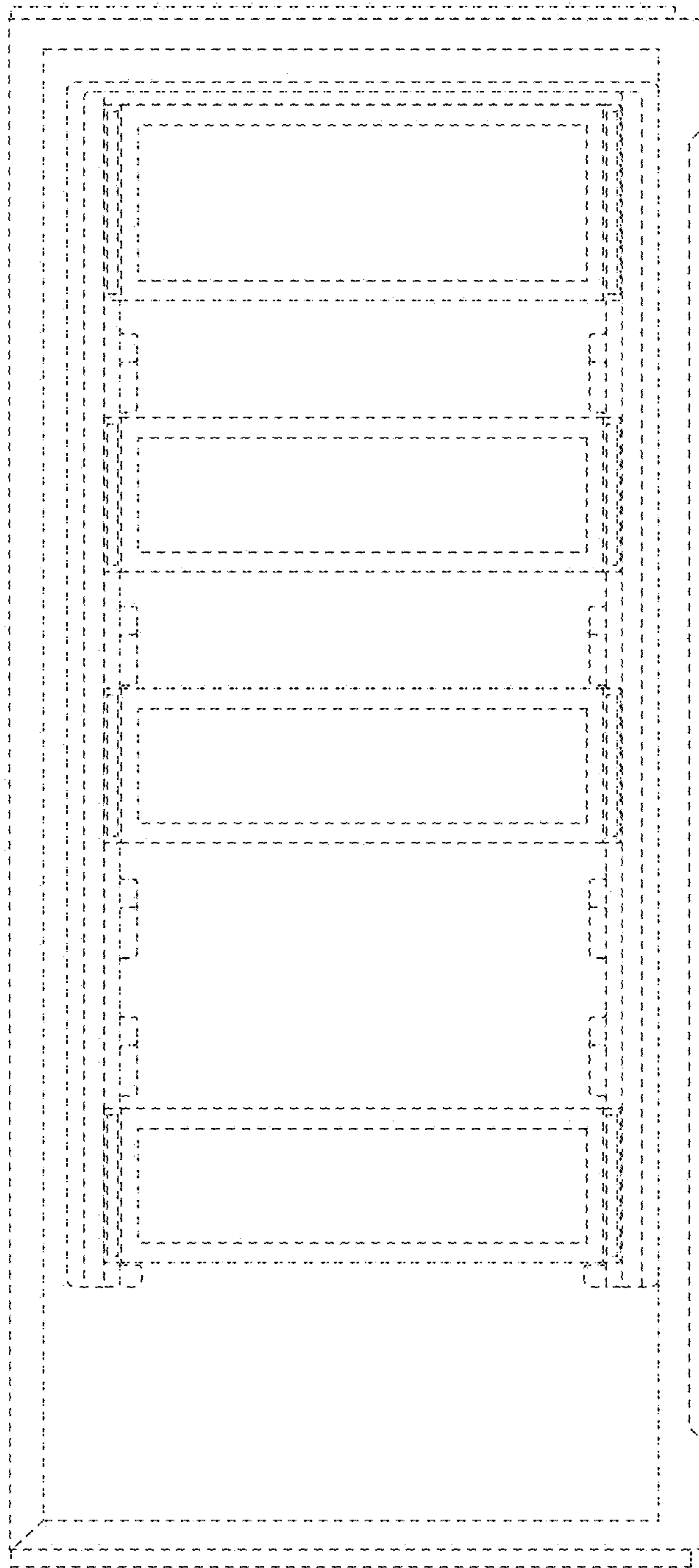

FIG. 17