



US00D749632S

(12) **United States Design Patent**
Park et al.

(10) **Patent No.:** **US D749,632 S**

(45) **Date of Patent:** **** Feb. 16, 2016**

(54) **DISPLAY SCREEN PORTION WITH ICON**

(71) Applicant: **Samsung Electronics Co., Ltd.**,
Suwon-si, Gyeonggi-do (KR)

(72) Inventors: **Hye-Bin Park**, Seoul (KR); **You-Jin Im**,
Seoul (KR); **Sora Kim**, Seoul (KR);
Joo-Hyung Lee, Seoul (KR)

(73) Assignee: **SAMSUNG ELECTRONICS CO.,
LTD.** (KR)

(**) Term: **14 Years**

(21) Appl. No.: **29/465,897**

(22) Filed: **Sep. 3, 2013**

(51) **LOC (10) Cl.** **14-04**

(52) **U.S. Cl.**
USPC **D14/489**; D14/490; D14/492

(58) **Field of Classification Search**
USPC D14/485–495; D16/200, 219
CPC G06F 3/01; G06F 3/0481; G06F 3/0482;
G06F 3/0484; H04N 5/232; H04N 5/23241;
H04N 5/3577; H04N 1/00127; H04N 1/00326
See application file for complete search history.

(56) **References Cited**

U.S. PATENT DOCUMENTS

D503,721 S *	4/2005	Peter et al.	D14/489
D588,151 S *	3/2009	Okada	D14/488
D623,195 S *	9/2010	La et al.	D14/489
D650,796 S *	12/2011	Rincover et al.	D14/492
D667,451 S *	9/2012	Wujcik et al.	D14/492
D667,452 S *	9/2012	Wujcik et al.	D14/492
D667,453 S *	9/2012	Wujcik et al.	D14/492
D667,457 S *	9/2012	Wujcik et al.	D14/492
D676,868 S *	2/2013	Wagner	D14/489
D677,275 S *	3/2013	Wujcik et al.	D14/492
D677,278 S *	3/2013	Wujcik et al.	D14/492
D677,326 S *	3/2013	Gleasant et al.	D18/27
D681,663 S *	5/2013	Phelan et al.	D14/488

D688,703 S *	8/2013	Phelan	D14/492
D698,800 S *	2/2014	Jung	D14/486
D704,212 S *	5/2014	Dellinger	D14/487
D704,221 S *	5/2014	Ma et al.	D14/492
D706,299 S *	6/2014	Ma et al.	D14/492
D709,088 S *	7/2014	Barcheck et al.	D14/489
D717,314 S *	11/2014	Lim et al.	D14/485
D722,078 S *	2/2015	Talbot et al.	D14/488
D722,080 S *	2/2015	Sano et al.	D14/489
D722,324 S *	2/2015	Florence et al.	D14/488
D726,763 S *	4/2015	Moon et al.	D14/492

(Continued)

OTHER PUBLICATIONS

Ribbons, Mee Rebirth, published Apr. 4, 2013 [online]. Site accessed Sep. 10, 2015, available online at <URL: <https://365webresources.com/15-psd-web-ribbons-free-download/>>.*

(Continued)

Primary Examiner — Cathron Brooks

Assistant Examiner — Daniel J Domino

(74) *Attorney, Agent, or Firm* — Cantor Colburn LLP

(57) **CLAIM**

We claim, the ornamental design for a display screen portion with icon, as shown and described.

DESCRIPTION

FIG. 1 is a front view of a display screen portion with icon showing our new design;

FIG. 2 is a second embodiment thereof;

FIG. 3 is a third embodiment thereof;

FIG. 4 is a fourth embodiment thereof;

FIG. 5 is a fifth embodiment thereof;

FIG. 6 is a sixth embodiment thereof; and,

FIG. 7 is a seventh embodiment thereof.

The broken lines shown are for the purpose of illustrating portions of the display screen portion with icon, and form no part of the claimed design.

1 Claim, 7 Drawing Sheets

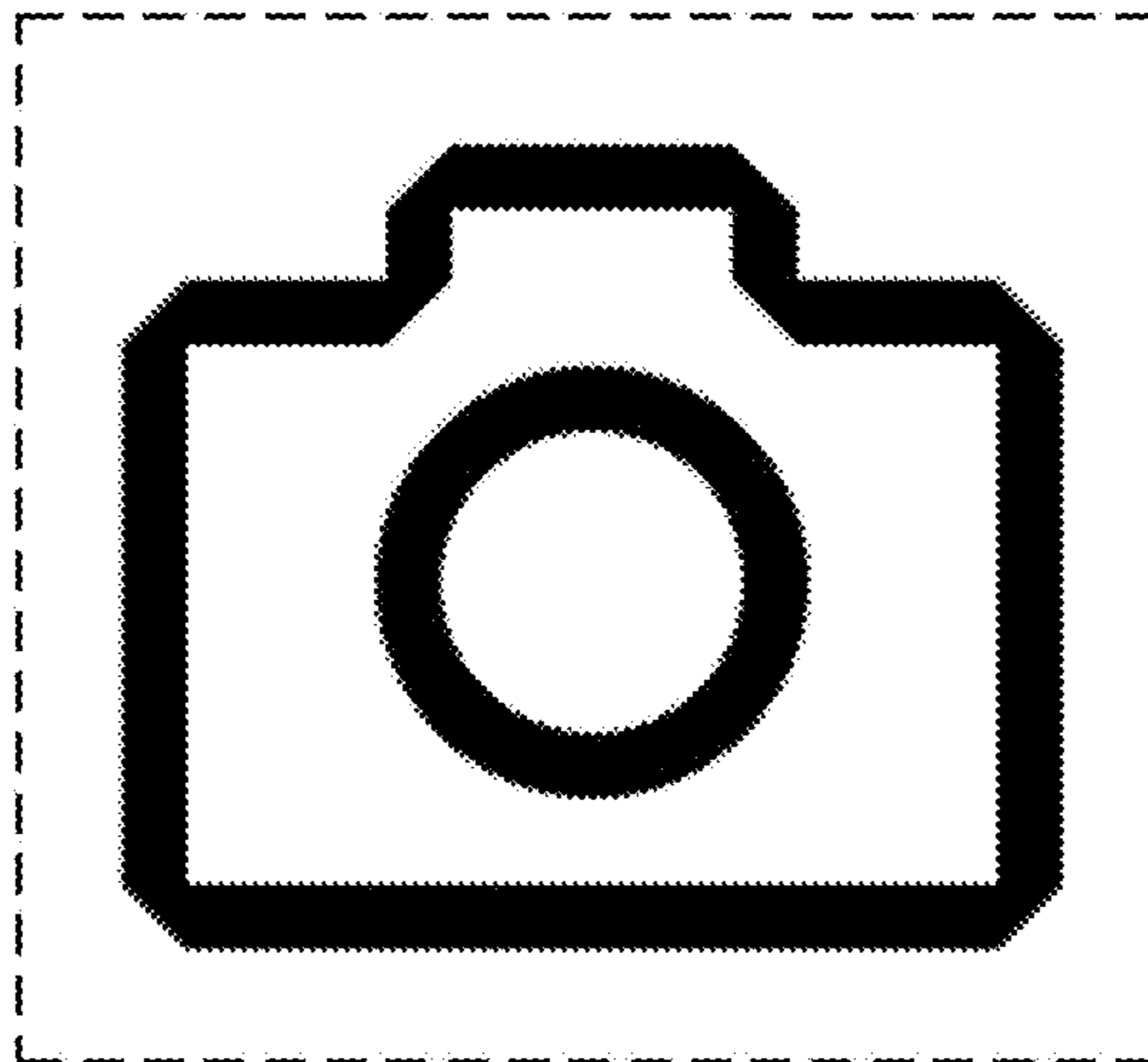

(56)

References Cited

U.S. PATENT DOCUMENTS

D726,764 S * 4/2015 Oh et al. D14/492
D727,355 S * 4/2015 Ma et al. D14/492
D727,356 S * 4/2015 Oh D14/492
2009/0265657 A1* 10/2009 Bamford et al. 715/786
2011/0083103 A1* 4/2011 Shim et al. 715/810
2012/0069231 A1* 3/2012 Chao 348/333.01

OTHER PUBLICATIONS

Texture, Creative Nerds, published Mar. 12, 2011 [online]. Site accessed Sep. 10, 2015, available online at <URL: <http://www.iconarchive.com/show/wooden-social-icons-by-creativenerds.html>>.*

* cited by examiner

FIG. 1

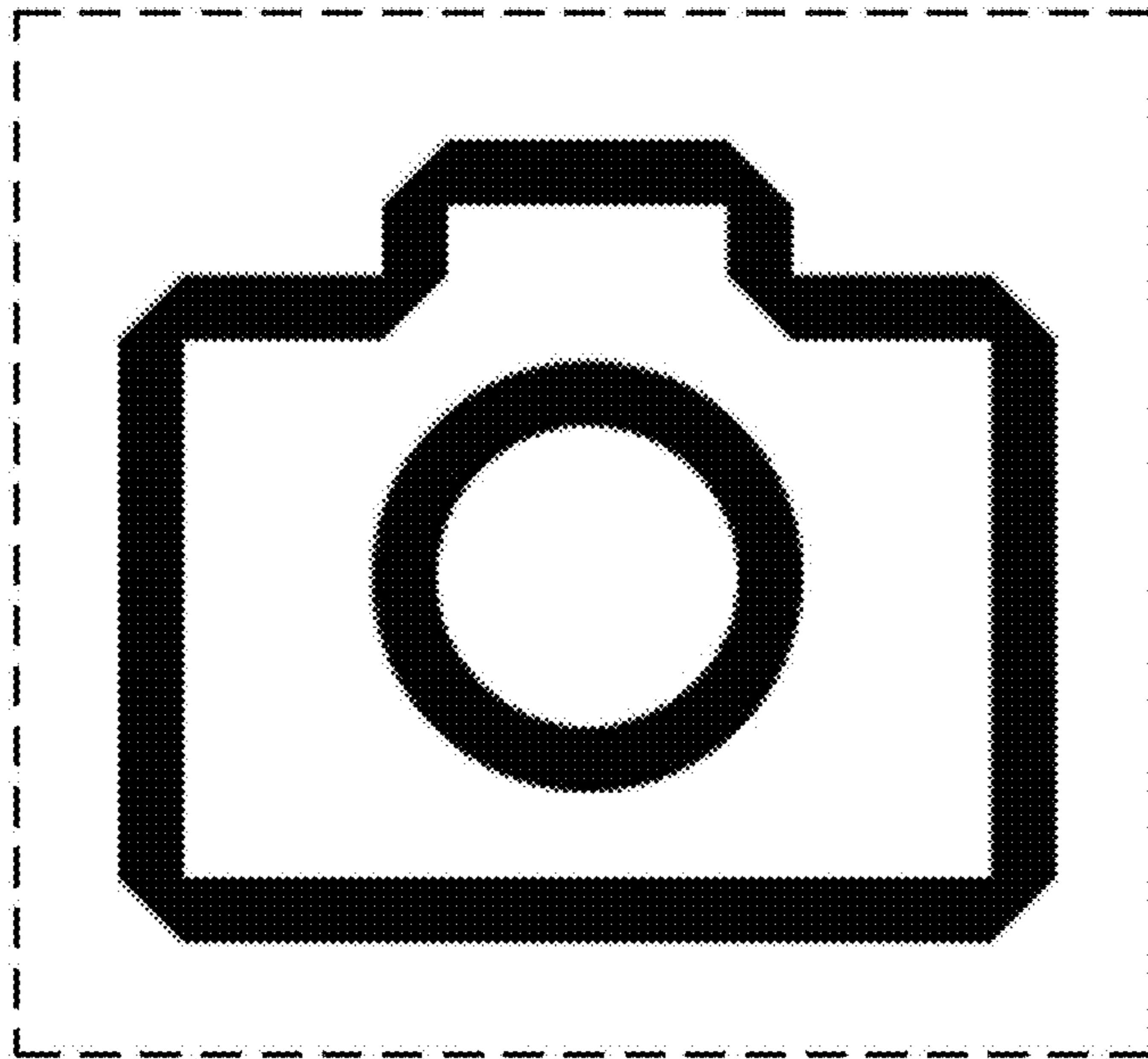

FIG. 2

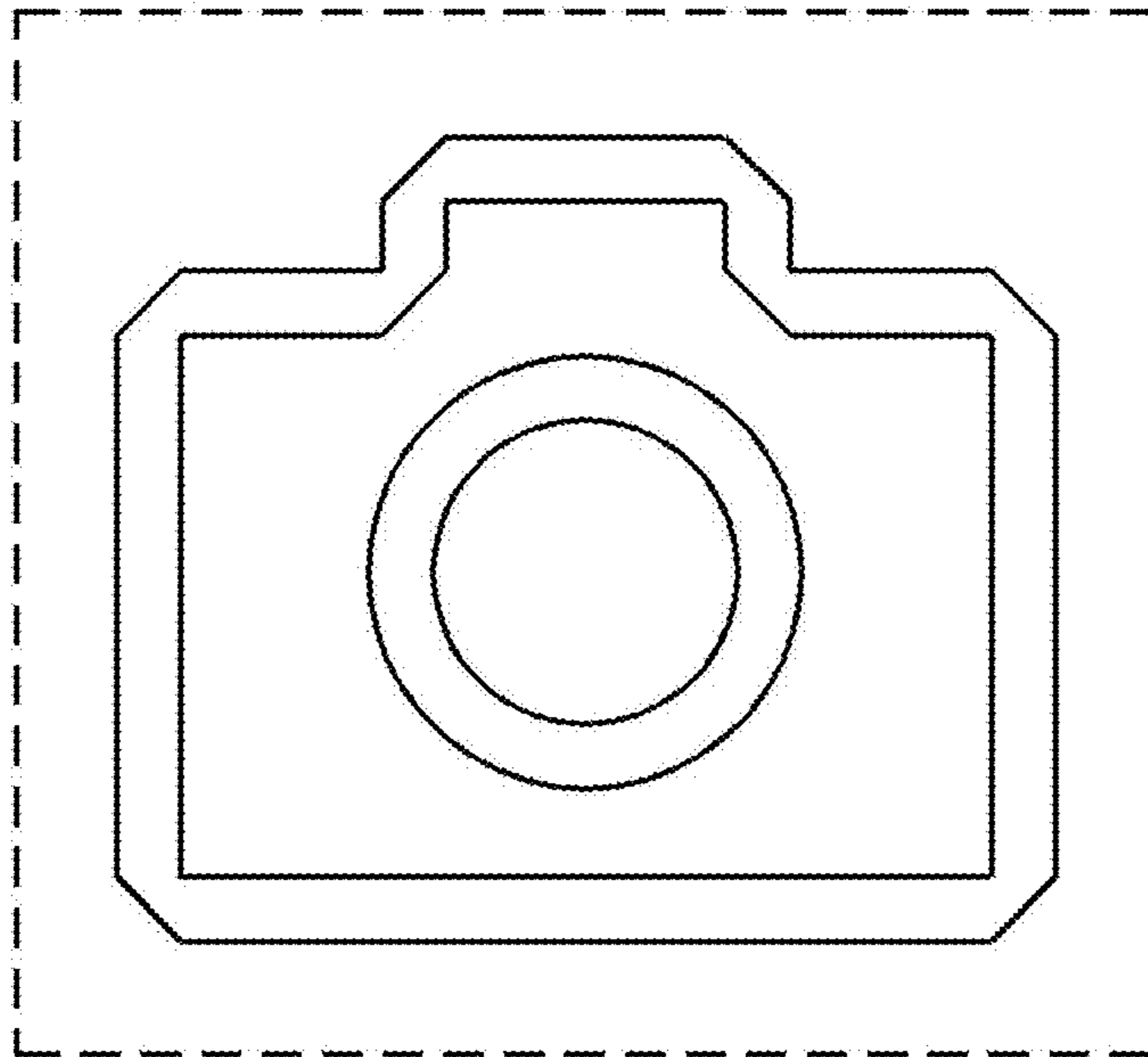

FIG. 3

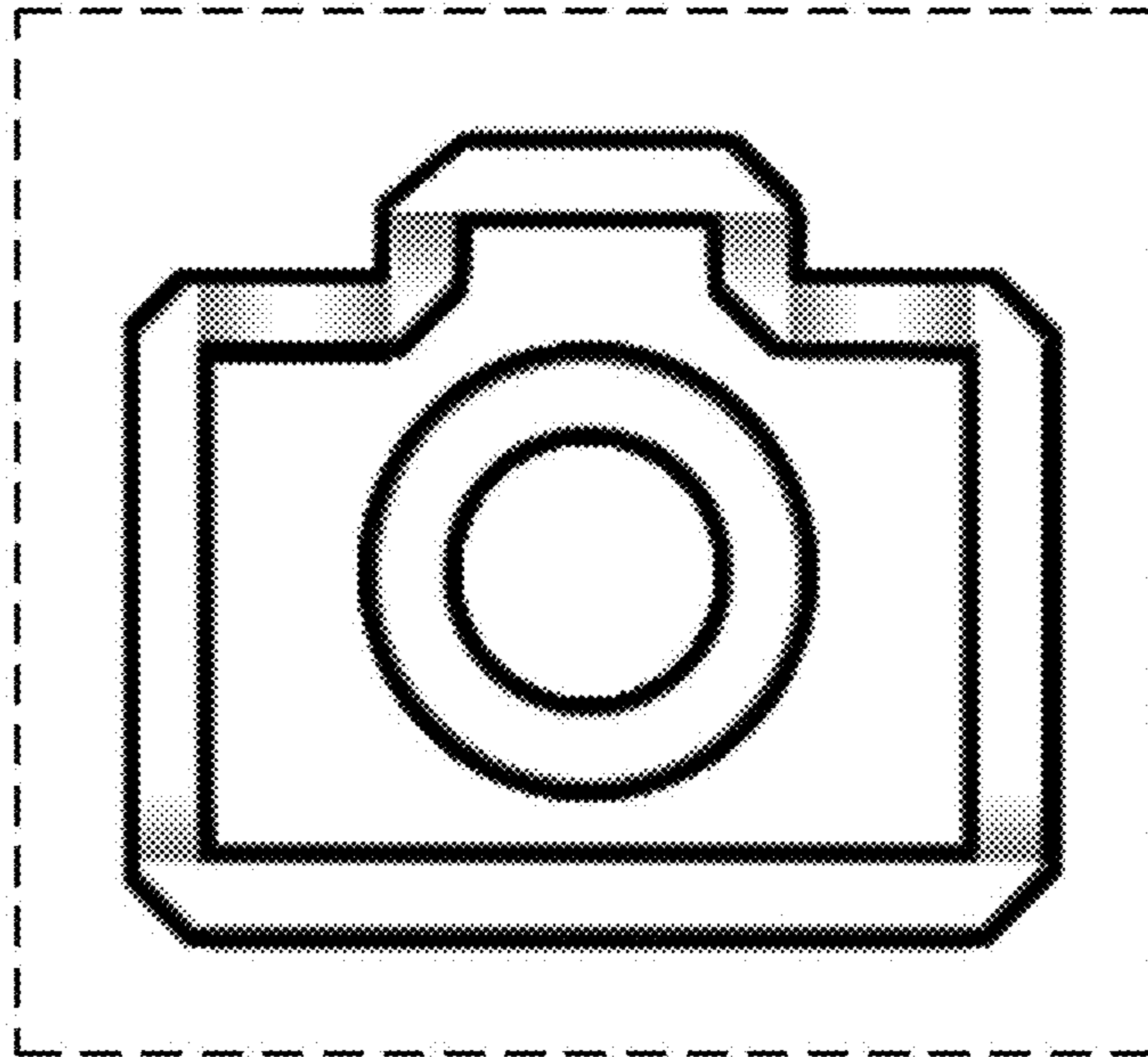

FIG. 4

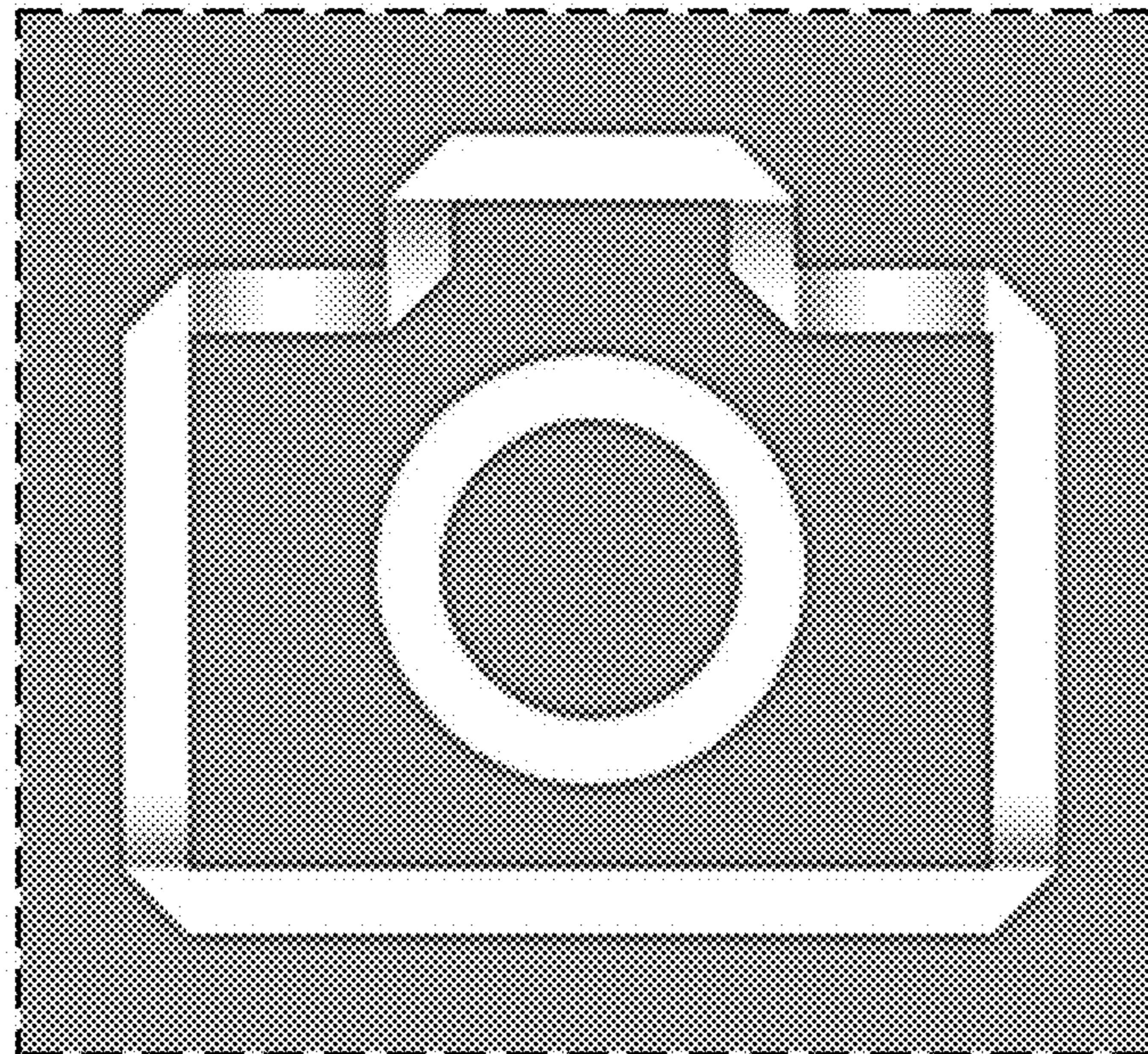

FIG. 5

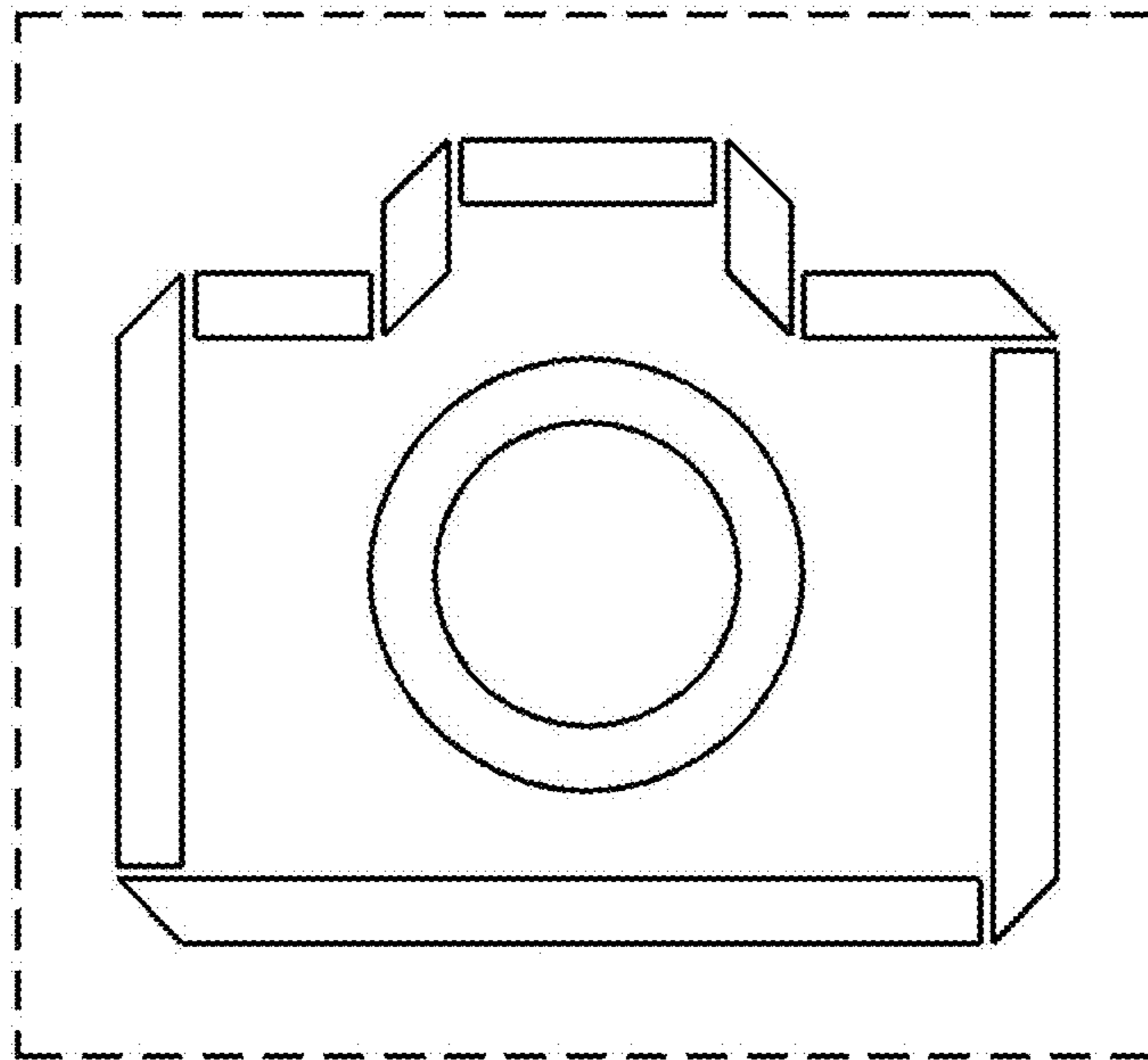

FIG. 6

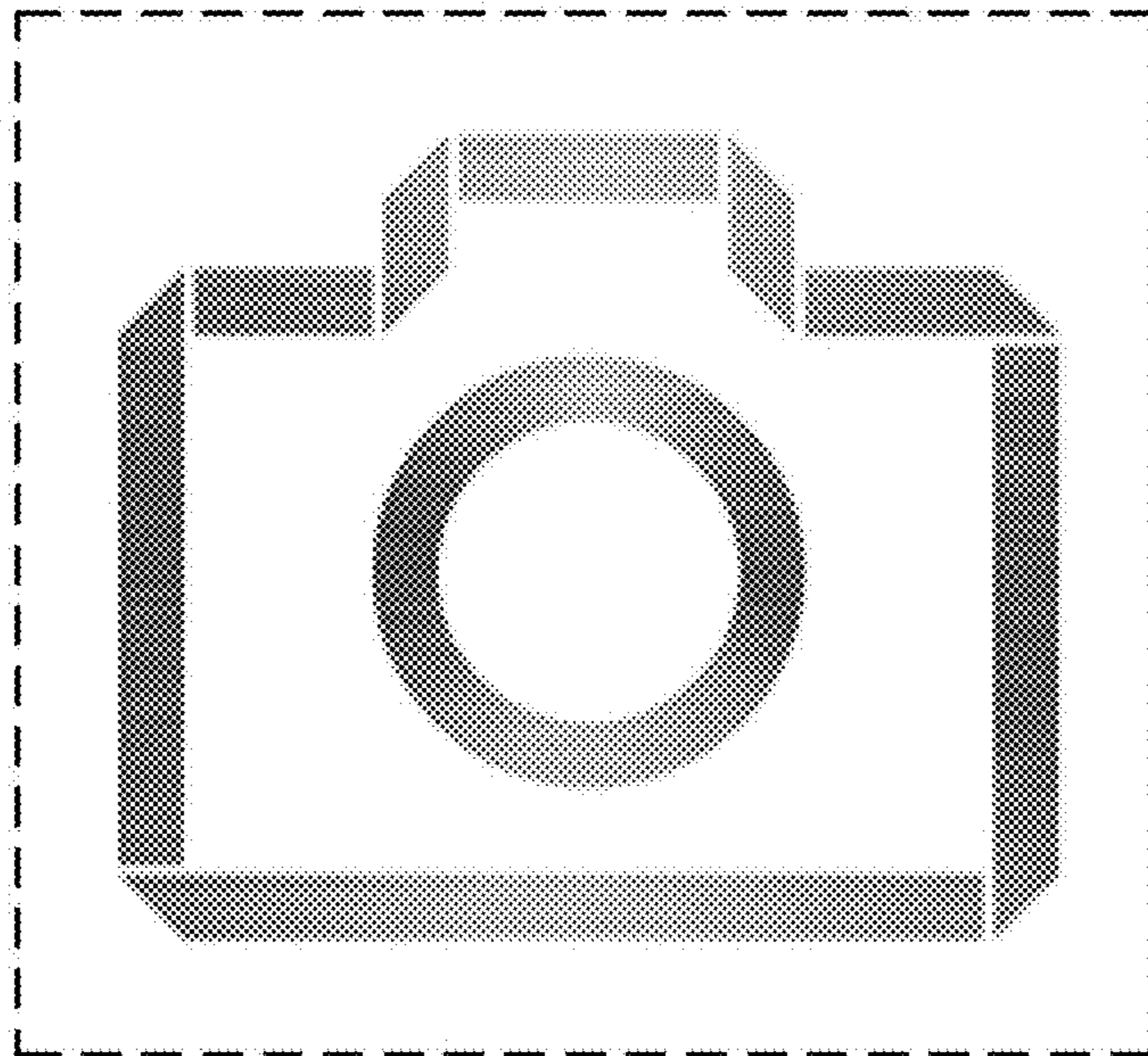

FIG. 7

