



US00D749570S

(12) **United States Design Patent**
Lee

(10) **Patent No.:** **US D749,570 S**
(45) **Date of Patent:** **** Feb. 16, 2016**

(54) **PORTABLE INFORMATION TERMINAL**

(71) Applicant: **Samsung Electronics Co., Ltd,**
Suwon-si, Gyeonggi-do (KR)

(72) Inventor: **Woo-Seok Lee,** Seoul (KR)

(73) Assignee: **SAMSUNG ELECTRONICS CO.,**
LTD. (KR)

(**) Term: **14 Years**

(21) Appl. No.: **29/499,976**

(22) Filed: **Aug. 20, 2014**

(30) **Foreign Application Priority Data**

Feb. 21, 2014 (KR) 30-2014-0008941

(51) **LOC (10) Cl.** **14-02**

(52) **U.S. Cl.**
USPC **D14/344**

(58) **Field of Classification Search**

USPC D14/300–302, 314, 348–370, 383–385,
D14/435, 496, 125, 135, 155, 240–242, 299,
D14/344; D11/1–39, 86–87, 93–94,
D11/200–201; D13/103, 119, 162, 184,
D13/199; D10/65, 75, 78; D9/432; D3/273
CPC H04M 1/0227; H04M 1/03; H04M 1/04;
G04G 9/00; G04G 17/00; G04G 17/04;
G04G 17/06; G01S 19/34; H01Q 1/273

See application file for complete search history.

(56) **References Cited**

U.S. PATENT DOCUMENTS

D594,875 S * 6/2009 Sheba D14/203.3
D613,737 S * 4/2010 Ahlstrom D14/344
D629,012 S * 12/2010 Lee D14/203.7
D645,360 S * 9/2011 Kiser D10/32
D648,298 S * 11/2011 Pierce D14/138 G
D648,689 S * 11/2011 Mehlsen D14/125

D692,784 S * 11/2013 Anderssen D10/106.92
D693,251 S * 11/2013 Anderssen D10/65
D705,201 S * 5/2014 Isaacs D14/240
D705,748 S * 5/2014 He D14/155
D710,824 S * 8/2014 Mackiewicz D14/214
D719,153 S * 12/2014 Lim D14/356
D726,680 S * 4/2015 Kim D10/37
D727,360 S * 4/2015 Peng D14/203.1
D729,681 S * 5/2015 Lee D11/3
D732,512 S * 6/2015 Fariello D14/230
D736,652 S * 8/2015 Isaacs D10/32
D738,878 S * 9/2015 Lee D10/104.2

* cited by examiner

Primary Examiner — Karen E Kearney

Assistant Examiner — Nathaniel D Buckner

(74) *Attorney, Agent, or Firm* — Cantor Colburn LLP

(57) **CLAIM**

The ornamental design for a portable information terminal, as shown and described.

DESCRIPTION

FIG. 1 is a perspective view of a portable information terminal, showing my new design;
FIG. 2 is a front view thereof;
FIG. 3 is a rear view thereof;
FIG. 4 is a side view thereof;
FIG. 5 is another side view thereof;
FIG. 6 is a top view thereof;
FIG. 7 is a bottom view thereof;
FIG. 8 is another perspective view thereof as shown in a user environment; and,
FIG. 9 is another perspective view thereof as shown in another user environment.

The broken lines in the figures represent portions of the article which form no part of the claim. The broken lines showing of the strap and clip in FIGS. 8 and 9 are included for the purpose of illustrating environmental structure and form no part of the claimed design.

1 Claim, 9 Drawing Sheets

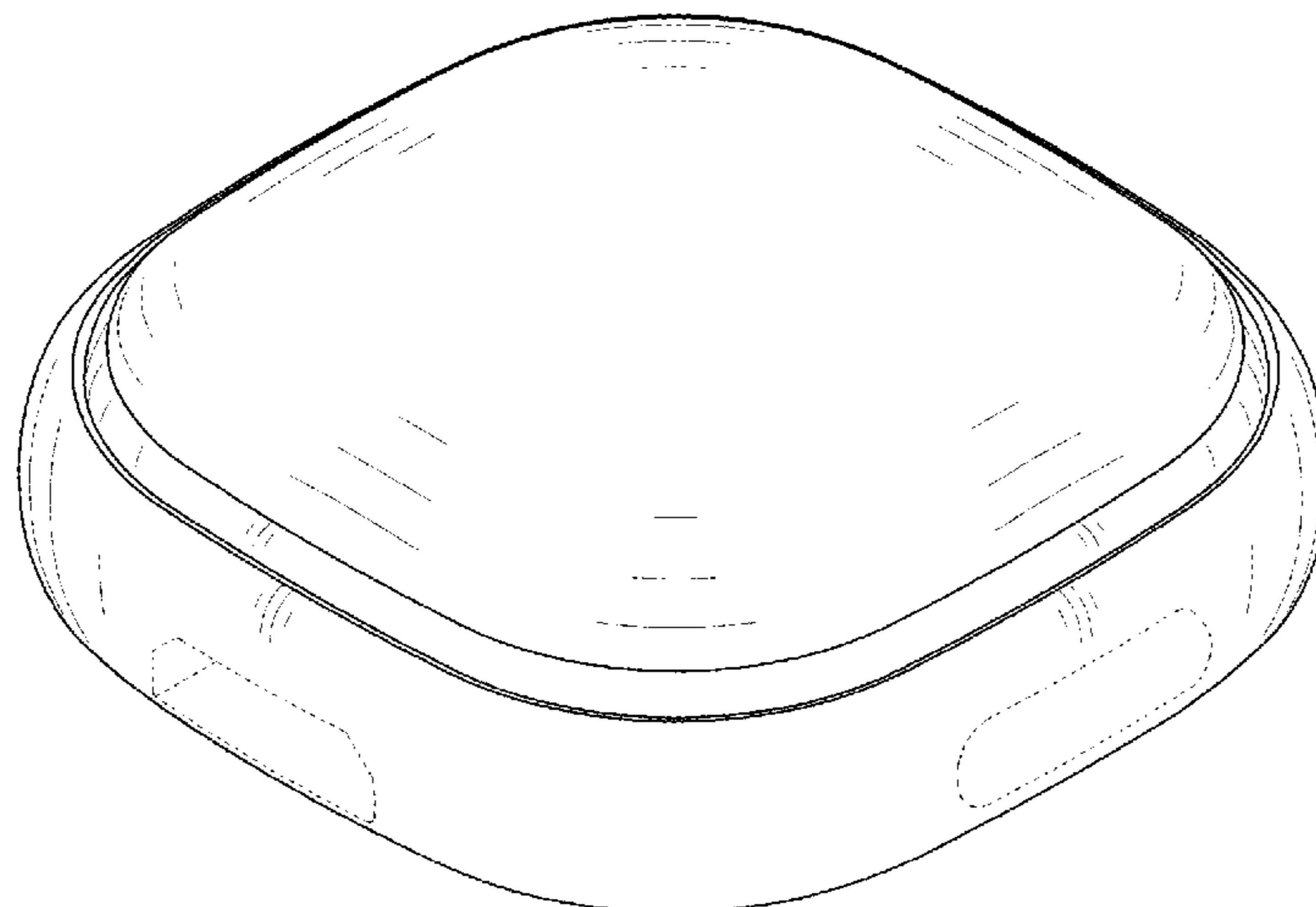

FIG. 1

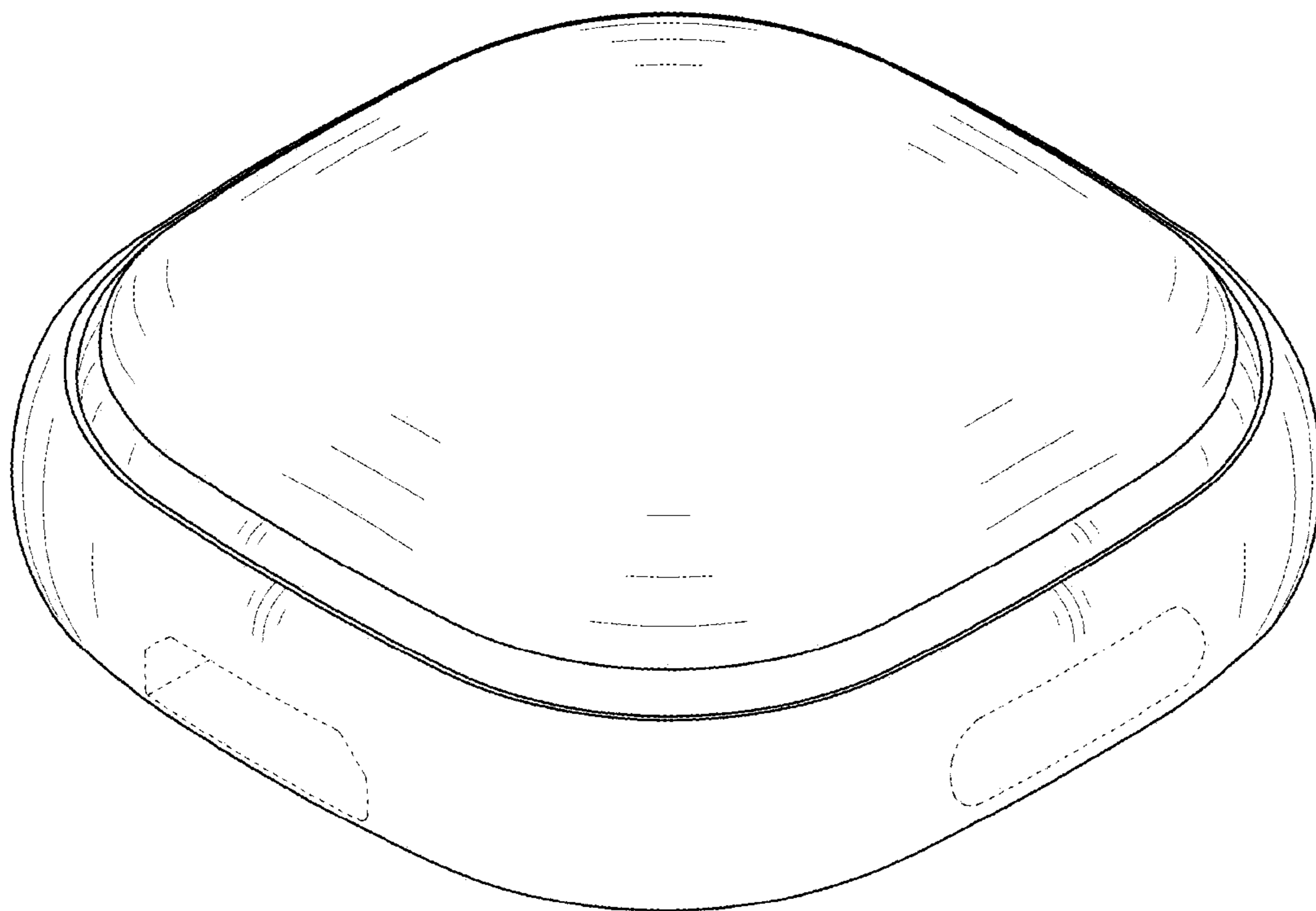

FIG. 2

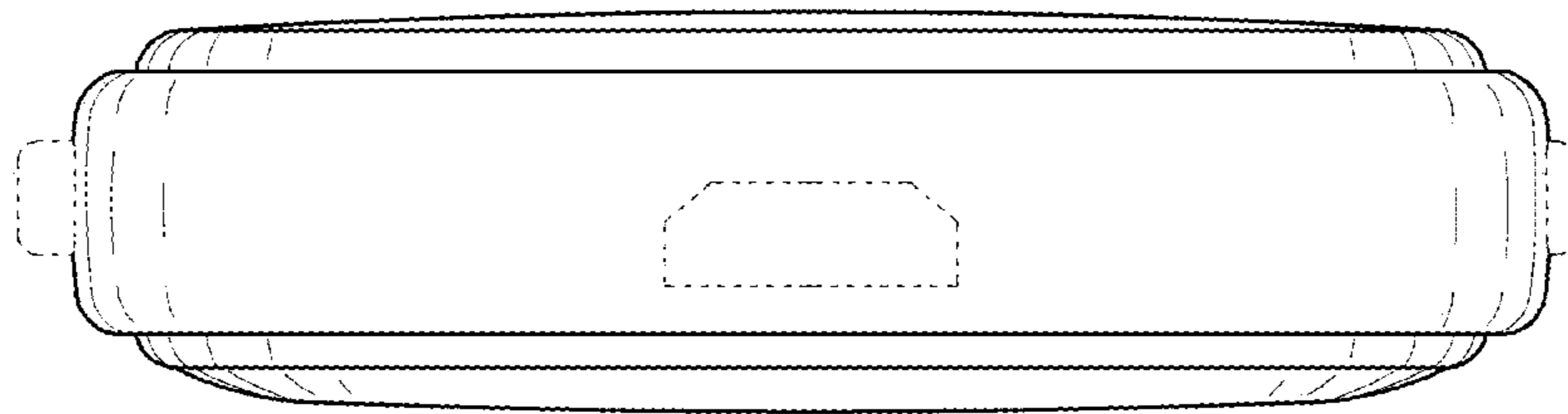

FIG. 3

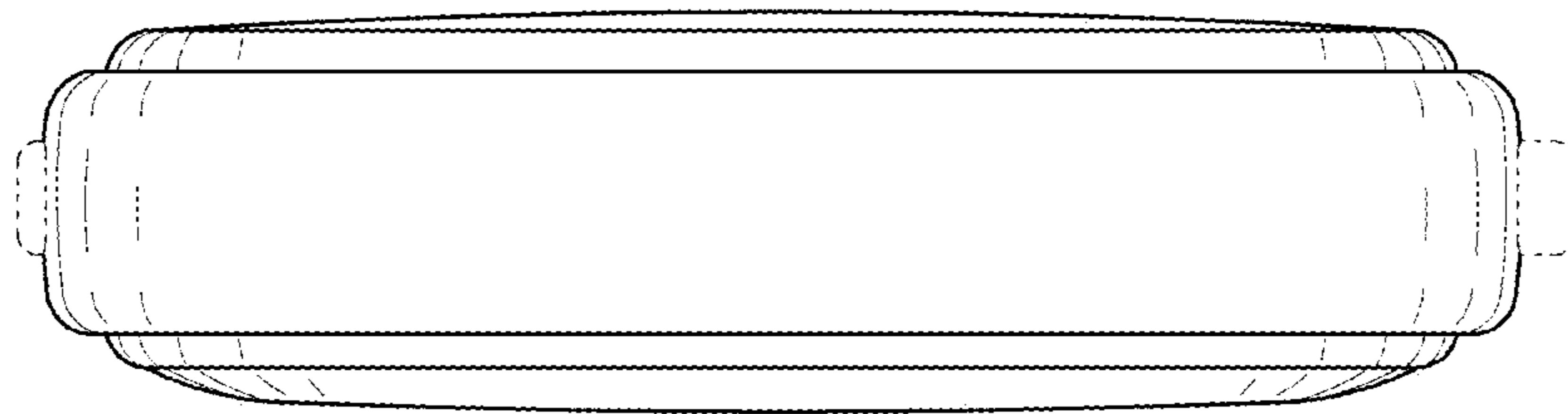

FIG. 4

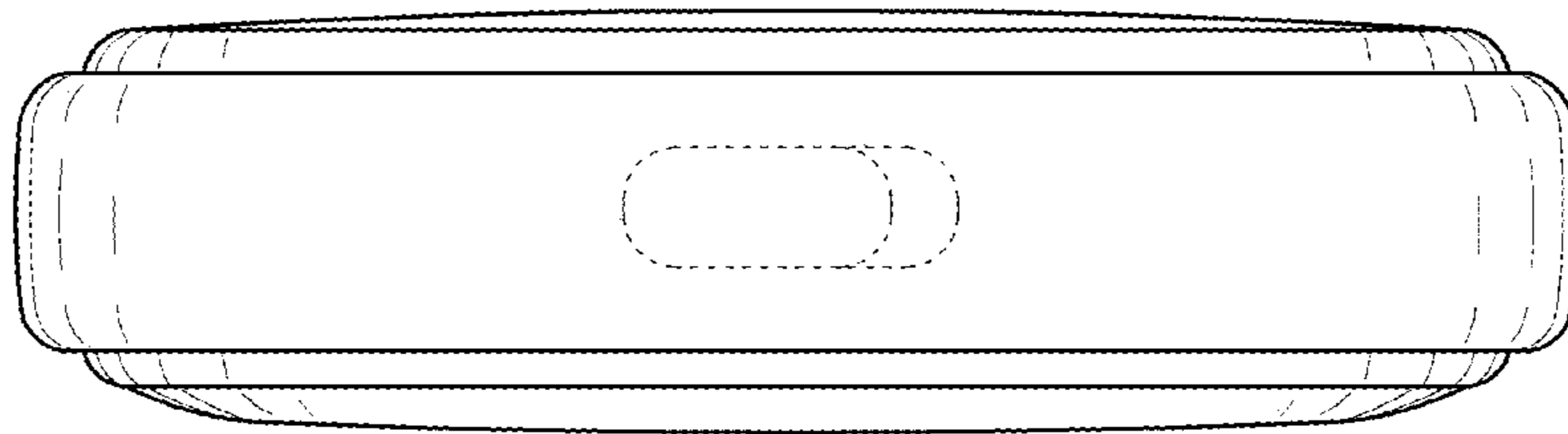

FIG. 5

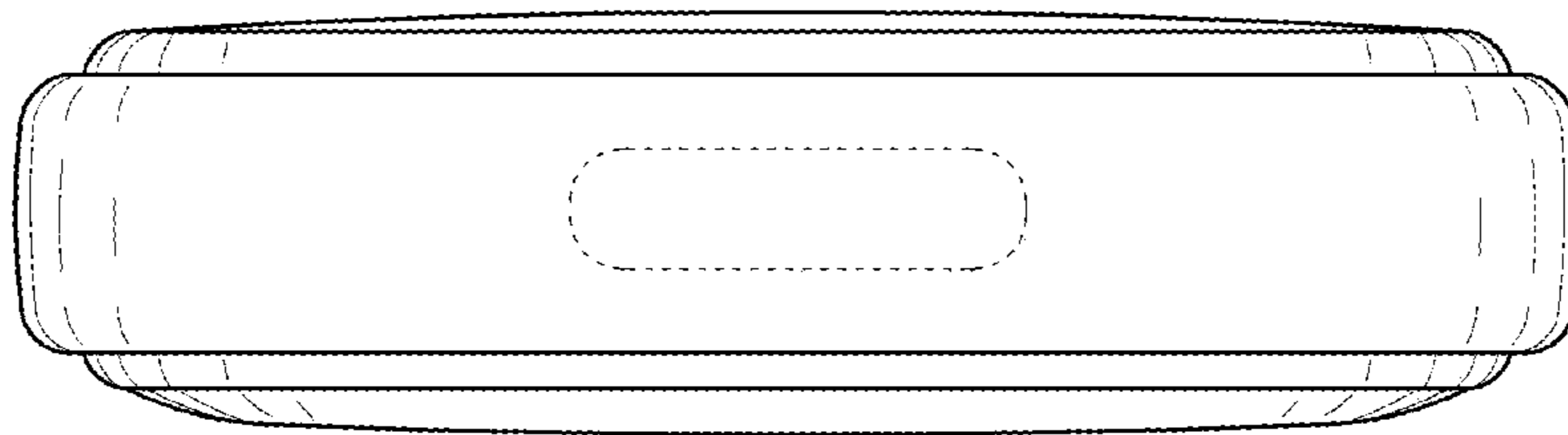

FIG. 6

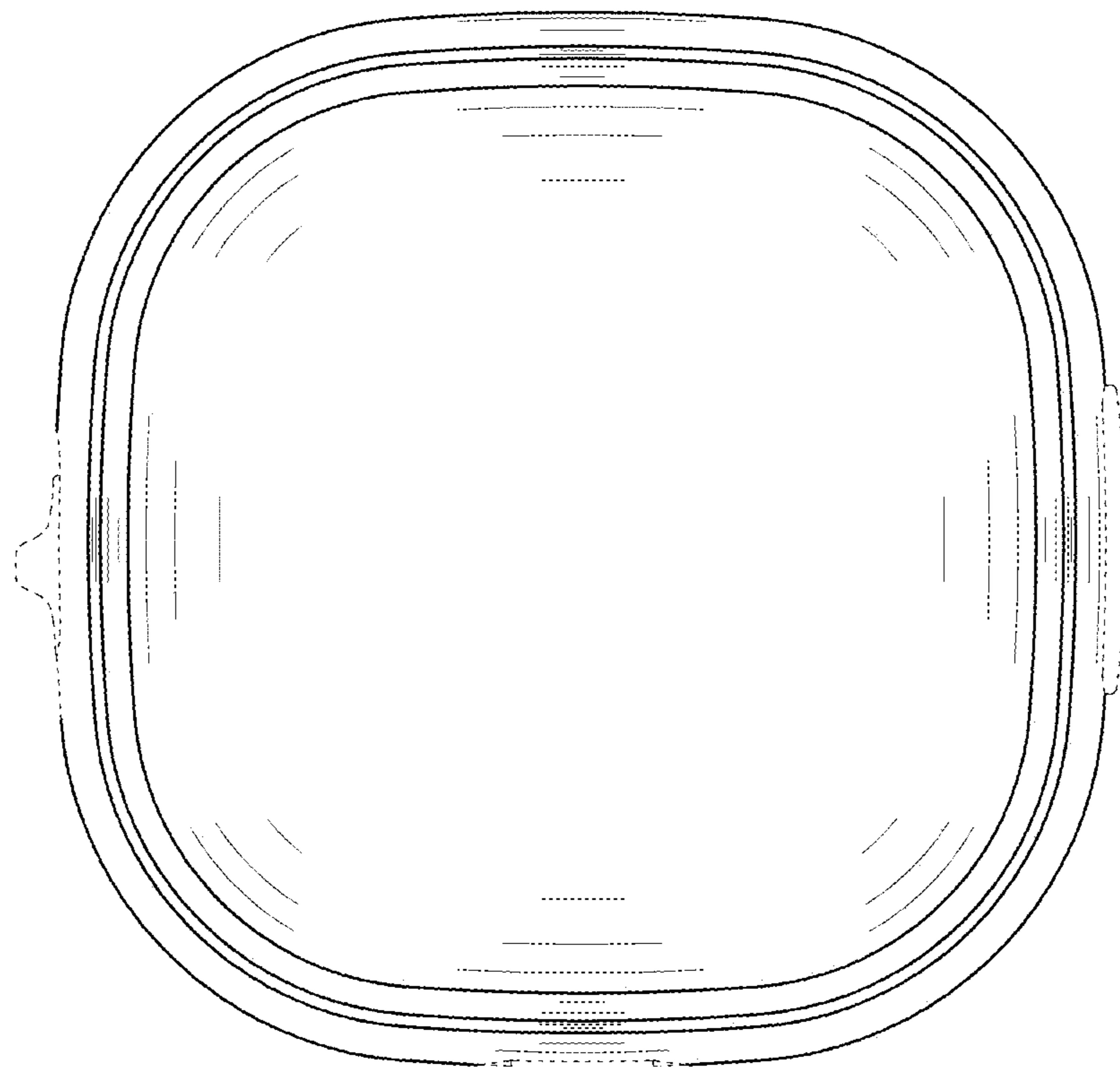

FIG. 7

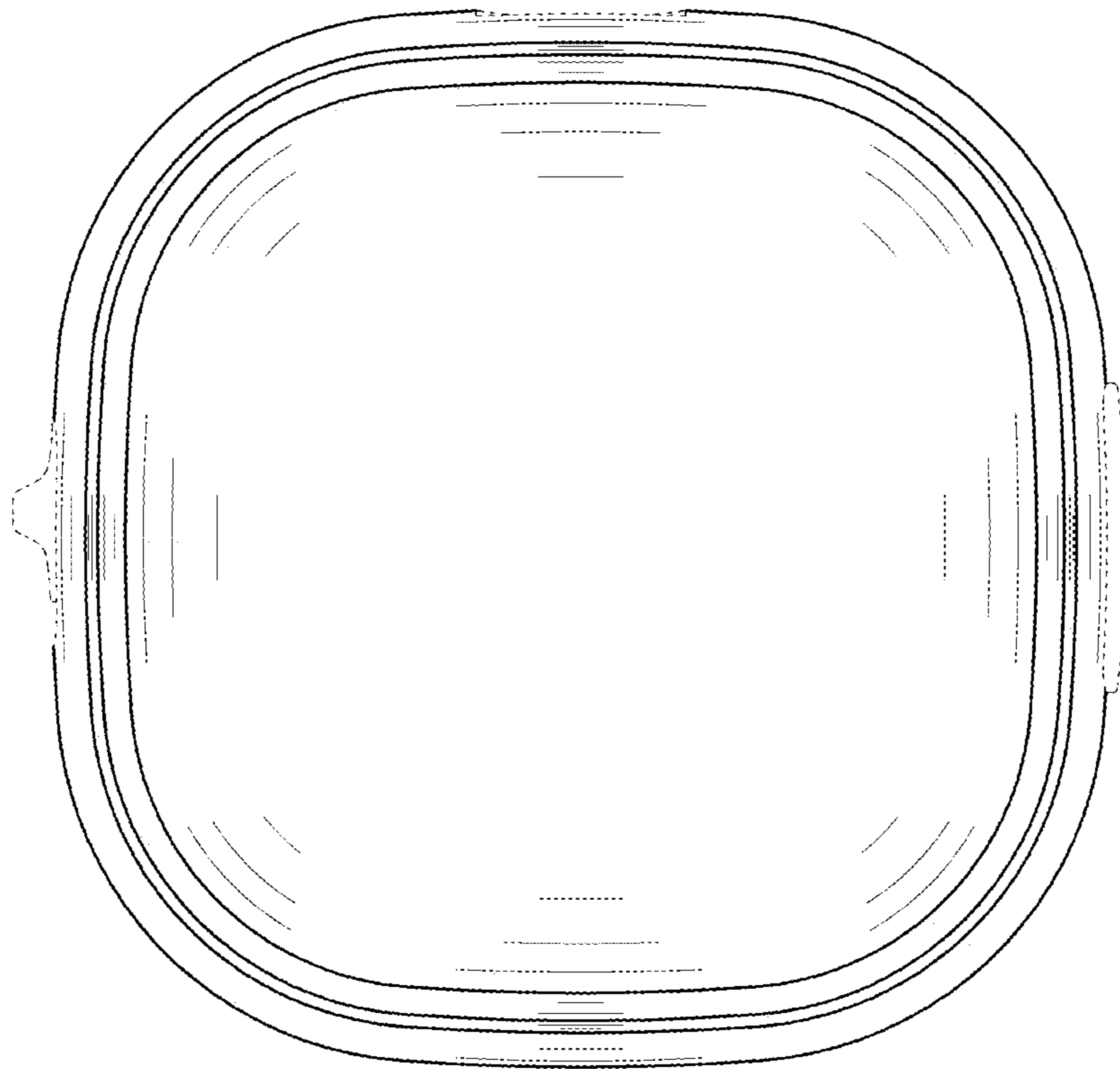

FIG. 8

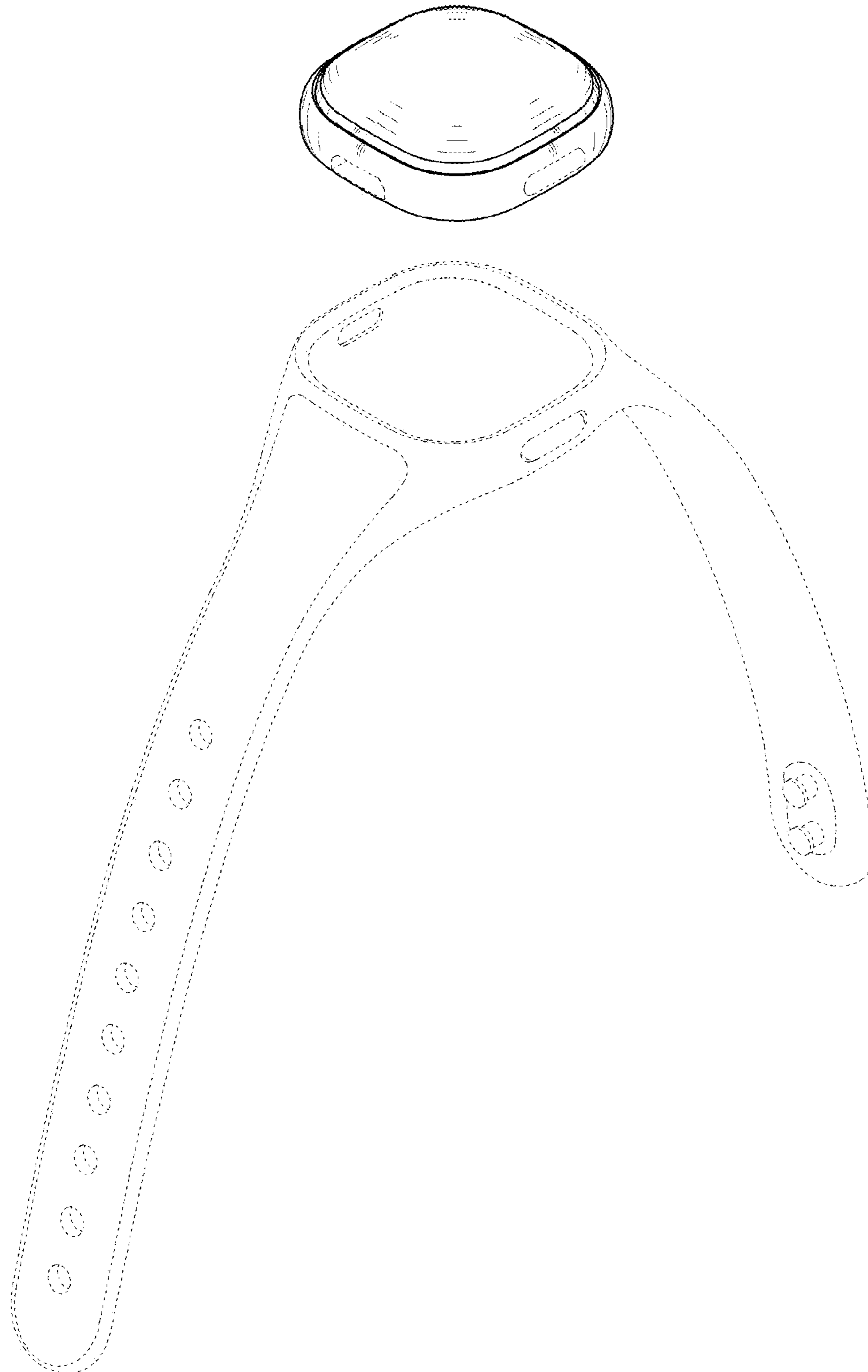

FIG. 9

