



US00D749557S

(12) **United States Design Patent**
Feng

(10) **Patent No.:** **US D749,557 S**
(45) **Date of Patent:** **** Feb. 16, 2016**

(54) **MOBILE PHONE CASE**
(71) Applicant: **Guangzhen Feng**, Dazhou (CN)
(72) Inventor: **Guangzhen Feng**, Dazhou (CN)
(**) Term: **14 Years**
(21) Appl. No.: **29/512,788**
(22) Filed: **Dec. 23, 2014**
(51) **LOC (10) Cl.** **14-03**
(52) **U.S. Cl.**
USPC **D14/250**
(58) **Field of Classification Search**
USPC D14/250, 341, 486, 252, 248, 217, 251,
D14/496, 253, 138 AD, 138 G, 346, 138 C,
D14/138 R, 138 AA, 202; D3/218, 203.2,
D3/201; D13/108, 103; 446/72; 455/559,
455/575.8, 556.1, 575.1, 90.3, 128; 439/39,
439/660; 361/679.56, 679.3, 679.55,
361/679.57; 312/223.1, 351.1; 248/689,
248/351, 465; 206/320, 37, 45.24, 316.2,
206/701, 811; 264/328.1; 29/428; 345/173;
220/212, 560, 622, 692, 782, 784, 788;
292/294, 301, DIG. 47
CPC Y10T 29/49826; A45C 11/00; A45C
2011/002; H04B 1/3888; G06F 1/1626
See application file for complete search history.

8,522,965 B1 * 9/2013 Hsiung B65D 25/24
206/320
D700,598 S * 3/2014 Kim D14/250
8,681,491 B1 * 3/2014 Cruz H04M 1/04
248/351
D706,254 S * 6/2014 Chang D14/217
D706,255 S * 6/2014 Akana D14/250

(Continued)

Primary Examiner — Robert M Spear
Assistant Examiner — Ryan Harvey

(57) **CLAIM**

The ornamental design for a mobile phone case, as shown and described.

DESCRIPTION

FIG. 1 is a first perspective view of a mobile phone case showing my new design;
FIG. 2 is a second perspective view thereof;
FIG. 3 is a third perspective view thereof;
FIG. 4 is a fourth perspective view thereof;
FIG. 5 is a fifth perspective view thereof;
FIG. 6 is a sixth perspective view thereof;
FIG. 7 is a seventh perspective view thereof, showing the mobile phone case in an open position;
FIG. 8 is an eighth perspective view thereof, showing the mobile phone case in an open position;
FIG. 9 is a ninth perspective view thereof, showing the mobile phone case in an open position;
FIG. 10 is a tenth perspective view thereof, showing the mobile phone case in an open position;
FIG. 11 is an eleventh perspective view thereof, showing the mobile phone case in an open position;
FIG. 12 is a twelfth perspective view thereof, showing the mobile phone case in an open position;
FIG. 13 is a thirteenth perspective view thereof, showing the mobile phone case in an open position;
FIG. 14 is a first side view thereof, showing the mobile phone case in an open position; and,
FIG. 15 is a second side view thereof, showing the mobile phone case in an open position.

1 Claim, 15 Drawing Sheets

(56) **References Cited**

U.S. PATENT DOCUMENTS

D312,534 S * 12/1990 Nelson D10/80
D615,078 S * 5/2010 Bradley D14/250
D619,130 S * 7/2010 Fellig D14/250
D624,064 S * 9/2010 Esposito D14/250
D626,119 S * 10/2010 Fellig D14/250
D644,218 S * 8/2011 Akana D14/250
D655,281 S * 3/2012 Turocy D14/250
D663,294 S * 7/2012 Buxton D14/250
D669,458 S * 10/2012 Wilson D14/250
D671,930 S * 12/2012 Akana D14/250
D679,271 S * 4/2013 Liu D13/103

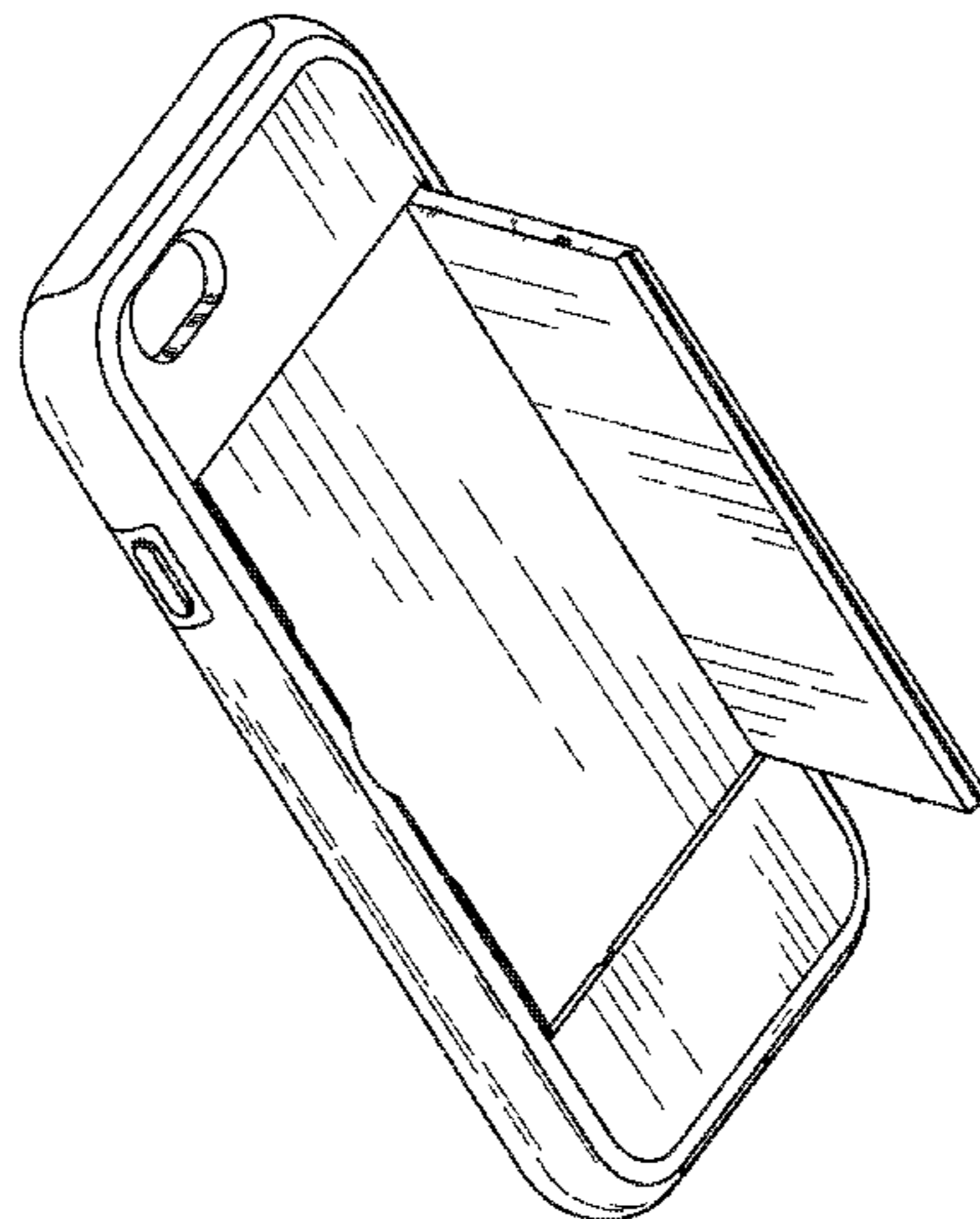

(56)

References Cited

U.S. PATENT DOCUMENTS

D712,890 S *	9/2014	McCormac	D14/250	2013/0098790 A1*	4/2013	Hong	A45C 11/00 206/320
D717,286 S *	11/2014	Veldkamp	D14/250	2013/0257240 A1*	10/2013	Hong	H04B 1/3888 312/223.1
D717,777 S *	11/2014	Hemesath	D14/250	2014/0051488 A1*	2/2014	Chung	H04M 1/0279 455/575.8
D717,778 S *	11/2014	Zermeno	D14/250	2014/0110275 A1*	4/2014	Wu	A45C 11/00 206/37
D718,291 S *	11/2014	Hong	D14/250	2014/0262855 A1*	9/2014	Gandhi	A45C 11/00 206/45.24
D718,292 S *	11/2014	Hemesath	D14/250	2015/0068935 A1*	3/2015	Kay	A45C 13/36 206/320
D719,559 S *	12/2014	Dukerschein	D14/250	2015/0194994 A1*	7/2015	Soriano	H04B 1/3888 455/575.8
D725,643 S *	3/2015	Lee	D14/250	2015/0194995 A1*	7/2015	Fathollahi	H04B 1/3888 455/575.8
D727,884 S *	4/2015	Fathollahi	D14/250					
D730,344 S *	5/2015	Hemesath	D14/250					
D737,263 S *	8/2015	Armstrong	D14/250					
2009/0017883 A1*	1/2009	Lin	A45C 11/00 455/575.8					
2012/0103844 A1*	5/2012	Piedra	206/320					

* cited by examiner

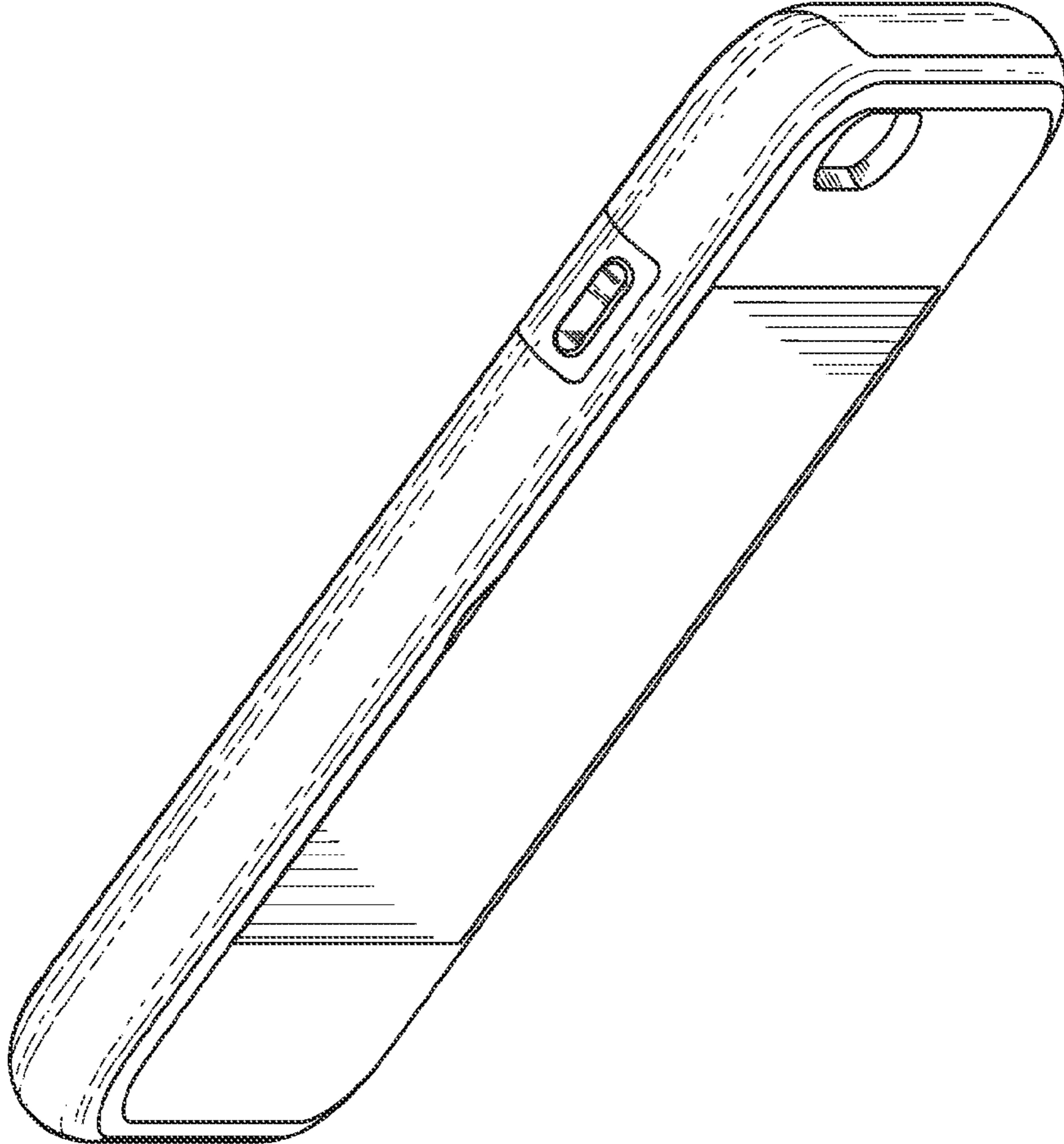

FIG. 1

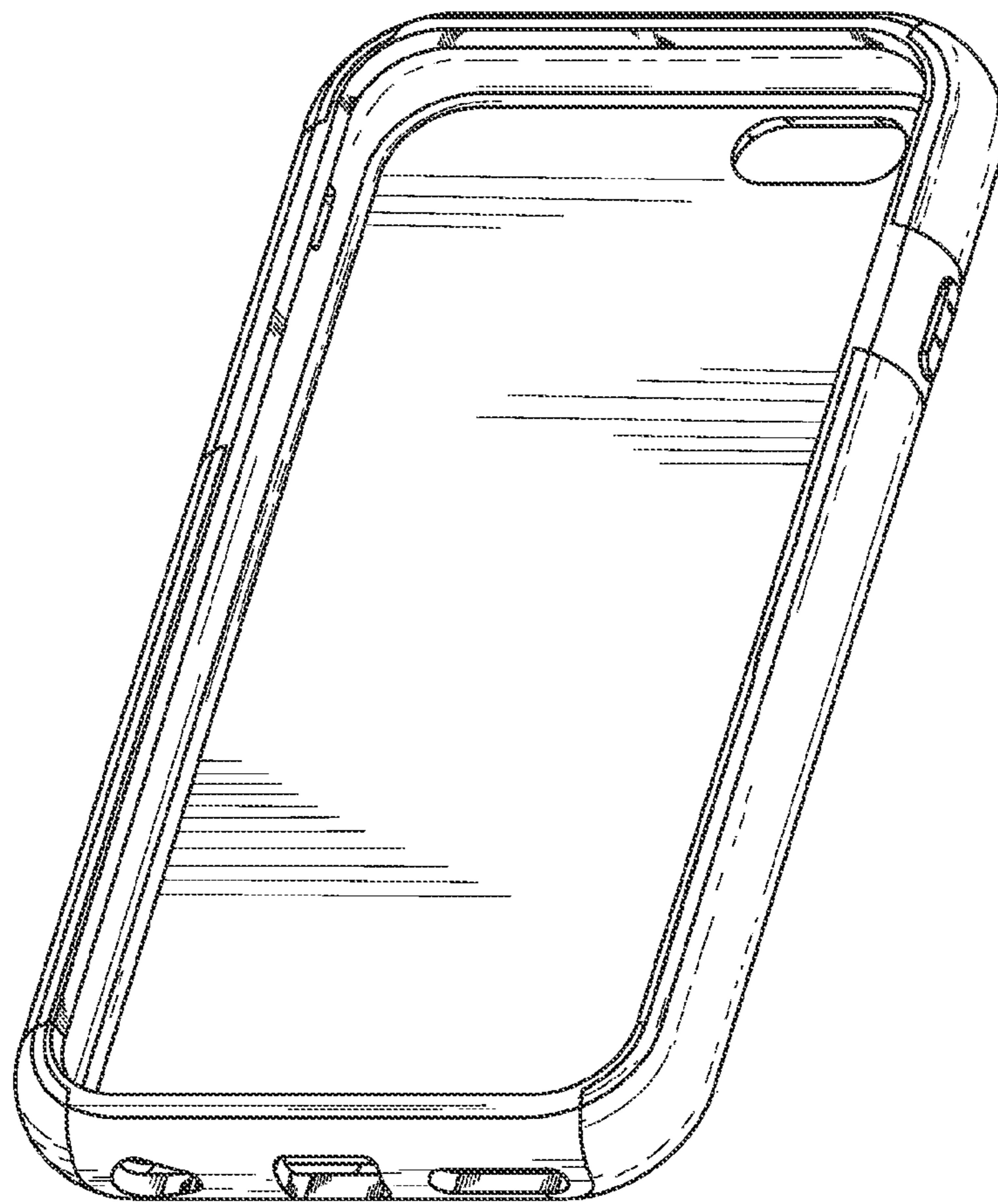

FIG. 2

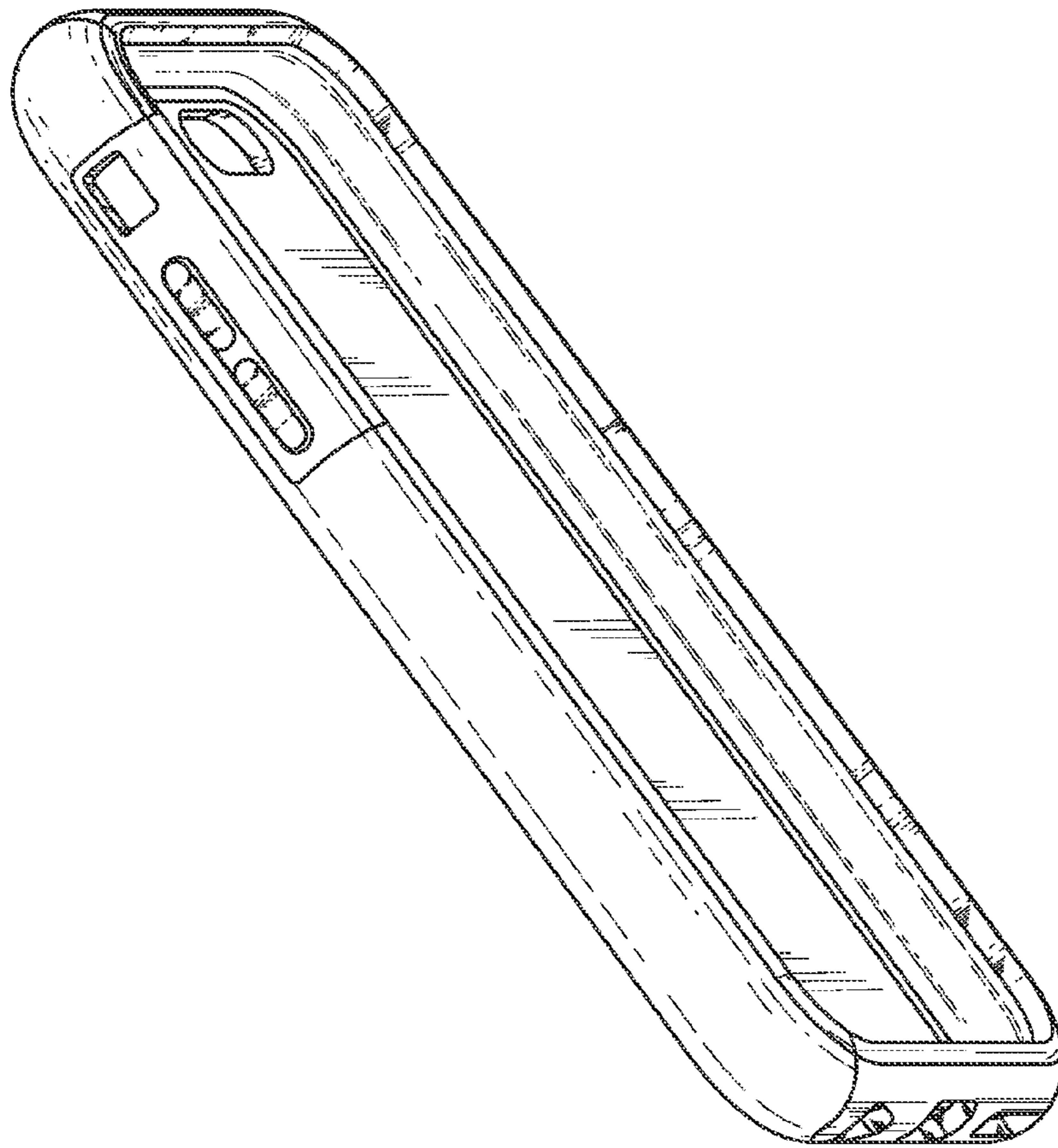

FIG. 3

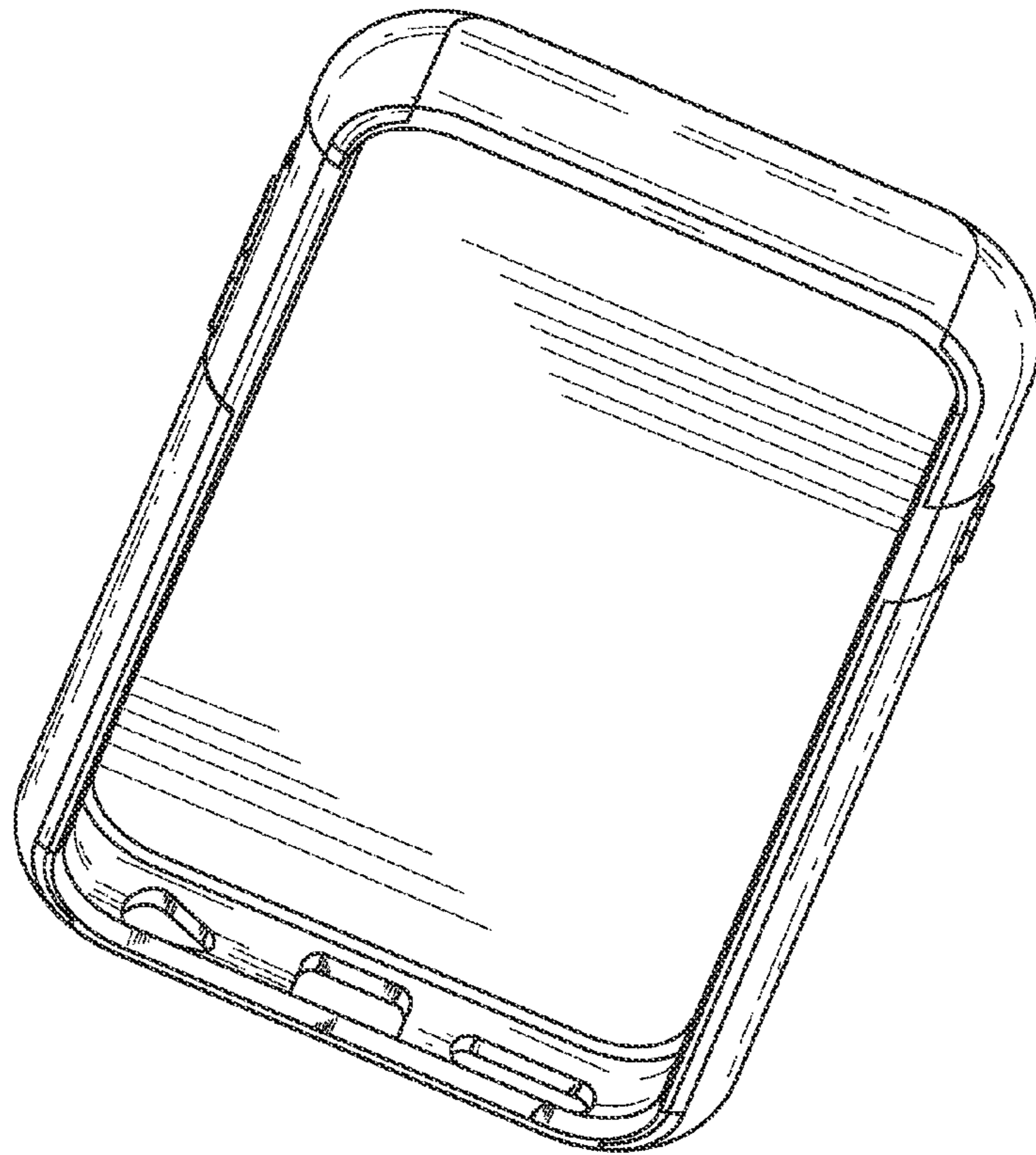

FIG. 4

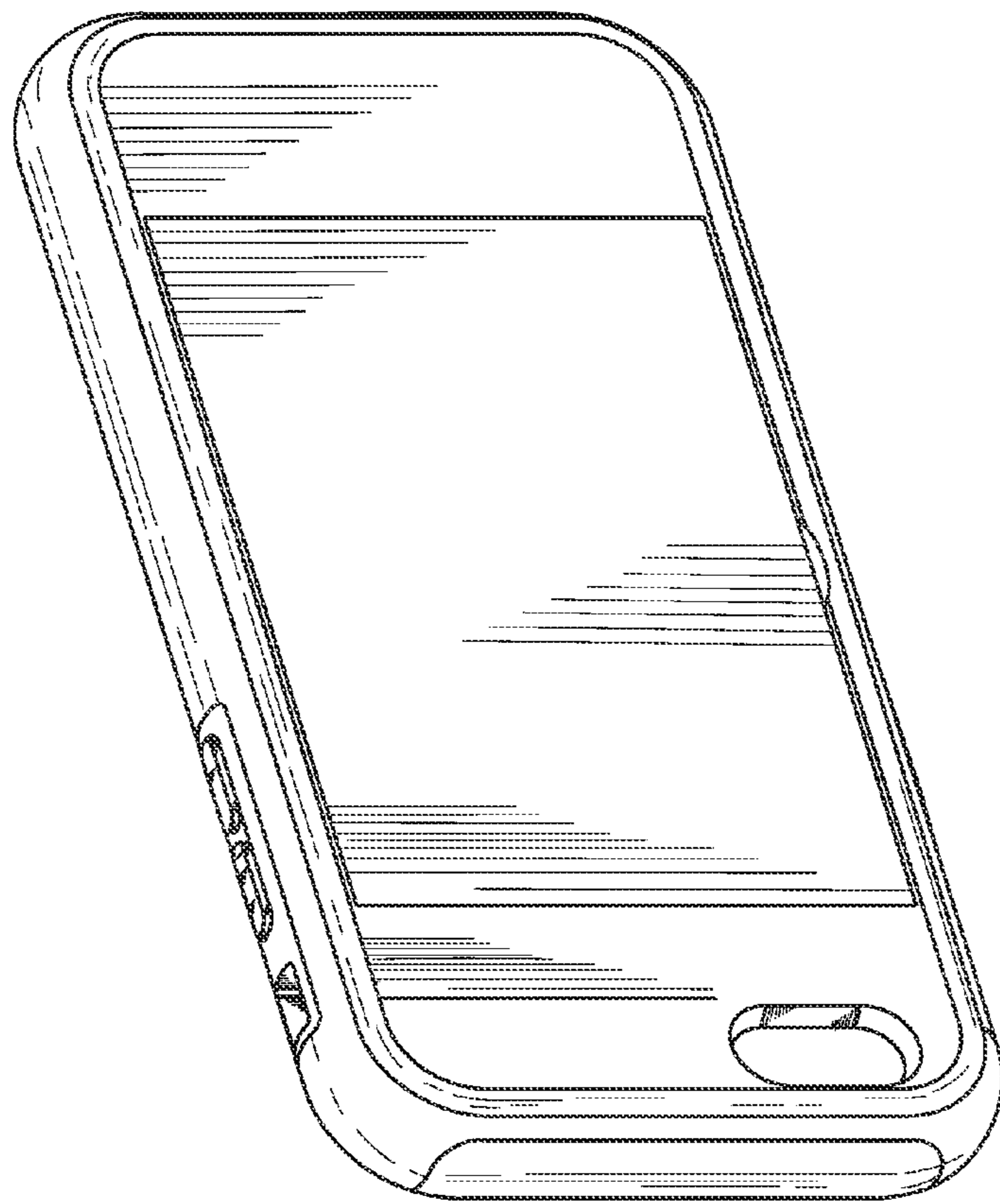

FIG. 5

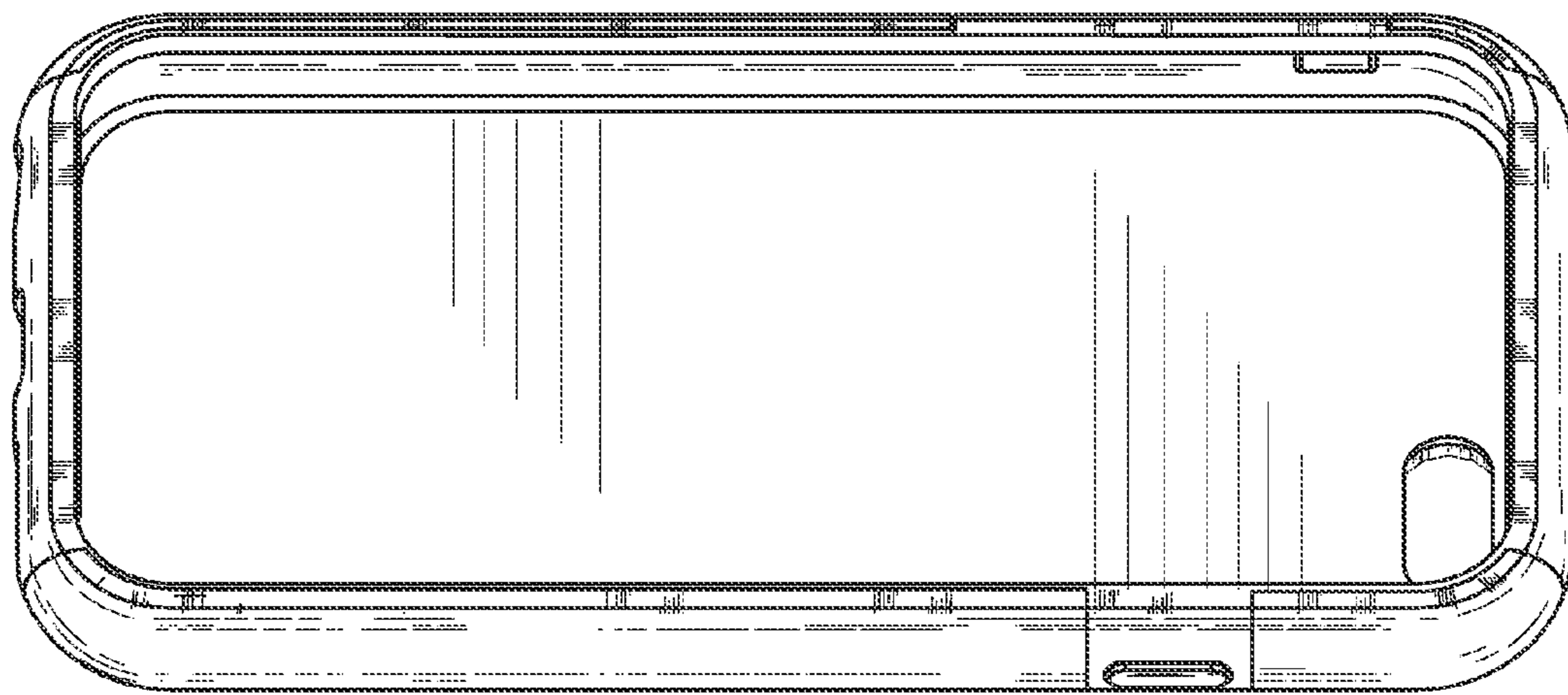

FIG. 6

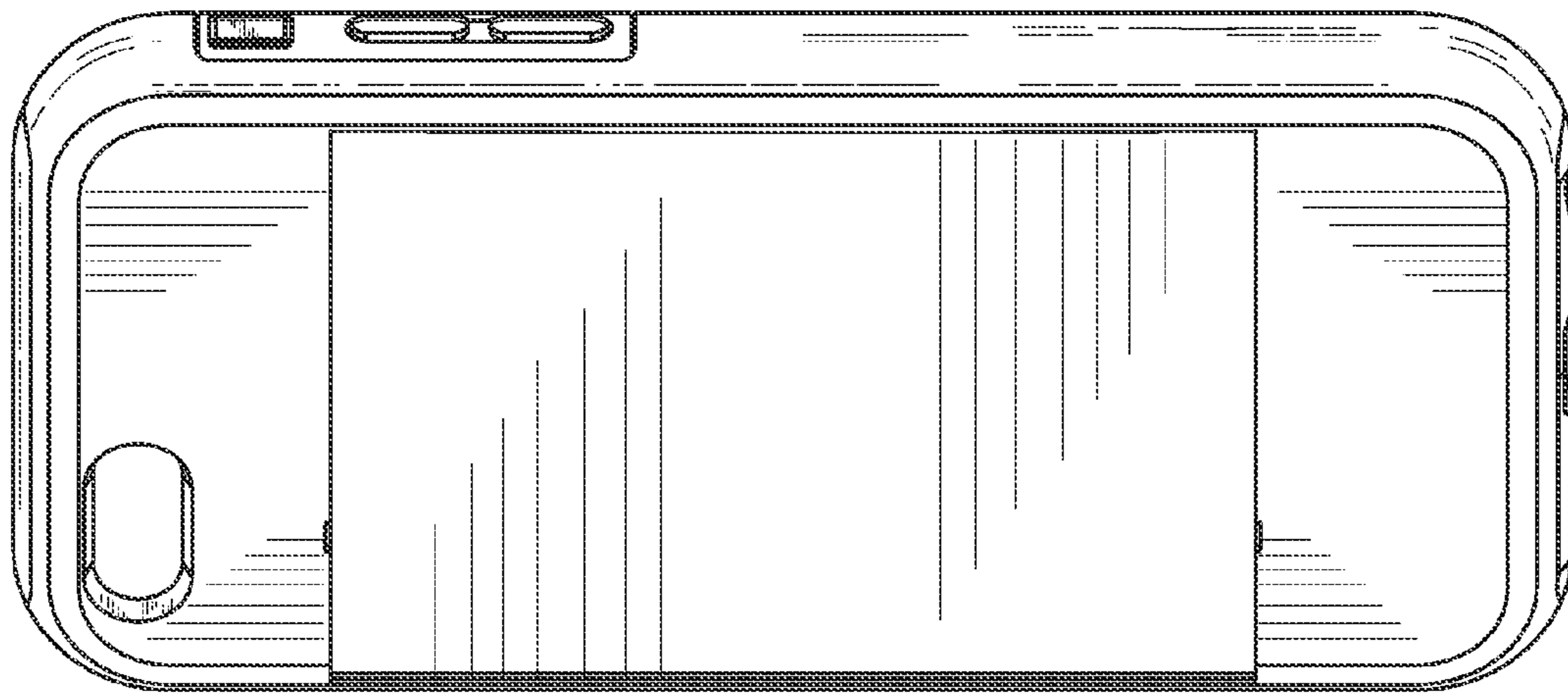

FIG. 7

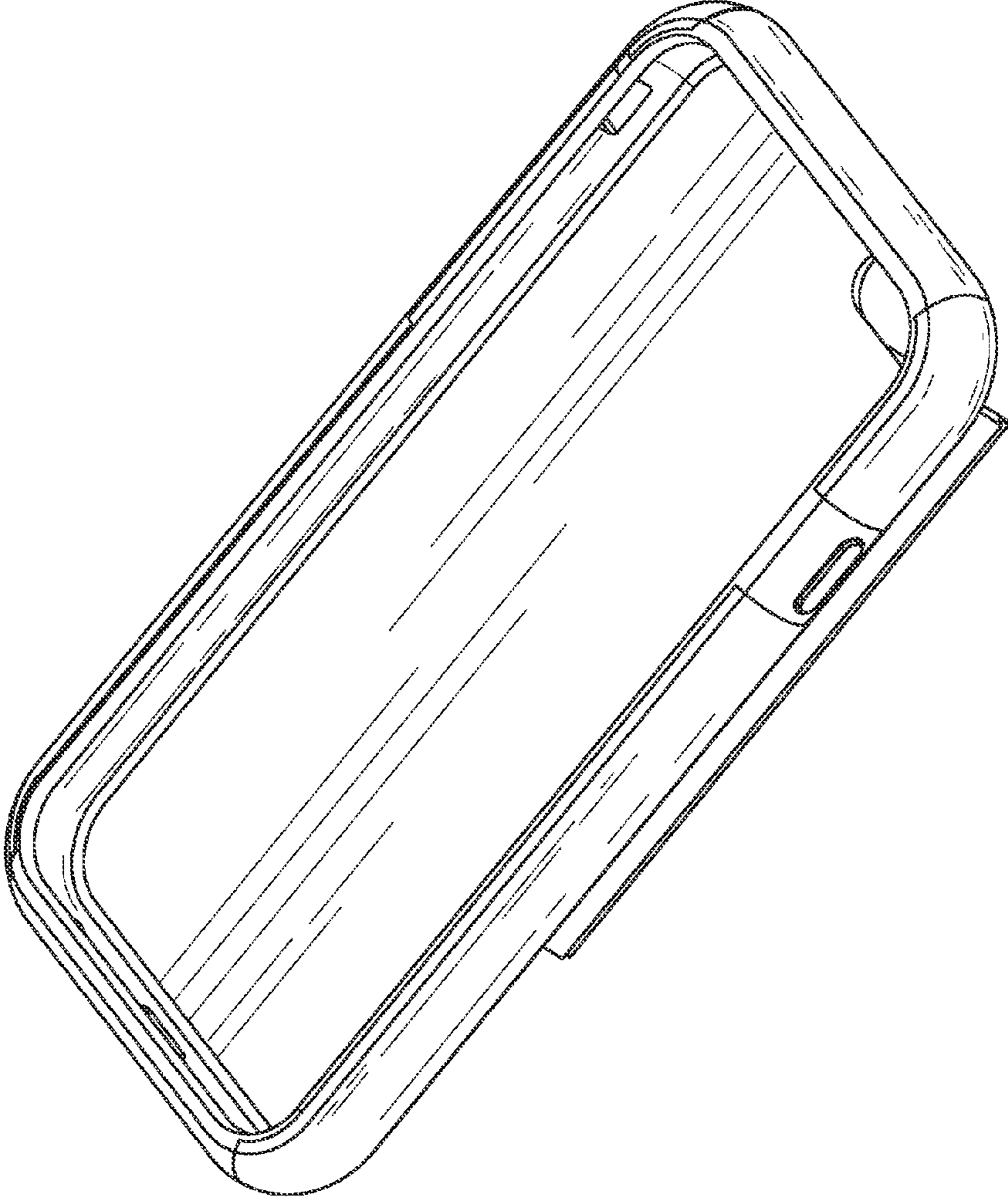

FIG. 8

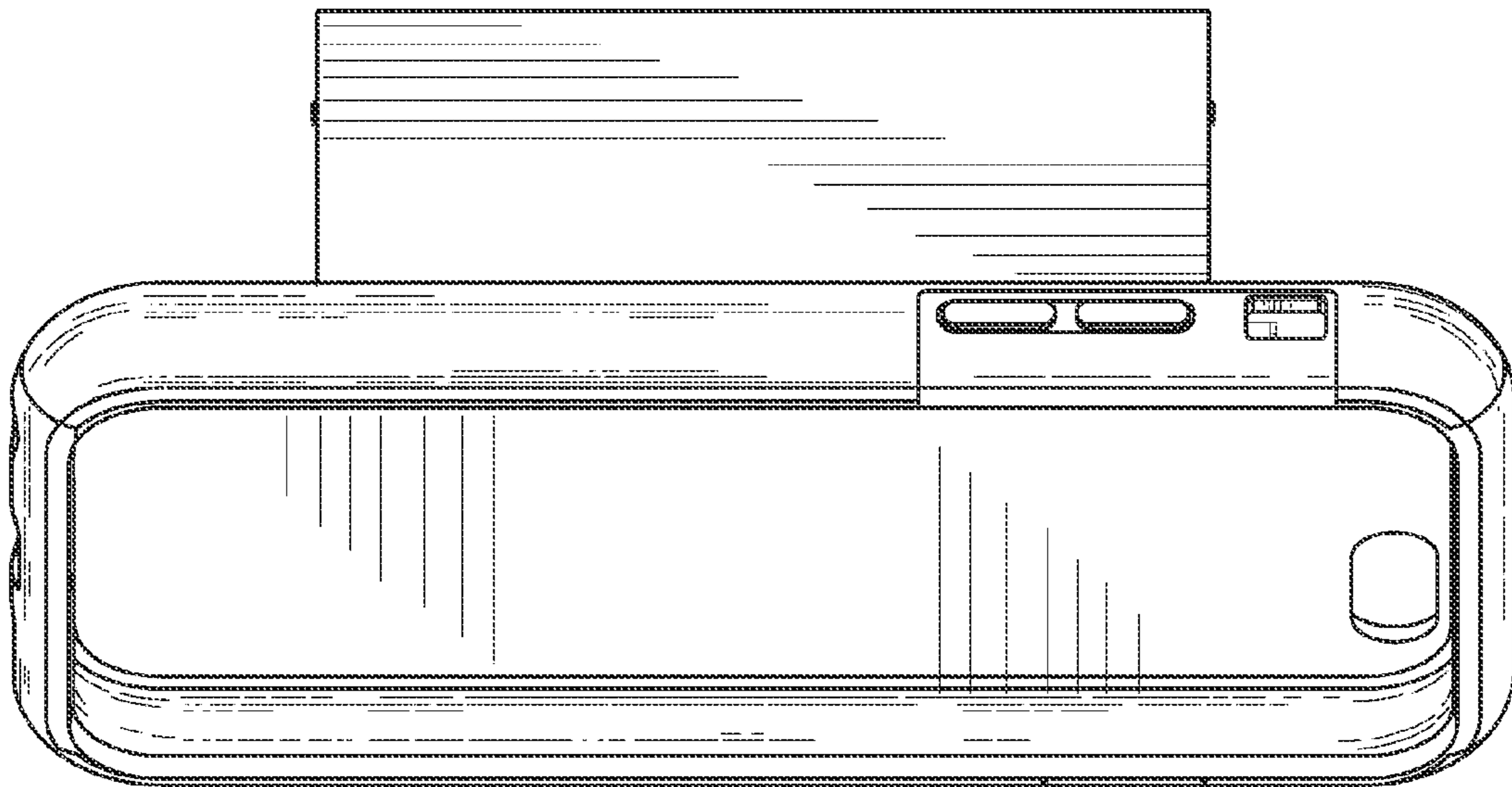

FIG. 9

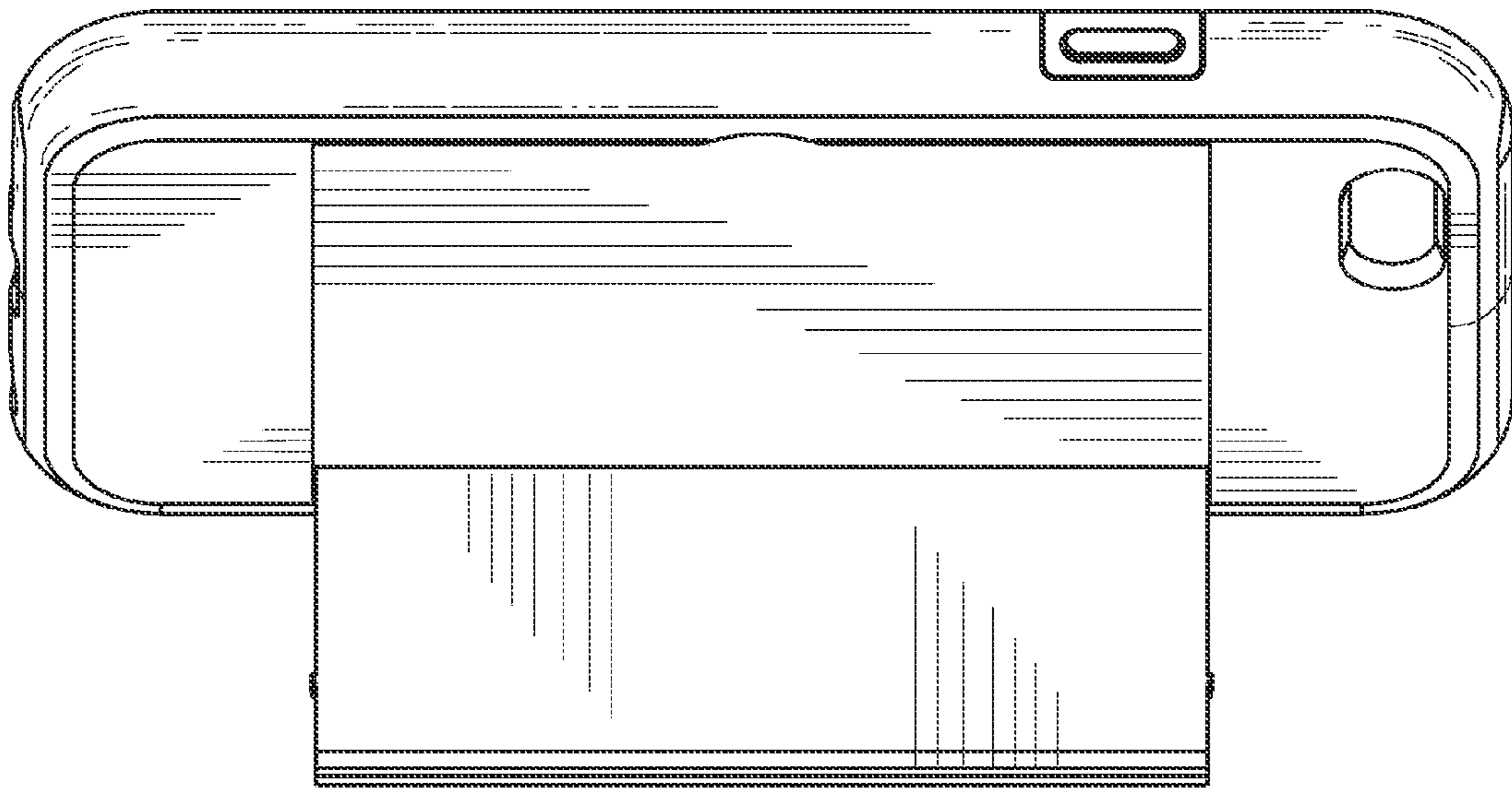

FIG. 10

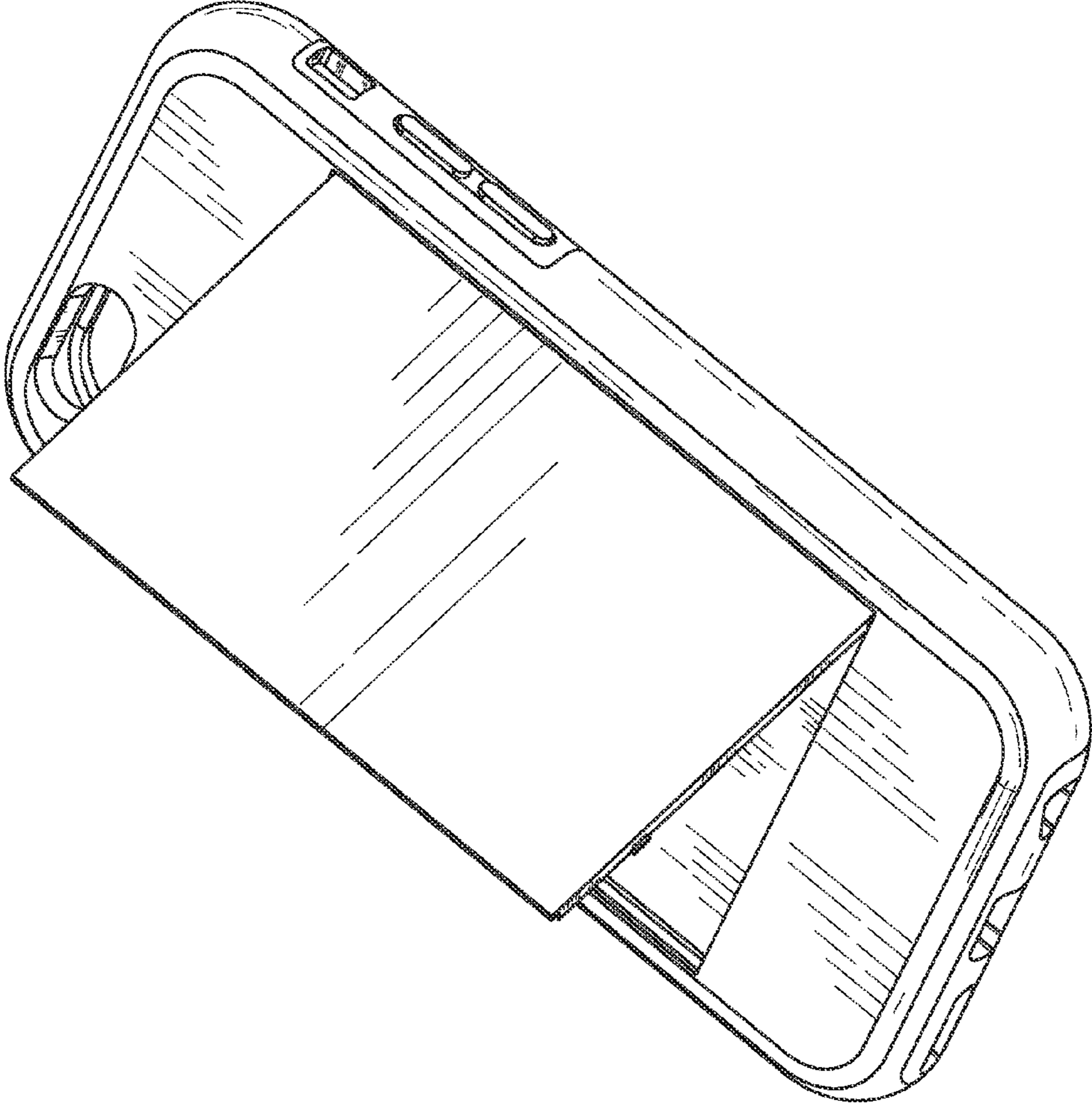

FIG. 11

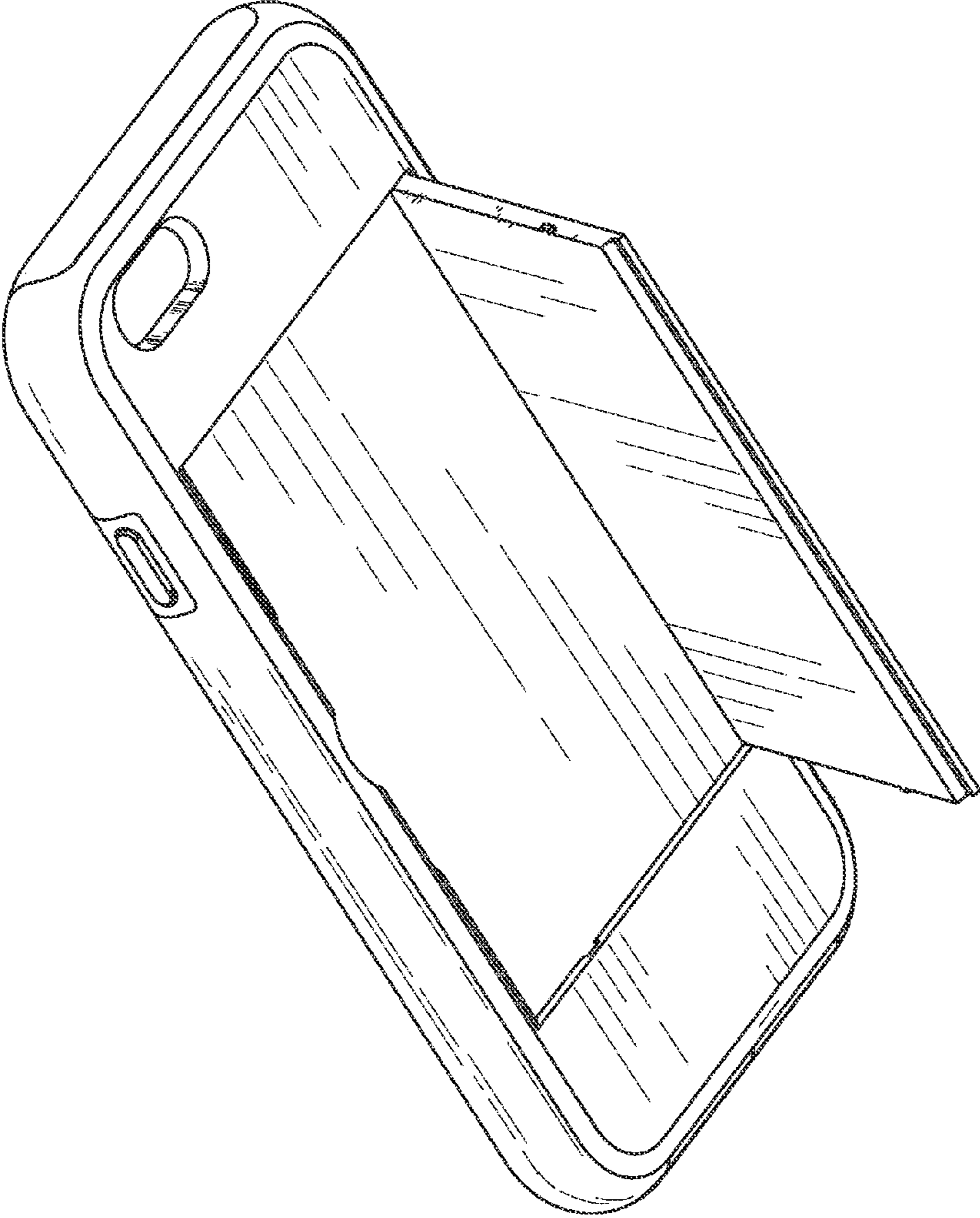

FIG. 12

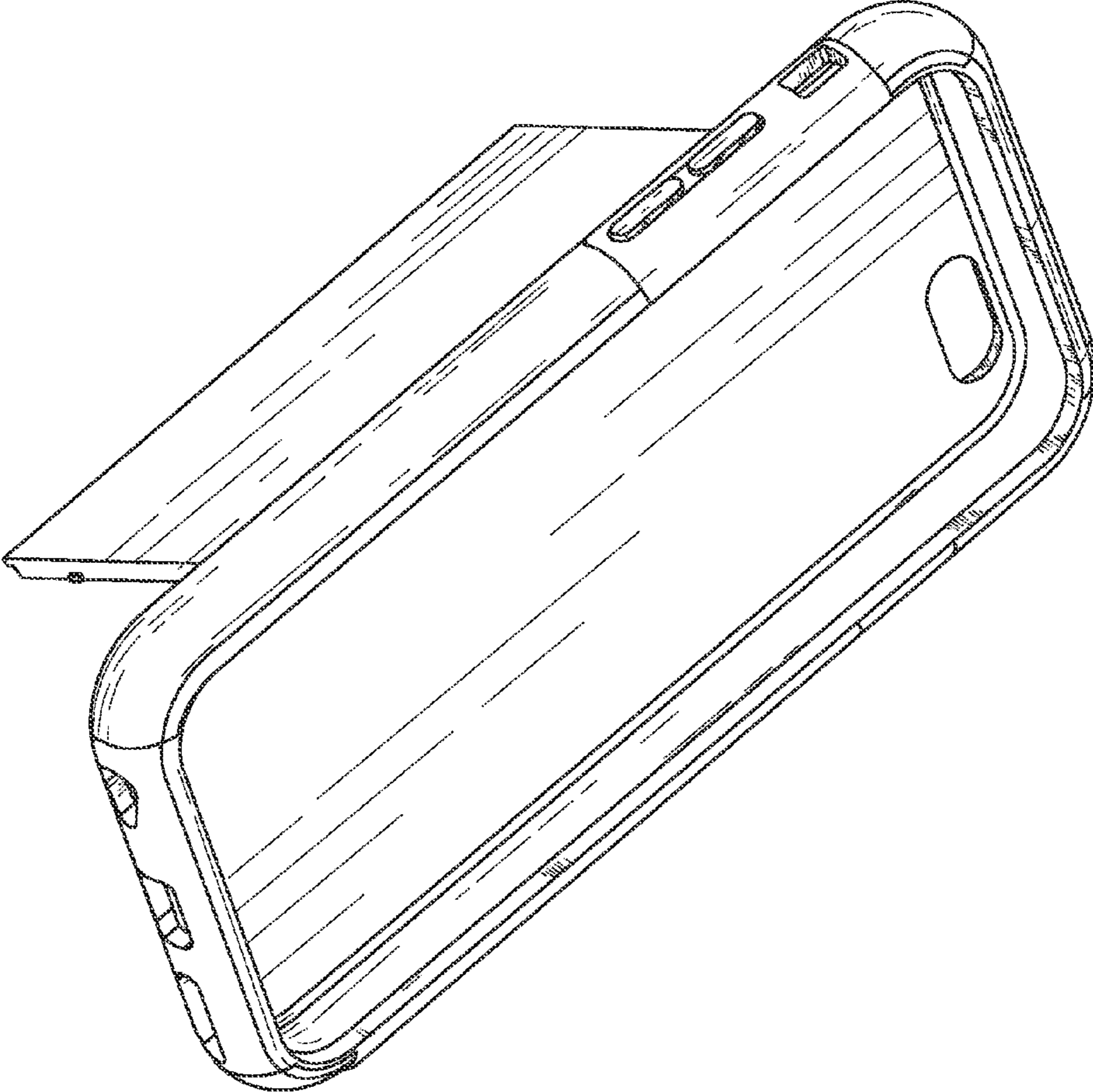

FIG. 13

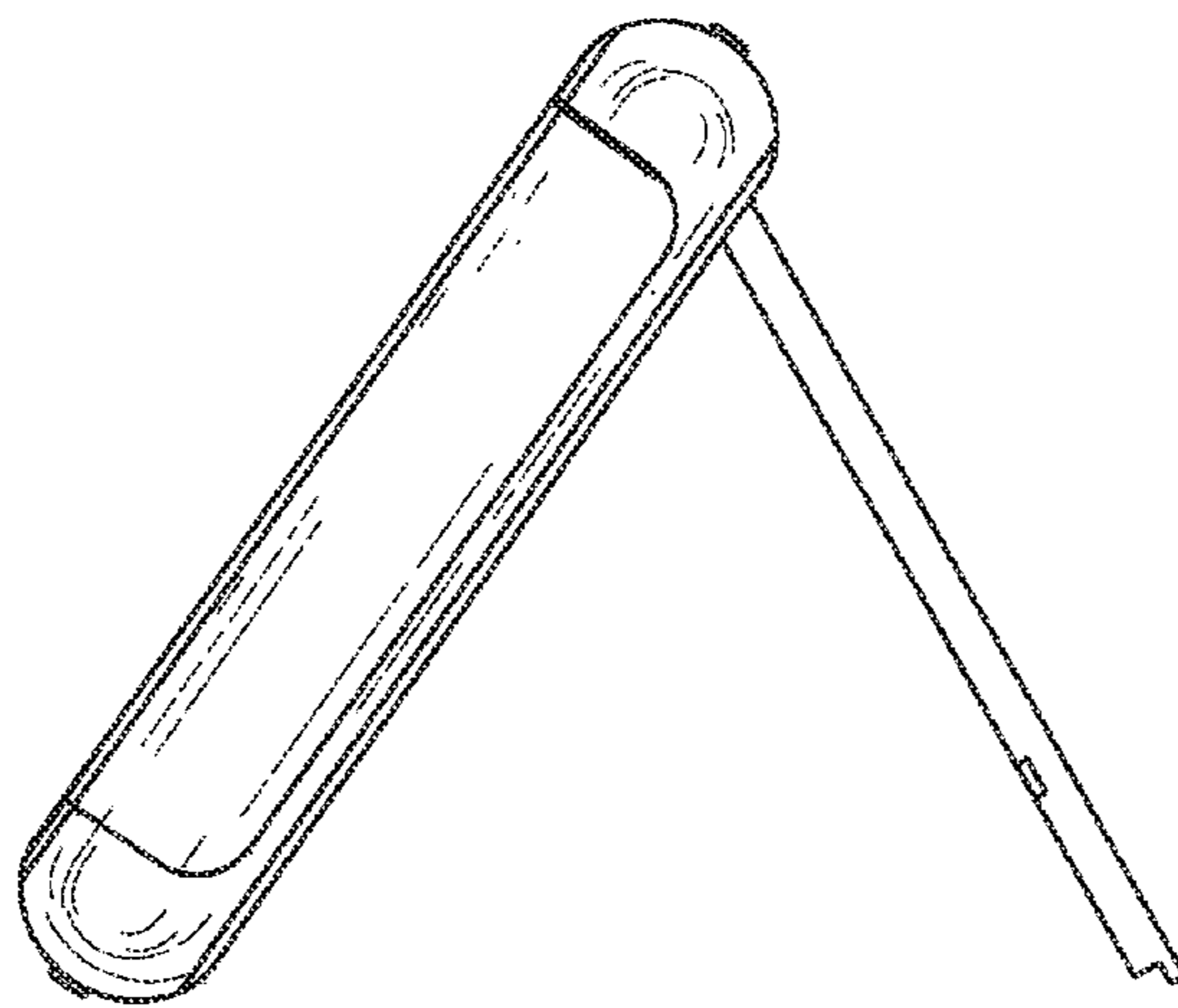

FIG. 14

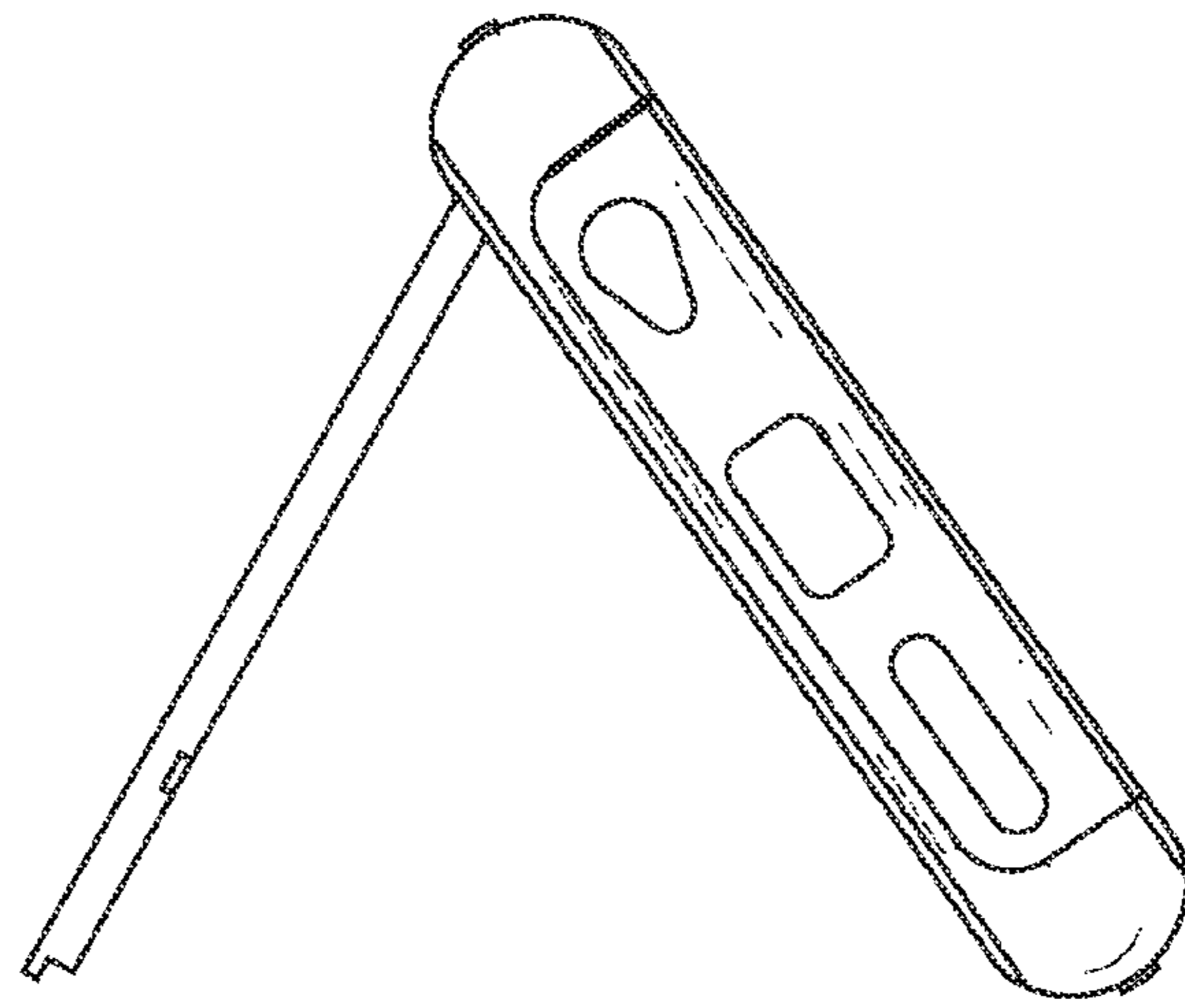

FIG. 15