



US00D749553S

(12) **United States Design Patent**
Park et al.

(10) **Patent No.:** **US D749,553 S**

(45) **Date of Patent:** **** *Feb. 16, 2016**

(54) **COVER FOR MOBILE PHONE**

- (71) Applicant: **Samsung Electronics Co., Ltd.**,
Suwon-si (KR)
- (72) Inventors: **Yun-Jin Park**, Seoul (KR); **Min-Geun Kim**, Goyang-si (KR)
- (73) Assignee: **Samsung Electronics Co., Ltd.**,
Suwon-si (KR)
- (*) Notice: This patent is subject to a terminal disclaimer.
- (**) Term: **14 Years**
- (21) Appl. No.: **29/475,219**
- (22) Filed: **Dec. 2, 2013**

(30) **Foreign Application Priority Data**

Jun. 20, 2013 (KR) 30-2013-0031868

(51) **LOC (10) Cl.** **14-03**

(52) **U.S. Cl.**
USPC **D14/250**

(58) **Field of Classification Search**

USPC D14/250–253, 440, 203.3–203.7, 217,
D14/496, 248, 238.1, 240, 447; D3/201,
D3/218, 269, 301, 273, 303; D13/103,
D13/107–108; 220/4.02; 248/309.1;
361/679.56; 379/426, 433.11, 455;
455/575.1, 575.8; 190/100; 206/305,
206/320

CPC A45C 2011/002; A45C 11/00; A45C
13/002; A45C 2011/003; H04M 1/0283;
H04M 1/0202

See application file for complete search history.

(56) **References Cited**

U.S. PATENT DOCUMENTS

D317,977 S * 7/1991 Felkner et al. D3/299
D582,405 S * 12/2008 Andre et al. D3/299

(Continued)

OTHER PUBLICATIONS

Samsung Flip Cover + for Samsung Galaxy S4 Zoom, http://www.mobilefun.co.uk/41669-samsung-flip-cover-for-samsung-galaxy-s4-zoomwhite-Reviews.htm?show_rating=&locale_filter=5&sort_by=&show_all=#reviews, earliest customer review: Mar. 18, 2014, retrieved from internet on May 16, 2015.*

Primary Examiner — Carla Jobe Wright

Assistant Examiner — Holly E Thurman

(74) *Attorney, Agent, or Firm* — NSIP Law

(57) **CLAIM**

The ornamental design for a cover for mobile phone, as shown and described.

DESCRIPTION

FIG. 1 is a top front perspective view of a cover for mobile phone showing our new design;
FIG. 2 is a front view thereof;
FIG. 3 is a rear view thereof;
FIG. 4 is a left side view thereof;
FIG. 5 is a right side view thereof;
FIG. 6 is a top view thereof;
FIG. 7 is a bottom view thereof;
FIG. 8 is a top rear perspective view thereof;
FIG. 9 is another rear perspective view thereof, showing an unclaimed mobile phone within the cover;
FIG. 10 is another top view thereof, in which the front flap is shown in an open position;
FIG. 11 is another top view thereof in which the front flap is shown in a folded open position; and,
FIG. 12 is an enlarged view of the encircled portion, as shown in FIG. 5.

In FIGS. 5 and 12, the dot-dash broken lines encircle and indicate a portion of the claimed design shown on an enlarged scale in FIG. 12. All other dot-dash broken lines represent boundaries of the claimed design.

The dash-dash broken lines depict an unclaimed mobile phone and unclaimed environmental features of the cover for mobile phone. The broken lines form no part of the claimed design.

1 Claim, 10 Drawing Sheets

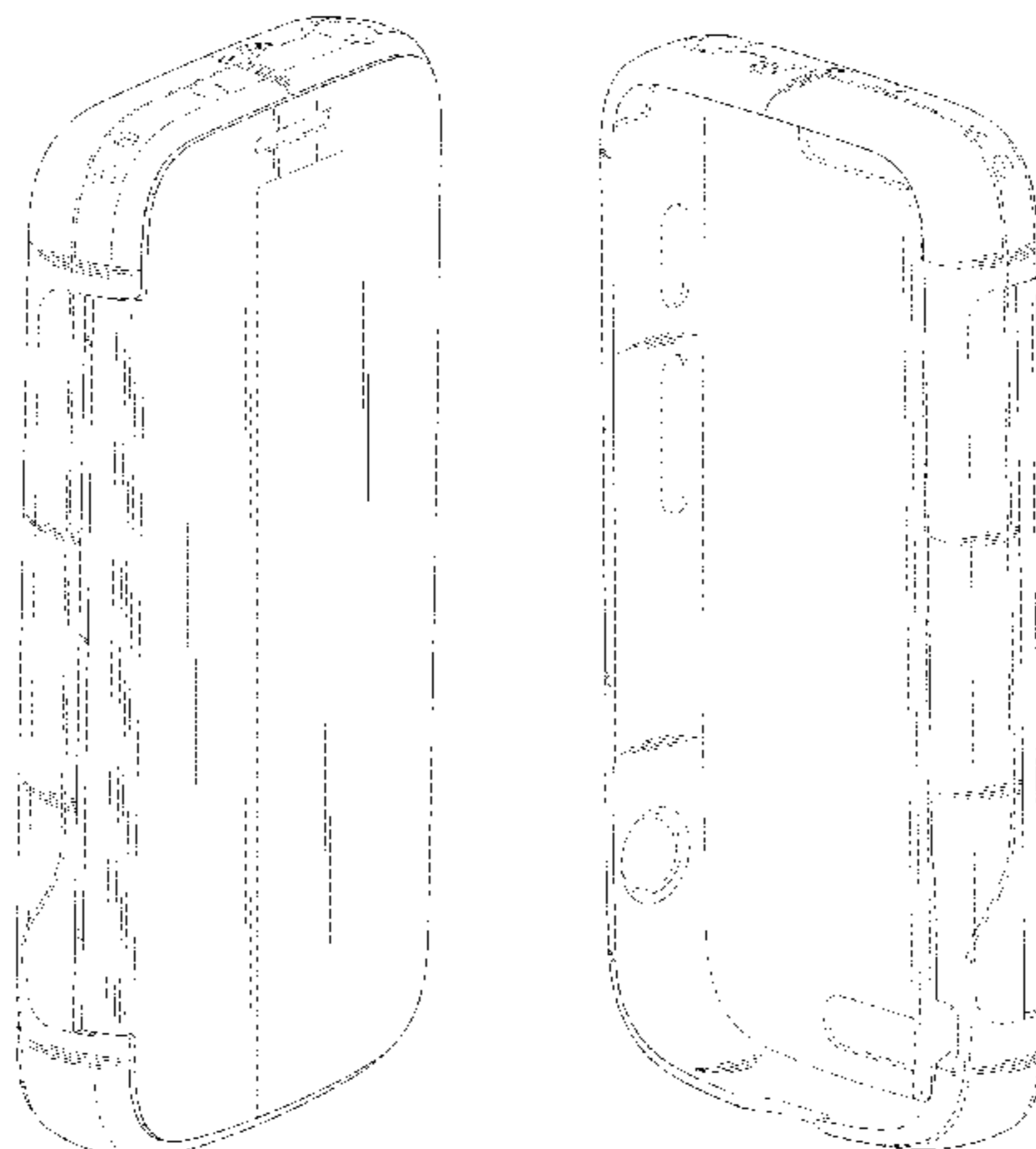

(56)

References Cited

U.S. PATENT DOCUMENTS

D602,461 S *	10/2009	Kim et al.	D14/138 AD	D707,218 S *	6/2014	YoonYoung	D14/250
D657,354 S *	4/2012	Kim	D14/250	D707,219 S *	6/2014	Kim	D14/250
D678,260 S *	3/2013	Bau	D14/250	D708,172 S *	7/2014	Ryu et al.	D14/250
D684,960 S *	6/2013	Murchison et al.	D14/250	D714,053 S *	9/2014	Yoo	D3/269
D684,961 S *	6/2013	Murchison et al.	D14/250	D714,550 S *	10/2014	Yoo	D3/269
8,457,702 B2 *	6/2013	Lee	455/575.8	D720,733 S *	1/2015	Fathollahi	D14/250
D685,363 S *	7/2013	Murchison et al.	D14/250	D723,019 S *	2/2015	Chan et al.	D14/250
D694,741 S *	12/2013	Kim	D14/250	D723,020 S *	2/2015	Kim et al.	D14/250
D696,236 S *	12/2013	Murchison et al.	D14/250	D723,038 S *	2/2015	Kim	D14/440
D700,599 S *	3/2014	Kim	D14/250	D723,534 S *	3/2015	Kim et al.	D14/250
D702,222 S *	4/2014	Kim	D14/250	D724,572 S *	3/2015	Wildner	D14/250
D702,673 S *	4/2014	Murchison et al.	D14/250	D724,593 S *	3/2015	Cohen	D14/440
D704,691 S *	5/2014	Kim et al.	D14/250	2010/0062816 A1 *	3/2010	Yu	455/575.8
D705,207 S *	5/2014	Kim et al.	D14/250	2012/0085679 A1 *	4/2012	Kim et al.	206/736
					2012/0178507 A1 *	7/2012	Lee	455/575.1
					2012/0244920 A1 *	9/2012	Lee	455/575.8

* cited by examiner

FIG. 1

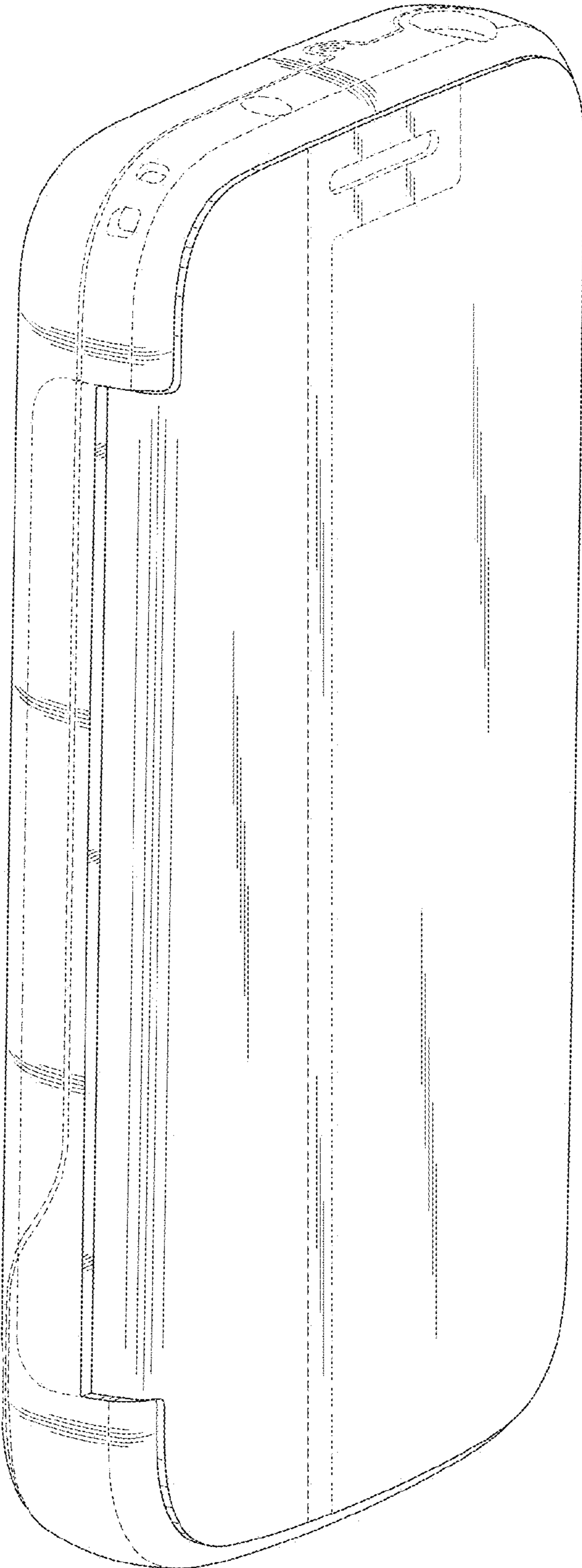

FIG.2

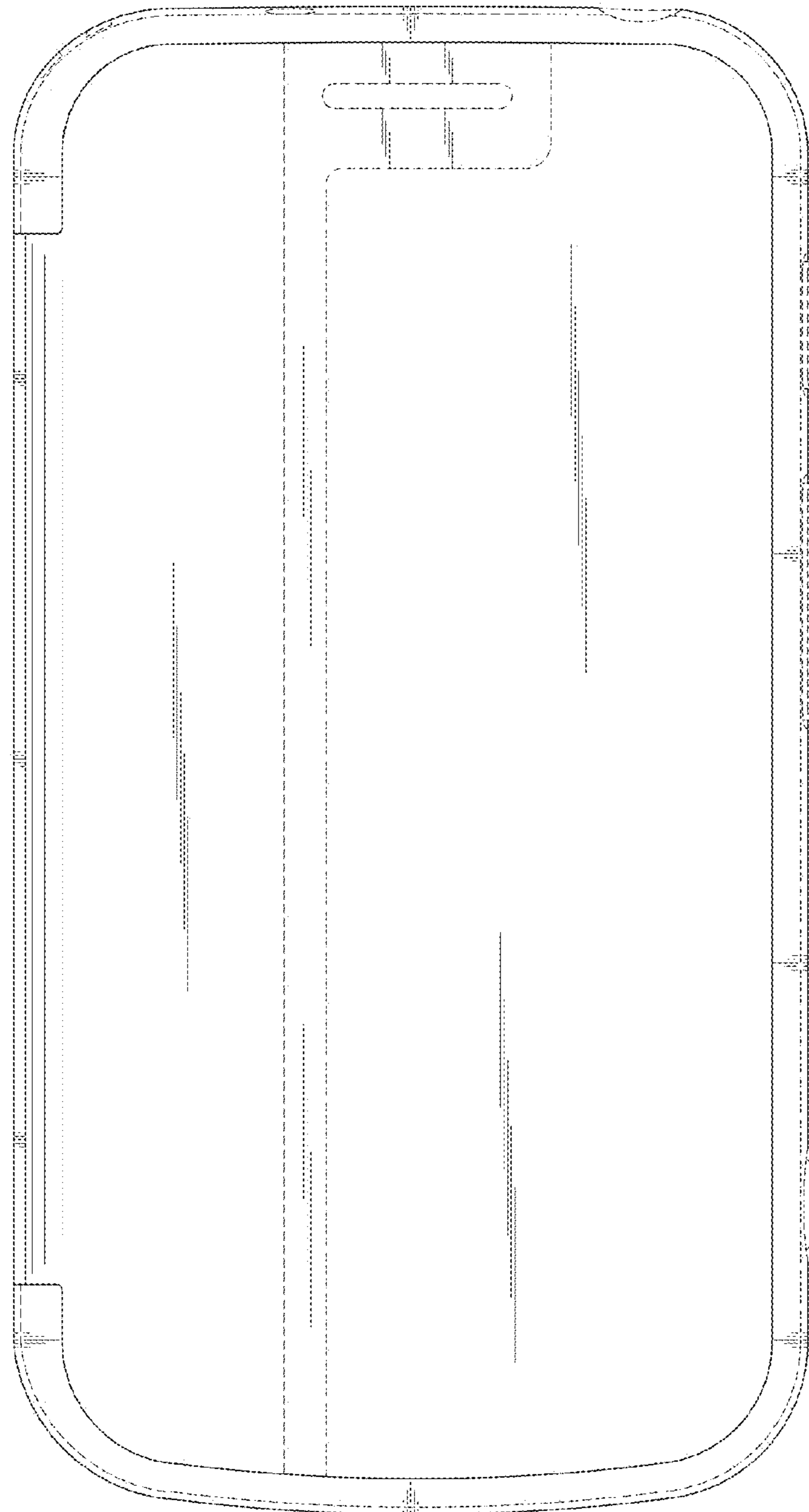

FIG.3

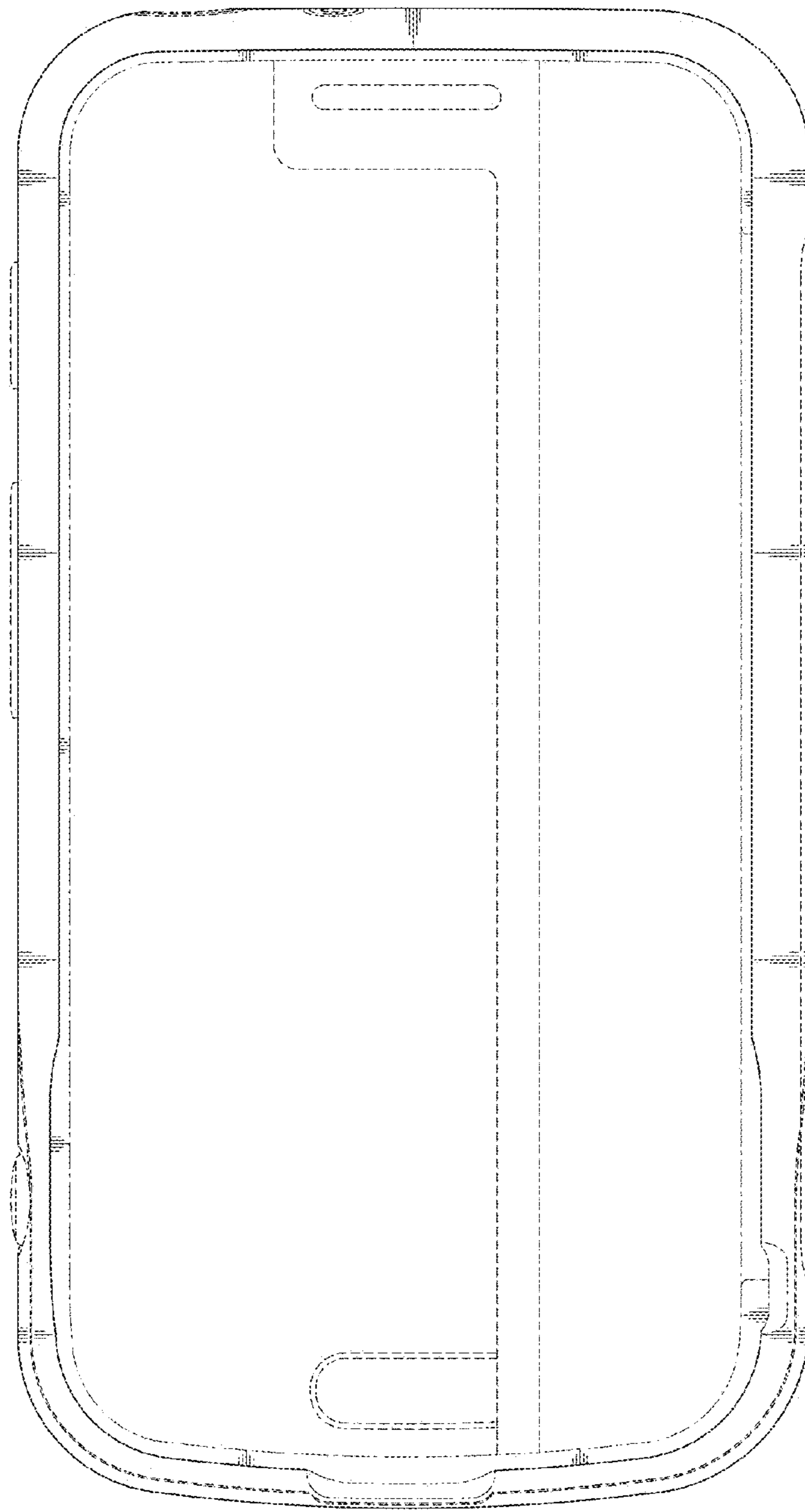

FIG.4

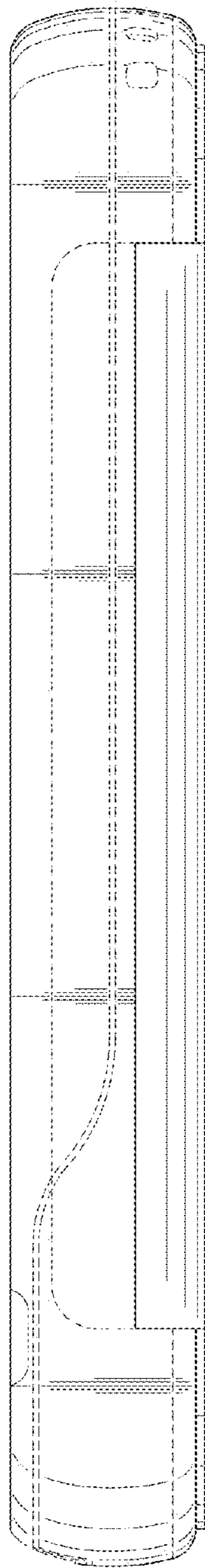

FIG.5

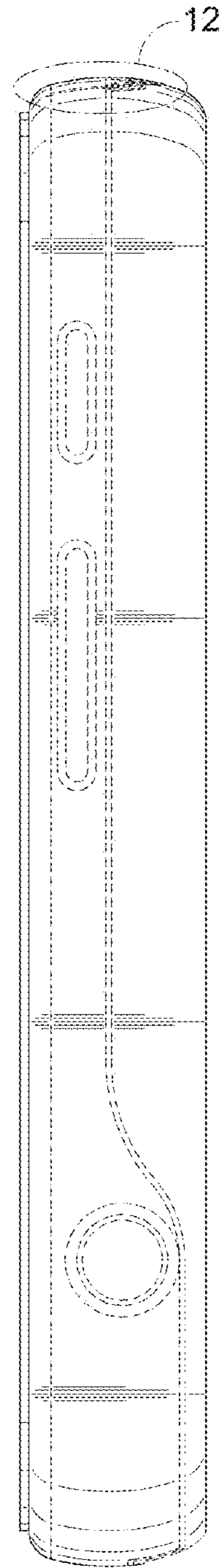

FIG.6

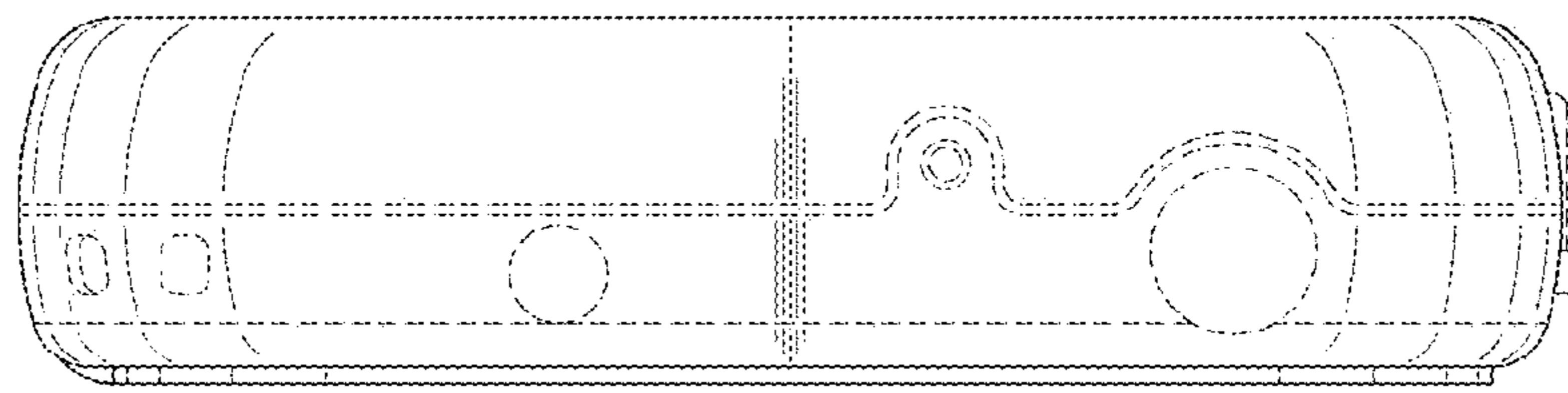

FIG.7

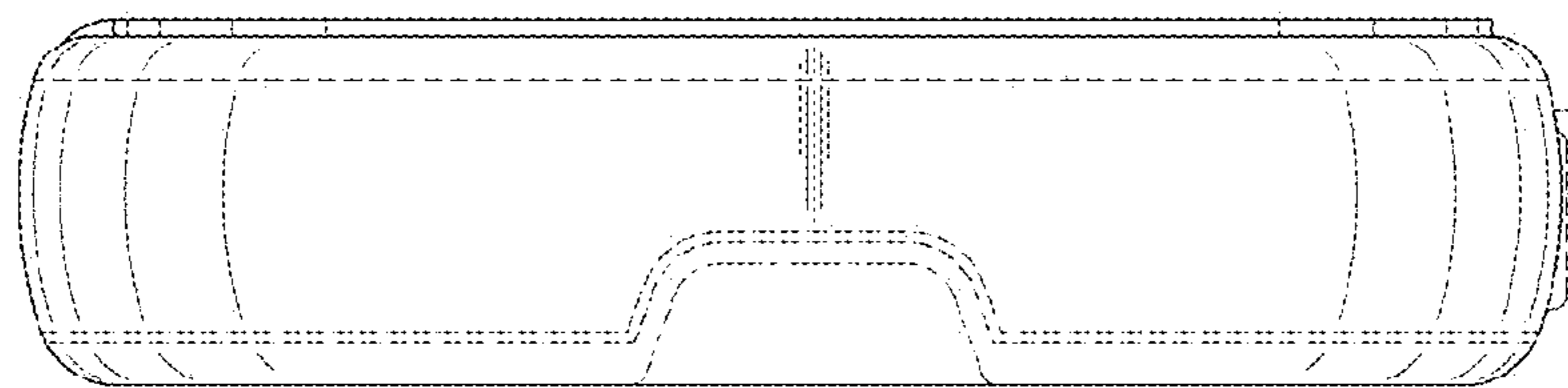

FIG.8

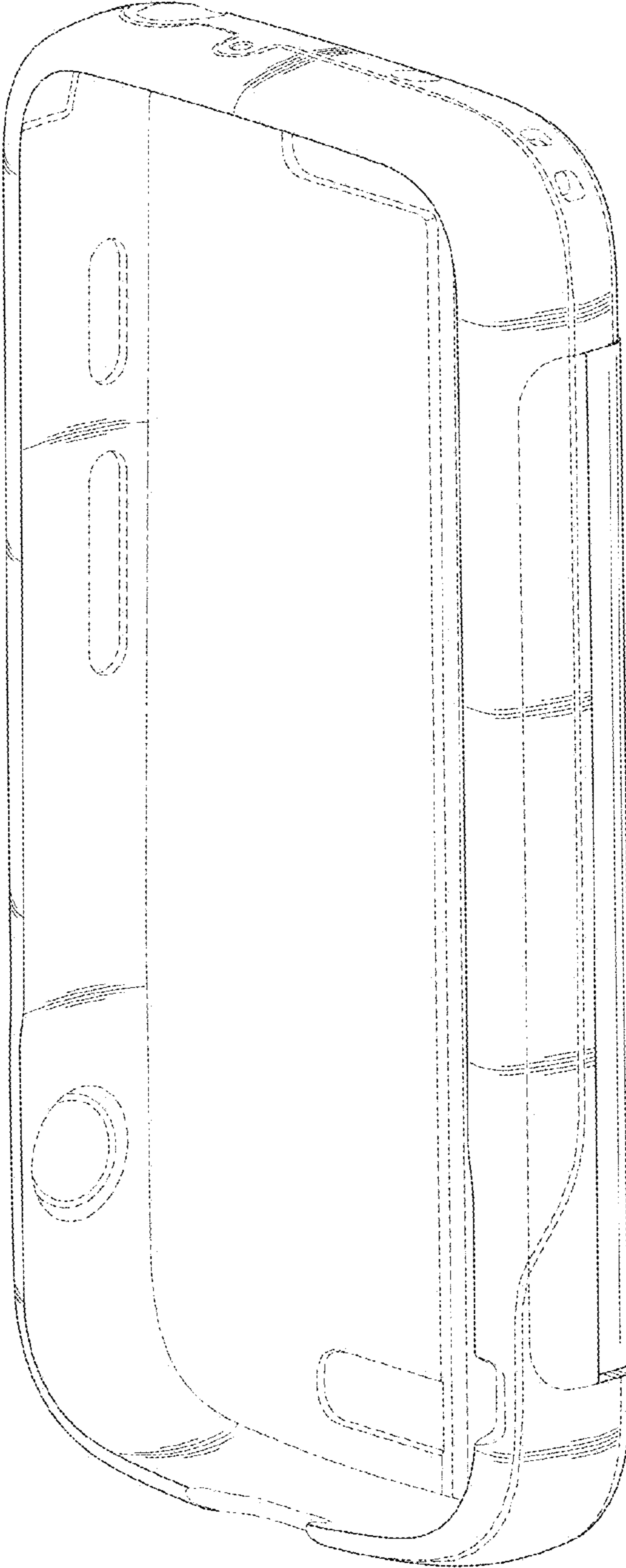

FIG. 9

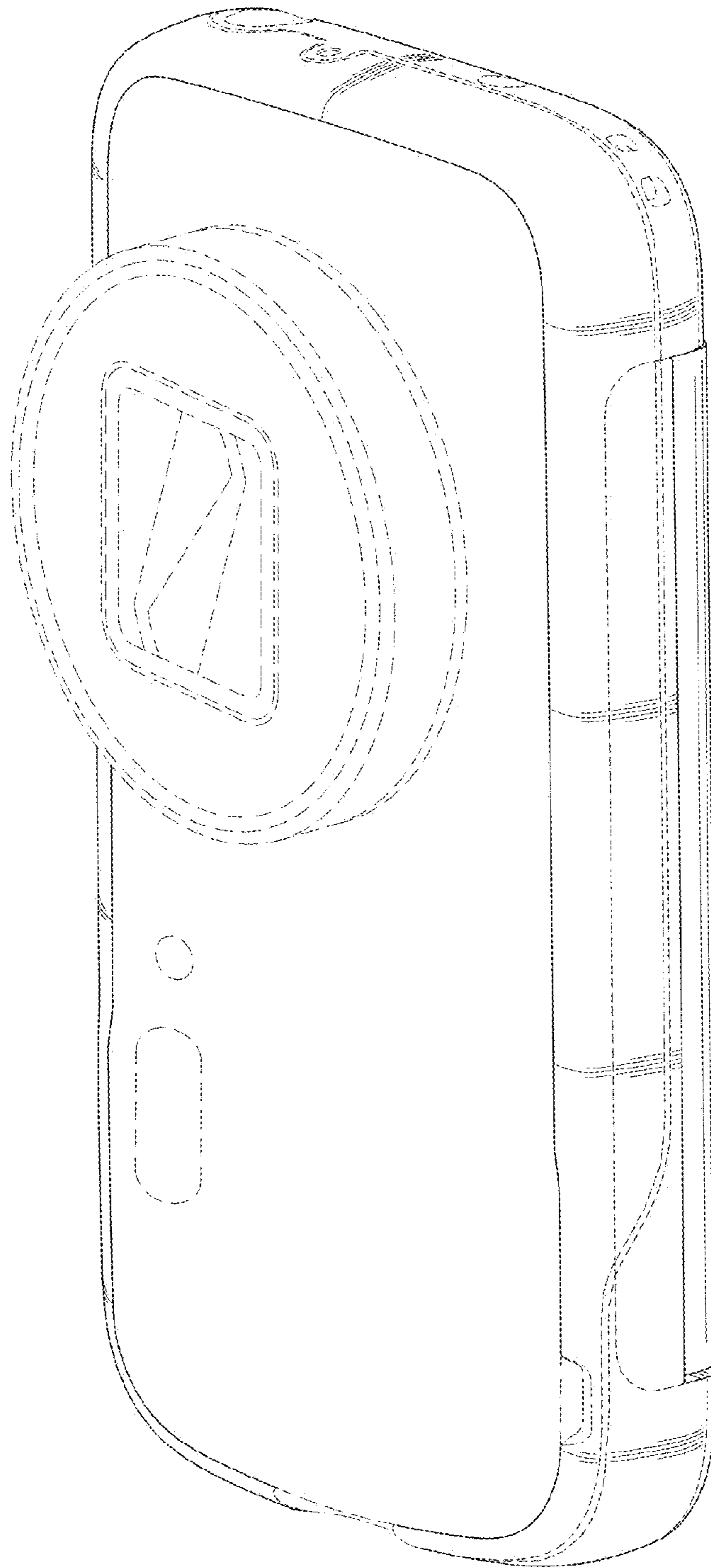

FIG. 10

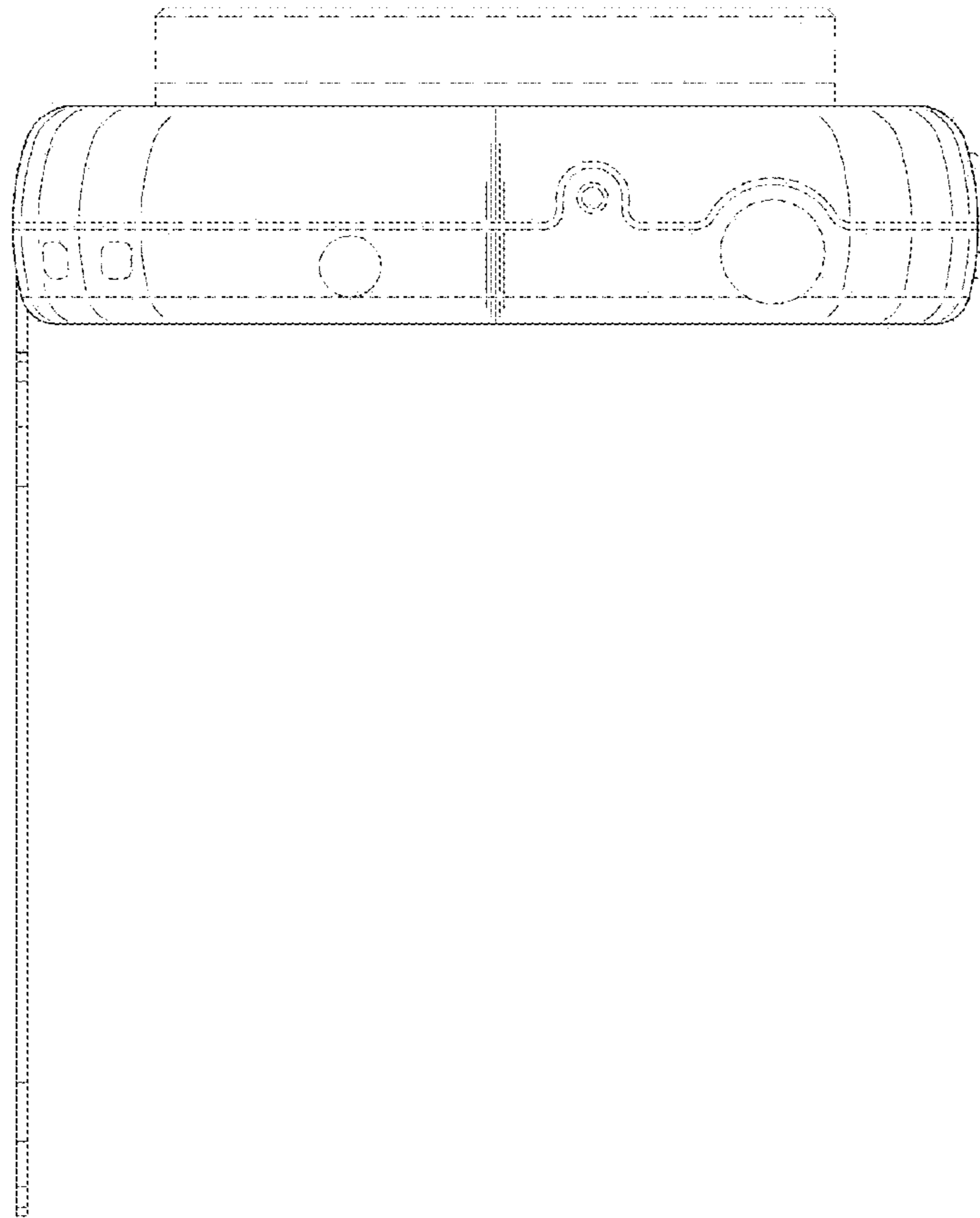

FIG.11

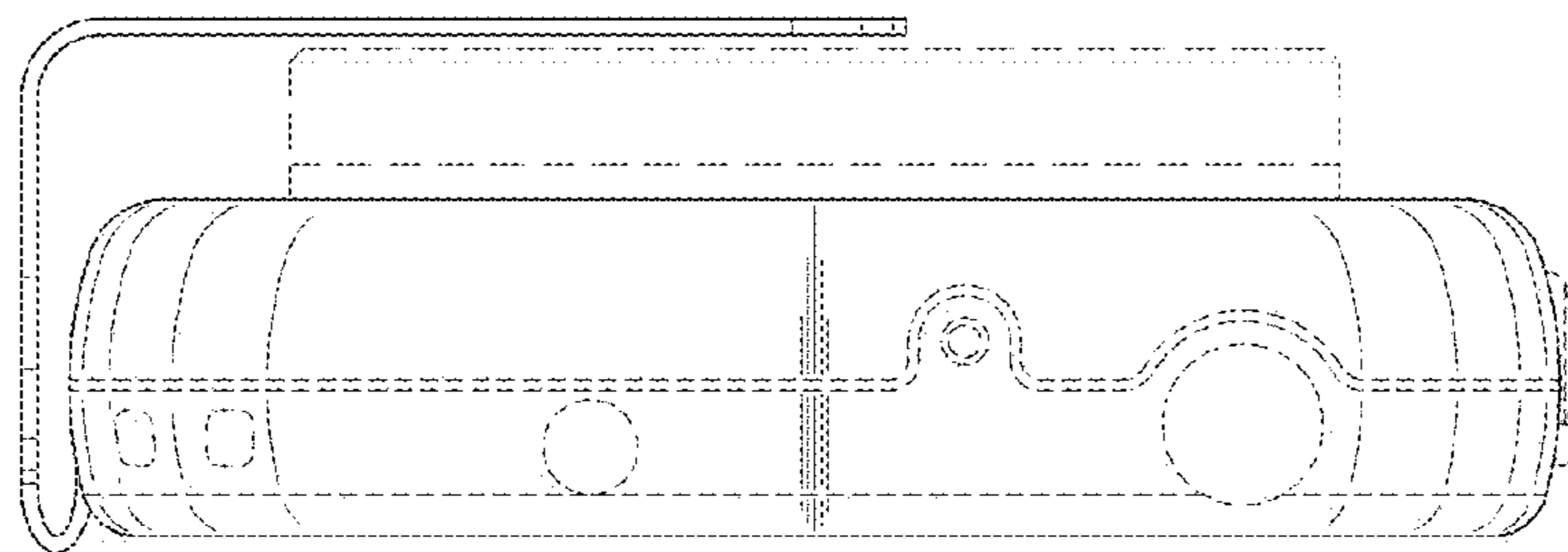

FIG. 12

