



US00D749458S

(12) **United States Design Patent**
Vaughan et al.

(10) **Patent No.:** **US D749,458 S**

(45) **Date of Patent:** **** Feb. 16, 2016**

(54) **PENDANT**

(71) Applicant: **Athletes for Christ, LP**, Beaumont, TX (US)

(72) Inventors: **John Kennedy Vaughan**, Beaumont, TX (US); **Tammie Vaughan**, Beaumont, TX (US)

(73) Assignee: **ATHLETES FOR CHRIST, LP**, Beaumont, TX (US)

(**) Term: **14 Years**

(21) Appl. No.: **29/503,240**

(22) Filed: **Sep. 24, 2014**

(51) **LOC (10) Cl.** **11-01**

(52) **U.S. Cl.**
USPC **D11/81**

(58) **Field of Classification Search**
USPC D11/79-86, 1, 2, 7, 9, 11, 13, 15;
63/40, 12, 13, 18, 20; D21/301,
D21/707-714, 788, 406; 473/52, 53,
473/125-130, 280, 281; D9/668;
D3/207-211
CPC A44C 25/00; A44C 25/001; A44C 25/007;
A44C 25/008; A45C 13/185; A45C 13/20;
A63B 37/00; A63B 37/0098; A63B 2039/003;
A63B 2039/006; A63B 41/00

See application file for complete search history.

(56) **References Cited**

U.S. PATENT DOCUMENTS

- 1,528,463 A * 3/1925 Yungk G10K 1/071
116/148
- D128,157 S * 7/1941 Berry D11/9
- D151,599 S * 11/1948 Colm 428/11
- D206,176 S * 11/1966 Guarino D10/119.4
- D288,984 S * 3/1987 Scheurer D3/211
- D339,916 S * 10/1993 Behbahani D21/712
- D408,237 S * 4/1999 Wysopal D3/211

- D446,148 S * 8/2001 Kelly D11/6
- D474,872 S * 5/2003 Sullivan D99/26
- D507,314 S * 7/2005 Horkan D21/712
- D518,536 S * 4/2006 Chang D21/712
- D520,737 S * 5/2006 Gotlieb D3/211
- D551,308 S * 9/2007 Chang D21/712
- D551,721 S * 9/2007 Cooper D21/406
- D562,177 S * 2/2008 Cohen D11/81
- D565,288 S * 4/2008 Hickman D3/201
- D587,968 S * 3/2009 Campbell D7/510
- D594,605 S * 6/2009 DeLuco D30/153
- D698,696 S * 2/2014 McBurney D11/157
- D720,926 S * 1/2015 Kroupa D3/264
- D732,847 S * 6/2015 Jan D6/591

(Continued)

OTHER PUBLICATIONS

[Online] http://cdn1.bigcommerce.com/n-63unu/d05toasu/products/687/images/1026/Football_SS_1_77419.1423598576.1280.1280.jpg?c=2. Retrieved Oct. 16, 2015.*

(Continued)

Primary Examiner — Garth Rademaker
Assistant Examiner — Melanie Pellegrini
(74) *Attorney, Agent, or Firm* — Egbert Law Offices, PLLC

(57) **CLAIM**

The ornamental design for a pendant, as shown and described.

DESCRIPTION

FIG. 1 is a perspective view of a pendant showing our new design.
FIG. 2 is a front thereof;
FIG. 3 is a rear view thereof;
FIG. 4 is a top view thereof;
FIG. 5 is a bottom view thereof;
FIG. 6 is a side view thereof; and,
FIG. 7 is an opposite view thereof.
The broken lines in the drawings represent unclaimed portions of the pendant and form no part of the claimed design.

1 Claim, 3 Drawing Sheets

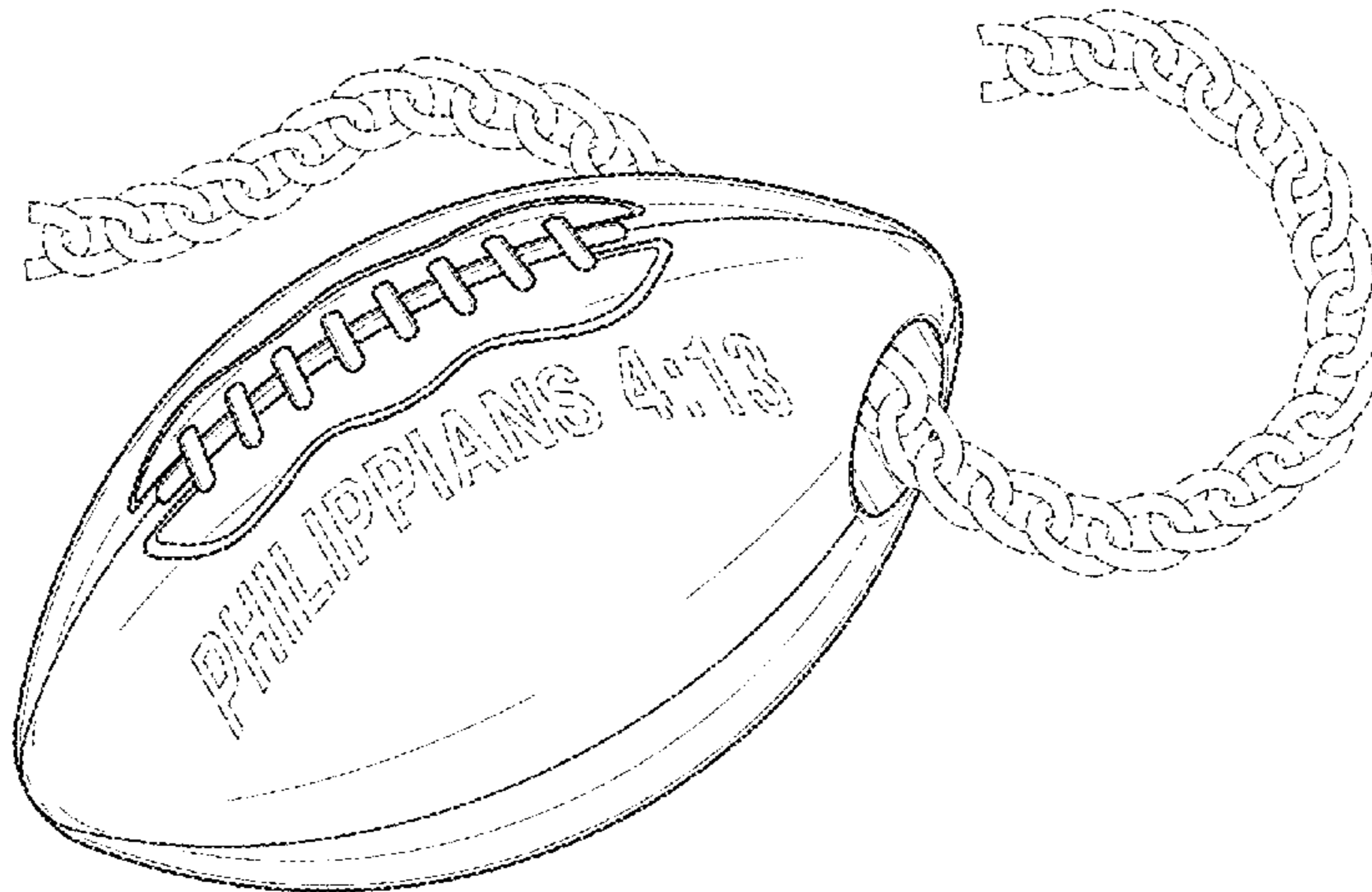

(56)

References Cited

U.S. PATENT DOCUMENTS

D734,513 S * 7/2015 Brown D26/16
D735,050 S * 7/2015 Tussy D9/668
2002/0095952 A1* 7/2002 Kelly A44C 11/002
63/3

OTHER PUBLICATIONS

[Online] <https://web.archive.org/web/20110910235227/http://www.argentsports.com/schools/nebraska/>. Available online at least as early as Sep. 10, 2011 via www.archive.org. Retrieved Oct. 16, 2015.*

* cited by examiner

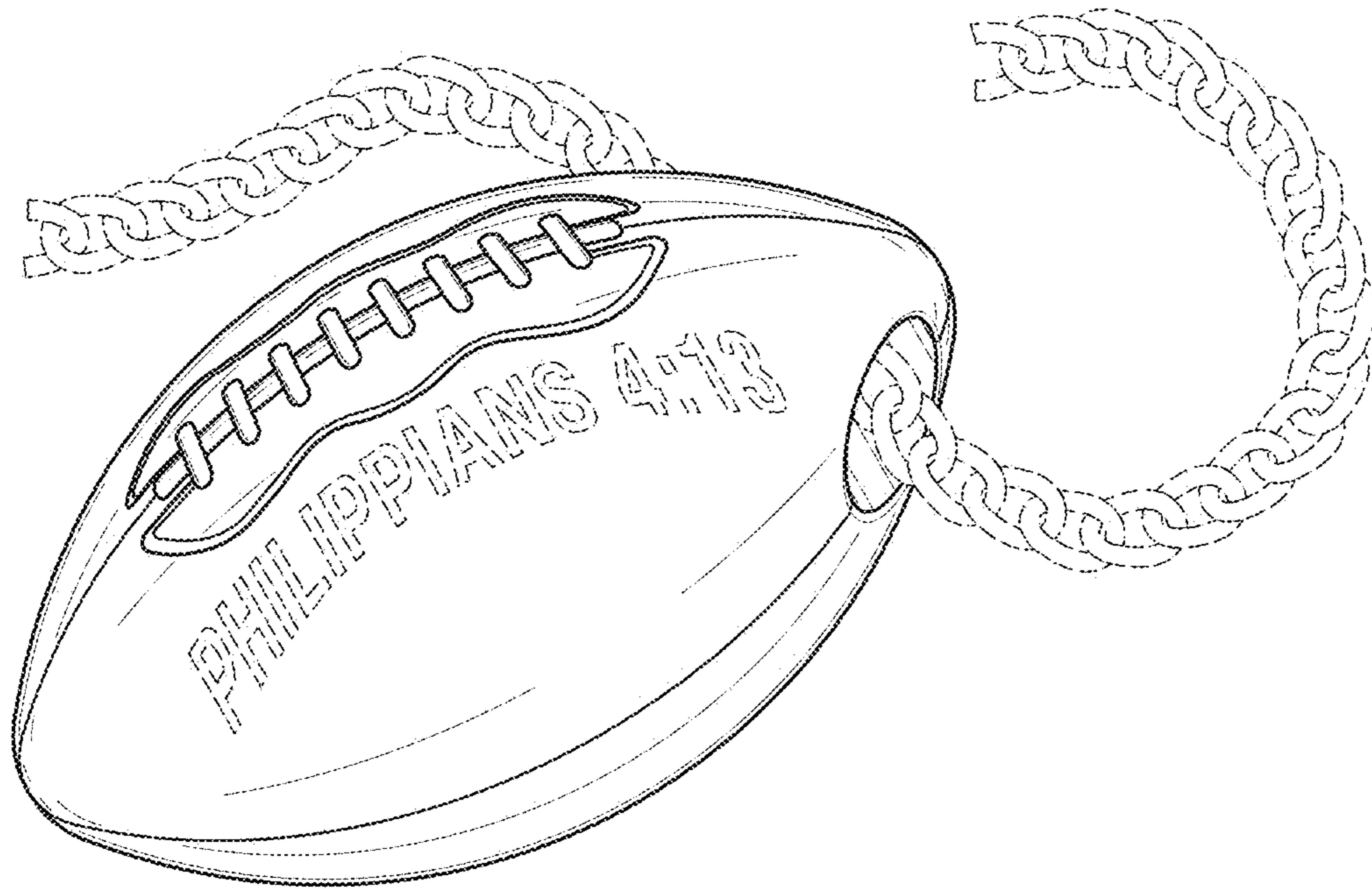

FIG. 1

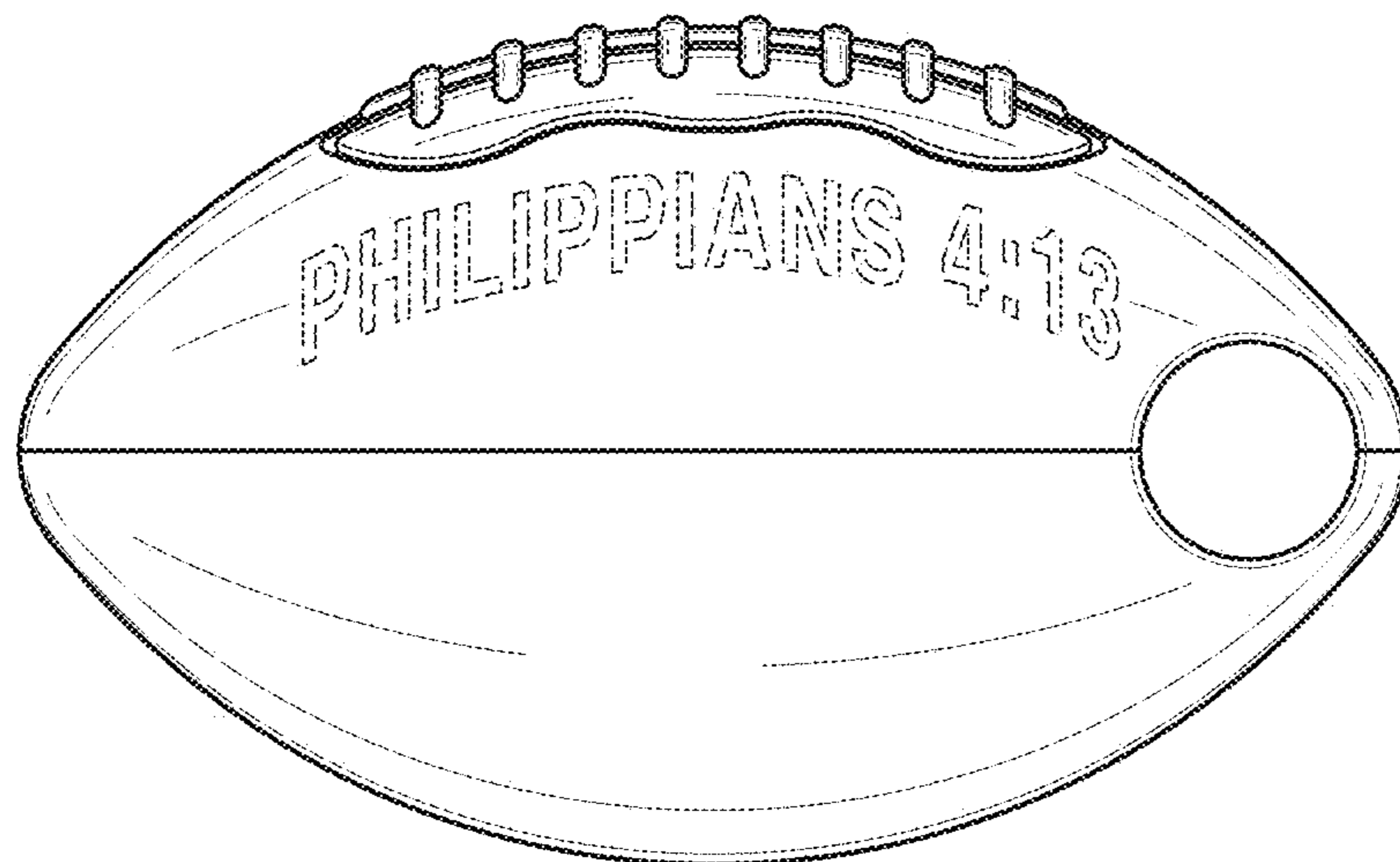

FIG. 2

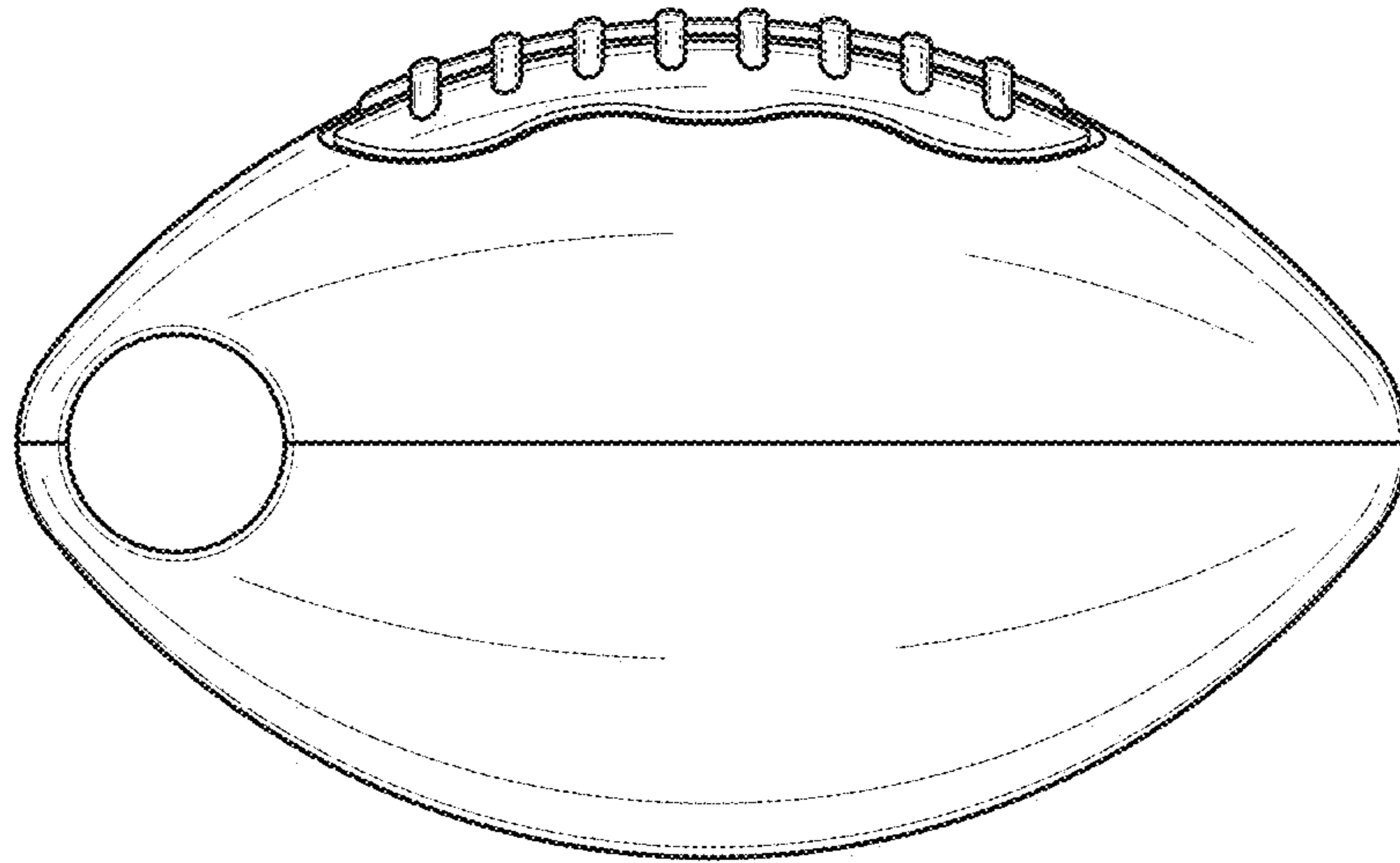

FIG. 3

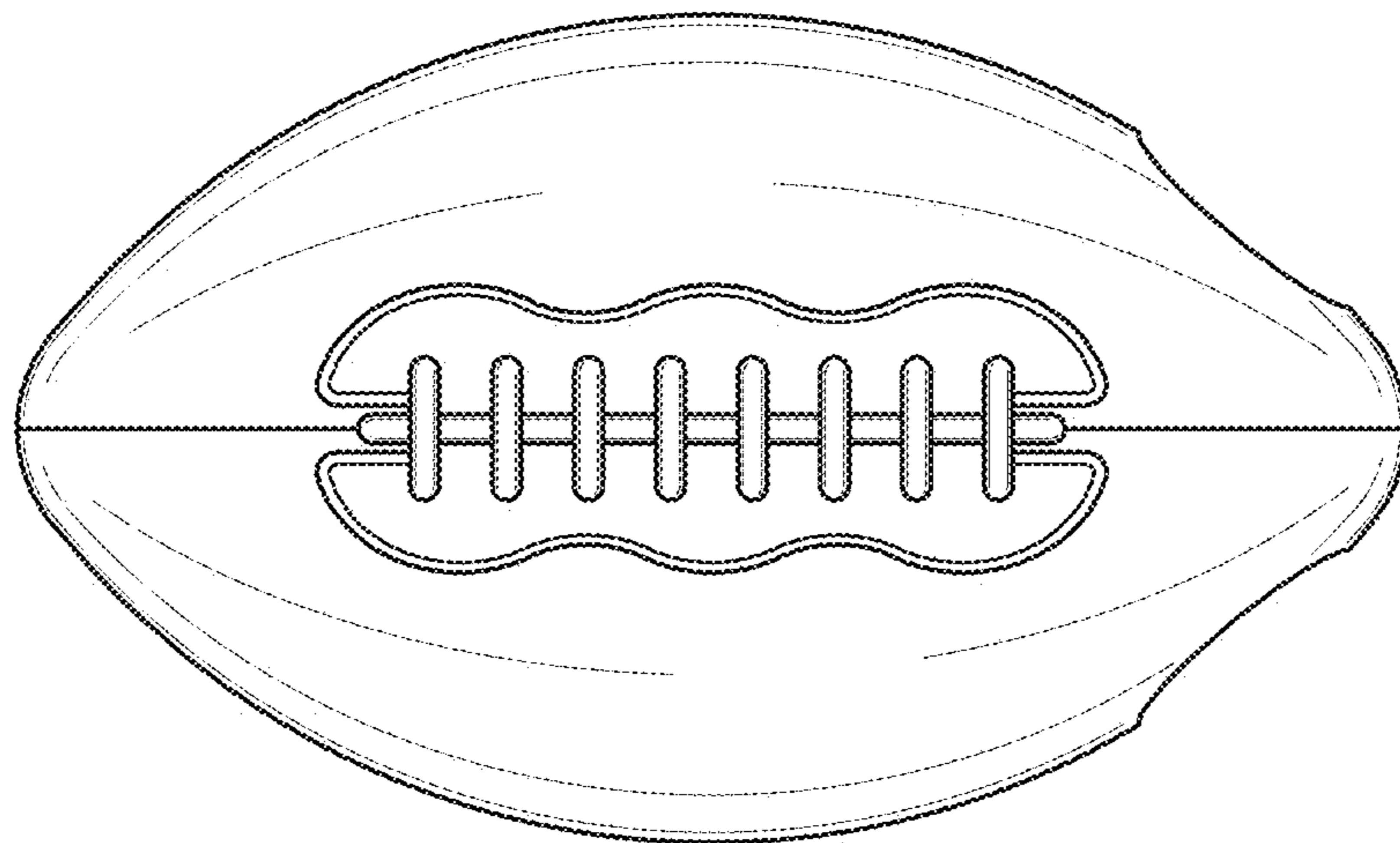

FIG. 4

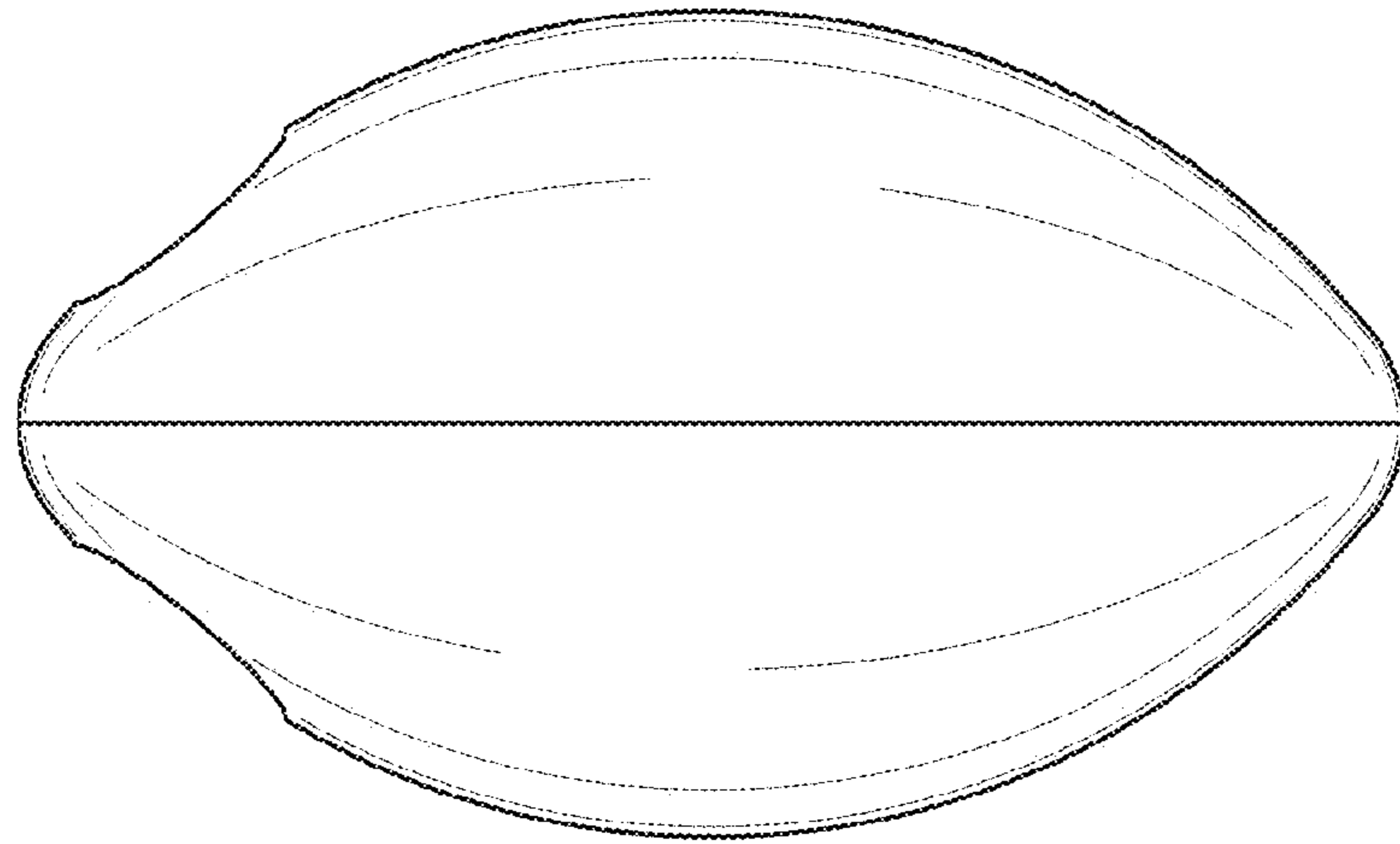

FIG. 5

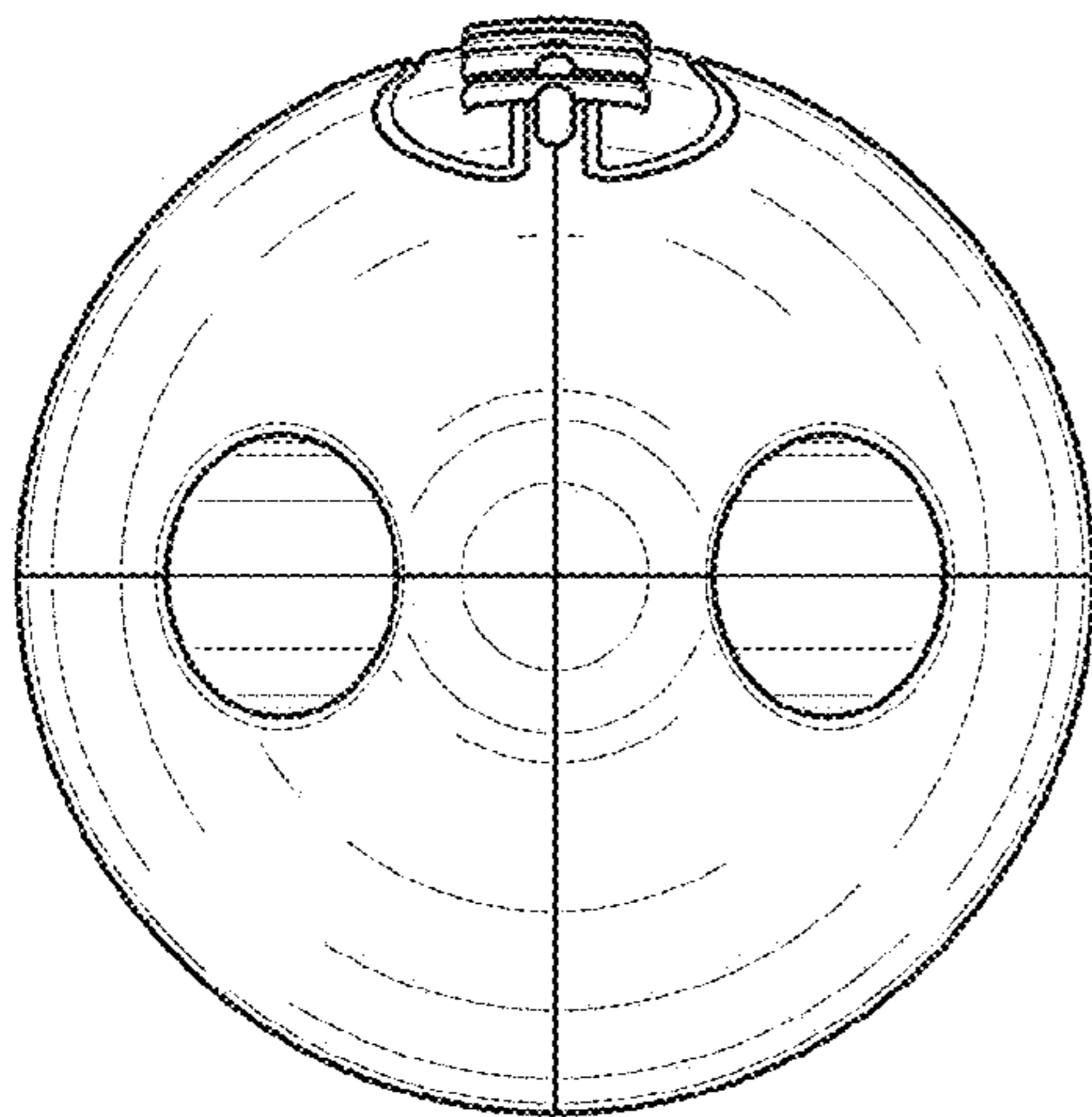

FIG. 6

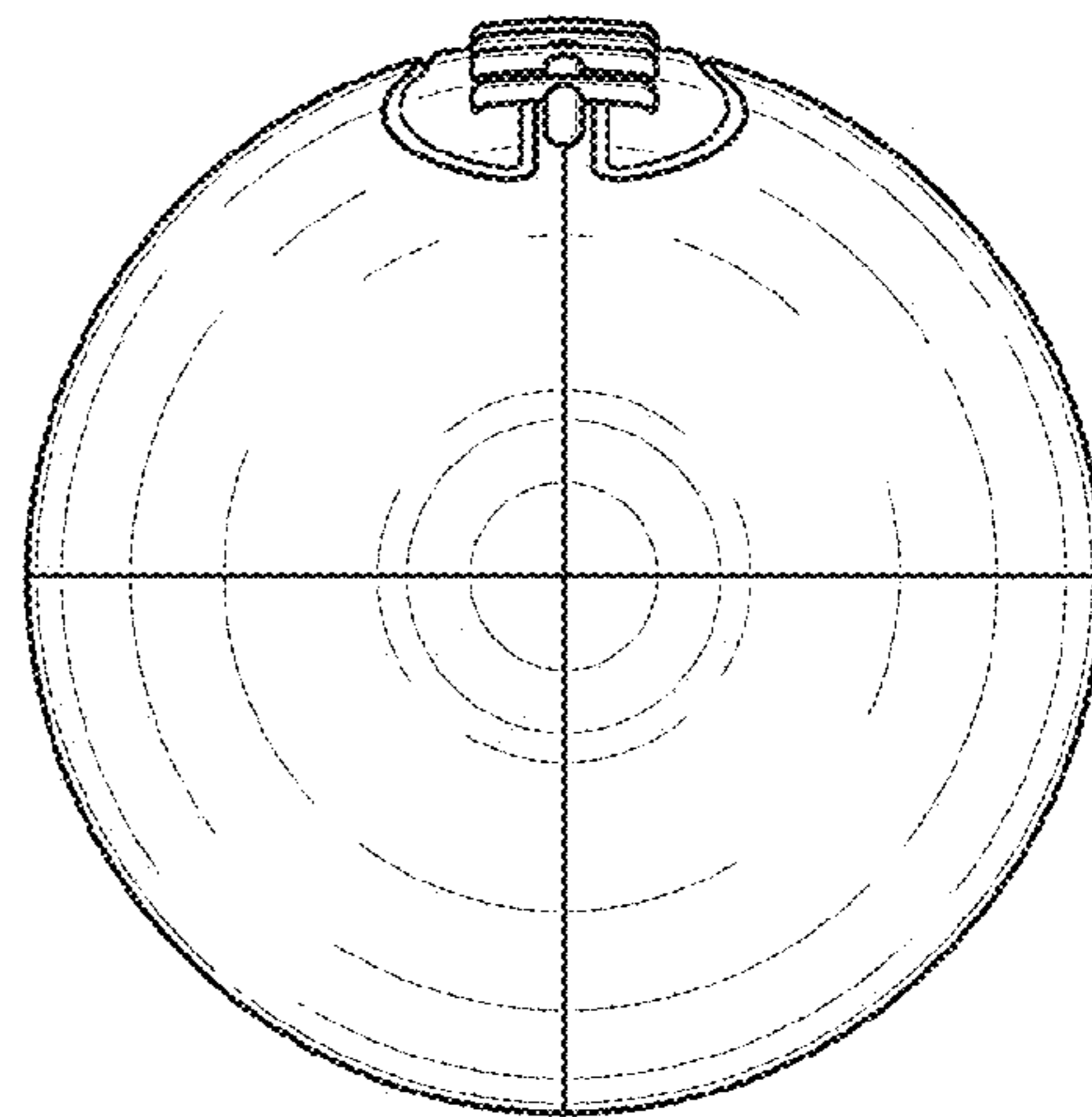

FIG. 7