



US00D749332S

(12) **United States Design Patent**
Prince et al.

(10) **Patent No.:** **US D749,332 S**
(45) **Date of Patent:** **** Feb. 16, 2016**

- (54) **SEAT**
- (71) Applicant: **J.C. BAMFORD EXCAVATORS LIMITED**, Uttoxeter (GB)
- (72) Inventors: **Mark Prince**, Uttoxeter (GB); **Paul Capper**, Uttoxeter (GB); **Ben Heron**, Uttoxeter (GB)
- (73) Assignee: **J.C. BAMFORD EXCAVATORS LIMITED**, Uttoxeter (GB)
- (**) Term: **14 Years**
- (21) Appl. No.: **29/490,619**
- (22) Filed: **May 12, 2014**
- (30) **Foreign Application Priority Data**
Feb. 28, 2014 (EM) 001405203
- (51) **LOC (10) Cl.** **06-01**
- (52) **U.S. Cl.**
USPC **D6/356**
- (58) **Field of Classification Search**
USPC D6/334-336, 356, 367, 368, 374, 375, D6/716, 716.1, 716.2, 716.3, 716.4
CPC B60N 2/48; B60N 2/00; B60N 2/22; B60N 2/4882; A47C 7/022; A47C 7/18; A47C 7/40
See application file for complete search history.

(56) **References Cited**

U.S. PATENT DOCUMENTS

D332,181 S *	1/1993	Sacco	D6/356
D535,485 S *	1/2007	Moburg	D6/356
D653,866 S *	2/2012	Wada	D6/356
D655,096 S *	3/2012	Shindou	D6/356
D661,115 S *	6/2012	Wada	D6/356
D665,588 S *	8/2012	Wada	D6/356

8,783,773 B2 *	7/2014	Seibold	B60N 2/22 297/354.1
D711,125 S *	8/2014	Nishida	D6/356
D723,821 S *	3/2015	Kondou	D6/356
D723,823 S *	3/2015	Persson	D6/356
D723,824 S *	3/2015	Persson	D6/356
D724,332 S *	3/2015	Ashley	D6/356
D724,333 S *	3/2015	Ashley	D6/356
D738,127 S *	9/2015	Nishida	D6/356

* cited by examiner

Primary Examiner — Mimosa De

(74) *Attorney, Agent, or Firm* — Marshall, Gerstein & Borun LLP

(57) **CLAIM**

The ornamental design for a seat, as shown and described.

DESCRIPTION

FIG. 1 is a perspective view of a first embodiment showing of a seat.

FIG. 2 is a top view of the seat.

FIG. 3 is a bottom view of the seat.

FIG. 4 is a front view of the seat.

FIG. 5 is a back view of the seat.

FIG. 6 is a left-side view of the seat.

FIG. 7 is a right-side view of the seat.

FIG. 8 is a perspective view of a second embodiment showing of a seat.

FIG. 9 is a top view of the seat.

FIG. 10 is a bottom view of the seat.

FIG. 11 is a front view of the seat.

FIG. 12 is a back view of the seat.

FIG. 13 is a left-side view of the seat; and,

FIG. 14 is a right-side view of the seat.

The broken lines seen in FIGS. 8-14 represent stitching. The broken lines showing of the JCB trademarks on the front and right side of the seat are not part of the claimed design.

1 Claim, 14 Drawing Sheets

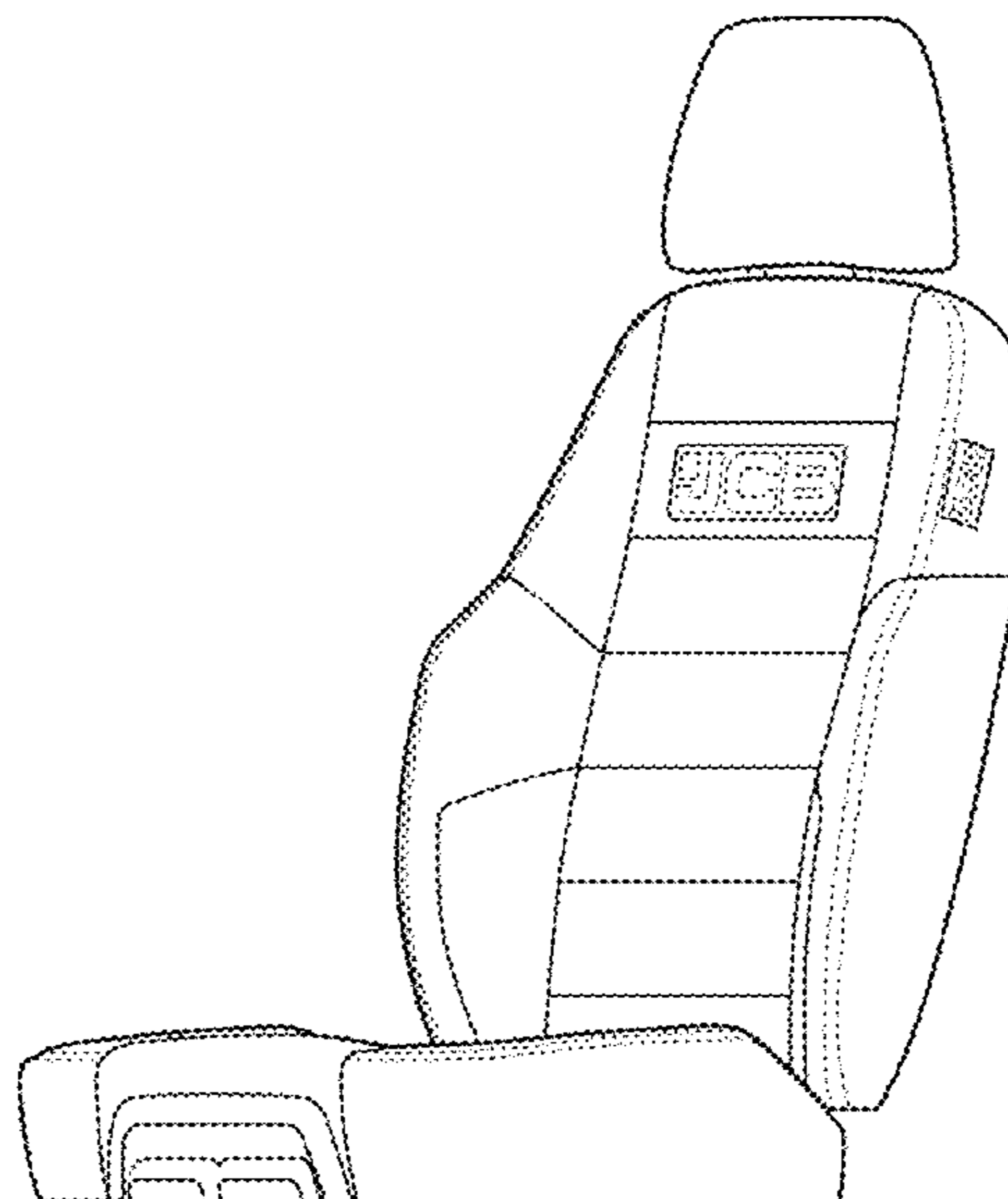
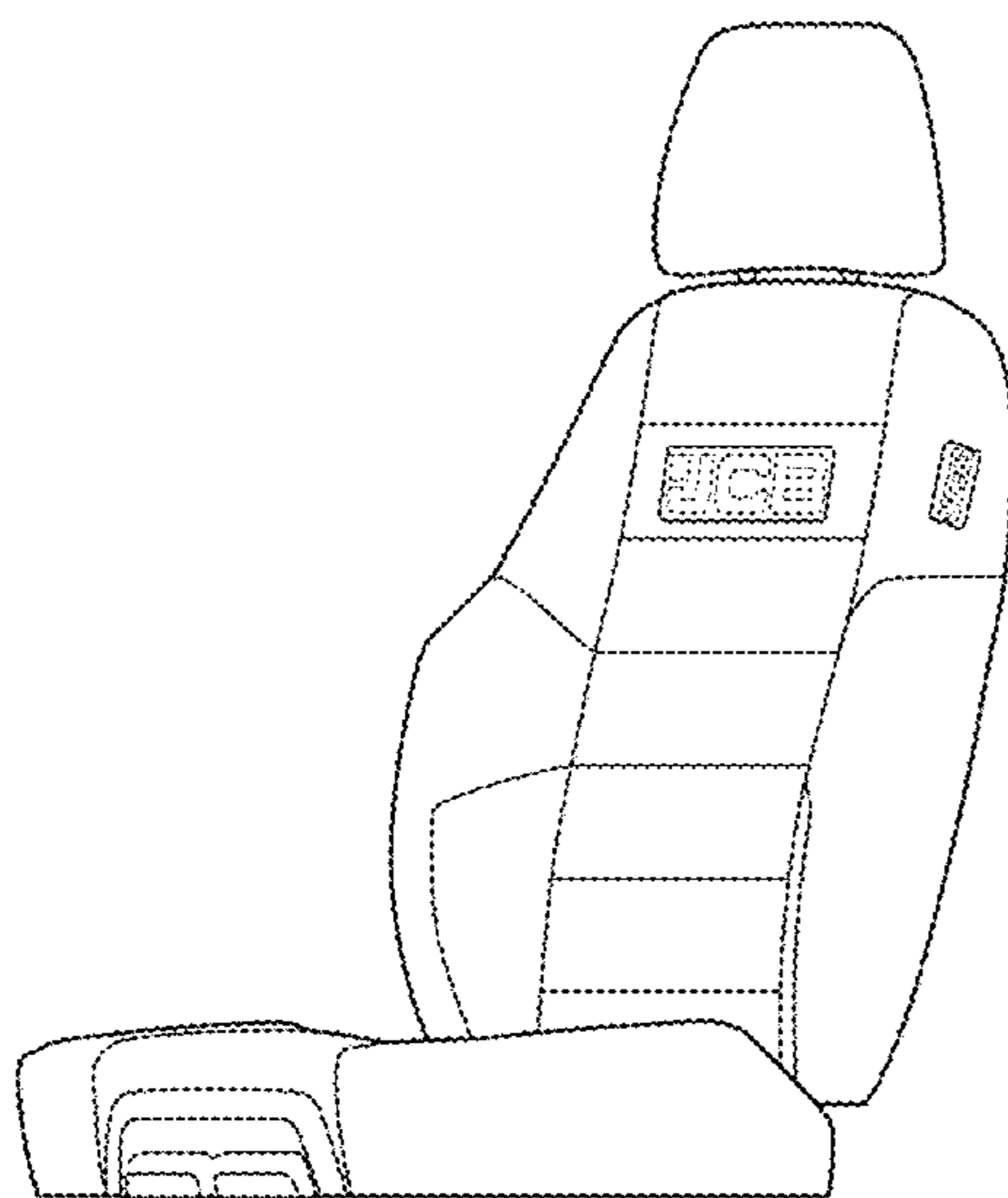

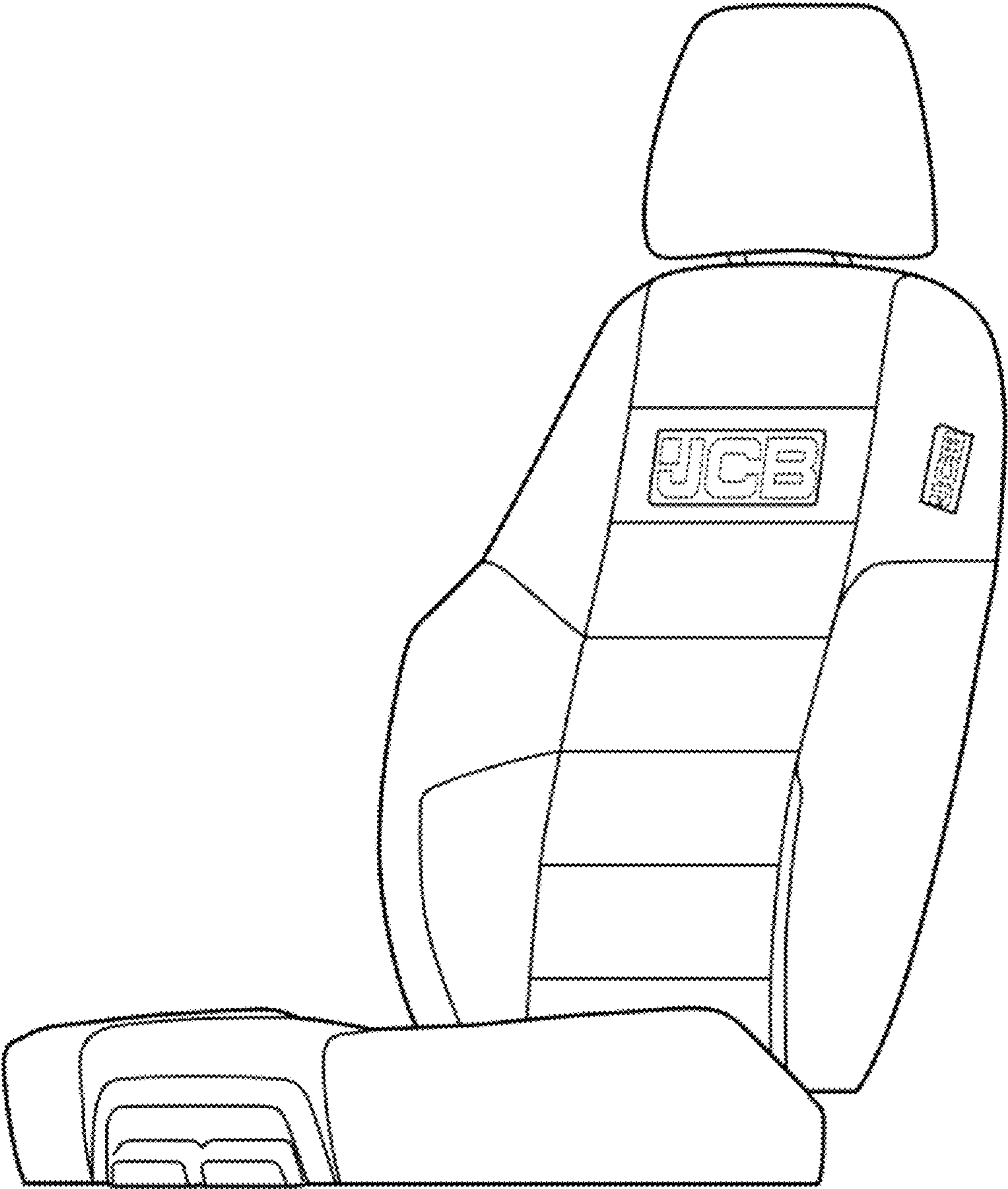

Fig. 1

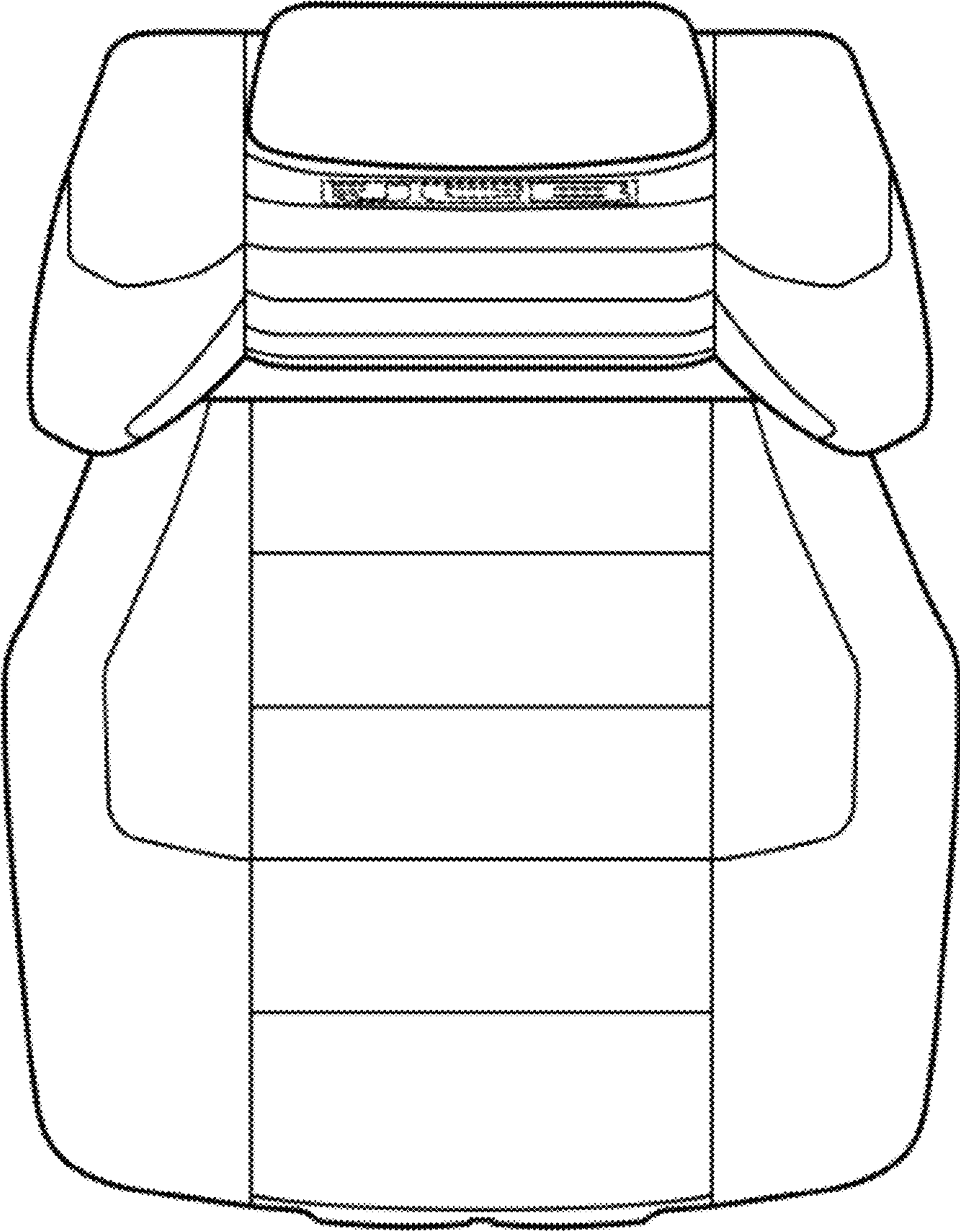

Fig. 2

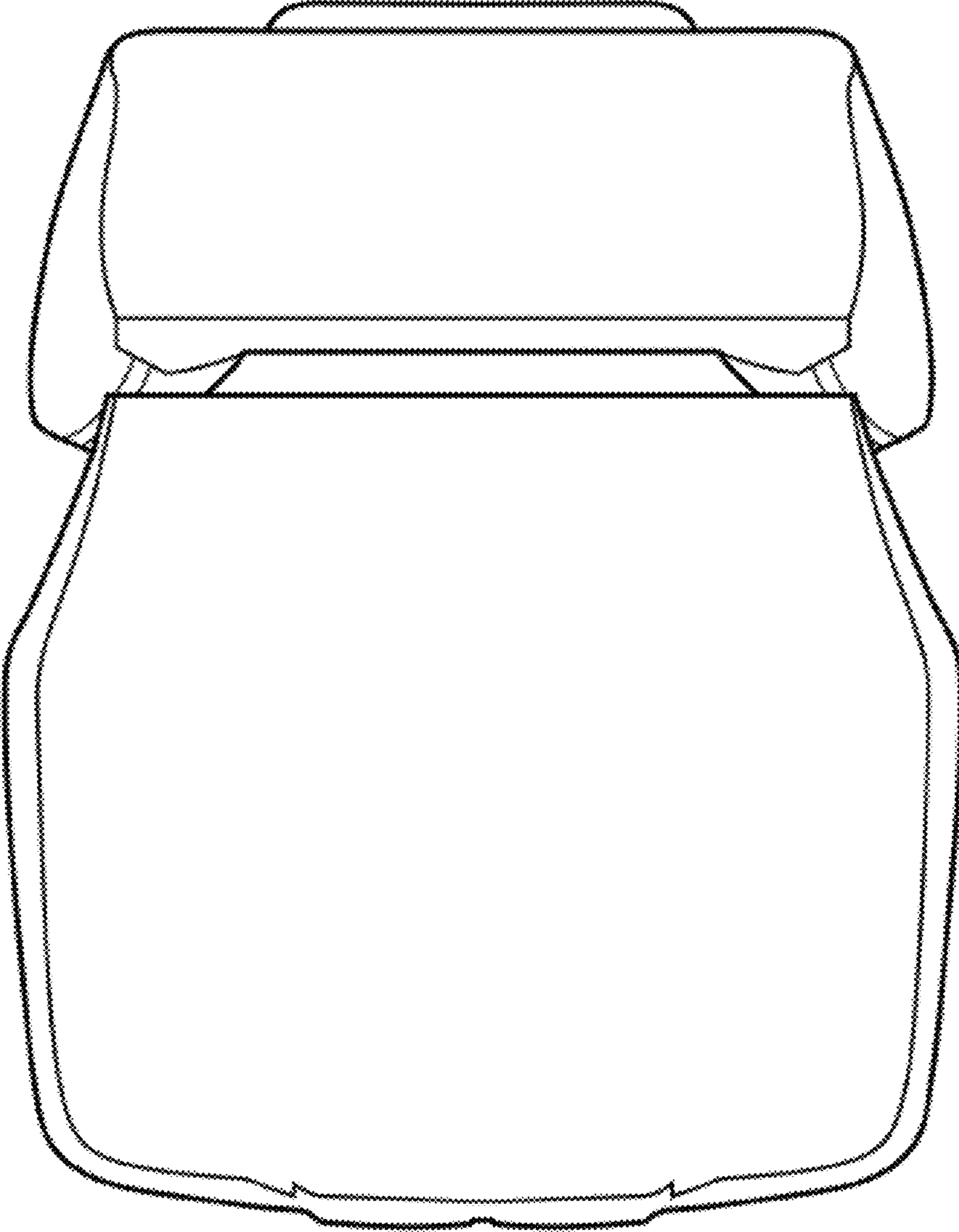

Fig. 3

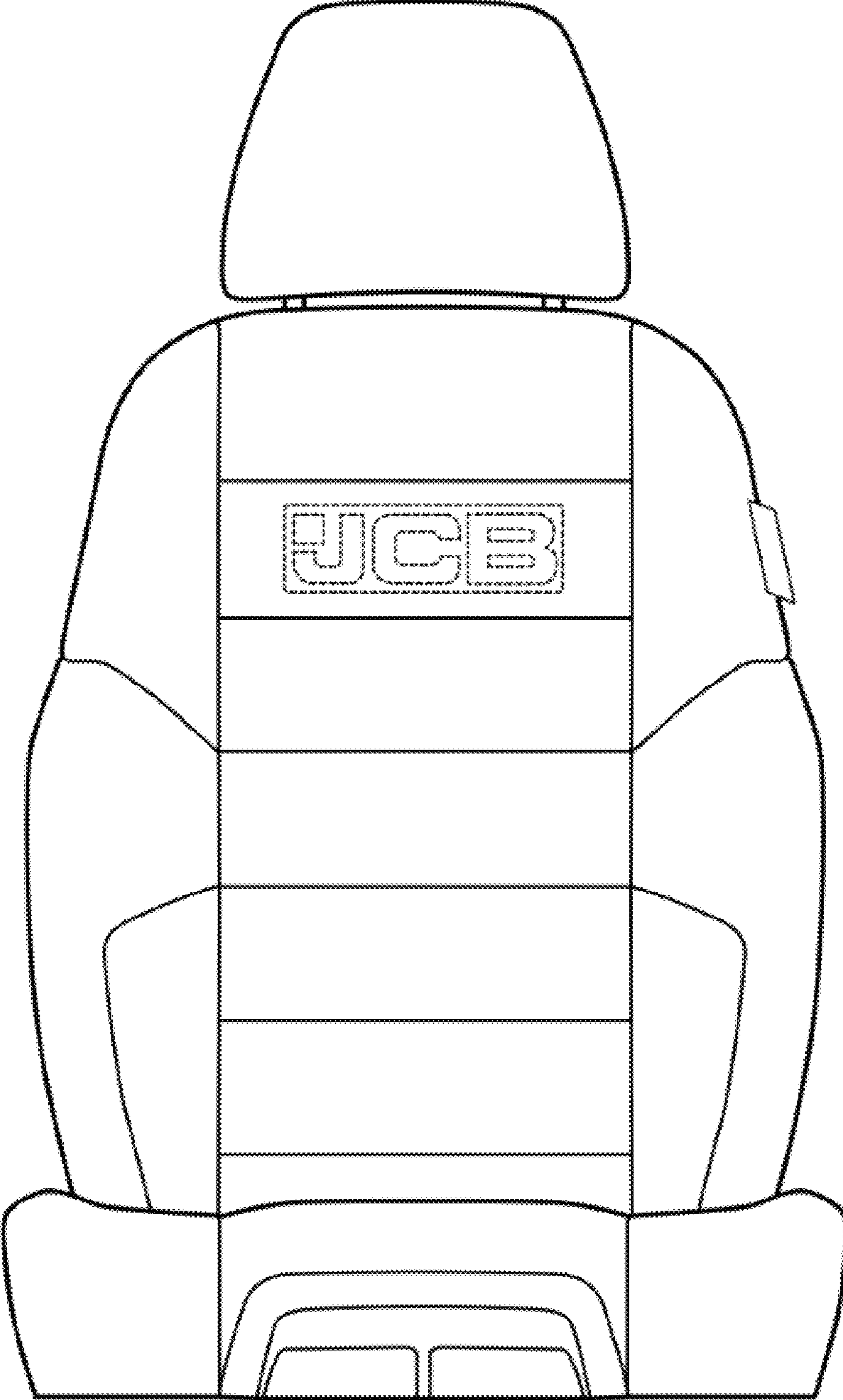

Fig. 4

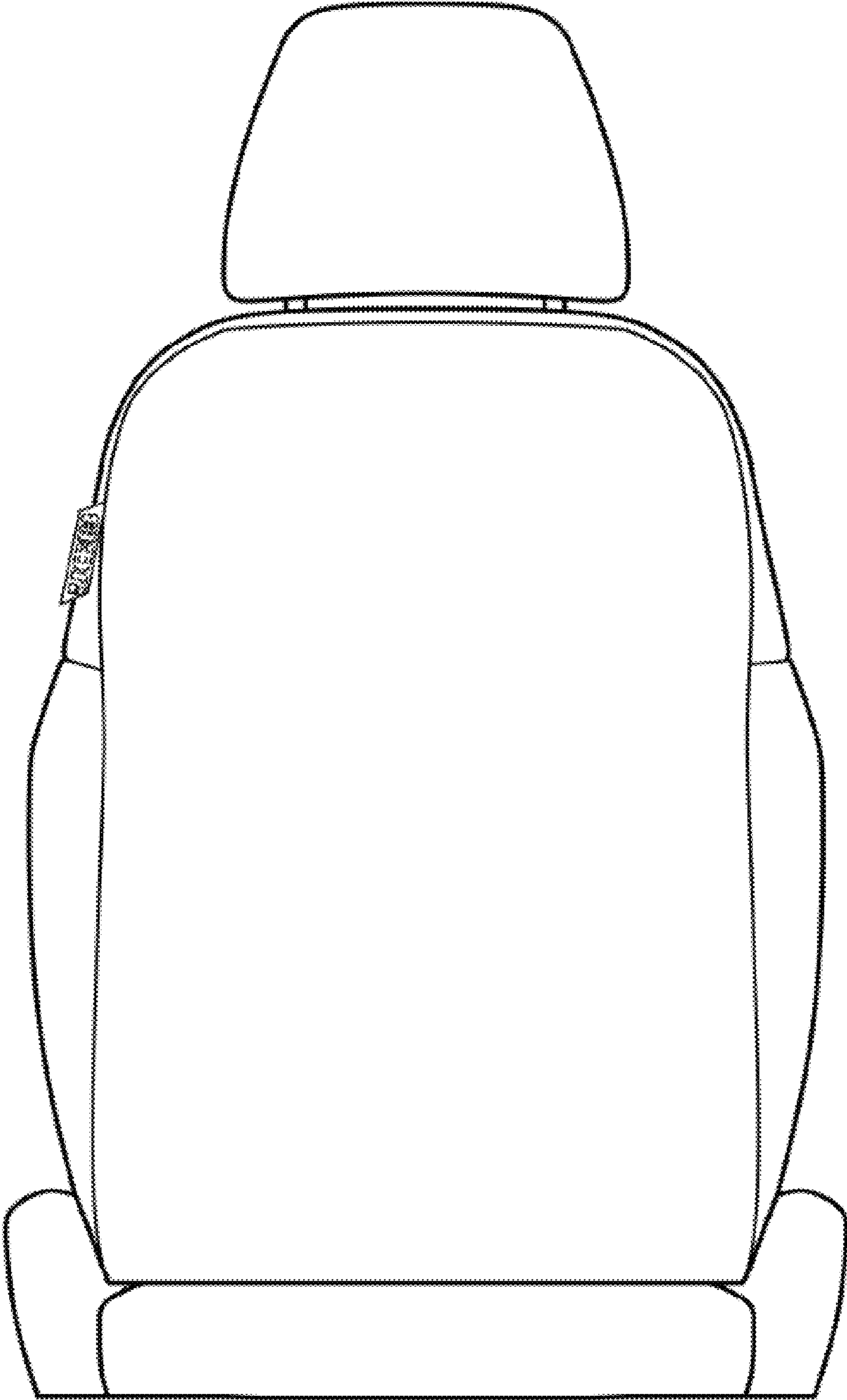

Fig. 5

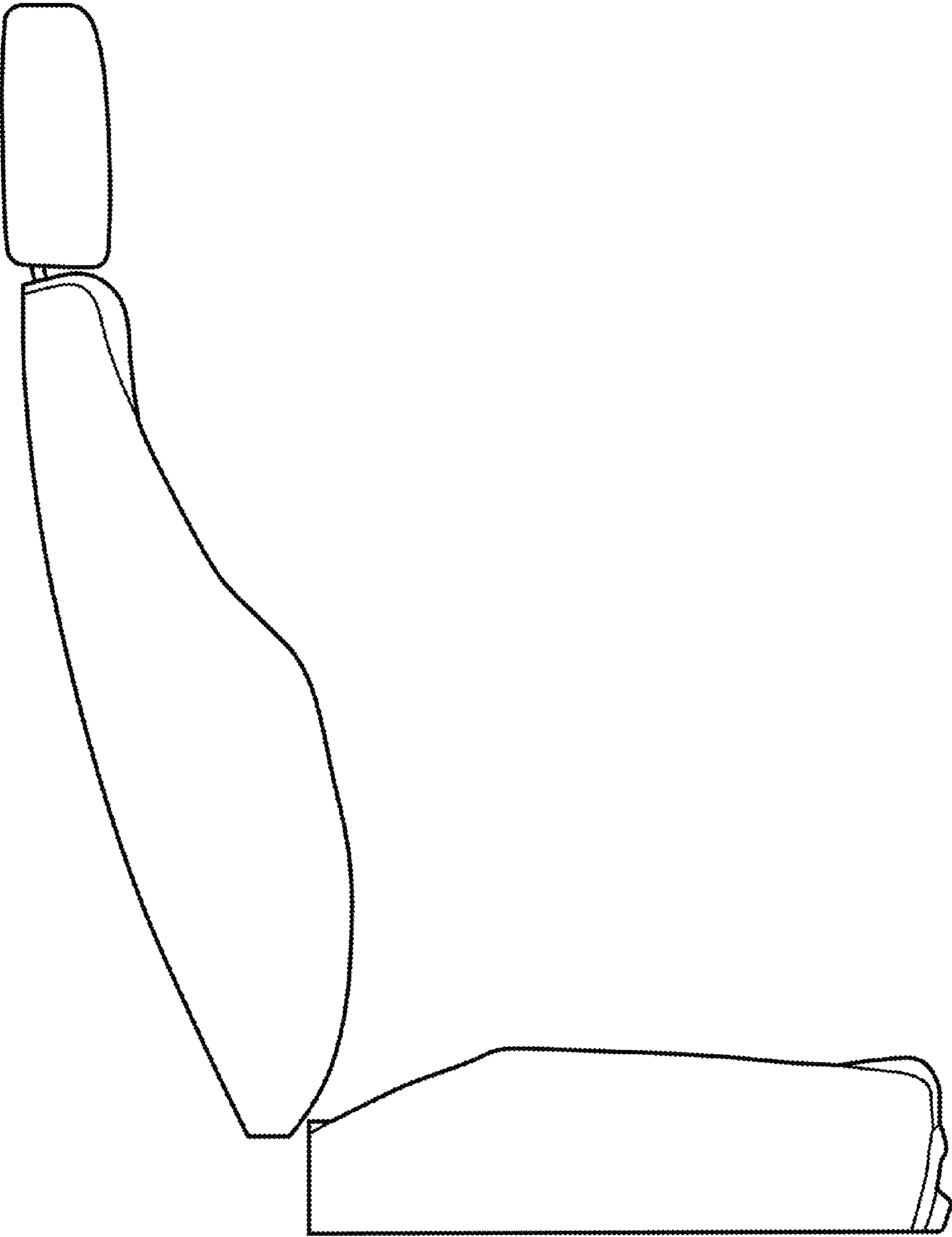

Fig. 6

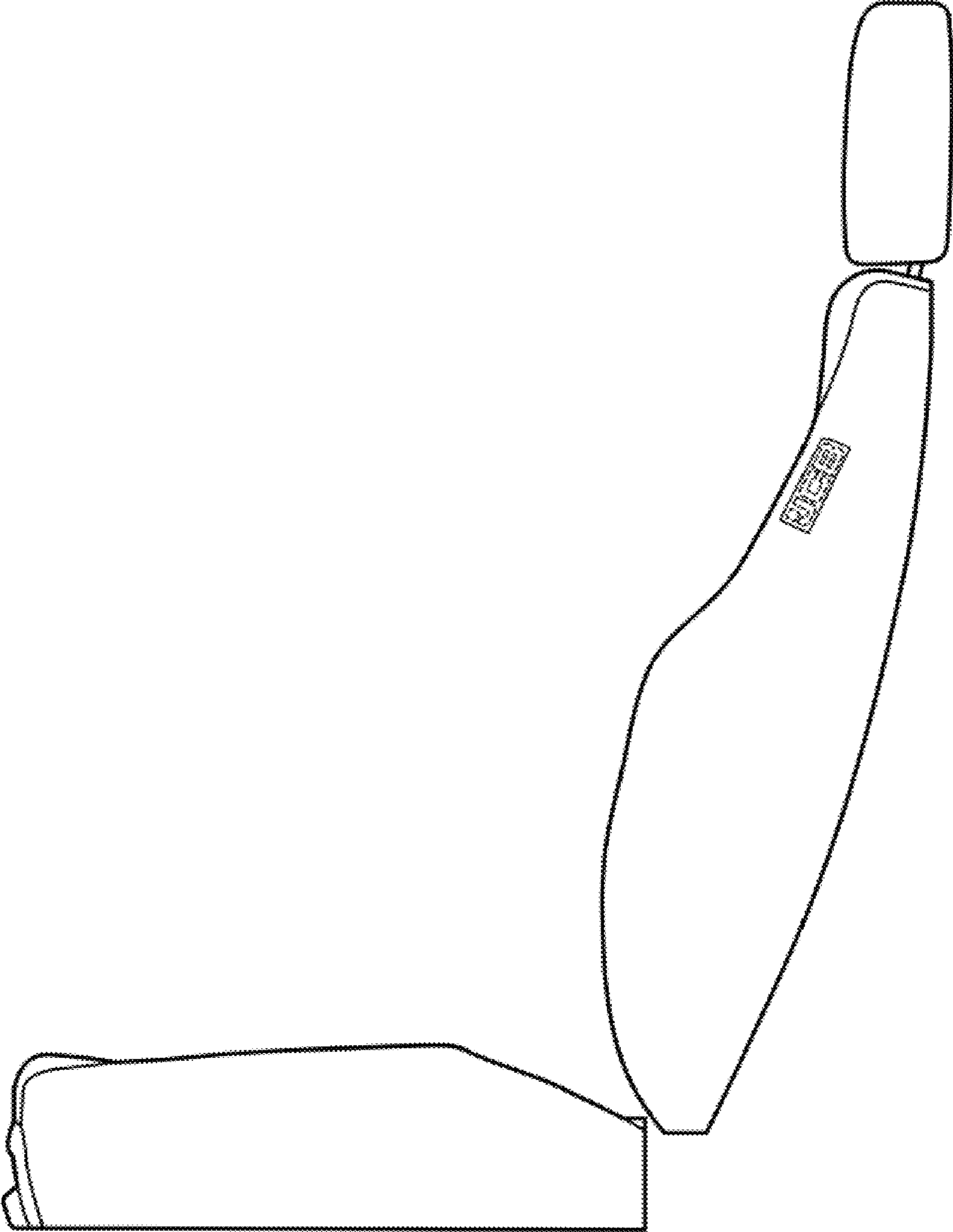

Fig. 7

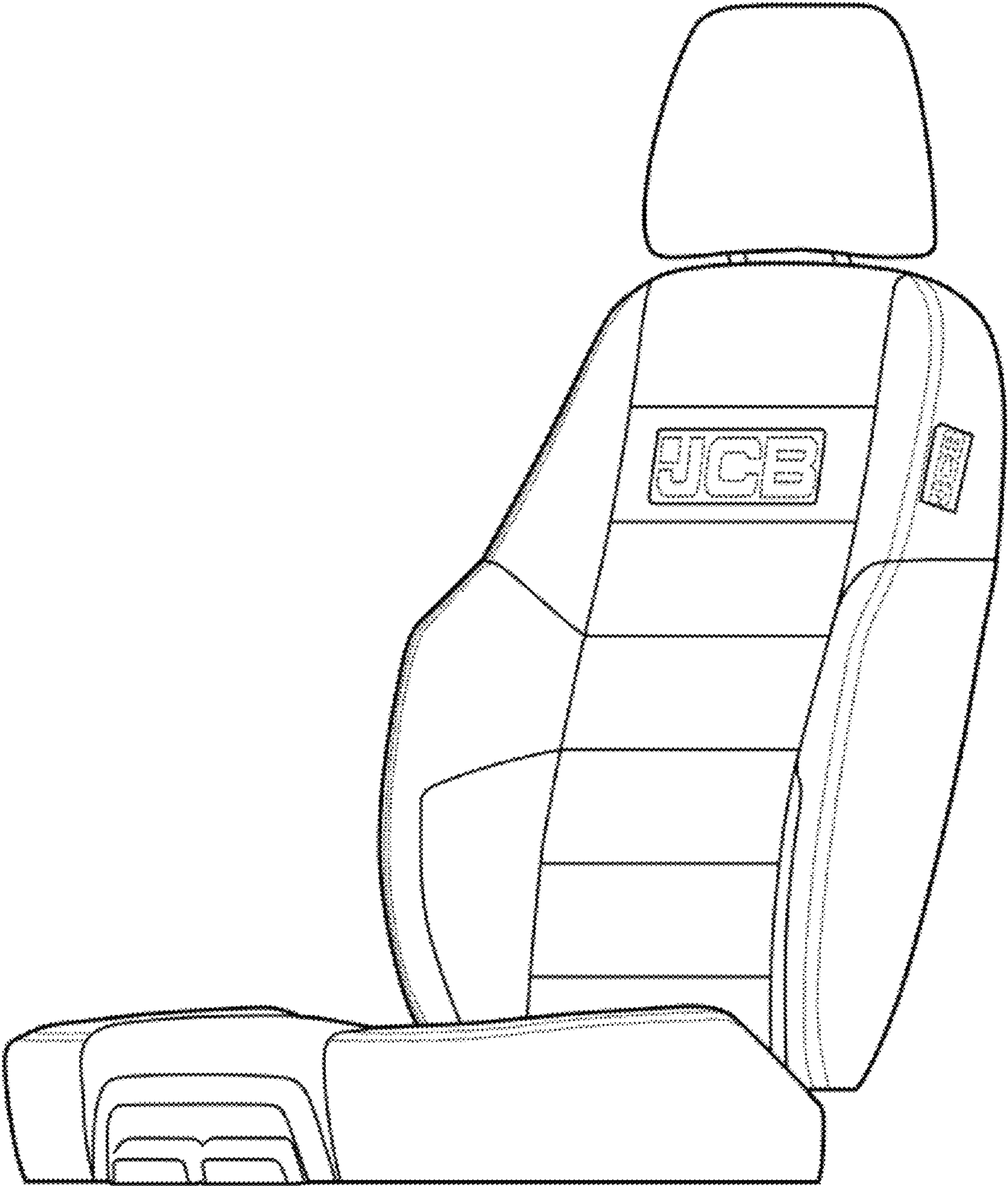

Fig. 8

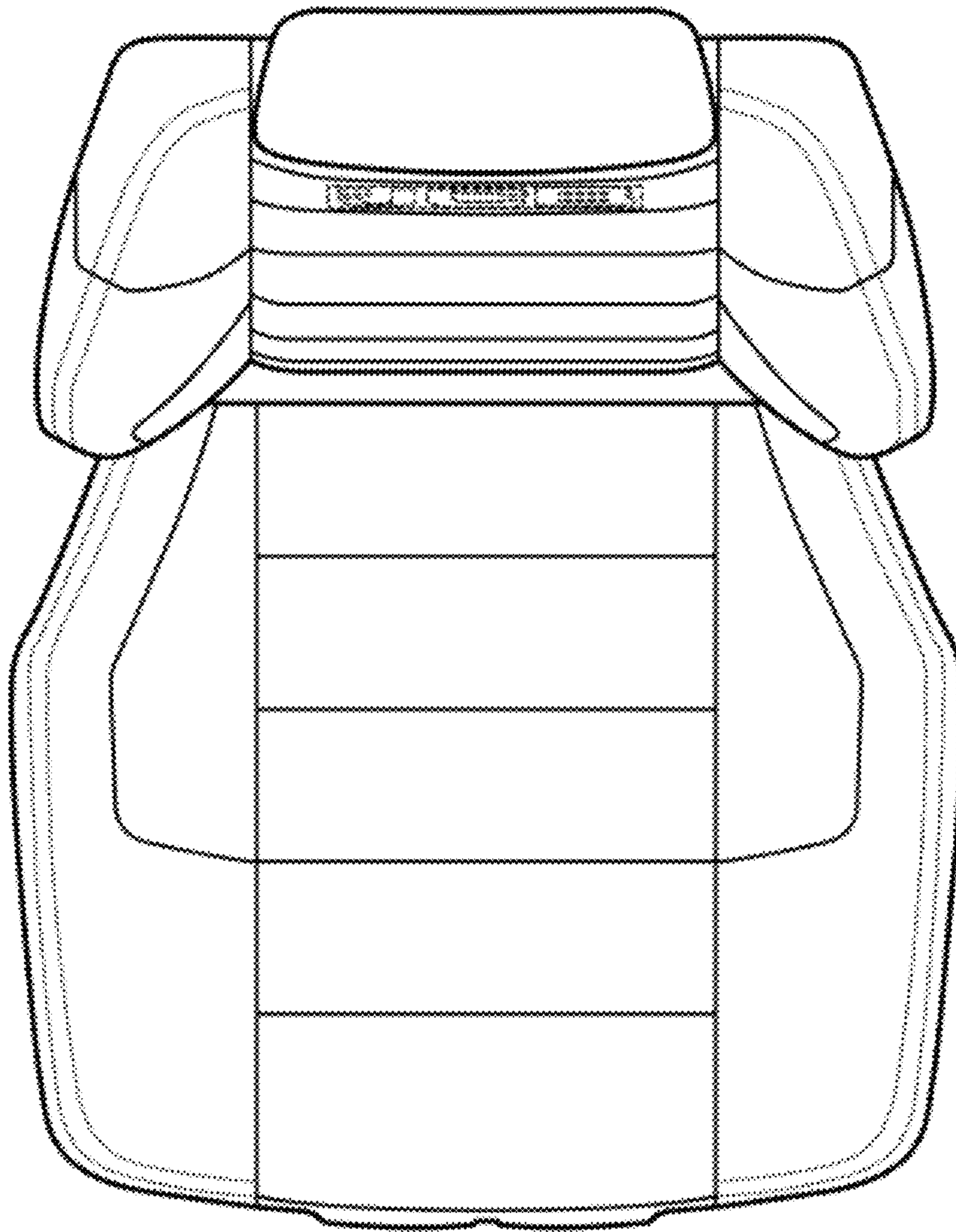

Fig. 9

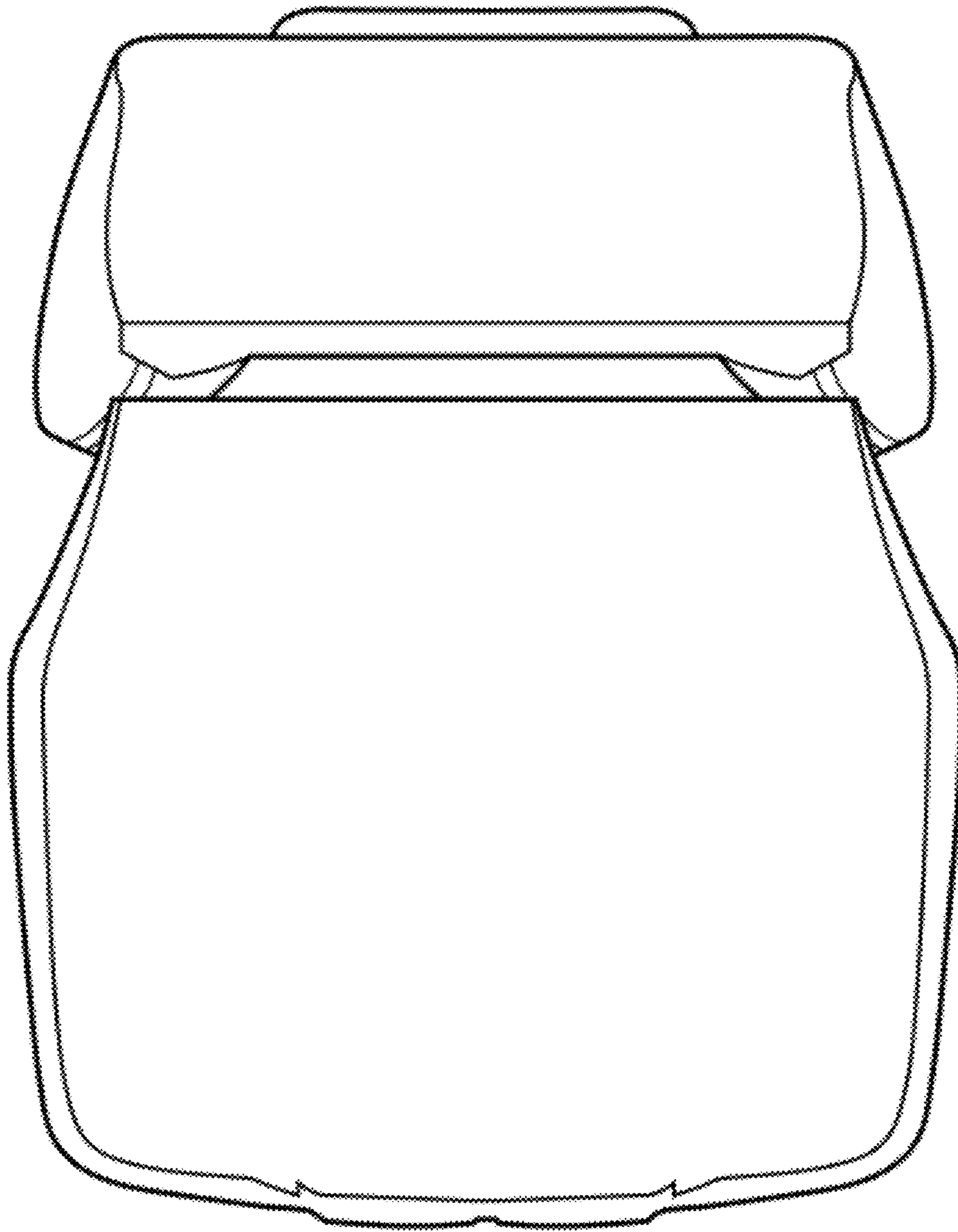

Fig. 10

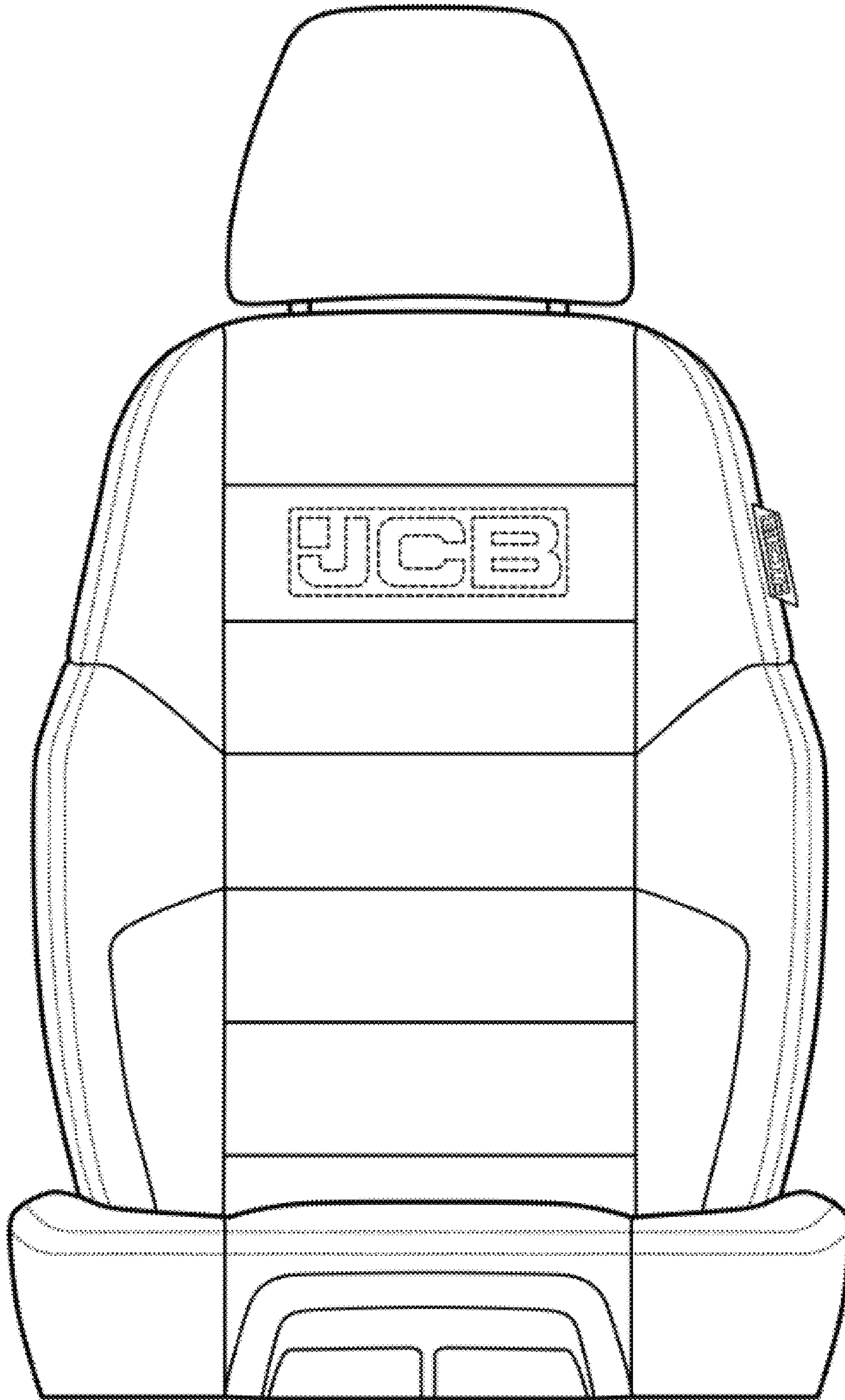

Fig. 11

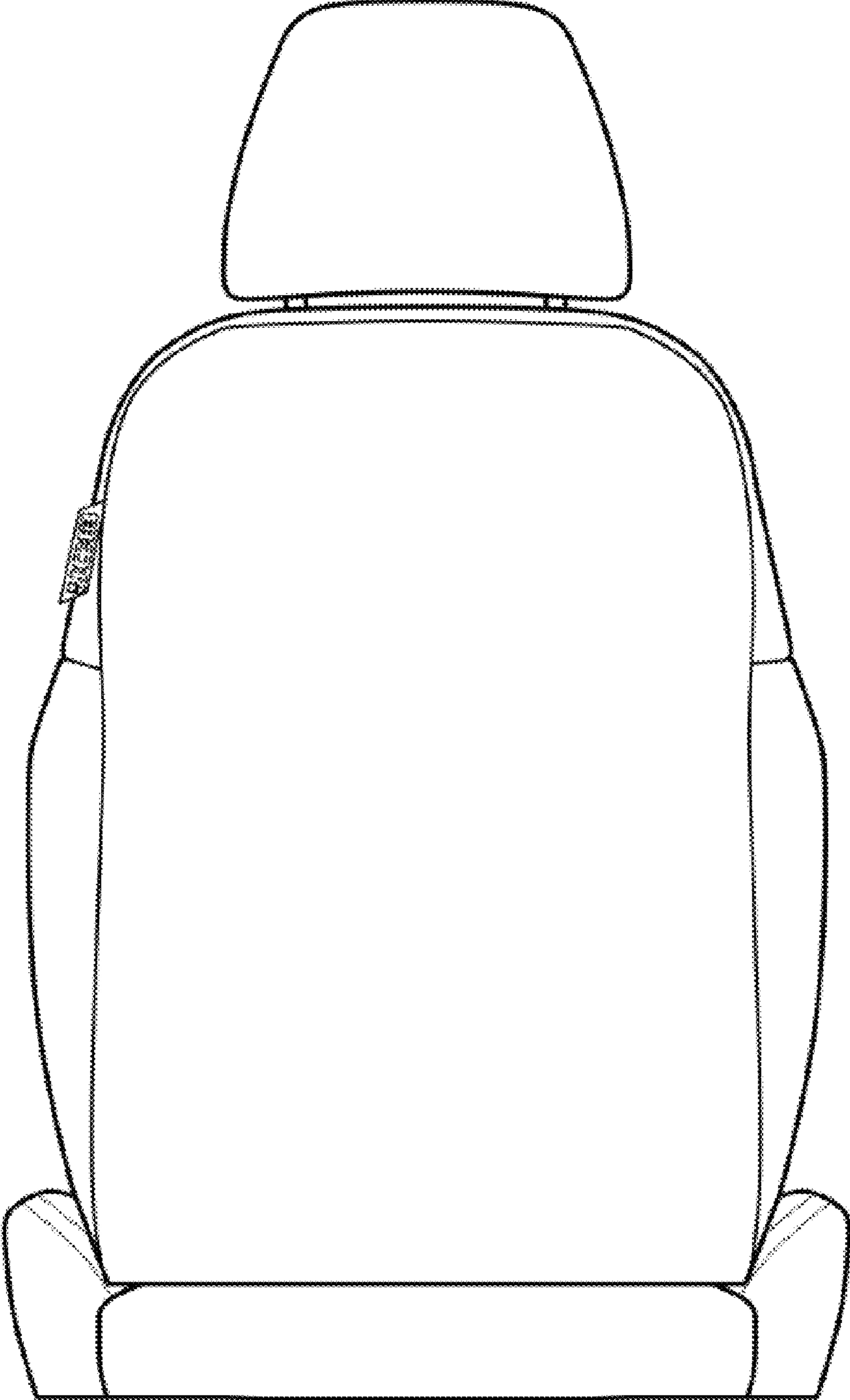

Fig. 12

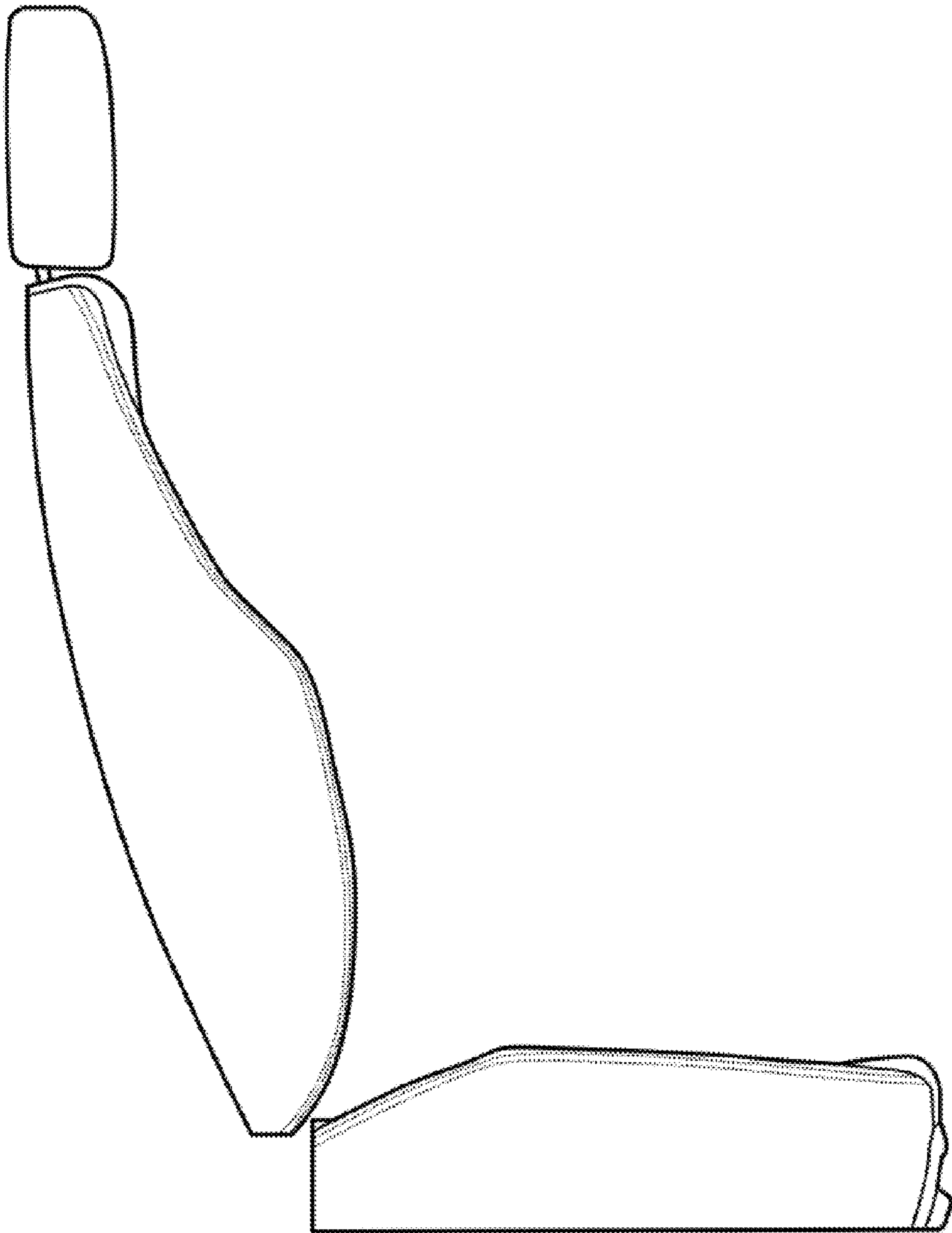

Fig. 13

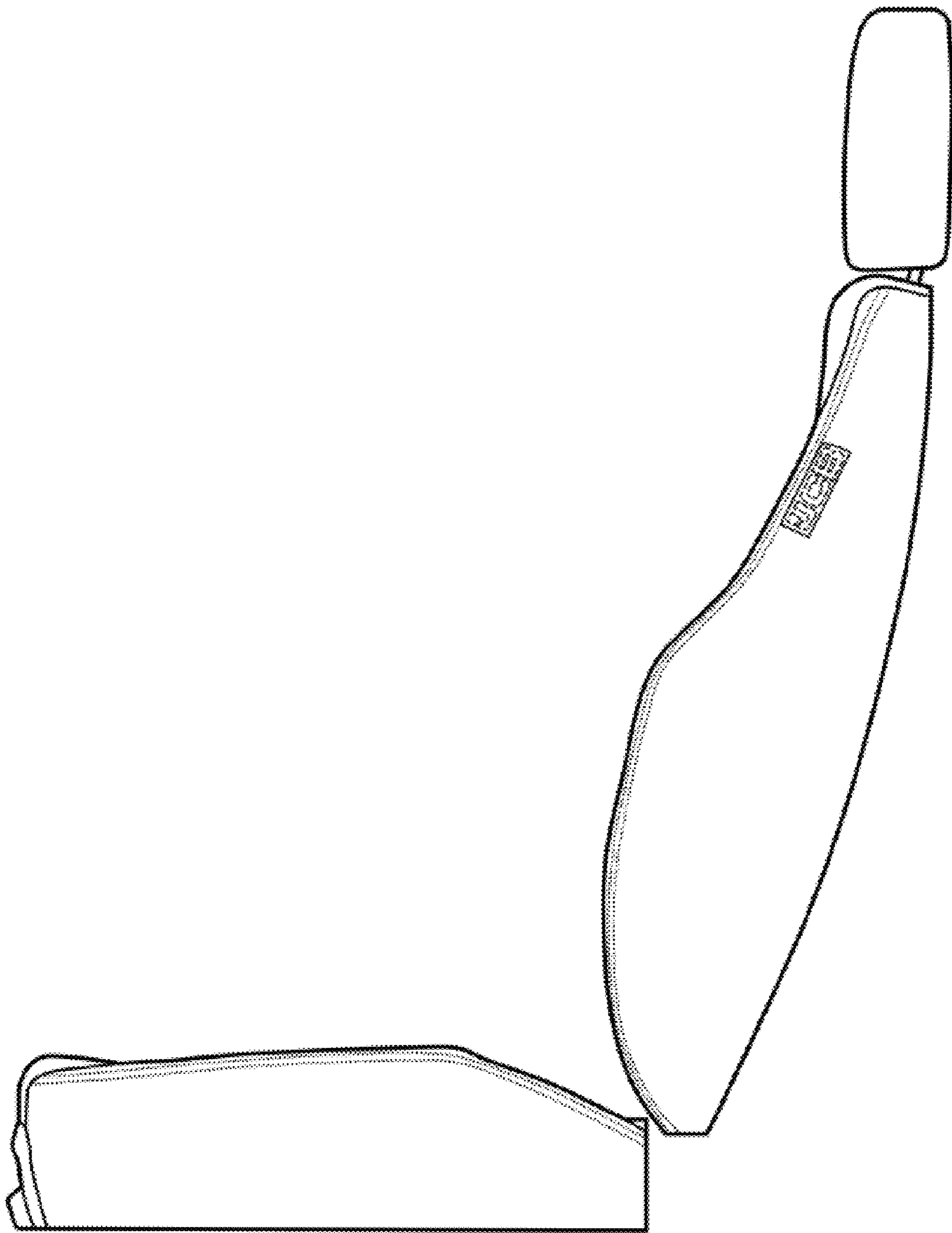

Fig. 14