



US00D749204S

(12) **United States Design Patent**
Breneman et al.

(10) **Patent No.:** **US D749,204 S**
(45) **Date of Patent:** **** Feb. 9, 2016**

- (54) **UNDERCABINET VENT HOOD**
- (71) Applicant: **Whirlpool Corporation**, Benton Harbor, MI (US)
- (72) Inventors: **Samuel B. Breneman**, St. Joseph, MI (US); **Jason Scott Lind**, Benton Harbor, MI (US); **Casey L. McCuan**, Saugatuk, MI (US)
- (73) Assignee: **Whirlpool Corporation**, Benton Harbor, MI (US)
- (**) Term: **14 Years**
- (21) Appl. No.: **29/482,115**
- (22) Filed: **Feb. 14, 2014**
- (51) **LOC (10) Cl.** **23-04**
- (52) **U.S. Cl.**
USPC **D23/372**
- (58) **Field of Classification Search**
USPC D23/370–372, 385–386, 388, 393, 411; 126/299 D, 299 R
CPC F24C 15/2042; F24C 15/2007; F24C 15/205; F24C 15/2064; F24C 15/2071; F24C 15/2078; F24C 15/2085; F24C 15/2092
See application file for complete search history.

(56) **References Cited**

U.S. PATENT DOCUMENTS

D231,615 S	5/1974	Nygaard et al.	
D245,620 S *	8/1977	Berry	D23/371
D245,621 S *	8/1977	Berry	D23/371
D380,823 S	7/1997	LaZar	
5,842,464 A	12/1998	Koch	
D433,495 S *	11/2000	Segers	D23/372
D443,351 S *	6/2001	Strand et al.	D23/372
D444,221 S	6/2001	Strand et al.	
6,240,916 B1 *	6/2001	Huang	126/299 D
D450,379 S	11/2001	Strand et al.	
D455,487 S *	4/2002	Kojima et al.	D23/372

D462,434 S *	9/2002	Kojima	D23/372
6,470,880 B1	10/2002	Chang	
D489,805 S	5/2004	Vetter	
D526,711 S	8/2006	Galeazzi et al.	
D527,088 S	8/2006	Hendrickx	
D528,644 S *	9/2006	Schwamkrug	D23/372
D532,509 S *	11/2006	Cheng	D23/372
D535,009 S	1/2007	Sinur et al.	
D557,397 S	12/2007	Sinur et al.	
D565,718 S *	4/2008	Kudo	D23/372
D575,861 S *	8/2008	Kudo	D23/372
D576,264 S	9/2008	Grobleben	
D580,041 S *	11/2008	Kudo	D23/372
D580,540 S *	11/2008	Kudo	D23/372
D621,022 S	8/2010	Funnell	
2004/0194778 A1 *	10/2004	Yeung	126/299 R

(Continued)

Primary Examiner — Susan Bennett Hattan
Assistant Examiner — Janice Hallmark

(57) **CLAIM**

We claim the ornamental design for an undercabinet vent hood, as shown and described.

DESCRIPTION

FIG. 1 is a top perspective view of an undercabinet vent hood of the present disclosure;
 FIG. 2 is a front elevational view of the undercabinet vent hood of FIG. 1;
 FIG. 3 is a rear elevational view of the undercabinet vent hood of FIG. 1;
 FIG. 4 is a first side elevational view of the undercabinet vent hood of FIG. 1;
 FIG. 5 is a second side elevational view of the undercabinet vent hood of FIG. 1;
 FIG. 6 is a top plan view of the undercabinet vent hood of FIG. 1; and,
 FIG. 7 is a bottom plan view of the undercabinet vent hood of FIG. 1.

The broken lines in the drawings depict environmental subject matter only and form no part of the claimed design.

1 Claim, 5 Drawing Sheets

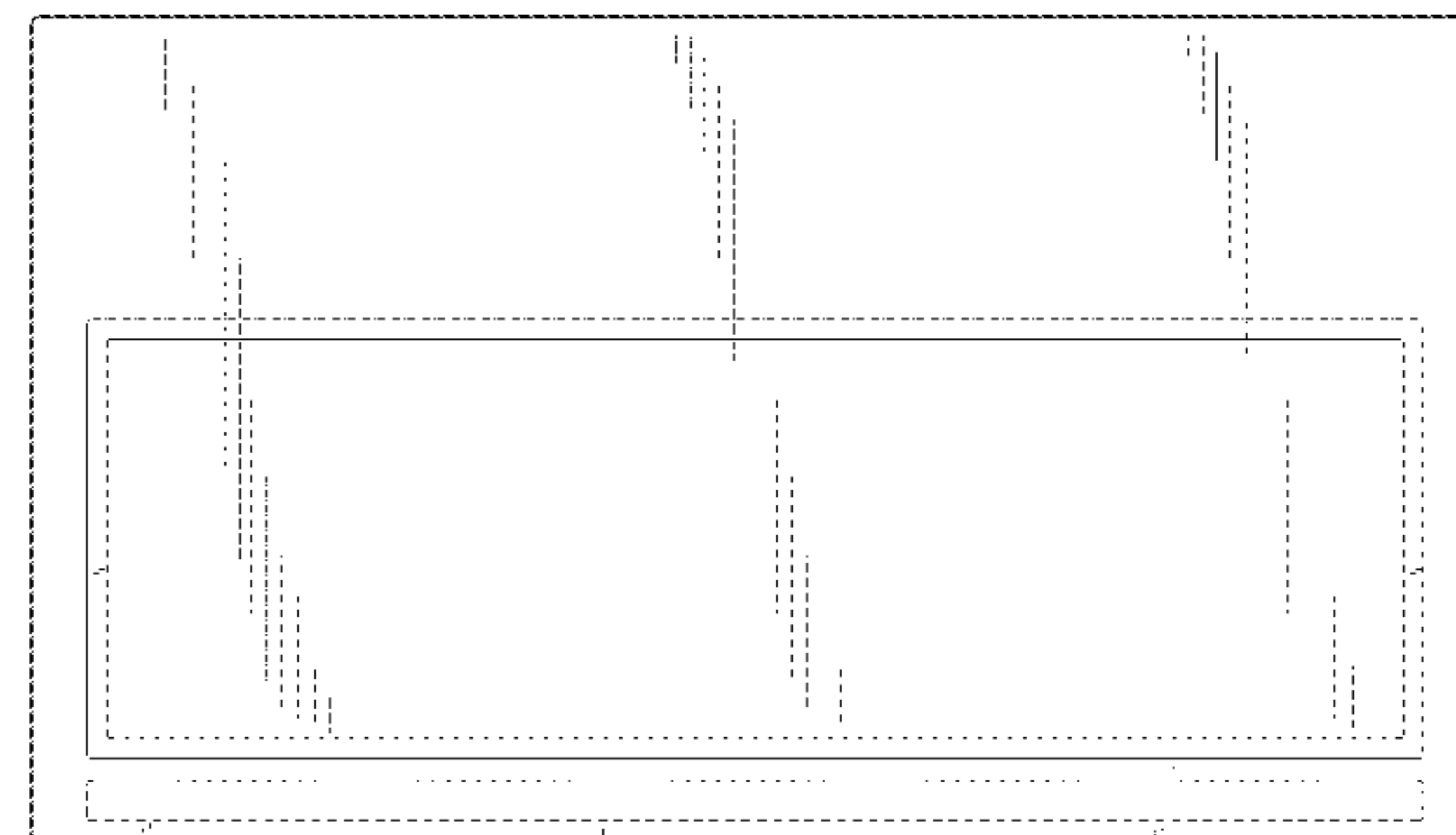
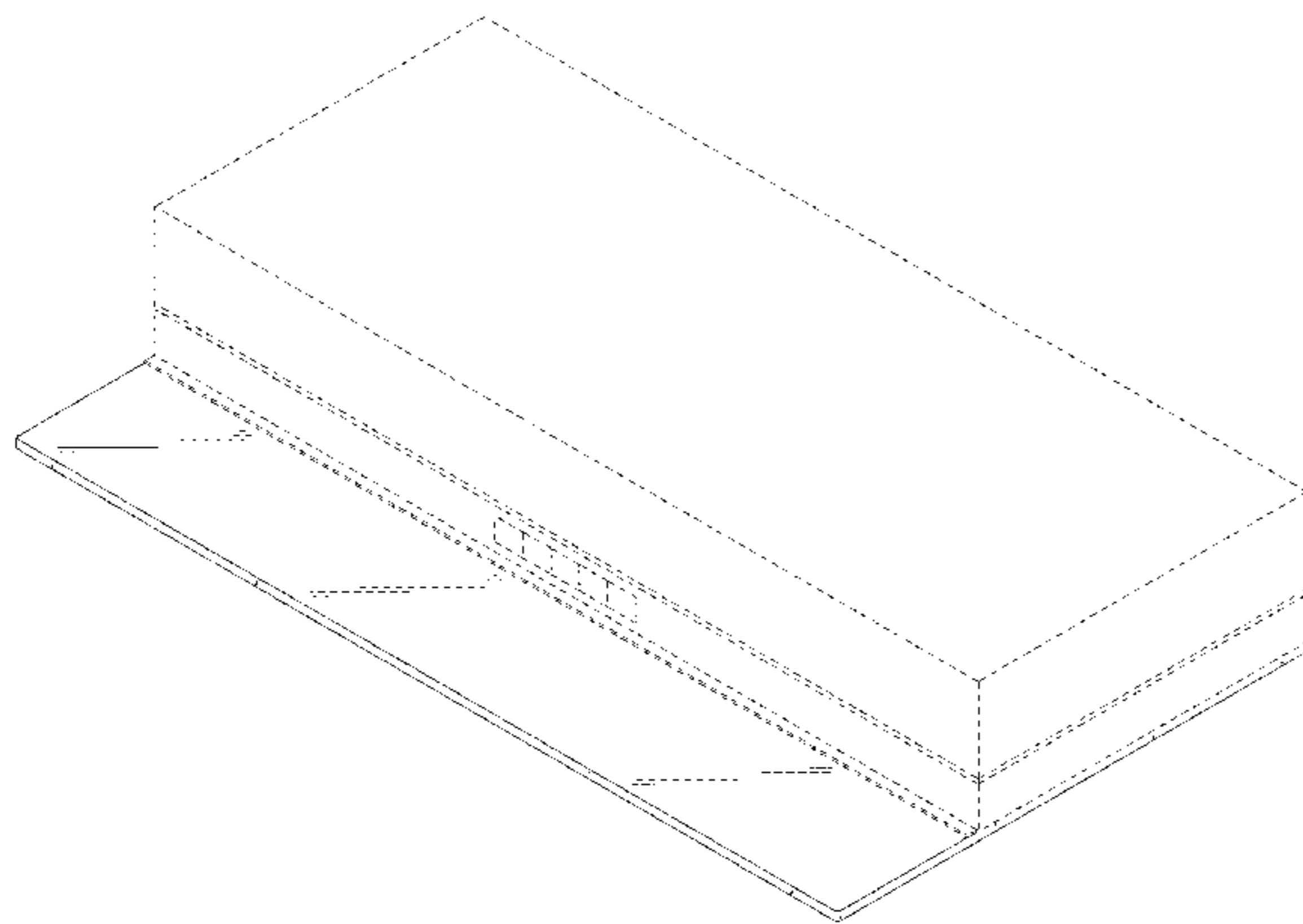

US D749,204 S

Page 2

(56)

References Cited

U.S. PATENT DOCUMENTS

2006/0090746	A1*	5/2006	Lee	126/299 D	
2006/0249141	A1	11/2006	Sinur et al.		
2008/0302352	A1*	12/2008	Pearce et al.	126/299 R	
2010/0000512	A1	1/2010	Huang		
2010/0095949	A1	4/2010	Huang		
2012/0255267	A1*	10/2012	Ehrensberger et al.	55/385.7	

* cited by examiner

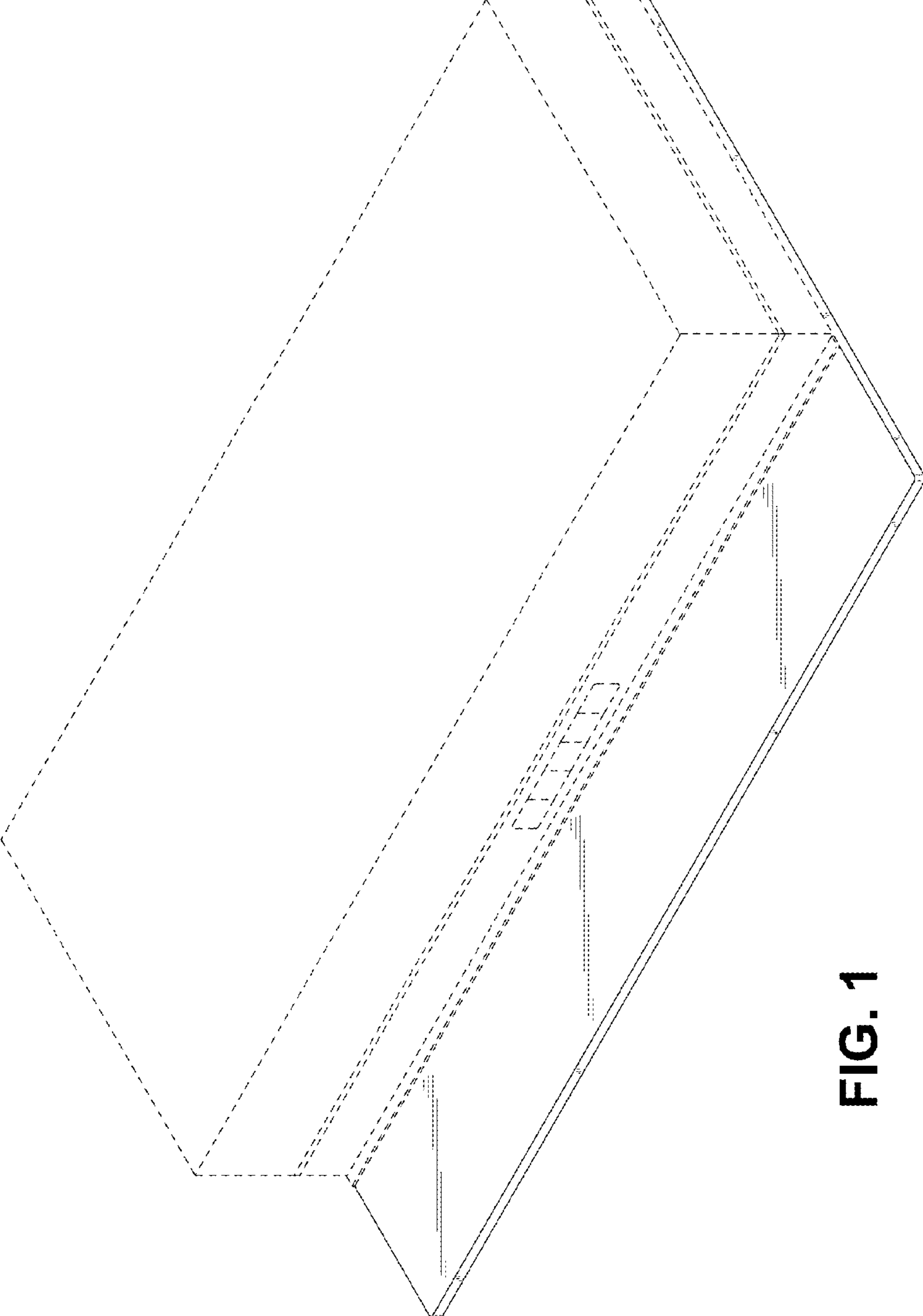

FIG. 1

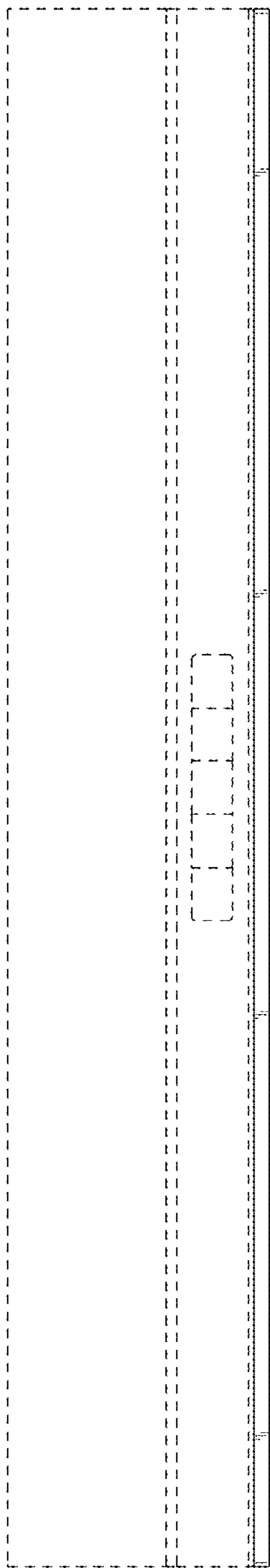

FIG. 2

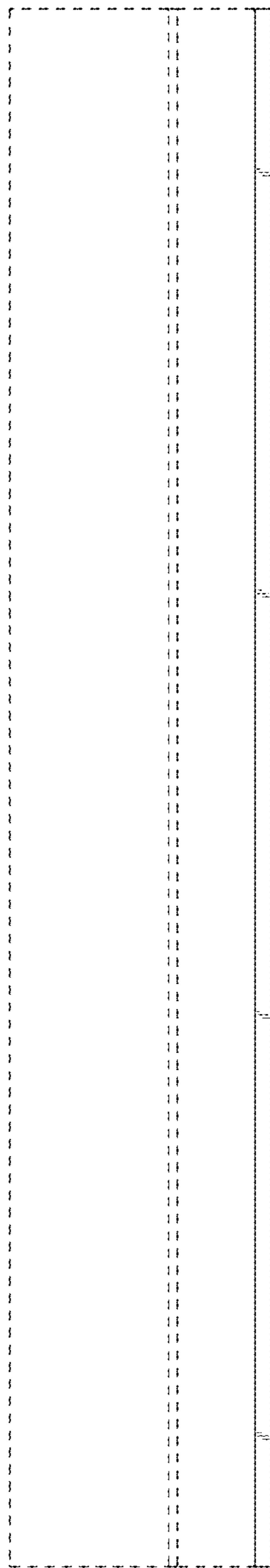

FIG. 3

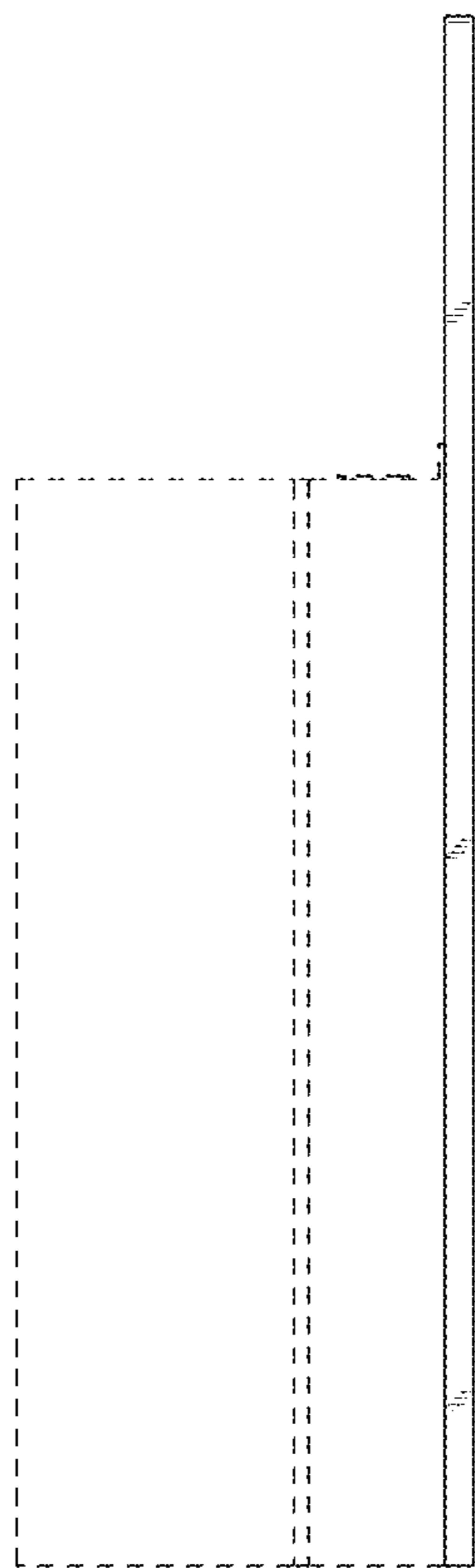

FIG. 4

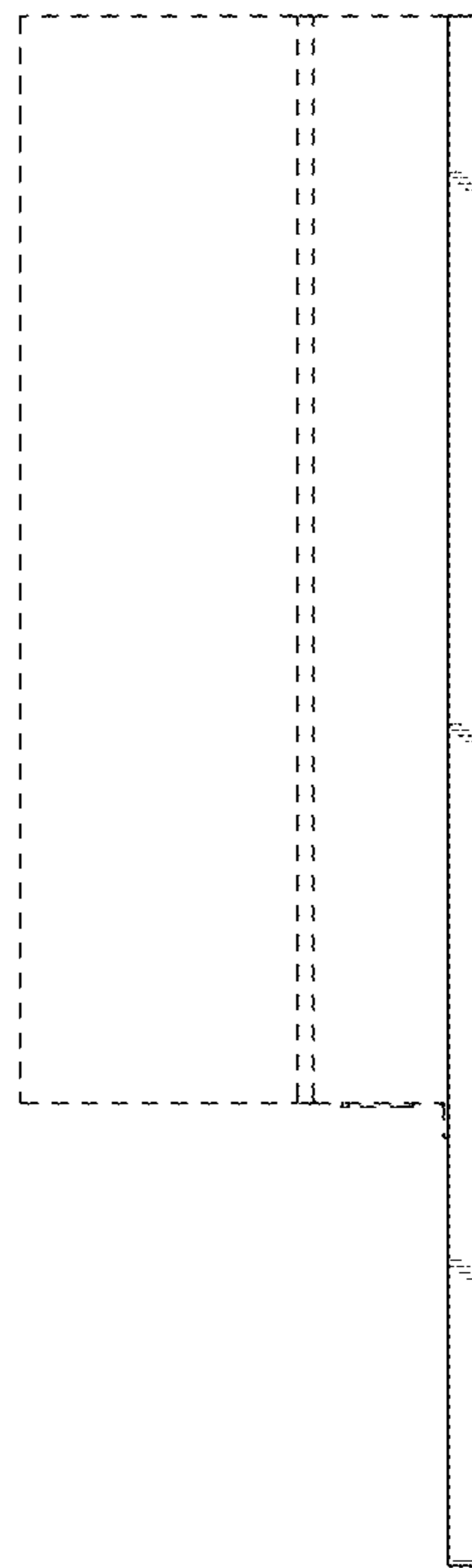

FIG. 5

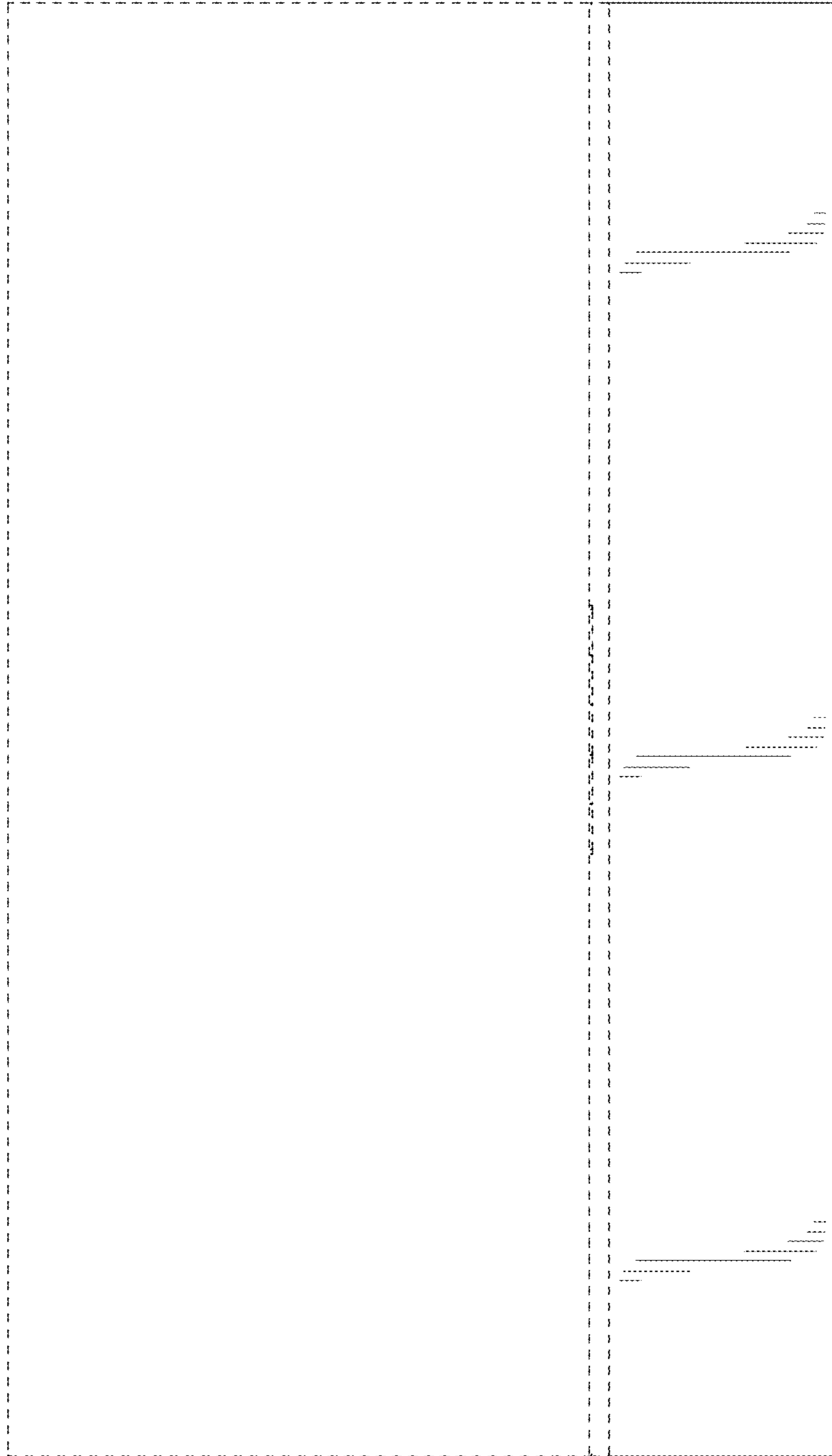

FIG. 6

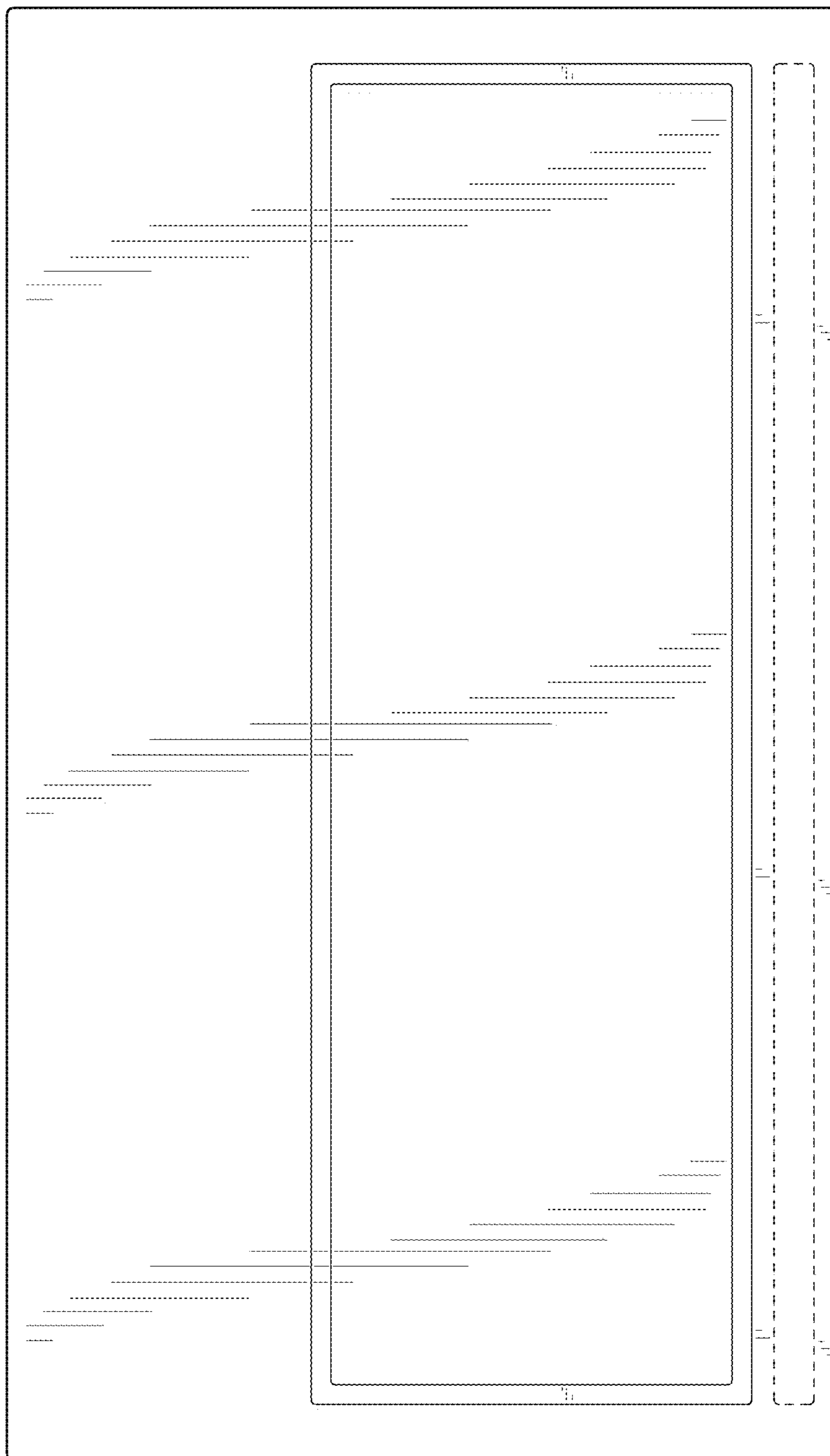

FIG. 7