



US00D749152S

(12) **United States Design Patent**
McConnell

(10) **Patent No.:** **US D749,152 S**
(45) **Date of Patent:** **** Feb. 9, 2016**

(54) **APPLIANCE DOOR INTERIOR WITH MULTI-COLOR**

(71) Applicant: **Whirlpool Corporation**, Benton Harbor, MI (US)

(72) Inventor: **Jessica McConnell**, St. Joseph, MI (US)

(73) Assignee: **Whirlpool Corporation**, Benton Harbor, MI (US)

(**) Term: **14 Years**

(21) Appl. No.: **29/450,217**

(22) Filed: **Mar. 15, 2013**

(51) **LOC (10) Cl.** **15-07**

(52) **U.S. Cl.**
USPC **D15/89**

(58) **Field of Classification Search**

USPC D15/79, 81, 84, 85, 86, 88, 89, 91
CPC F25D 2323/02; F25D 2323/021; F25D 2317/06; F25D 2317/062; F25D 2323/121; F25D 2323/122; F25D 2331/806; F25D 2400/36; F25D 13/02; F25D 13/04; F25D 11/02; F25D 11/025

See application file for complete search history.

(56) **References Cited**

U.S. PATENT DOCUMENTS

D508,249 S *	8/2005	Seok et al.	D15/86
D511,177 S *	11/2005	Jackovin et al.	D15/89
D511,179 S *	11/2005	Tunzi	D15/89
D518,832 S *	4/2006	Park et al.	D15/85
D616,001 S	5/2010	Yang et al.		
D629,819 S *	12/2010	Placke et al.	D15/89
D639,315 S *	6/2011	Yang et al.	D15/85

(Continued)

Primary Examiner — Ian Simmons

Assistant Examiner — Khawaja Anwar

(57) **CLAIM**

I claim the ornamental design for a appliance door interior with multi-color, as shown.

DESCRIPTION

FIG. 1 is a perspective view of the outside of a appliance door interior with multi-color, showing my new design;

FIG. 2 is a front elevation view thereof;

FIG. 3 is a right side elevation view thereof;

FIG. 4 is a top plan view thereof;

FIG. 5 is a bottom plan view thereof;

FIG. 6 is a front perspective view of a appliance door interior with multi-color in a closed position with a partially opened unclaimed interior;

FIG. 7 is a front elevation view thereof;

FIG. 8 is a perspective view of the right side of the partially opened unclaimed interior;

FIG. 9 is a perspective view of the left side of the partially opened unclaimed interior;

FIG. 10 is a perspective view of an isolated element of the partially opened unclaimed interior;

FIG. 11 is a front elevation view thereof;

FIG. 12 is a perspective view of another isolated element of the partially opened unclaimed interior;

FIG. 13 is a front elevation view thereof;

FIG. 14 is a front perspective view of a appliance door interior with multi-color in an open position with a partially opened unclaimed interior;

FIG. 15 is a top perspective view of a appliance door interior with multi-color in a partially opened position;

FIG. 16 is a top perspective view thereof in a complete open position; and,

FIG. 17 is an isolated front-perspective view thereof.

The broken lines in the figures illustrate the environment and form no part of the claimed design.

The stipple-filled portions within the dot-dash-dot-dash lines on the freezer compartment drawer represent the color gray, where the gray color has the following color characteristics according to the CIELAB System:

Illuminant A L 59.21 a -0.76 b-1.78

Illuminant F2 L59.23 a-0.32 b-1.72

1 Claim, 16 Drawing Sheets

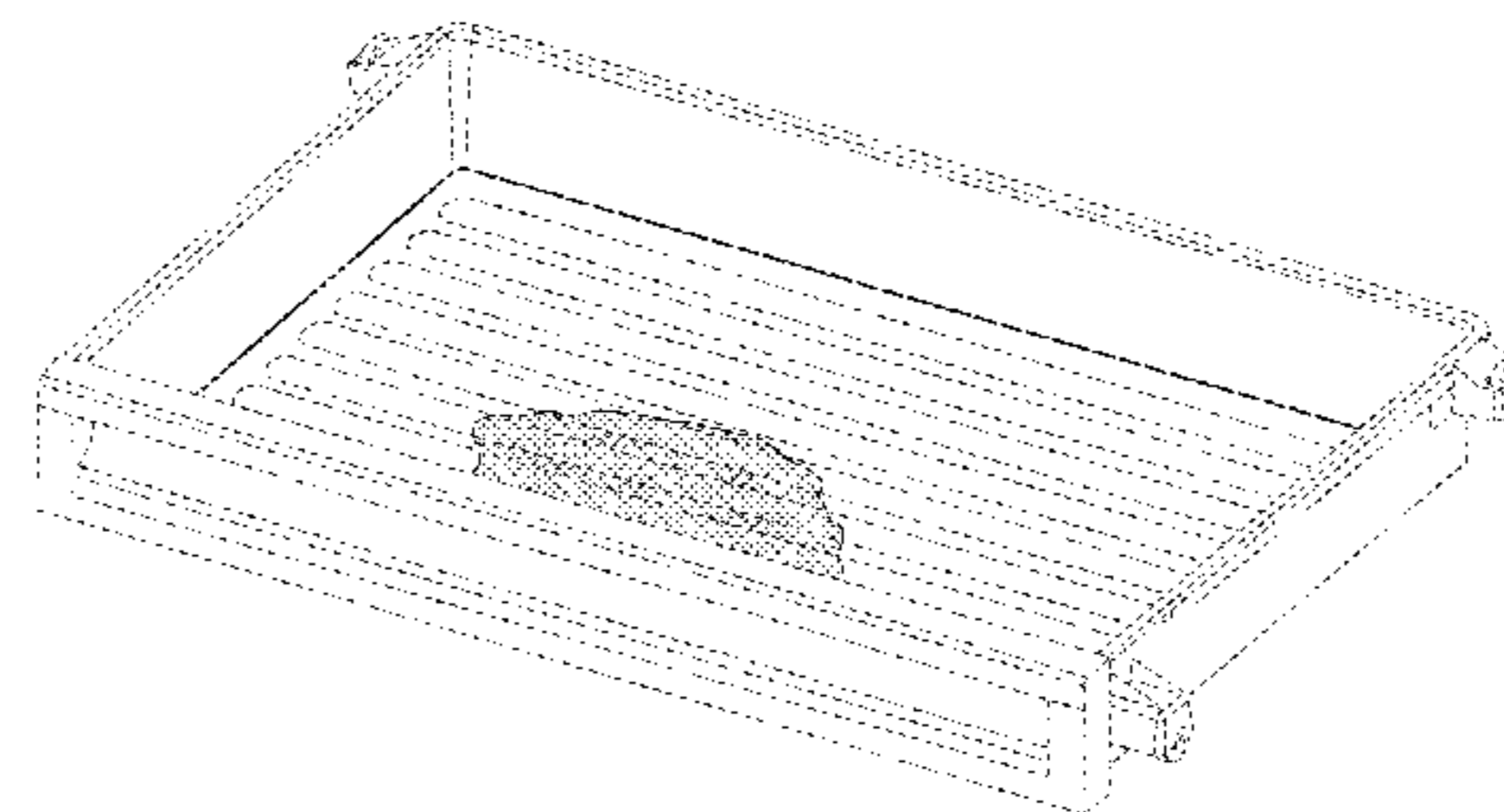
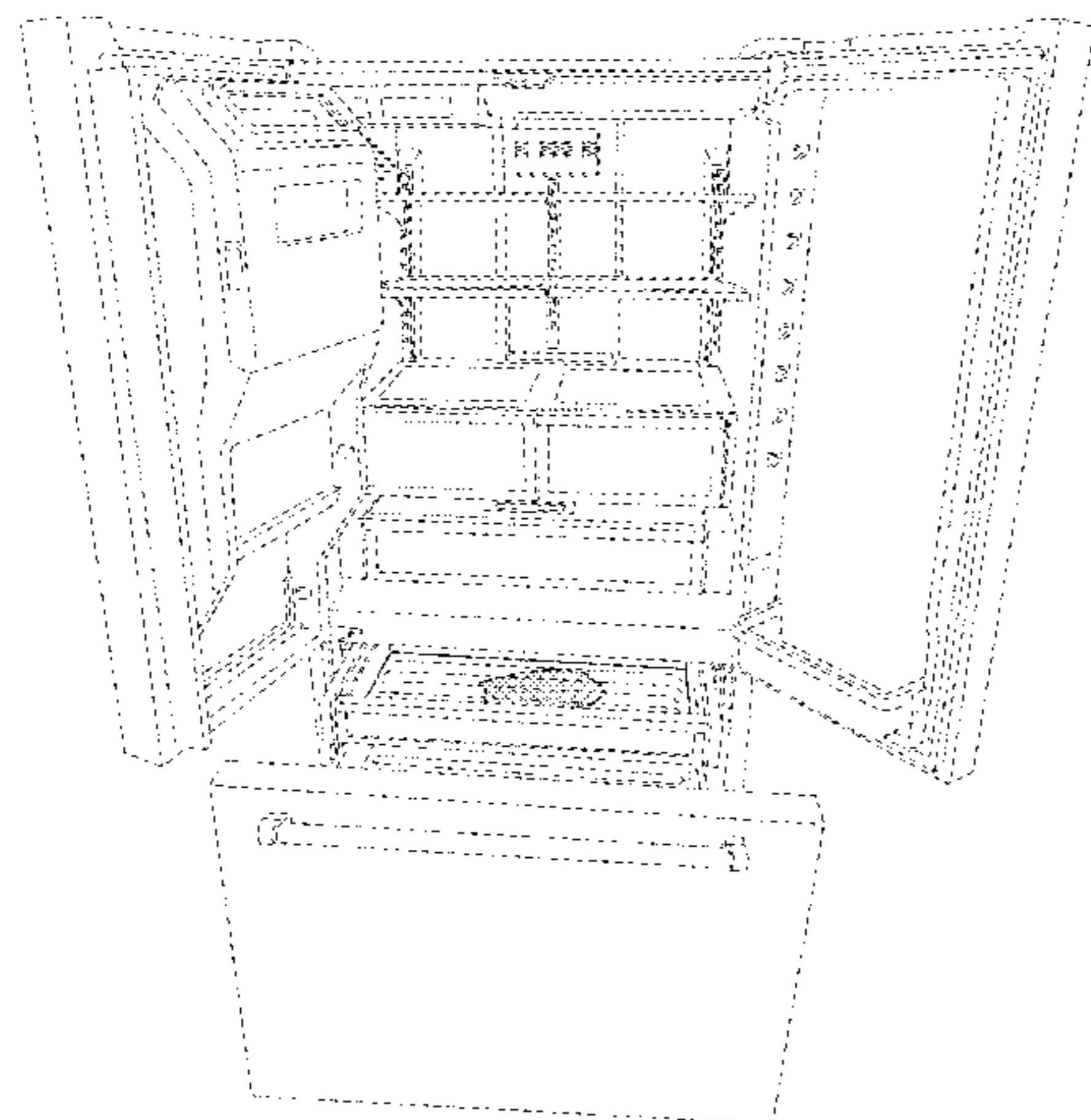

(56)

References Cited

U.S. PATENT DOCUMENTS

D647,927 S *	11/2011	Lee et al.	D15/85	D671,572 S	11/2012	Seo et al.	
D654,515 S *	2/2012	Hwang et al.	D15/85	D674,417 S	1/2013	Seo et al.	
D655,321 S *	3/2012	Lee et al.	D15/86	D685,010 S	6/2013	Seo et al.	
D658,214 S	4/2012	Seo et al.		D707,735 S *	6/2014	Cho et al.	D15/91
D668,696 S	10/2012	Seo et al.		D710,401 S *	8/2014	Ringemann et al.	D15/85
D671,151 S	11/2012	Seo et al.		D710,402 S *	8/2014	Jeon et al.	D15/86
				D716,851 S *	11/2014	Seo et al.	D15/89
				D718,346 S *	11/2014	Cho et al.	D15/81
				D718,349 S *	11/2014	Cho et al.	D15/85

* cited by examiner

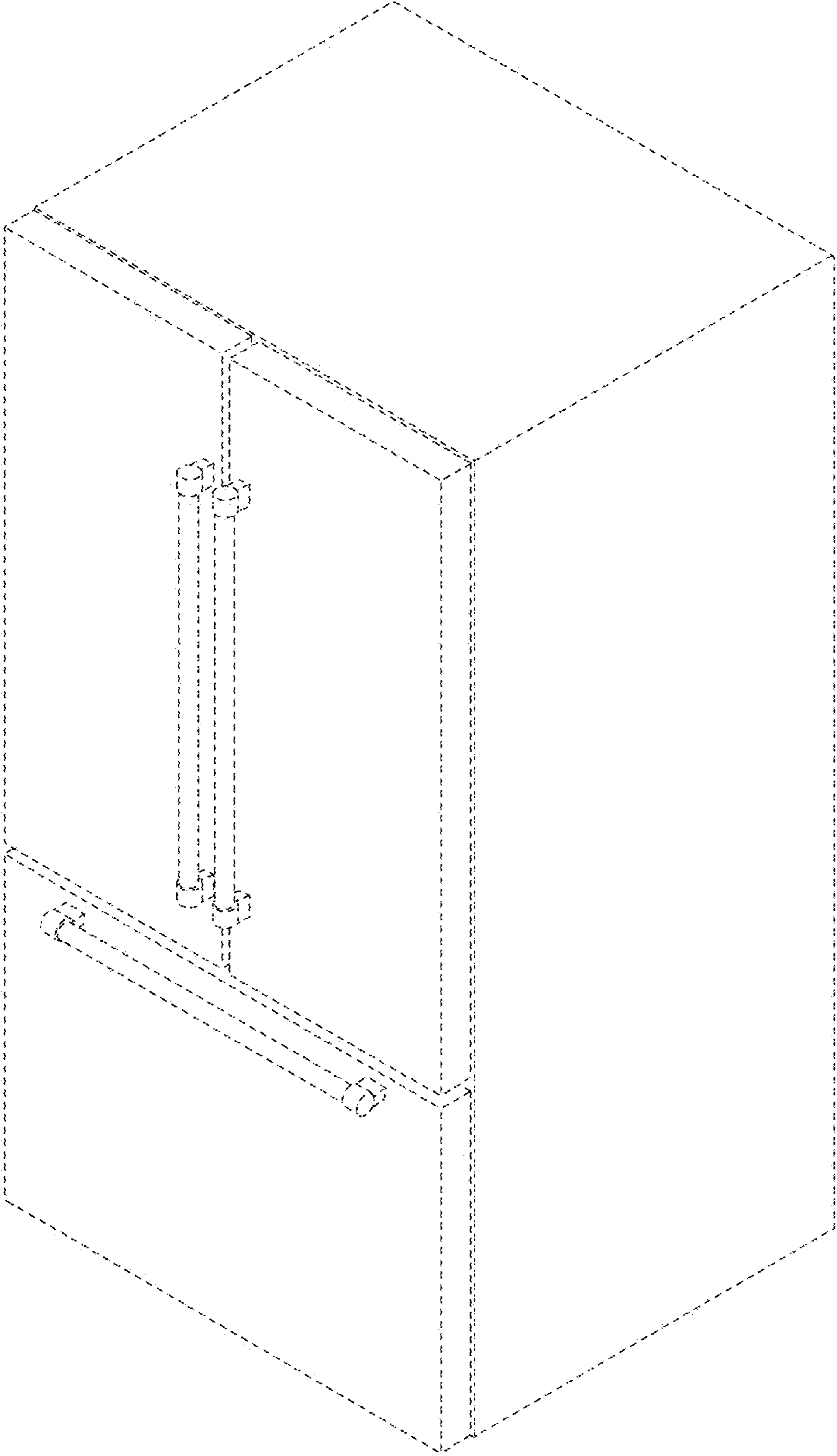

FIG. 1

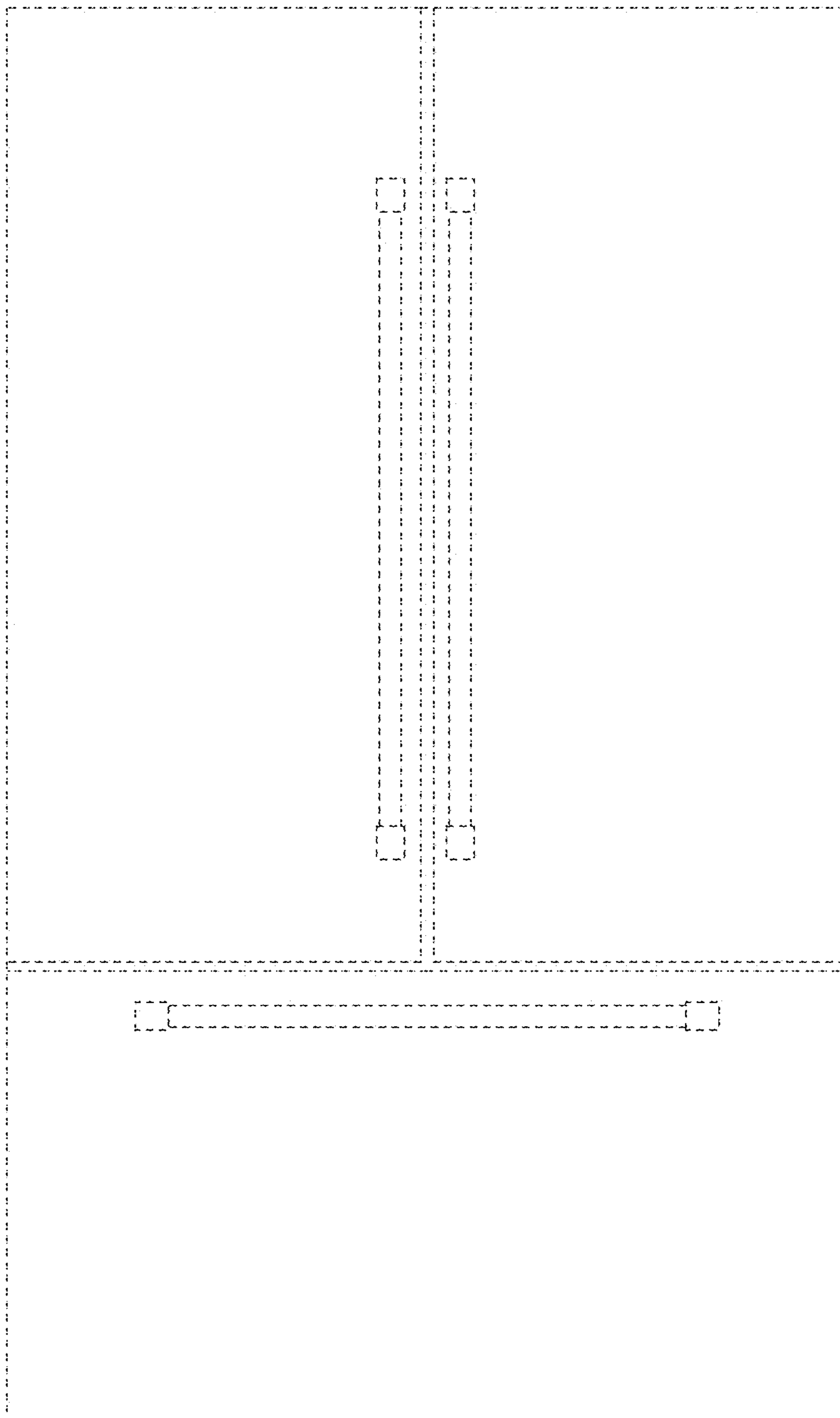

FIG. 2

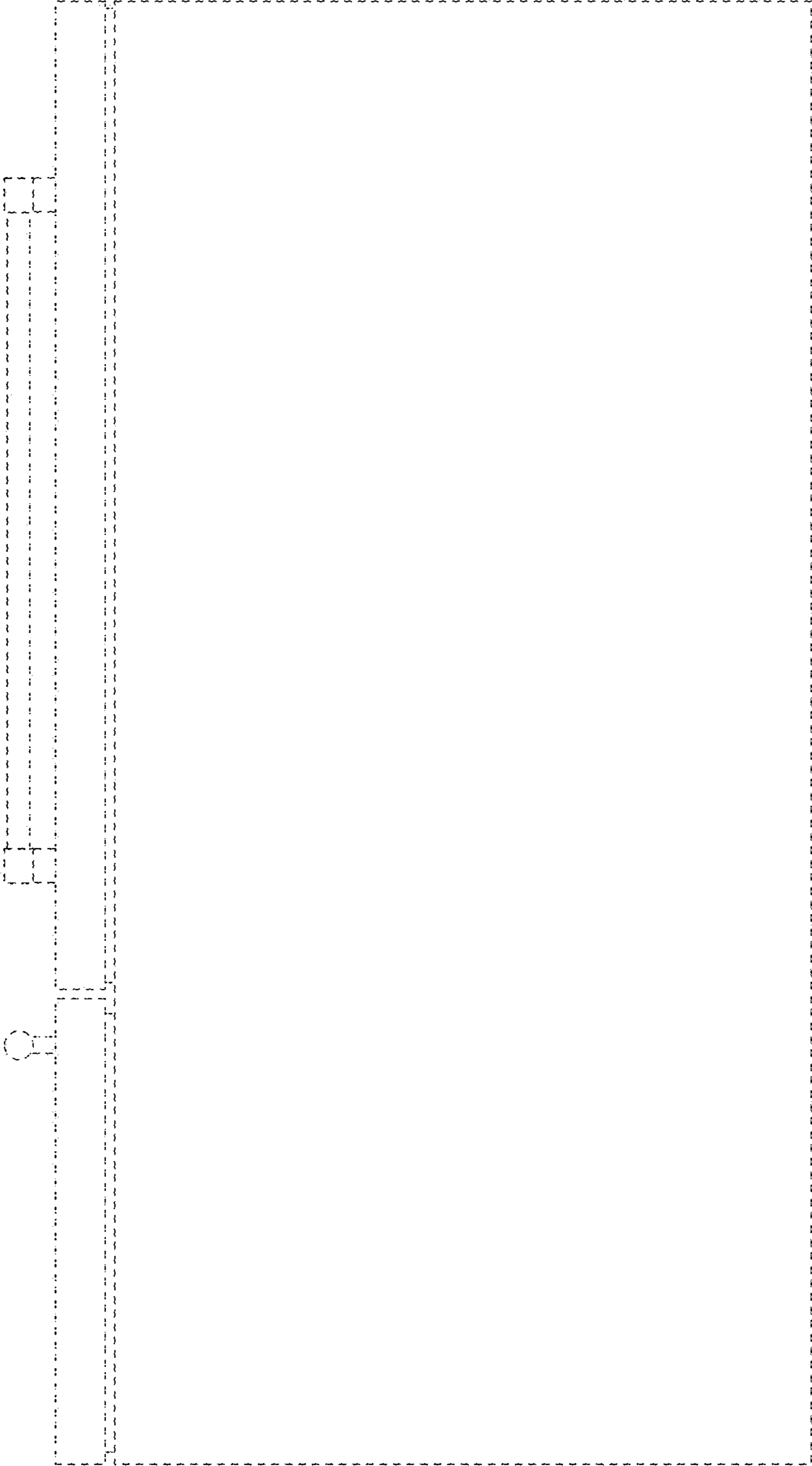

FIG. 3

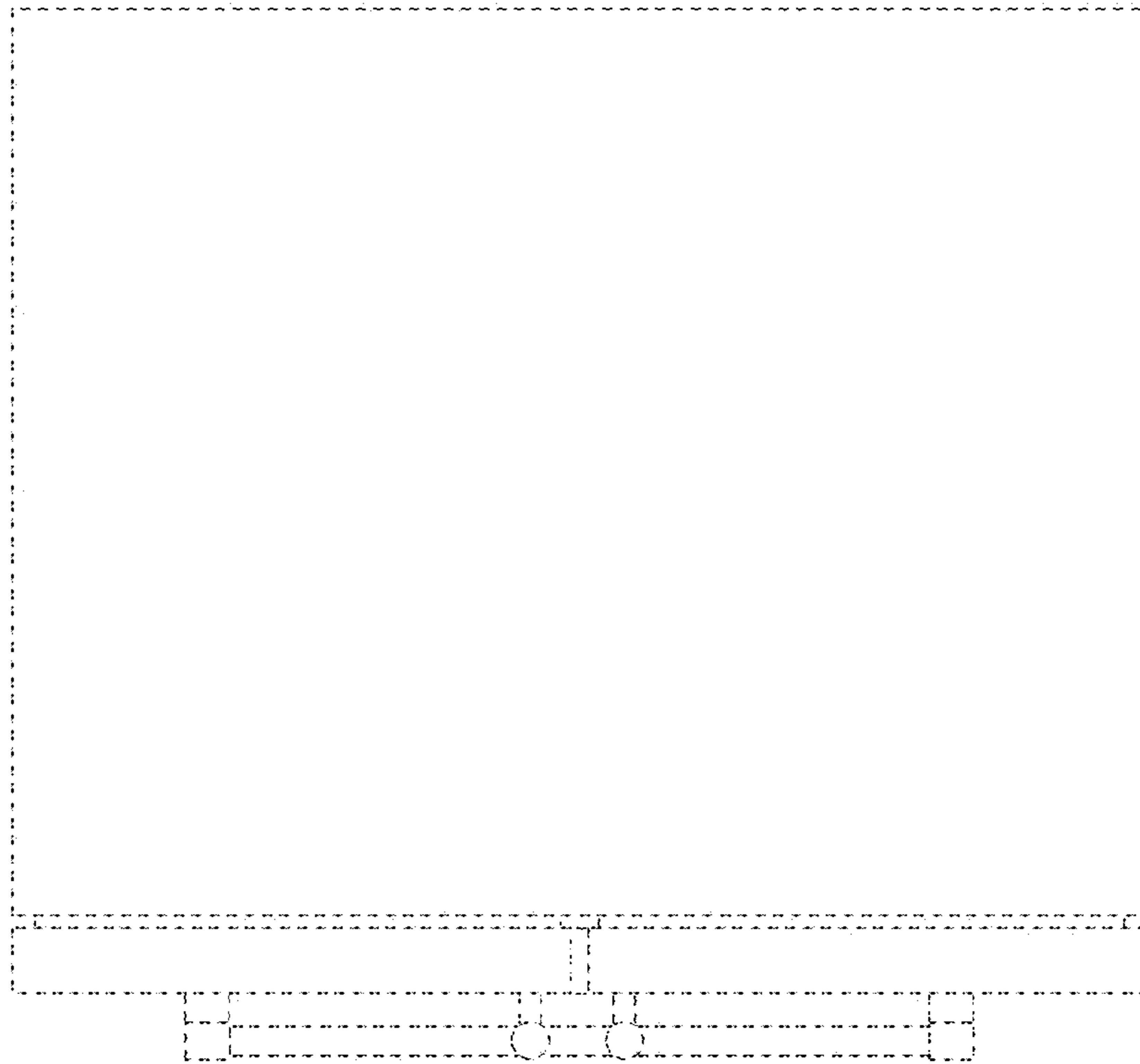

FIG. 4

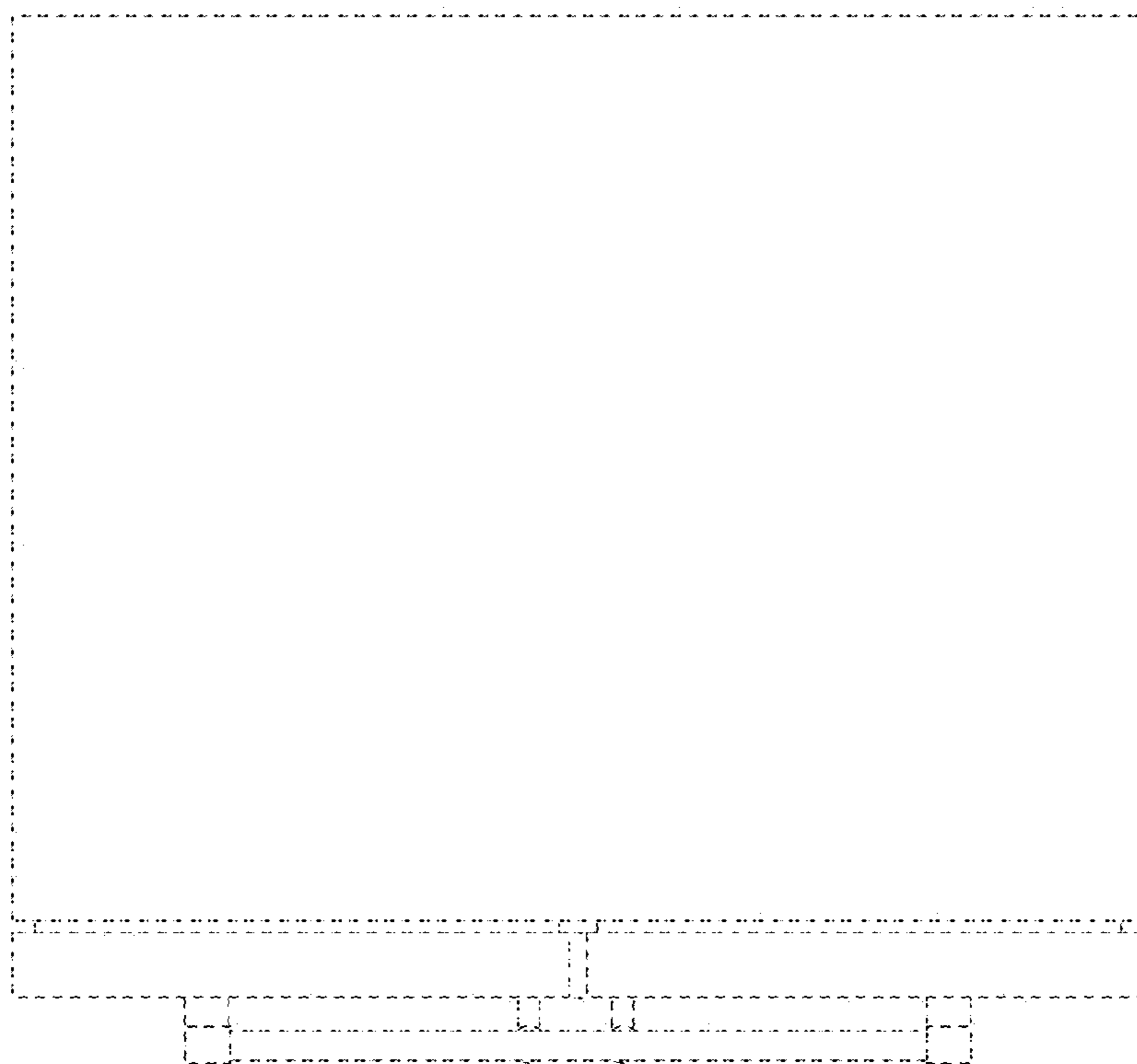

FIG. 5

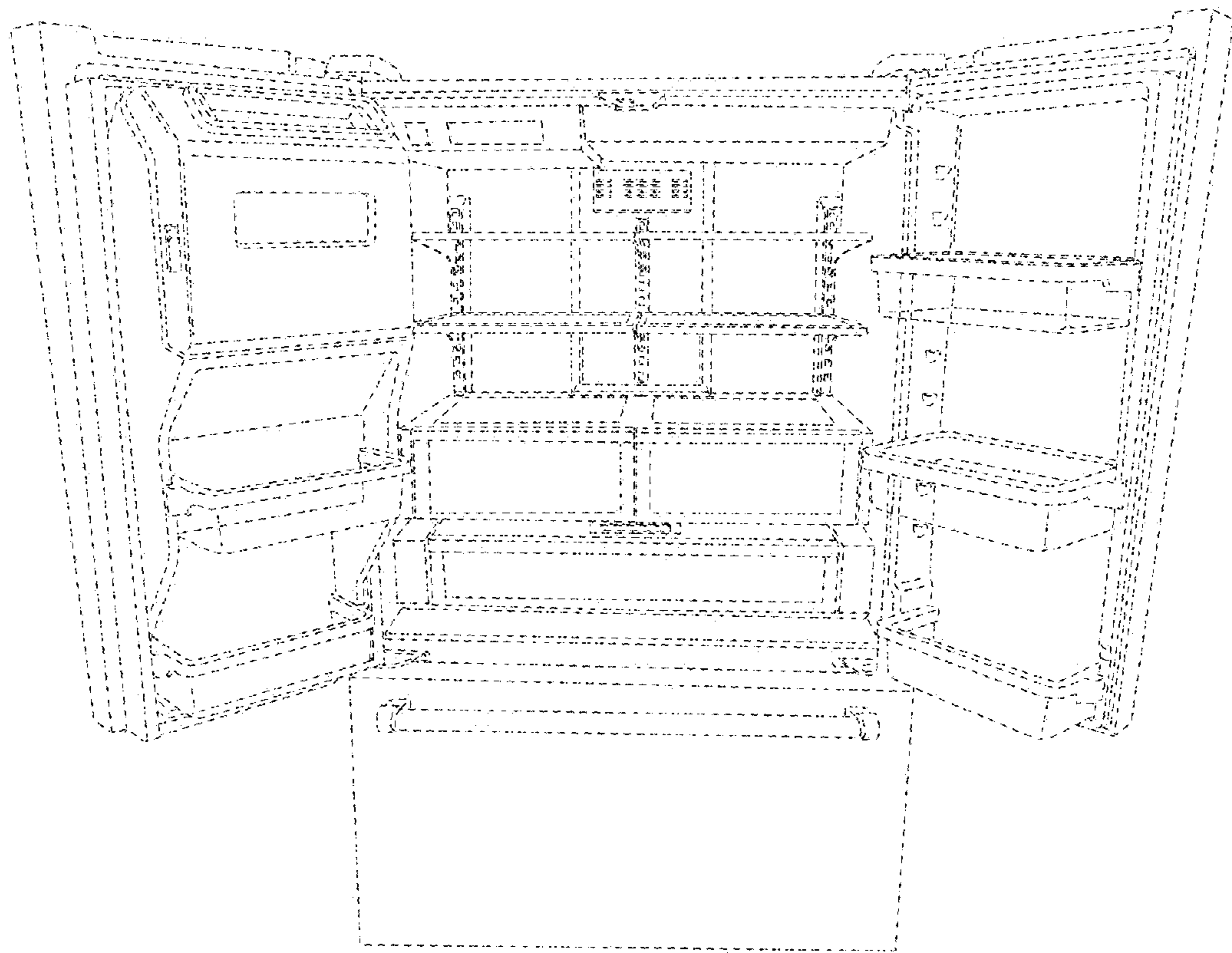

FIG. 6

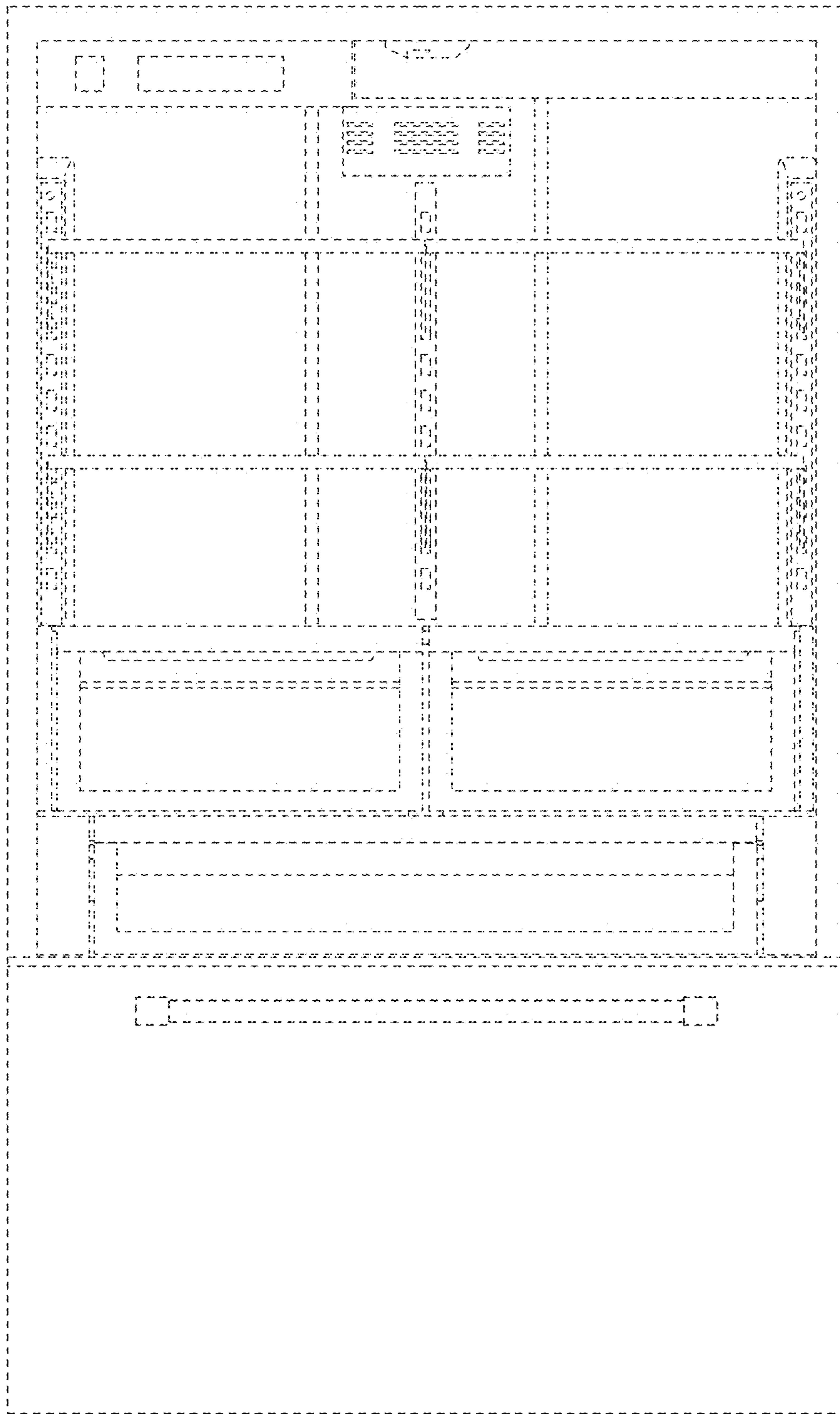

FIG. 7

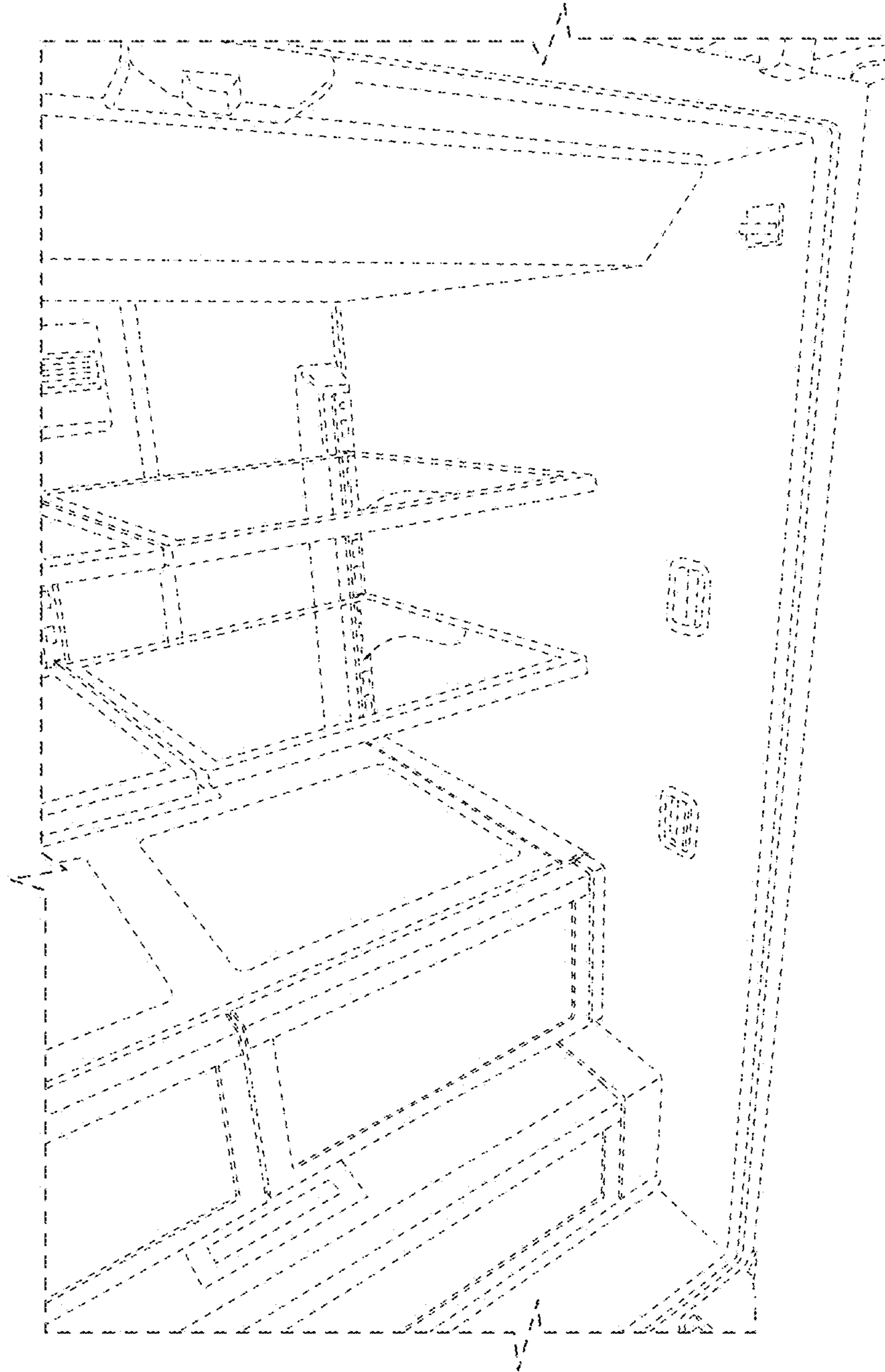

FIG. 8

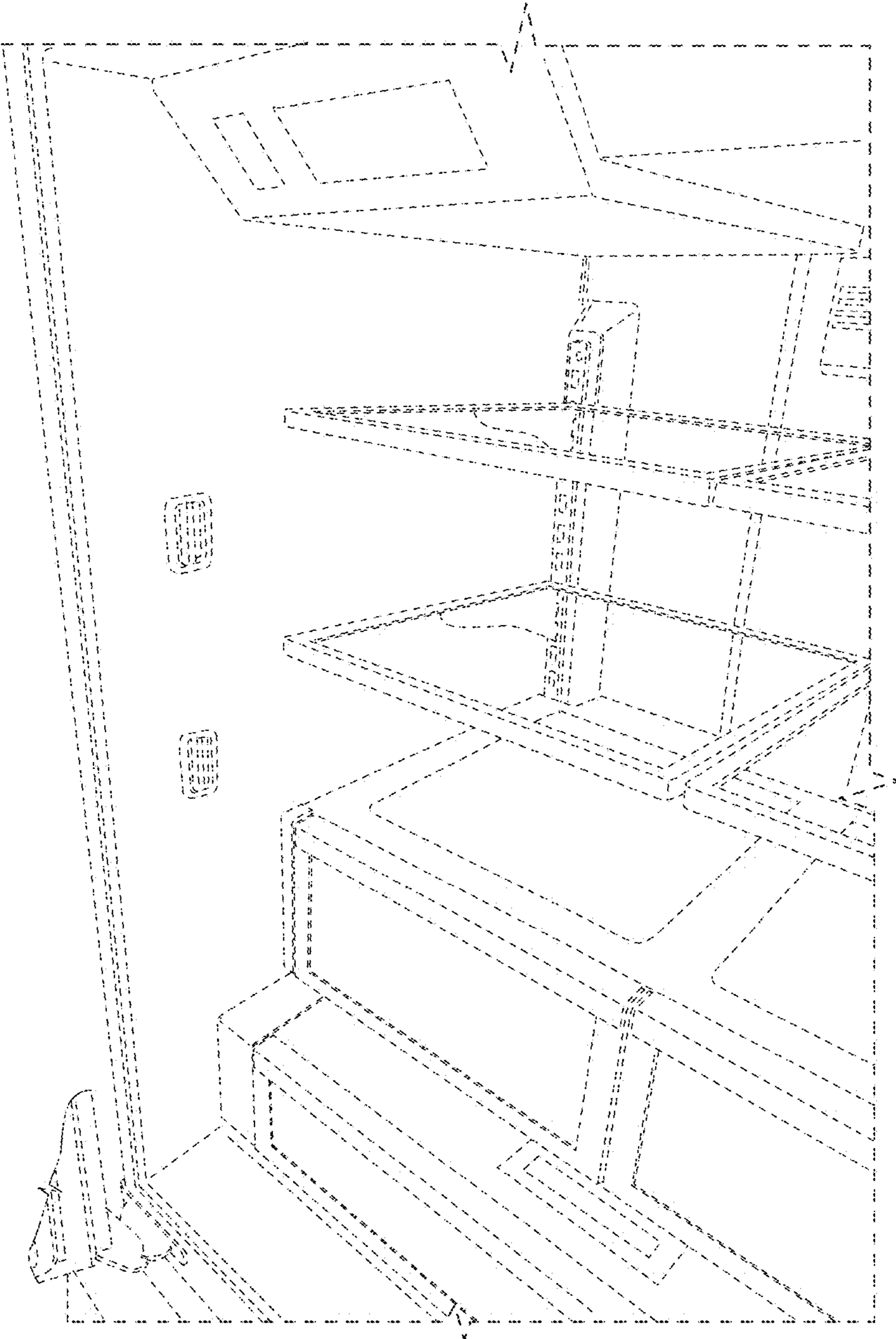

FIG. 9

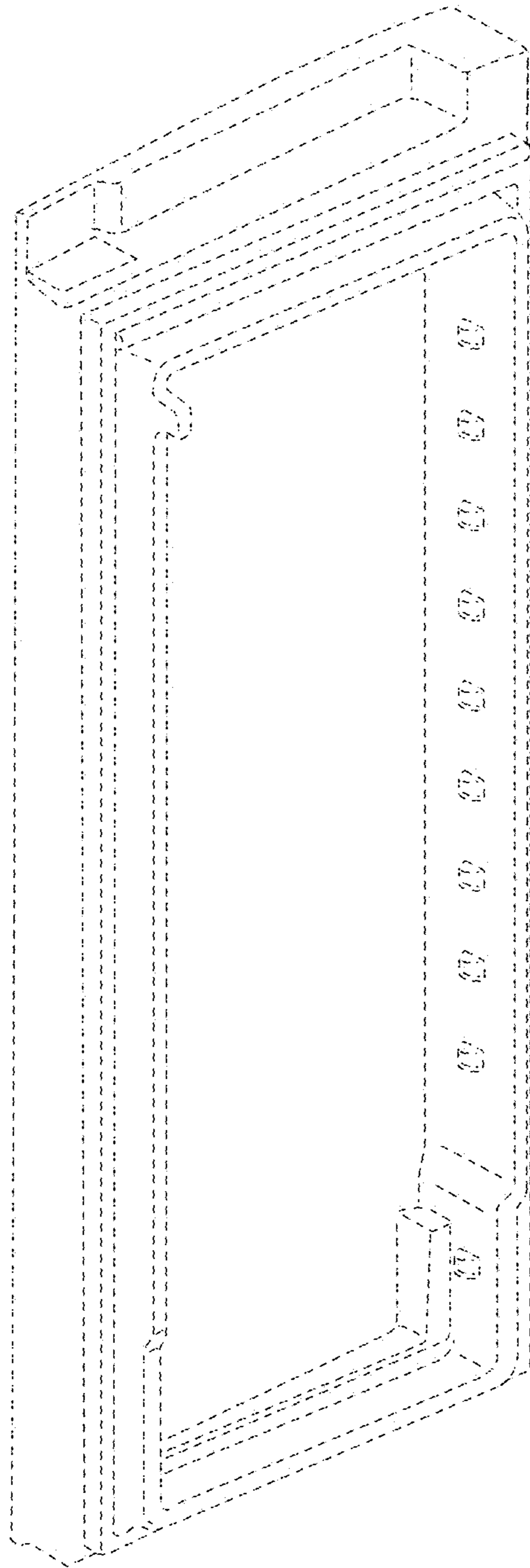

FIG. 10

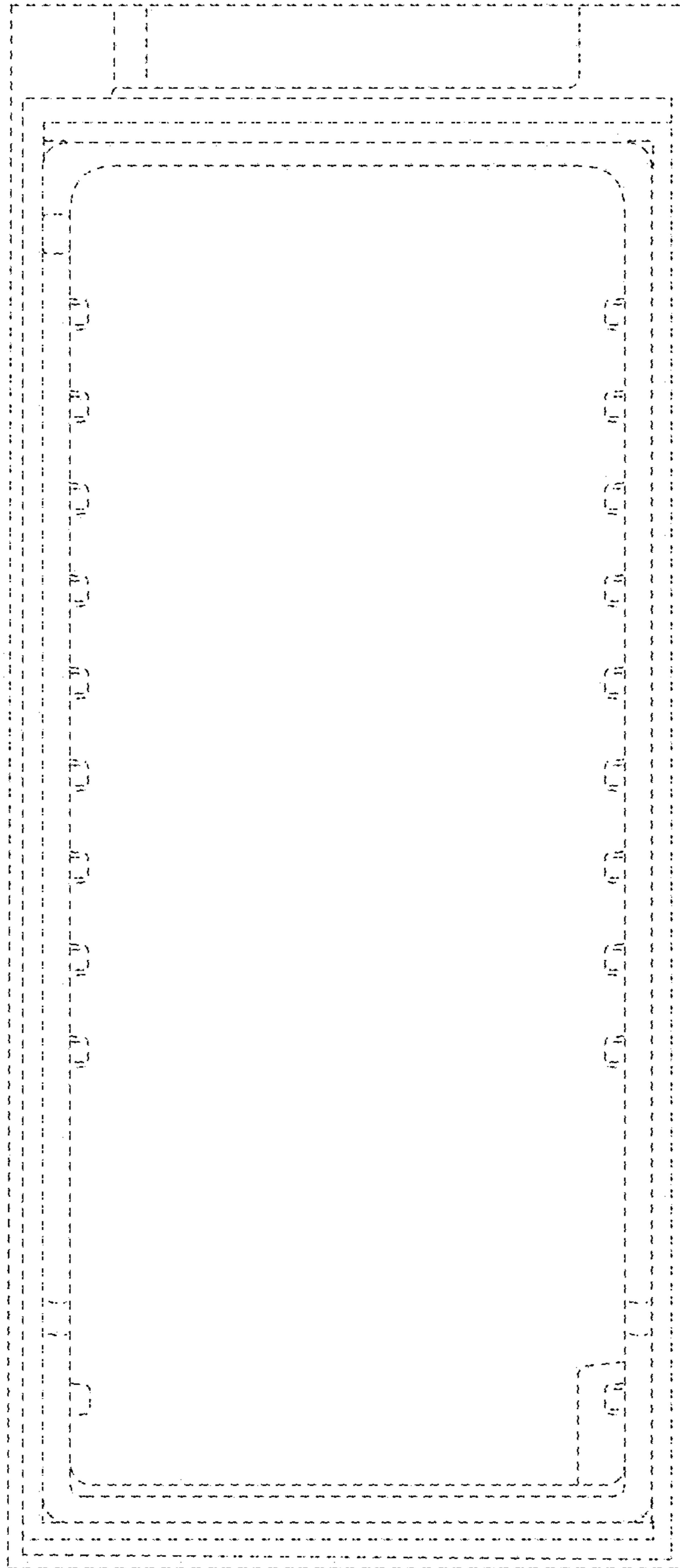

FIG. 11

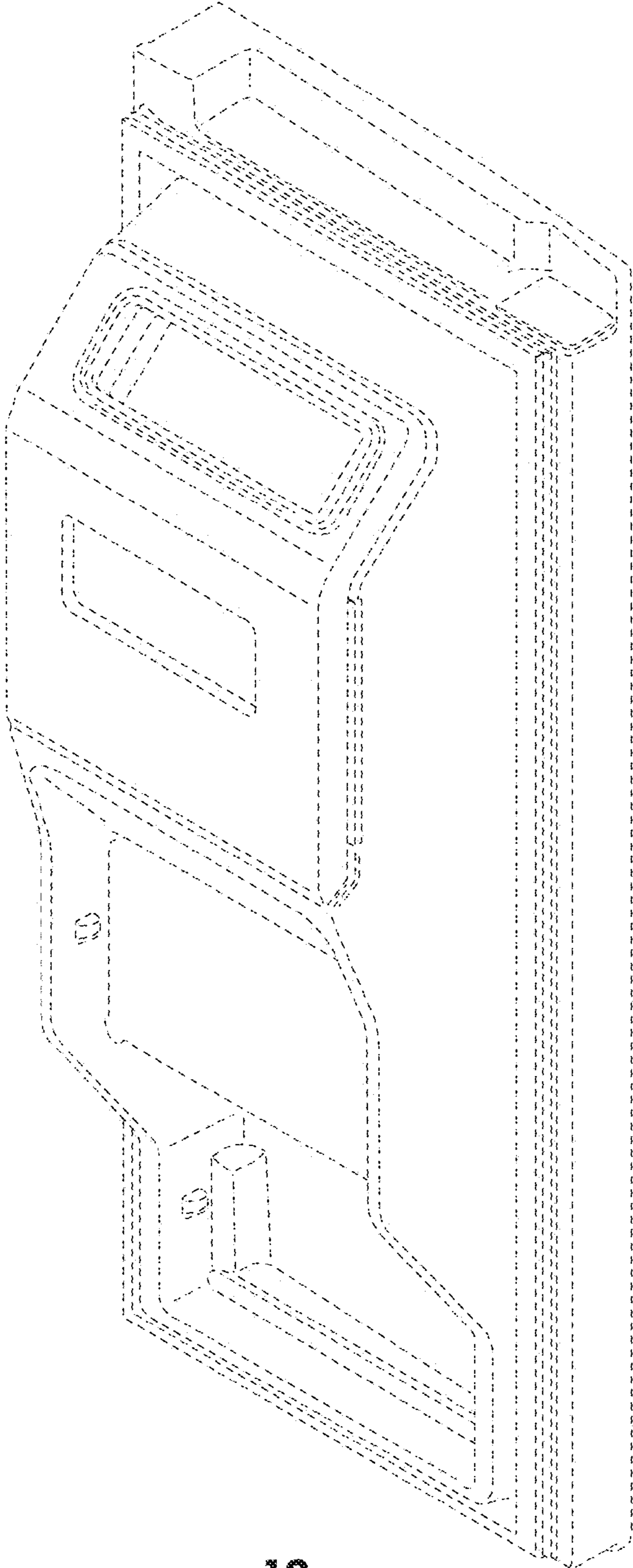

FIG. 12

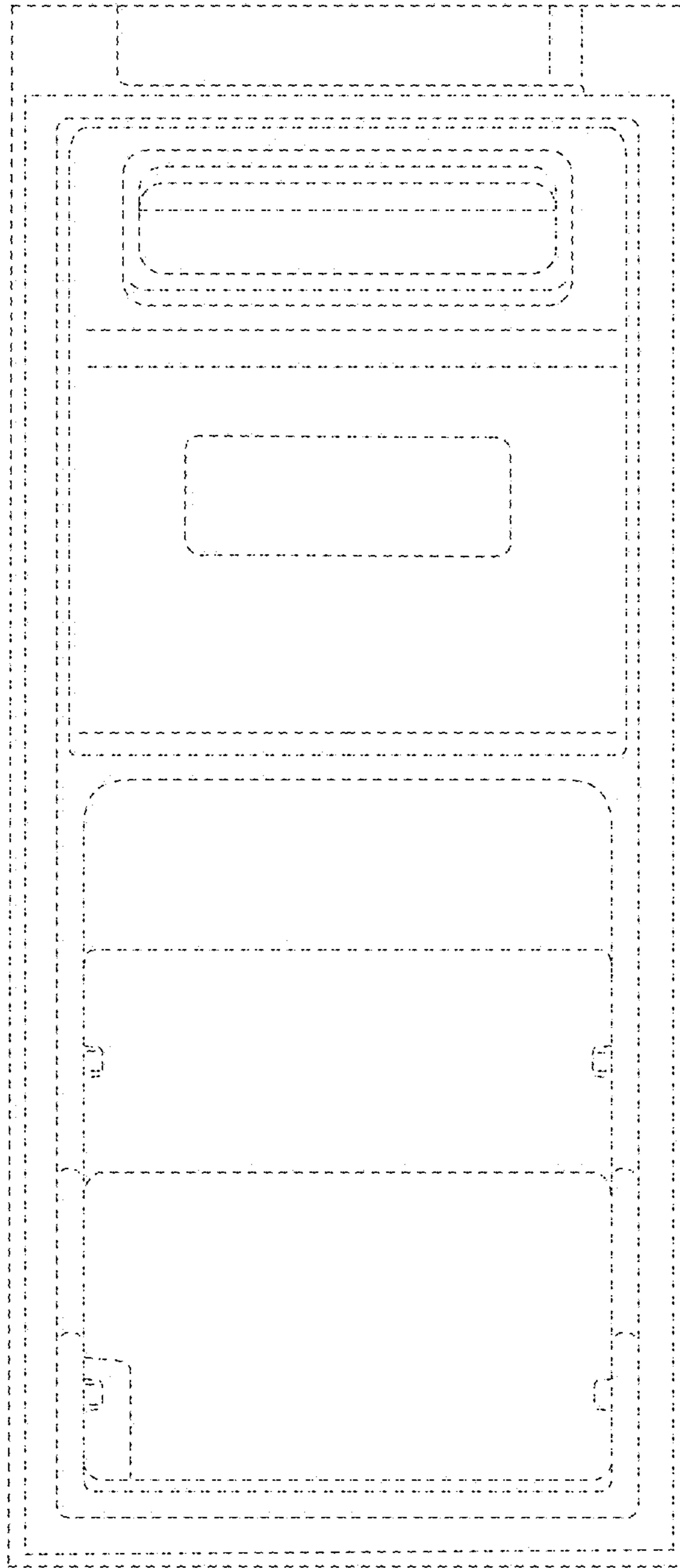

FIG. 13

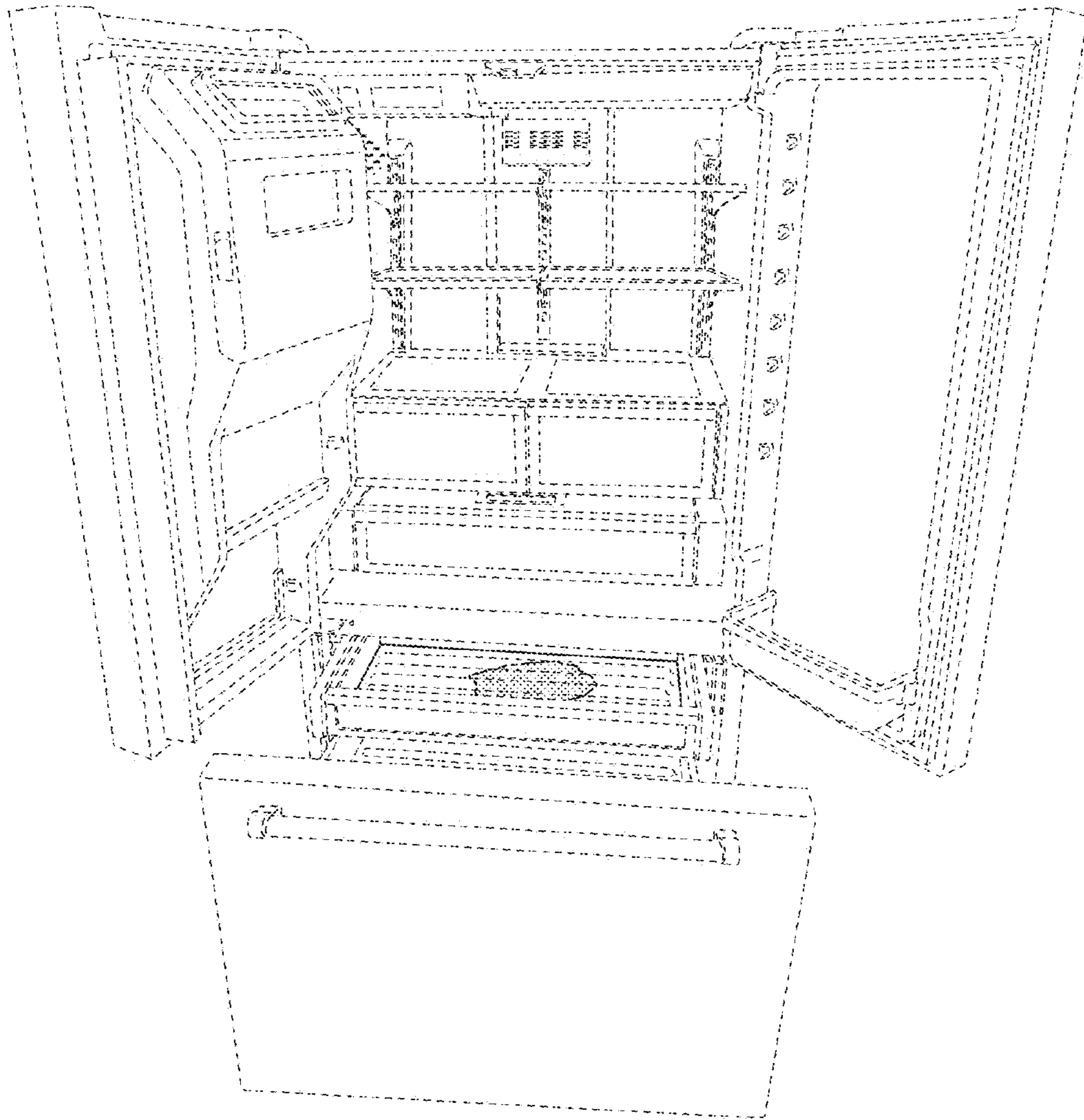

FIG. 14

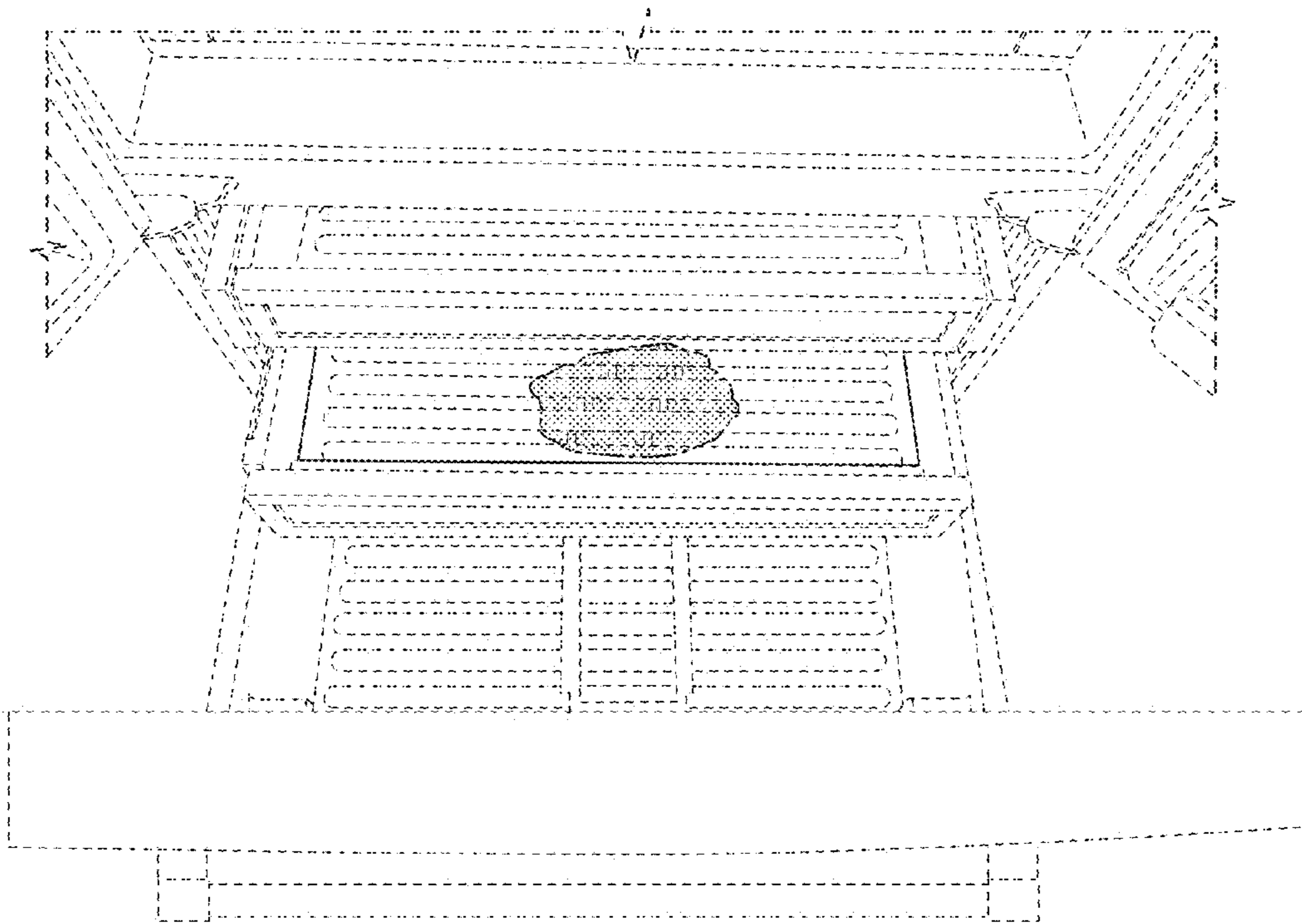

FIG. 15

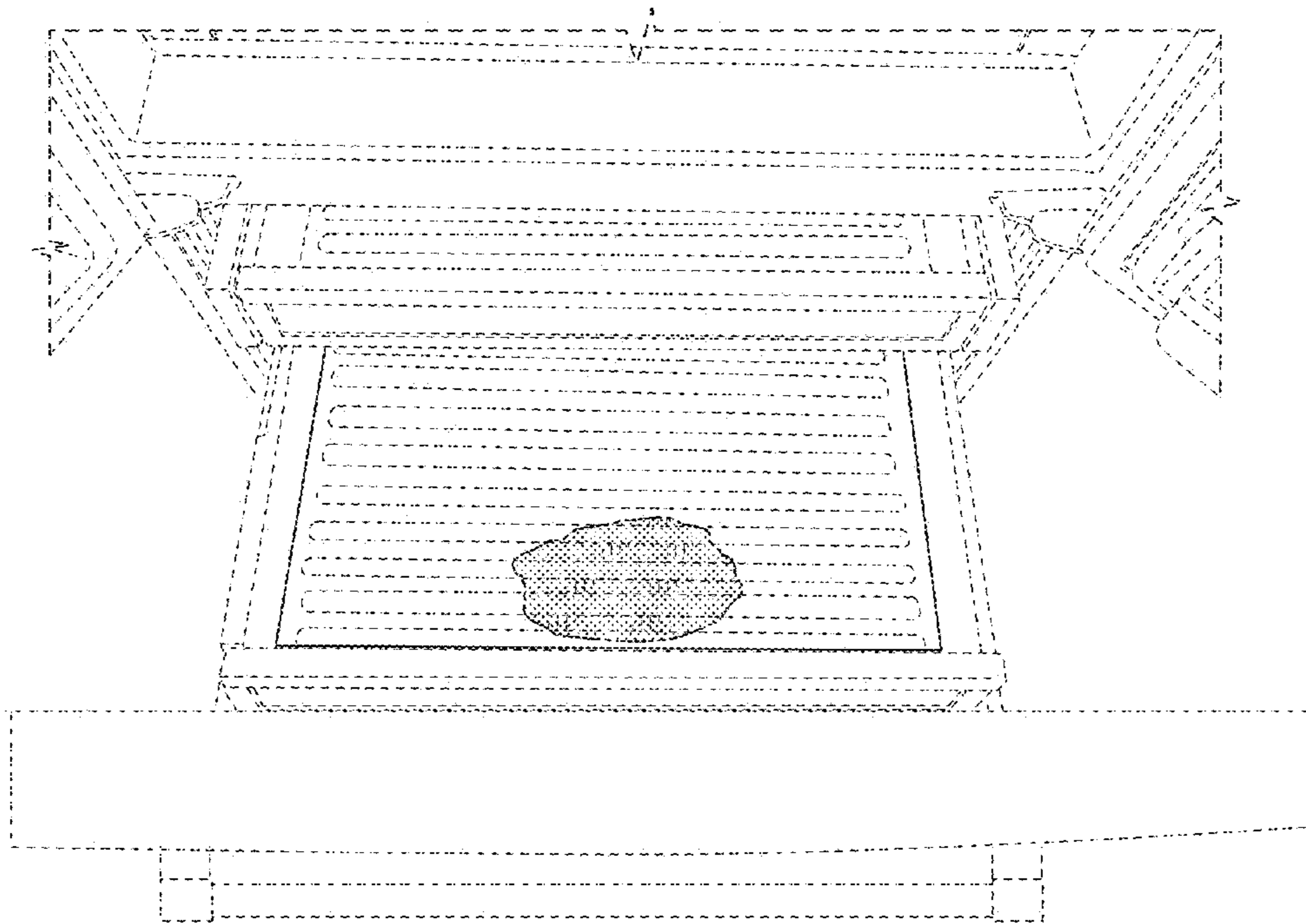

FIG. 16

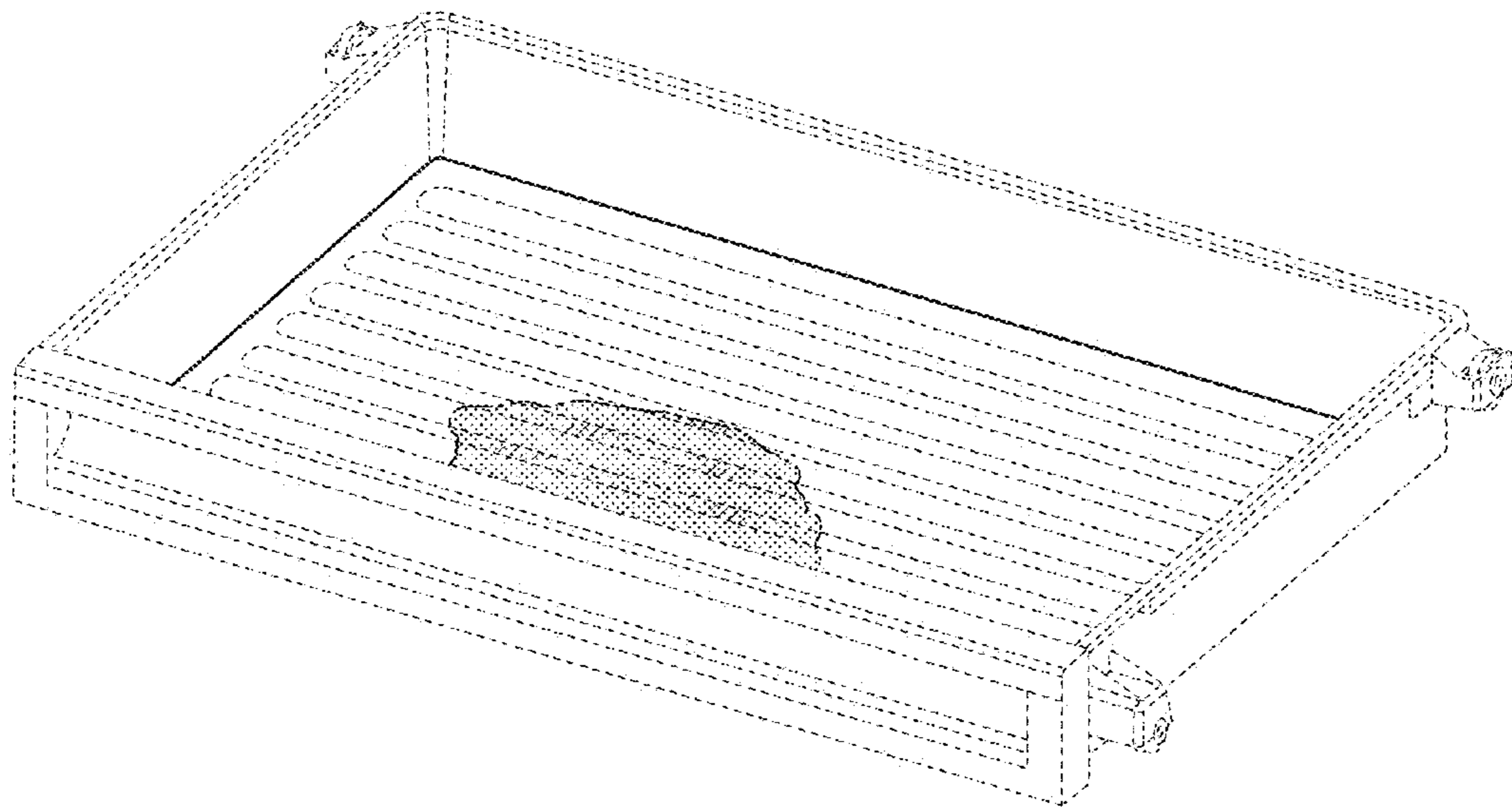

FIG. 17