



US00D749070S

(12) **United States Design Patent**  
**Oh**

(10) **Patent No.:** **US D749,070 S**

(45) **Date of Patent:** **\*\* Feb. 9, 2016**

(54) **TABLET PC**

(71) Applicant: **Samsung Electronics Co., Ltd.**,  
Suwon-si (KR)

(72) Inventor: **Se-Hun Oh**, Seoul (KR)

(73) Assignee: **SAMSUNG ELECTRONICS CO., LTD.** (KR)

(\*\*) Term: **14 Years**

(21) Appl. No.: **29/459,829**

(22) Filed: **Jul. 3, 2013**

(30) **Foreign Application Priority Data**

Jan. 3, 2013 (KR) ..... 30-2013-0000309

(51) **LOC (10) Cl.** ..... **14-02**

(52) **U.S. Cl.**  
USPC ..... **D14/341**

(58) **Field of Classification Search**

USPC ..... D14/315-318, 341-347, 420, 426, 129,  
D14/130, 496, 137, 138 R, 138 AA, 138 C,  
D14/138 G, 147, 203.1, 203.3, 204.4, 203.7,  
D14/218, 248, 388, 389; D10/50, 65, 104.1;  
D21/329, 330; D6/308, 310  
CPC ... G06F 3/0485; G06F 3/0488; G06F 1/1613;  
G06F 1/1624; G06F 1/1626; G06F 1/165;  
H04M 1/0202; H04M 1/0264; H04M 1/0214;  
H04M 1/0279; H04M 1/0281; H04M 1/0283;  
H04M 1/72544

See application file for complete search history.

(56) **References Cited**

**U.S. PATENT DOCUMENTS**

D255,745 S \* 7/1980 Pedersen ..... 40/746  
D535,292 S \* 1/2007 Shi ..... D14/315

(Continued)

*Primary Examiner* — Barbara Fox

*Assistant Examiner* — Dana K Weiland

(74) *Attorney, Agent, or Firm* — Cantor Colburn LLP

(57) **CLAIM**

I claim, the ornamental design for a tablet PC, as shown and described.

**DESCRIPTION**

FIG. 1 is a front perspective view of a tablet PC showing our new design;

FIG. 2 is a front view of thereof;

FIG. 3 is a rear view of thereof;

FIG. 4 is a left side view of thereof;

FIG. 5 is a right side view of thereof;

FIG. 6 is a top plan view of thereof;

FIG. 7 is a bottom plan view of thereof;

FIG. 8 is an additional front perspective view thereof, with a portion of a stand of the tablet PC in an open position;

FIG. 9 is an additional front view thereof, with a portion of a stand of the tablet PC in an open position;

FIG. 10 is an additional rear view thereof, with a portion of a stand of the tablet PC in an open position;

FIG. 11 is an additional left side view thereof, with a portion of a stand of the tablet PC in an open position;

FIG. 12 is an additional right side view thereof, with a portion of a stand of the tablet PC in an open position;

FIG. 13 is an additional top plan view thereof, with a portion of a stand of the tablet PC in an open position;

FIG. 14 is an additional bottom plan view thereof, with a portion of a stand of the tablet PC in an open position; and,

FIG. 15 is a rear perspective view thereof, with a portion of a stand of the tablet PC in an open position.

The broken lines shown in the drawings represent portions of the tablet PC that form no part of the claimed design.

The shade lines in the Figures show transparency and not surface ornamentation.

**1 Claim, 15 Drawing Sheets**

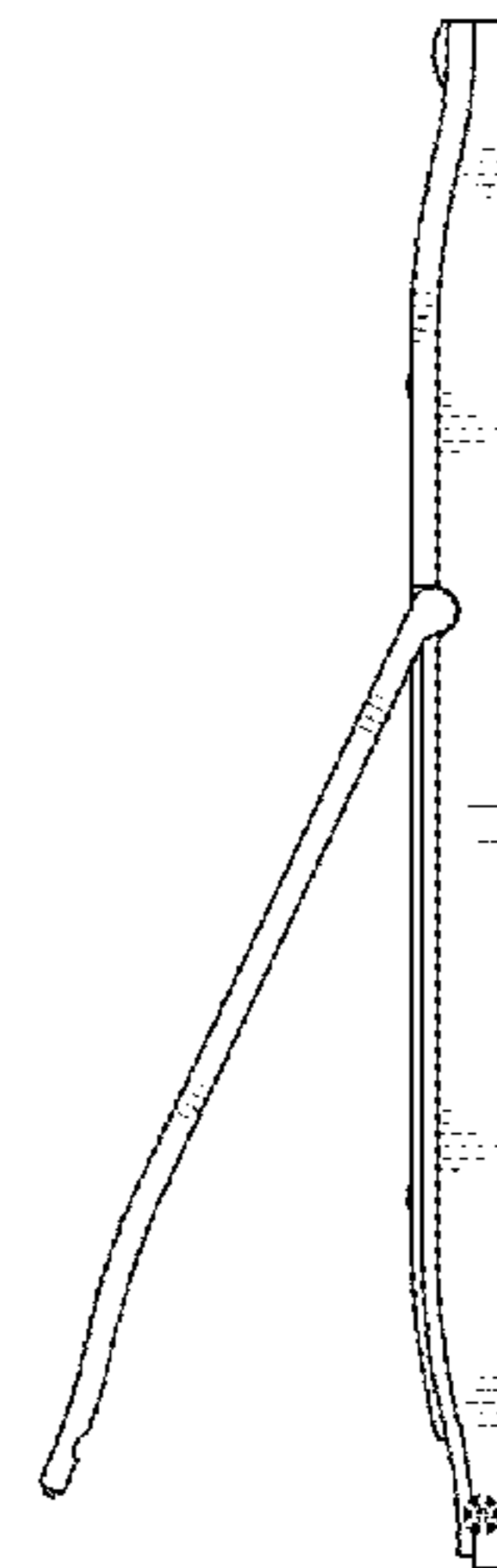
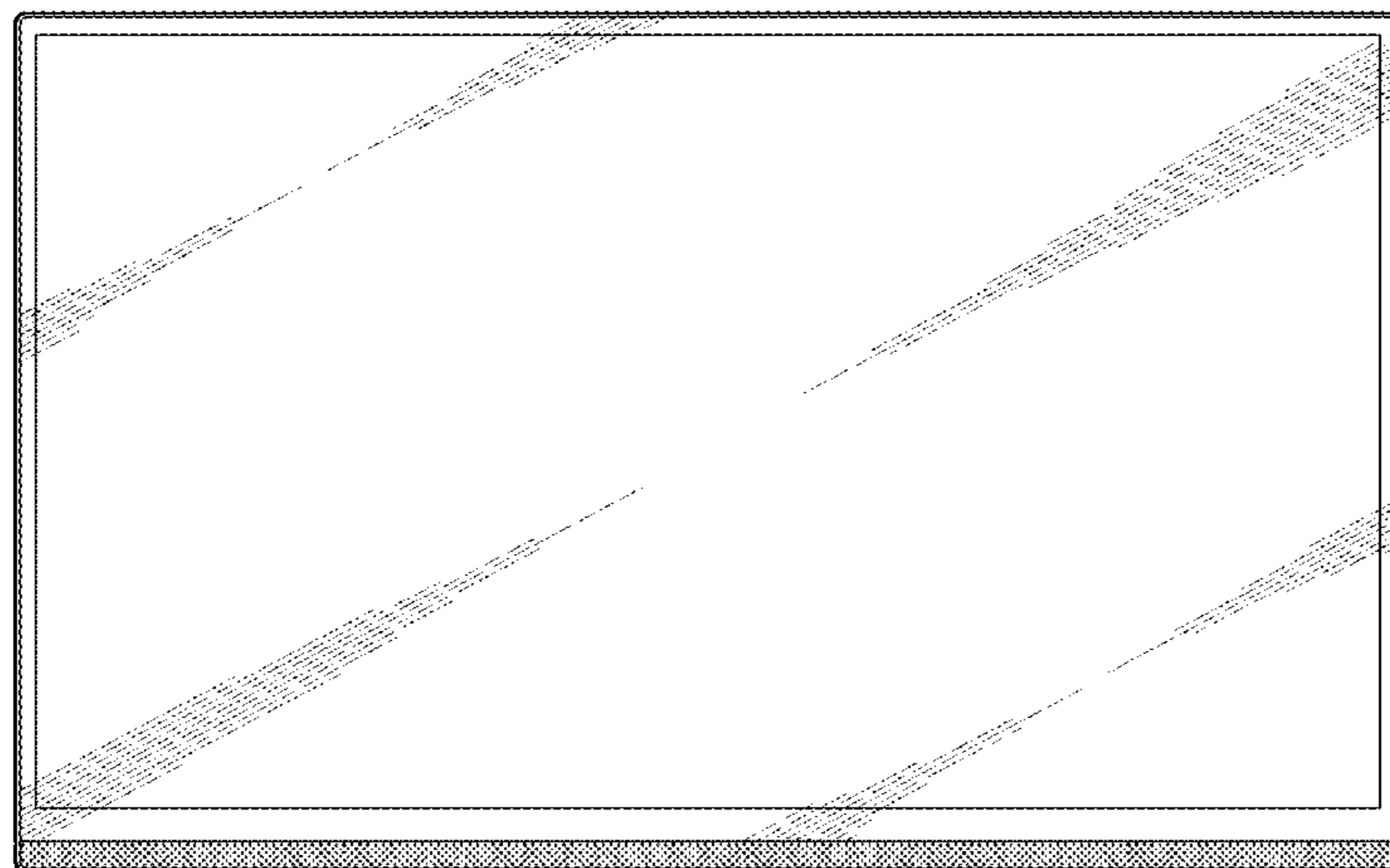

(56)

References Cited

U.S. PATENT DOCUMENTS

D572,743 S *	7/2008	Madonna	.....	D14/126	D696,246 S *	12/2013	Kim	.....	D14/341
D585,399 S *	1/2009	Hwang	.....	D14/130	D701,847 S *	4/2014	Choi	.....	D14/138 AD
D592,625 S *	5/2009	Hwang	.....	D14/130	D702,232 S *	4/2014	Choi	.....	D14/341
D607,854 S *	1/2010	Sagawa	.....	D14/126	D705,219 S *	5/2014	Martin	.....	D14/315
D615,527 S *	5/2010	Hwang	.....	D14/203.7	D705,776 S *	5/2014	Groene	.....	D14/341
D620,007 S *	7/2010	Jeon	.....	D14/371	D706,252 S *	6/2014	Kim	.....	D14/248
D624,535 S *	9/2010	Tsai	.....	D14/336	D706,773 S *	6/2014	Lu	.....	D14/341
D624,893 S *	10/2010	Kasuga	.....	D14/126	D711,371 S *	8/2014	Chen	.....	D14/341
D639,267 S *	6/2011	DeLorenzo	.....	D14/130	D715,301 S *	10/2014	Ashcraft	.....	D14/439
D663,281 S *	7/2012	Hwang	.....	D14/138 G	D716,799 S *	11/2014	Green	.....	D14/341
D667,399 S *	9/2012	Koh	.....	D14/341	D719,158 S *	12/2014	Akana	.....	D14/374
D671,514 S *	11/2012	Kim	.....	D14/138 G	D728,559 S *	5/2015	Lim	.....	D14/341
D671,940 S *	12/2012	Kim	.....	D14/130	D729,235 S *	5/2015	Nagao	.....	D14/341
D677,660 S *	3/2013	Groene	.....	D14/341	D730,308 S *	5/2015	Akana	.....	D14/126
D678,877 S *	3/2013	Groene	.....	D14/341	D732,017 S *	6/2015	Yun	.....	D14/341
D681,591 S *	5/2013	Sung	.....	D14/138 G	D733,124 S *	6/2015	Sung	.....	D14/341
D691,104 S *	10/2013	Park	.....	D14/138 G	D733,126 S *	6/2015	Sung	.....	D14/341
					D733,127 S *	6/2015	Sung	.....	D14/341
					D736,764 S *	8/2015	Yagi	.....	D14/341
					D737,270 S *	8/2015	Young	.....	D14/341

\* cited by examiner

FIG. 1

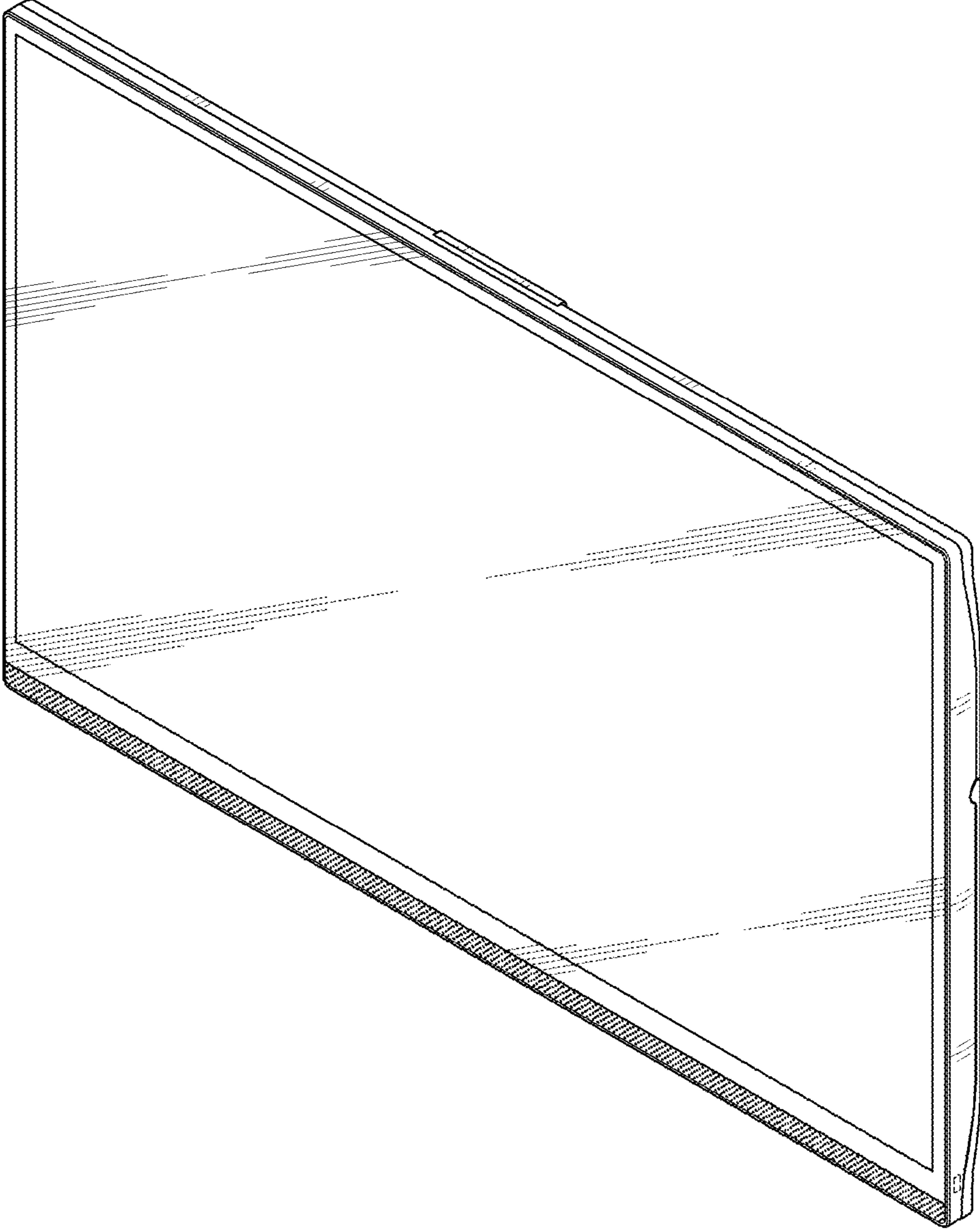

FIG. 2

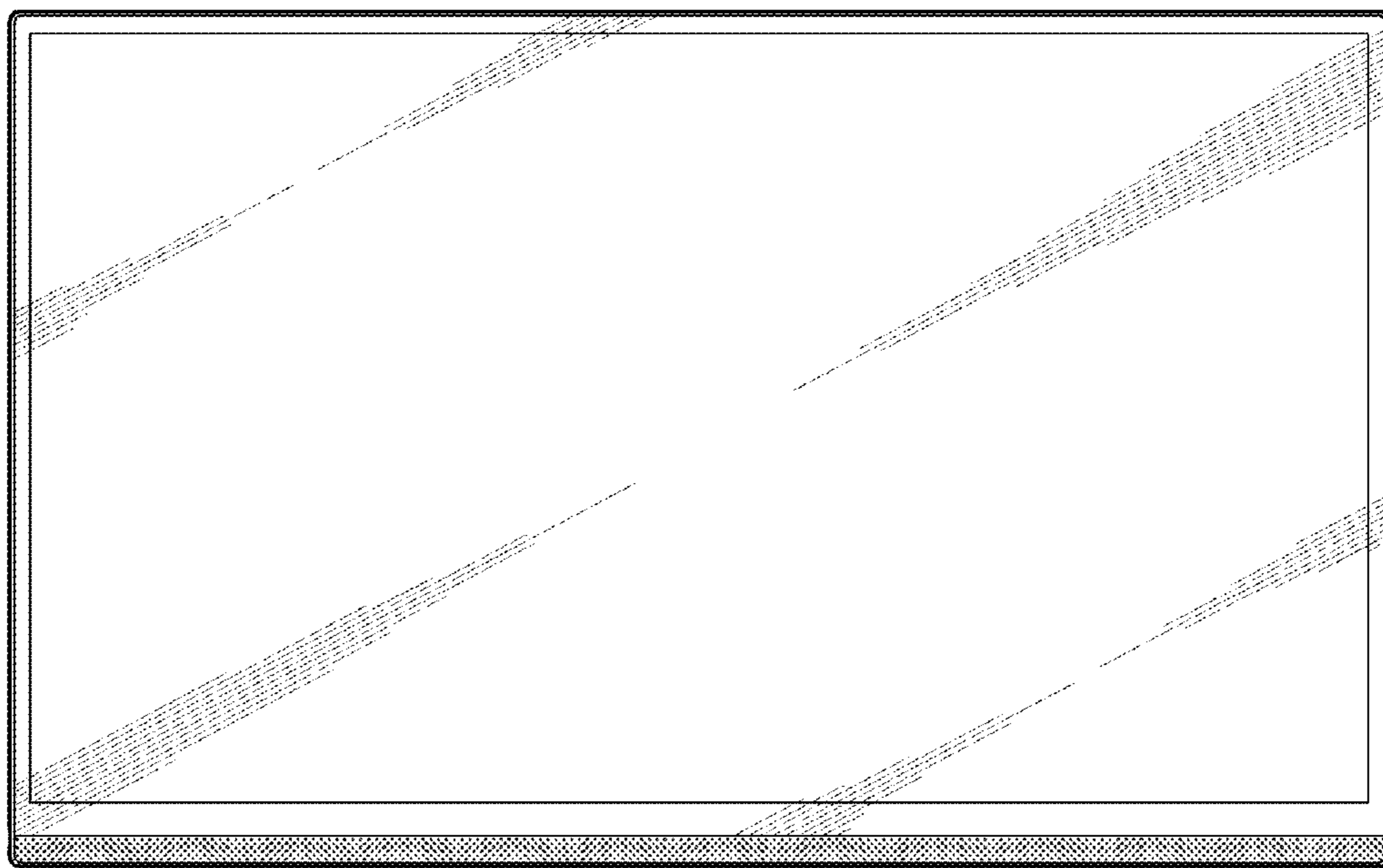

FIG. 3

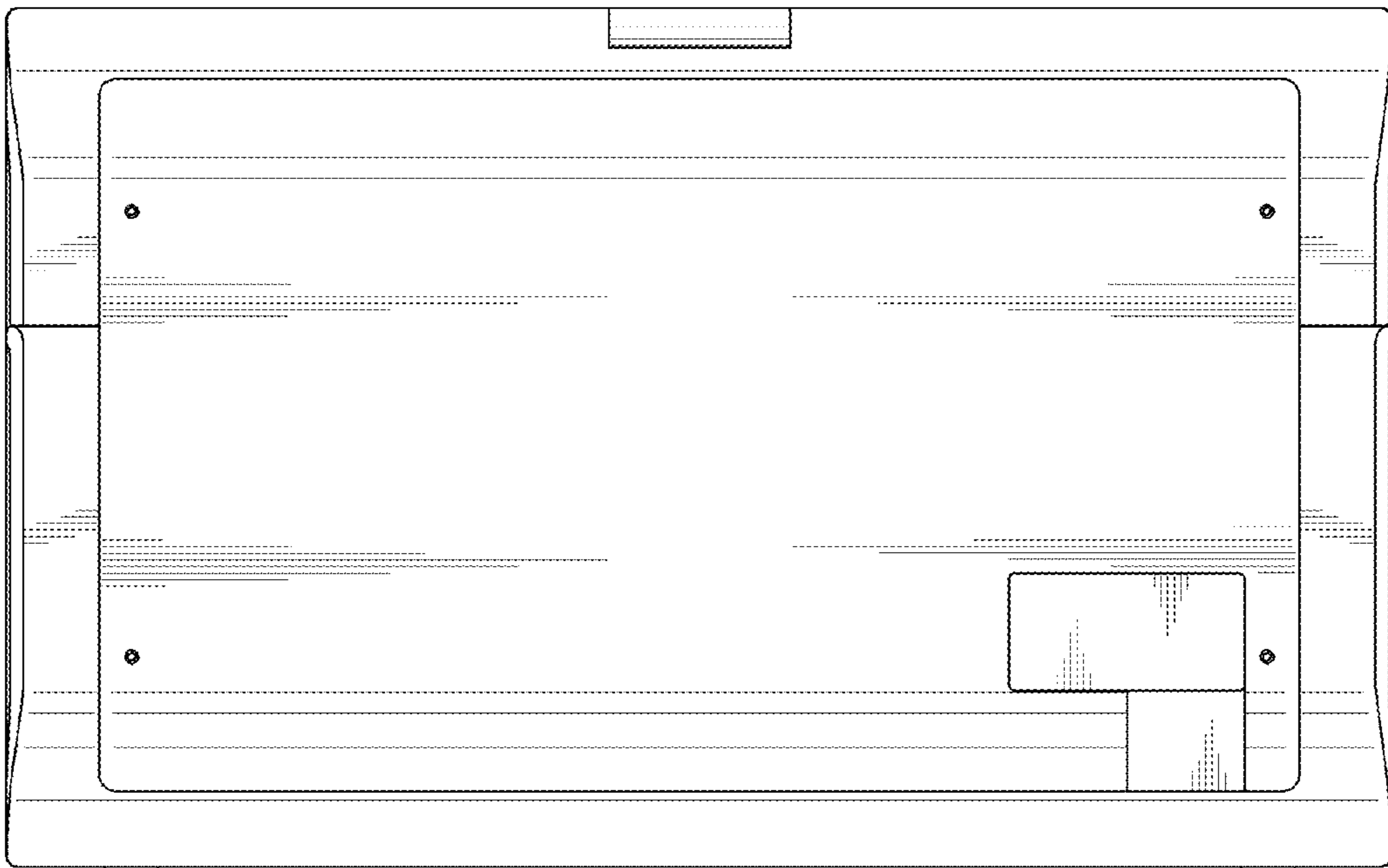

FIG. 4

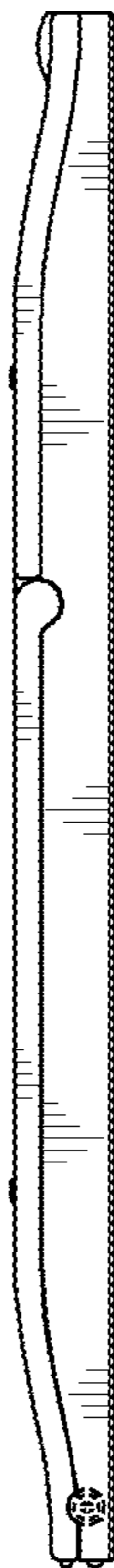

FIG. 5

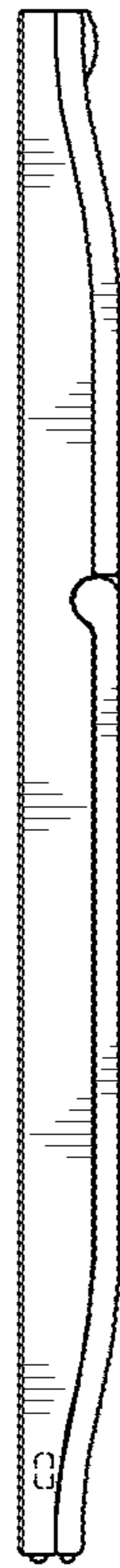

FIG. 6

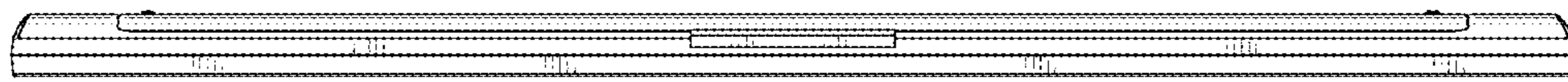



FIG. 7



FIG. 8

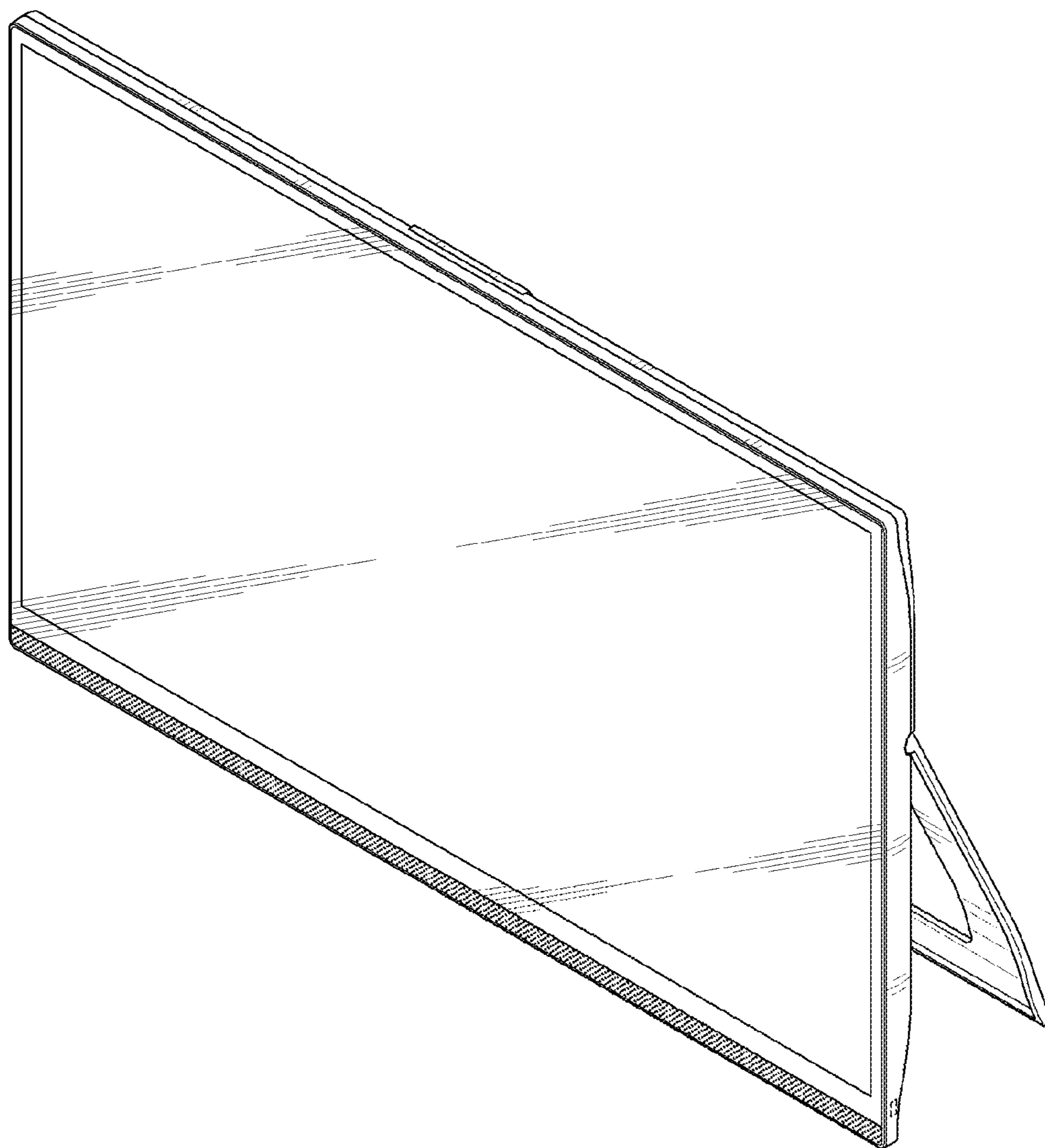

FIG. 9

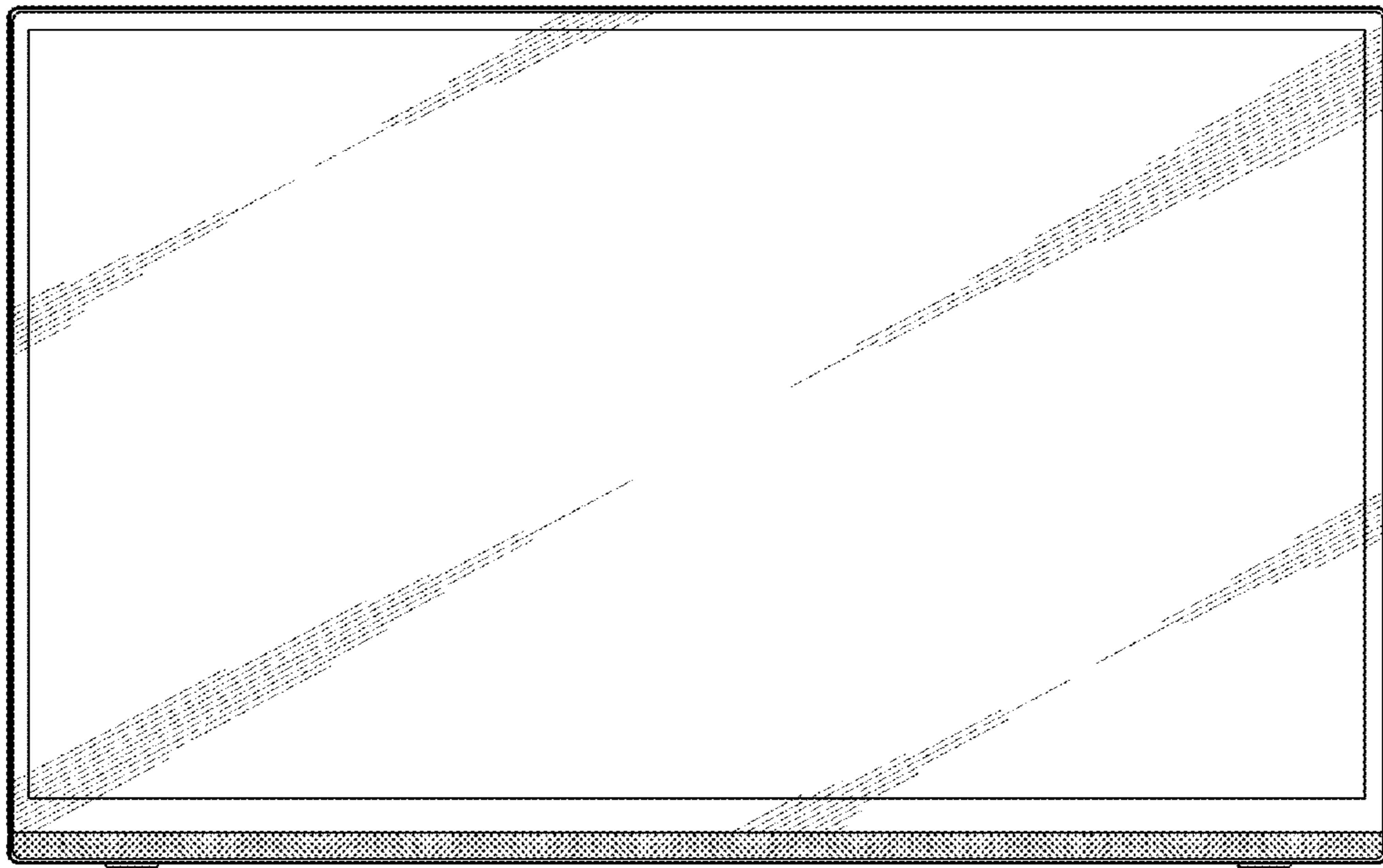

FIG. 10

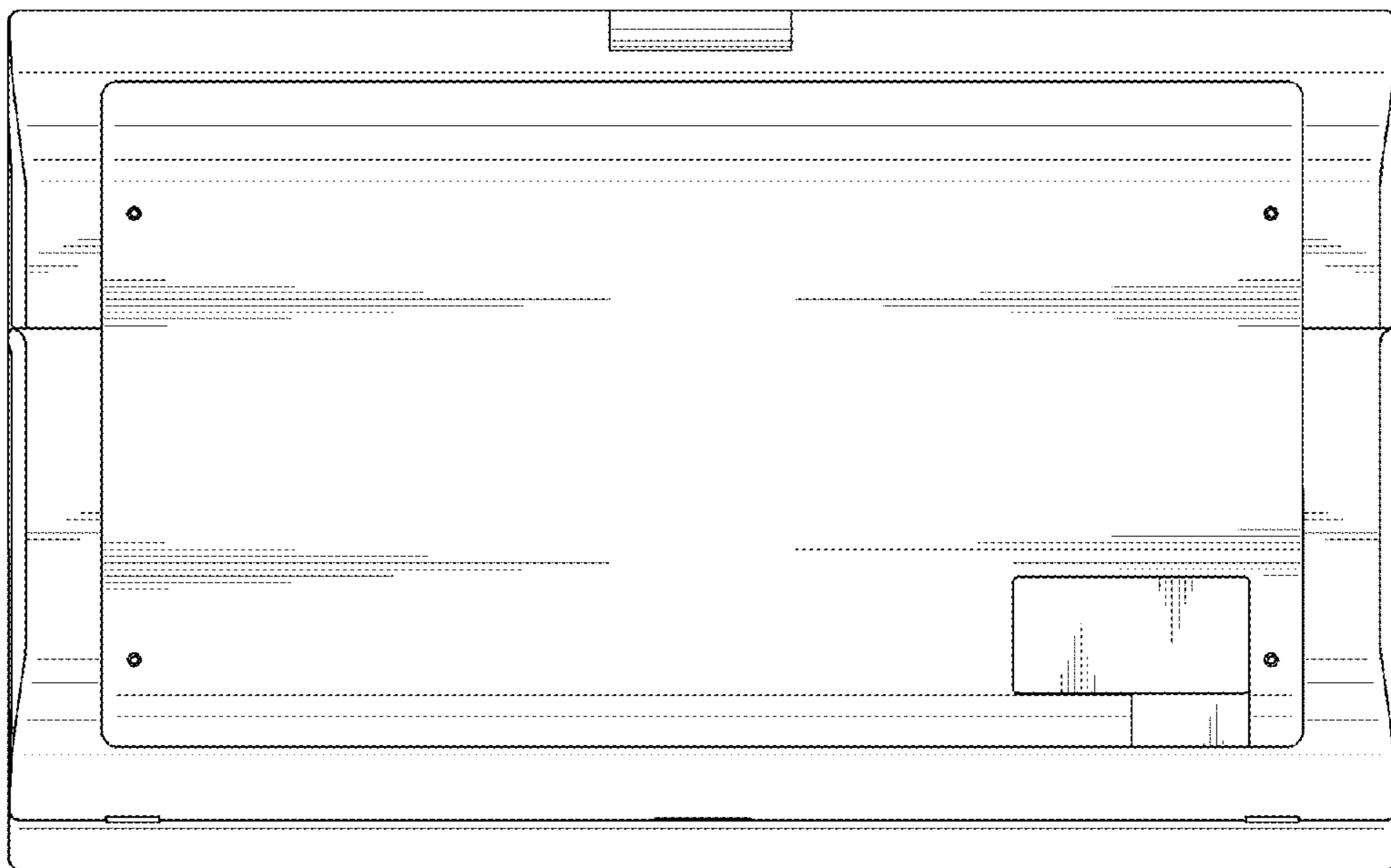

FIG. 11

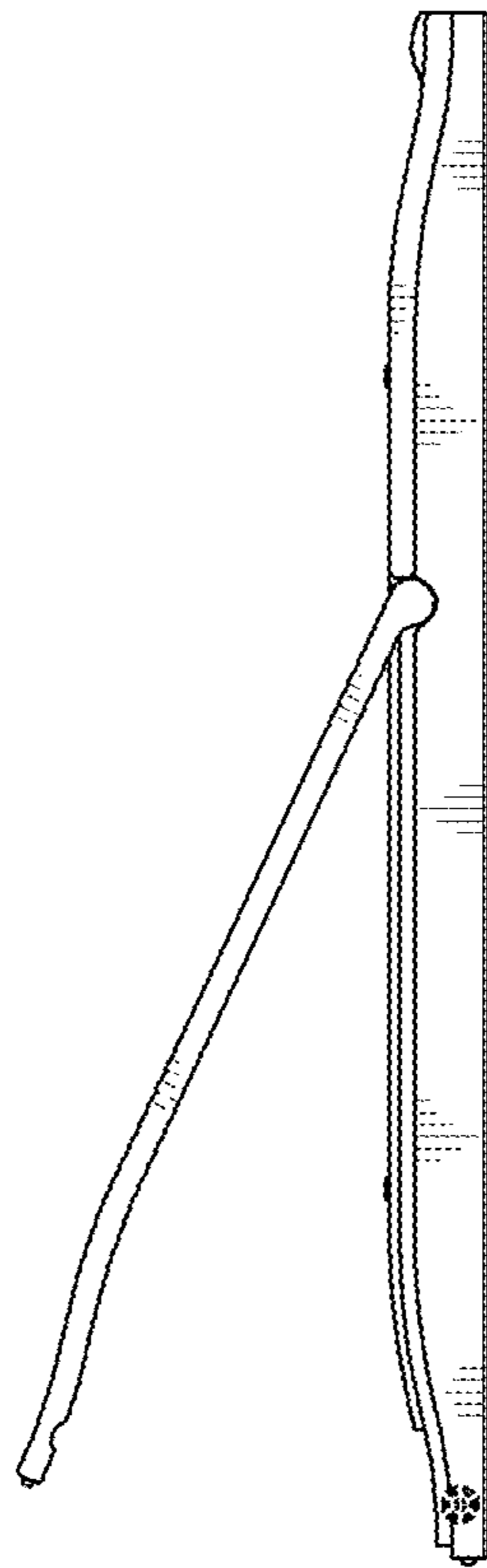

FIG. 12

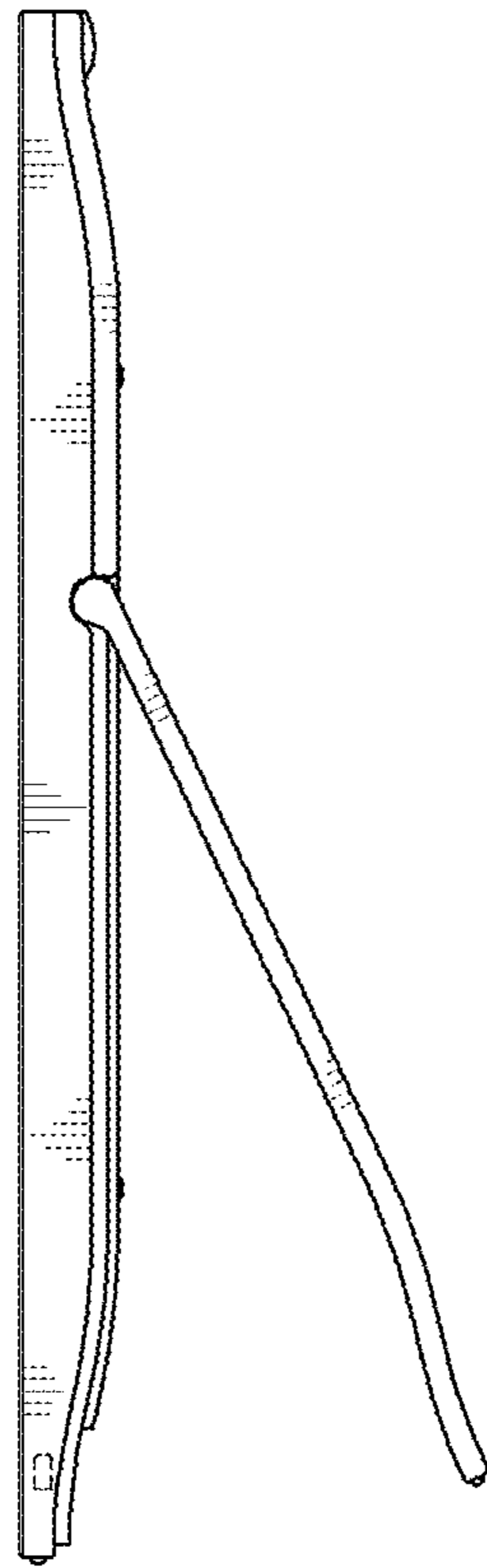

FIG. 13

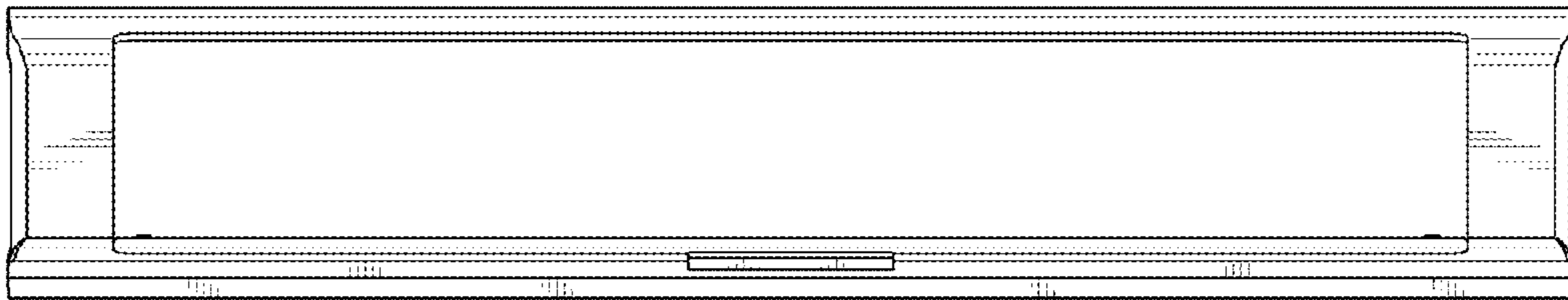

FIG. 14

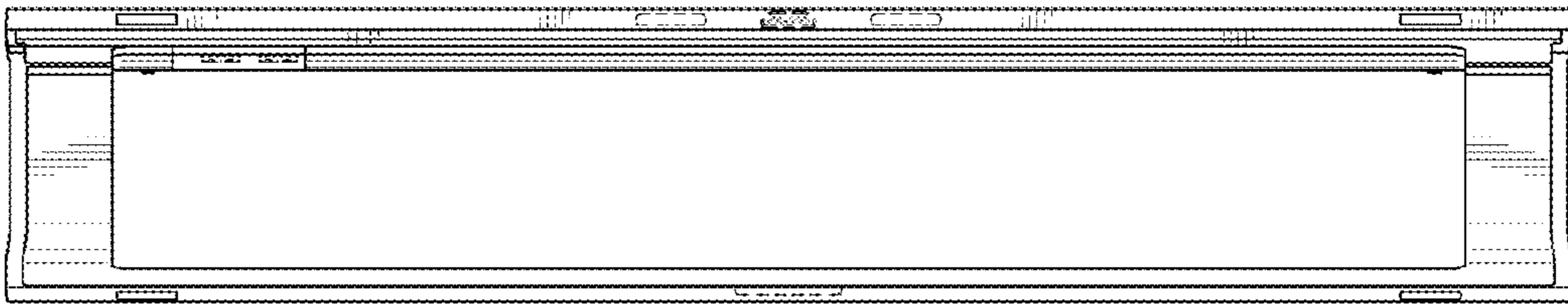



FIG. 15

