



US00D749019S

(12) **United States Design Patent**
Da Cunha et al.

(10) **Patent No.:** **US D749,019 S**
(45) **Date of Patent:** **** Feb. 9, 2016**

(54) **WHEELCHAIR FRAME**

2,634,986 A 4/1953 McDaniel
2,770,832 A 11/1956 Claude
D218,759 S 9/1970 Foster

(71) Applicant: **Invacare International Sarl**, Gland (CH)

(Continued)

(72) Inventors: **Wifrid Da Cunha**, Druye (FR); **Aurelie Lauret**, Lignieres de Touraine (FR); **Mael Robert**, Tours (FR); **Jean-Michel Roncin**, Tours (FR)

FOREIGN PATENT DOCUMENTS

FR 2845893 4/2004

OTHER PUBLICATIONS

(73) Assignee: **INVACARE INTERNATIONAL SARL**, Gland (CH)

Invacare Corporation: "Spirea4 NG"; Rea Spirea4ND-EU-06/2011.
(Continued)

(**) Term: **14 Years**

Primary Examiner — Susan Bennett Hattan

(21) Appl. No.: **29/516,960**

Assistant Examiner — Charles Hanson

(22) Filed: **Feb. 9, 2015**

(74) *Attorney, Agent, or Firm* — Calfee, Halter & Griswold LLP

(57) **CLAIM**

The ornamental design for a wheelchair frame, as shown and described.

Related U.S. Application Data

(62) Division of application No. 29/444,300, filed on Jan. 29, 2013, now Pat. No. Des. 722,286.

DESCRIPTION

(30) **Foreign Application Priority Data**

Jul. 31, 2012 (WO) 683407601

(51) **LOC (10) Cl.** **12-12**

(52) **U.S. Cl.**
USPC **D12/133**

(58) **Field of Classification Search**
USPC D12/131, 133
CPC A61G 5/00-5/14
See application file for complete search history.

FIG. 1 is a front perspective view of a wheelchair frame of the new design;
FIG. 2 is a front elevational view of the wheelchair frame of FIG. 1;
FIG. 3 is a rear elevational view of the wheelchair frame of FIG. 1;
FIG. 4 is a right side elevational view of the wheelchair frame of FIG. 1;
FIG. 5 is a left side elevational view of the wheelchair frame of FIG. 1;
FIG. 6 is a top plan view of the wheelchair frame of FIG. 1; and,
FIG. 7 is a bottom plan view of the wheelchair frame of FIG. 1.

The portions of the Figures shown in broken lines are for illustrative purpose only and form no part of the claimed design.

(56) **References Cited**

U.S. PATENT DOCUMENTS

D114,527 S 5/1939 Boden
2,181,722 A 11/1939 Butter et al.
2,481,948 A 9/1949 Pruitt
2,490,560 A 12/1949 Urquhar, Jr.

1 Claim, 5 Drawing Sheets

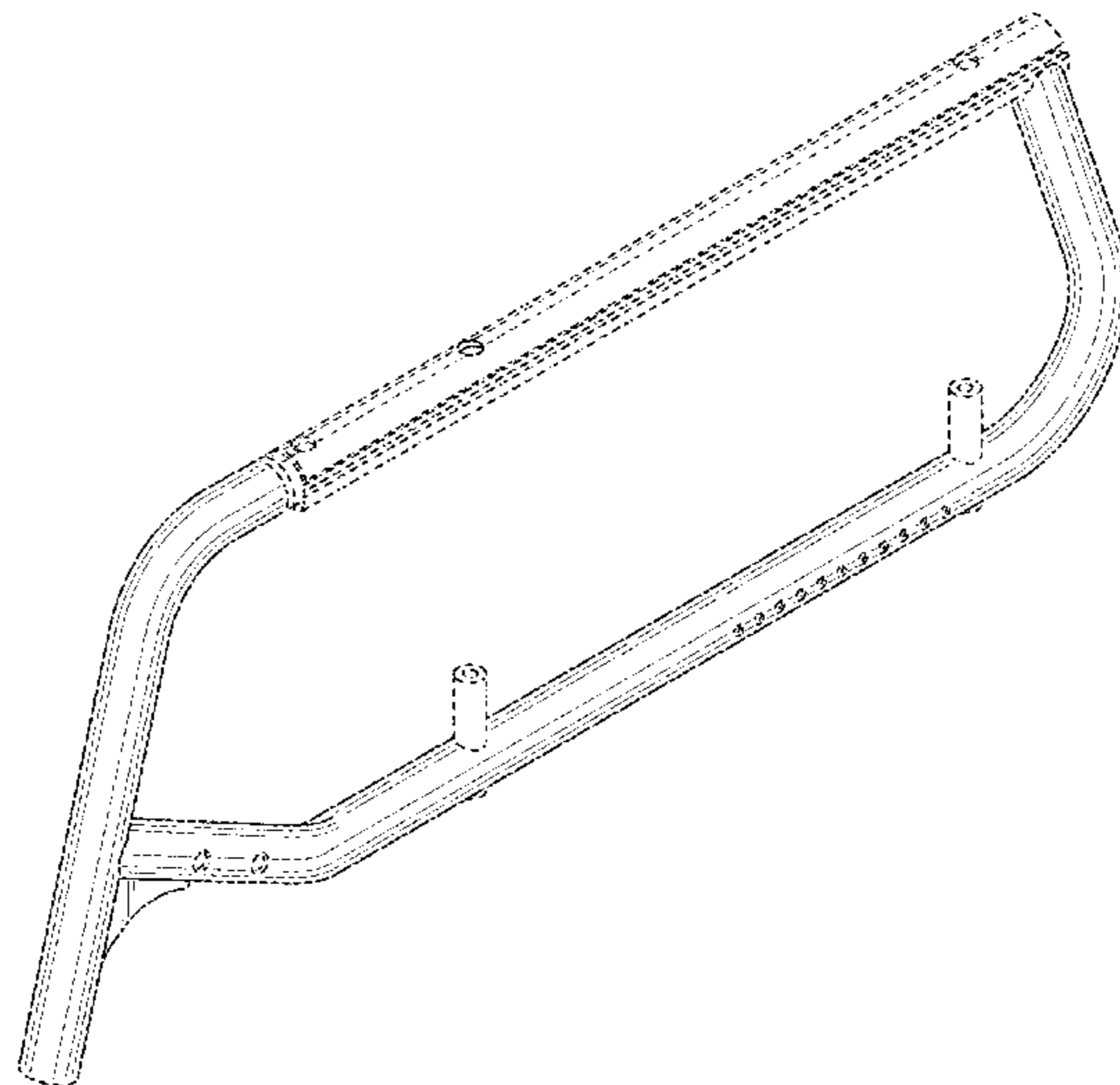

(56)

References Cited

U.S. PATENT DOCUMENTS

3,718,942 A 3/1973 Arenson
 D231,801 S * 6/1974 Pivacek D12/133
 3,865,427 A 2/1975 Delany
 4,025,112 A 5/1977 Hale
 4,592,570 A 6/1986 Nassiri
 4,721,321 A 1/1988 Haury et al.
 4,793,022 A 12/1988 Raffaeli
 4,961,610 A 10/1990 Reeder et al.
 D315,463 S 3/1991 Spiegel
 5,018,788 A 5/1991 Cedergreen
 5,033,792 A 7/1991 Kanazawa
 5,160,156 A 11/1992 Mendon
 5,176,393 A 1/1993 Robertson et al.
 D333,737 S 3/1993 Adams
 D337,289 S 7/1993 Constantine et al.
 D339,315 S 9/1993 Lindkvist et al.
 5,254,007 A 10/1993 Eagan
 D341,344 S 11/1993 Counts et al.
 5,275,466 A 1/1994 Rentchler, Jr.
 5,294,172 A 3/1994 Dubus
 5,366,037 A 11/1994 Richey
 5,421,692 A 6/1995 Varrichio et al.
 5,427,398 A 6/1995 Weybrecht
 D365,786 S 1/1996 Peterson
 D365,787 S 1/1996 Peterson et al.
 D365,788 S 1/1996 Peterson
 D380,991 S 7/1997 Deming
 D383,911 S 9/1997 Conforti
 5,820,221 A 10/1998 Greaves et al.
 D401,540 S 11/1998 Yamamoto
 D403,280 S 12/1998 Diestel
 D412,141 S 7/1999 Dickie et al.
 D414,453 S 9/1999 Tsai
 6,003,891 A 12/1999 Broadhead
 6,015,190 A 1/2000 Wend
 D427,949 S 7/2000 Schlangen
 D431,502 S 10/2000 Schlangen
 D433,968 S 11/2000 Mascari et al.
 6,202,773 B1 3/2001 Richey, II et al.
 6,352,273 B1 3/2002 Dickie
 D455,376 S 4/2002 Lindenkamp
 6,386,638 B1 5/2002 Strauch
 6,425,597 B1 7/2002 Peterson
 D462,639 S 9/2002 Lin
 6,459,962 B2 10/2002 Ulrich et al.
 D468,669 S 1/2003 Hopely, Jr.
 D477,261 S 7/2003 Lin
 6,615,937 B2 9/2003 Richey, II et al.
 6,669,299 B2 12/2003 Carlson et al.
 D486,762 S 2/2004 He
 D489,653 S 5/2004 Tsai
 D491,115 S 6/2004 Taylor
 D491,494 S 6/2004 Lippert
 D494,110 S 8/2004 Cheng
 6,926,106 B2 8/2005 Richey, II et al.
 6,938,923 B2 9/2005 Mulhern et al.
 D521,909 S 5/2006 Gillett et al.
 7,040,429 B2 5/2006 Molnar
 D523,788 S 6/2006 Jones et al.
 D524,196 S 7/2006 You
 D529,844 S 10/2006 Chen et al.
 D536,187 S 2/2007 Goebert et al.
 D536,887 S 2/2007 Goebert et al.
 D540,221 S 4/2007 Cartellone et al.
 7,204,556 B2 4/2007 Schwerdtner et al.
 7,229,132 B2 6/2007 Meeker et al.
 7,231,689 B2 6/2007 Scheiber et al.
 D559,741 S 1/2008 Lasher, III
 7,353,566 B2 4/2008 Scheiber et al.
 D569,769 S 5/2008 Chiu et al.
 7,370,876 B2 5/2008 Hsu et al.
 D573,861 S 7/2008 Hammer
 7,413,045 B2 8/2008 Tien
 7,472,959 B1 1/2009 Ratza et al.
 D585,794 S 2/2009 Lin

D588,051 S 3/2009 Moller et al.
 D589,411 S 3/2009 Brown et al.
 D590,304 S 4/2009 Kruse
 D602,404 S 10/2009 Cusack
 D608,550 S 1/2010 Sollberger et al.
 D614,541 S 4/2010 Storm
 7,694,991 B2 4/2010 Mills
 D615,461 S 5/2010 Storm
 D622,641 S 8/2010 Chen et al.
 D627,271 S 11/2010 Knopf
 D631,403 S 1/2011 Knopf
 7,866,613 B2 1/2011 Cramer
 D632,229 S 2/2011 Kruse
 D636,299 S 4/2011 Knopf
 D642,499 S 8/2011 Tuckowski et al.
 D642,500 S 8/2011 Tuckowski et al.
 D642,963 S 8/2011 Greiner
 8,065,051 B2 11/2011 Chopcinski et al.
 8,073,588 B2 12/2011 Peters et al.
 D652,357 S 1/2012 Jurkiewicz et al.
 D653,176 S 1/2012 Jurkiewicz et al.
 D654,408 S 2/2012 Spalding et al.
 D656,070 S 3/2012 Spalding et al.
 D682,748 S 5/2013 Horacek
 D690,190 S 9/2013 McGrath
 D703,107 S 4/2014 Moller
 D720,666 S 1/2015 Farmer
 D721,017 S 1/2015 Spalding
 D722,286 S * 2/2015 Da Cunha D12/133
 D731,366 S 6/2015 Gingrass
 D731,931 S * 6/2015 Gingras D12/133
 8,727,048 B2 6/2015 Jurkiewicz et al.
 D735,622 S 8/2015 Spalding
 2001/0013437 A1 8/2001 Husted et al.
 2003/0056329 A1 3/2003 Coman et al.
 2004/0239169 A1 12/2004 De Nichilo
 2006/0082098 A1 4/2006 Harris
 2007/0107963 A1 5/2007 Chiu
 2007/0195081 A1 8/2007 Fischer
 2008/0087481 A1 4/2008 Gry
 2009/0172915 A1 7/2009 Hunziker
 2010/0212108 A1 8/2010 Yang et al.
 2011/0131761 A1 6/2011 Campbell

OTHER PUBLICATIONS

Invacare Corporation, At'm (Take Along Chair), 2 page brochure, copyright 2009.
 Invacare Corporation, FDX Front-Wheel Drive Power Wheelchair, 4 page brochure, copyright 2010.
 Invacare Corporation, Nutron R51, 2 page brochure, copyright 2006.
 Invacare Corporation, P9000 XDT, 2 page brochure, copyright 2007.
 Invacare Corporation, Pronto M51, 4 page brochure, copyright 2010.
 Invacare Corporation, Pronto M51 with Formula CG Seating, 2 page web printout, printed Feb. 18, 2011.
 Invacare Corporation, The New TDX Family, 26 page brochure, copyright 2008.
 Invacare Corporation, Storm Series, 16 page brochure, copyright 2010.
 Invacare Corporation, User Manual, FDX Power Wheelchair Base FDX, FDX-CG, FDX-MCG, 96 pgs., Rev A, 09/10. copyright 2010.
 Invacare Corporation, Operator and Maintenance Manual, Pronto M51 and M561 with SureStep, 80 pgs., Rev. J-10/08, copyright 2008.
 International Search Report and Written Opinion from PCT/US2011/28626, dated May 20, 2011.
 Invacare Corporation, Product Brochure, "IVC" Standard Manual Wheelchairs, 30 pages; Form No. 00-261; Rev. 04/11.
 Invacare Corporation—Product Catalog, Tilt-in-Space, website printout; http://invacare.com/cgi-bin/imhqprd/inv_catalog/prod_cat.jsp?catOID=536885269; 2 pages; copyright 2013.
 Invacare Corporation—Product Catalog, IVC Manual Wheelchairs; website printout: http://invacare.com/cgi-bin/imhqprd/inv_catalog/prod_cat.jsp?catOID=536885295, 3 pages; copyright 2013.
 Invacare Corporation—Product Catalog, Custom Manual Wheelchairs; website printout: http://invacare.com/cgi-bin/imhqprd/inv_catalog/prod_cat.jsp?catOID=536885343; 1 page; copyright 2013.

(56)

References Cited

OTHER PUBLICATIONS

Invacare Corporation—Product Catalog, Top End Everyday Chairs; website printout: http://invacare.com/cgi-bin/imhqprd/inv_catalog/prod_cat.jsp?catOID=536885323; 2 pages; copyright 2013.

Invacare Corporation—Product Catalog, IVC Manual; website printout: [http://invacare.com/cgi-bin/imhqprd/inv_catalog/prod_cat.jsp?s=\)&sideButCatEdn . . .](http://invacare.com/cgi-bin/imhqprd/inv_catalog/prod_cat.jsp?s=)&sideButCatEdn...); 3 pages; copyright 2013.

Invacare Corporation—Product Brochure; The Rea Focus; EU-05/2012; 6 pages.

Invacare Corporation—Product Brochure; Rea Spirea 2-EU-06/2011; 4 pages.

Invacare Corporation—Product Brochure; The Invacare Spin; SpinX-EU-06/2011; 4 pages.

Invacare Corporation—Product Brochure; The Invacare Topaz; Topaz-EU-06/2011; 2 pages.

Invacare Corporation—Product Brochure; The Invacare Alu Lite; Alu Lite-EU-06/2011; 2 pages.

Invacare Corporation; “Action NG Family Accessories Brochure”; The Invacare Action NG; The changing face of mobility; Action NG Accessories-EU-05/2012; 8 pages.

Invacare Corporation; “Action 1 NG”; EU-11/2012; 4 pages.

Invacare Corporation, product Catalog, copyright 2004, printed Feb. 18, 2011, 14 pages.

* cited by examiner

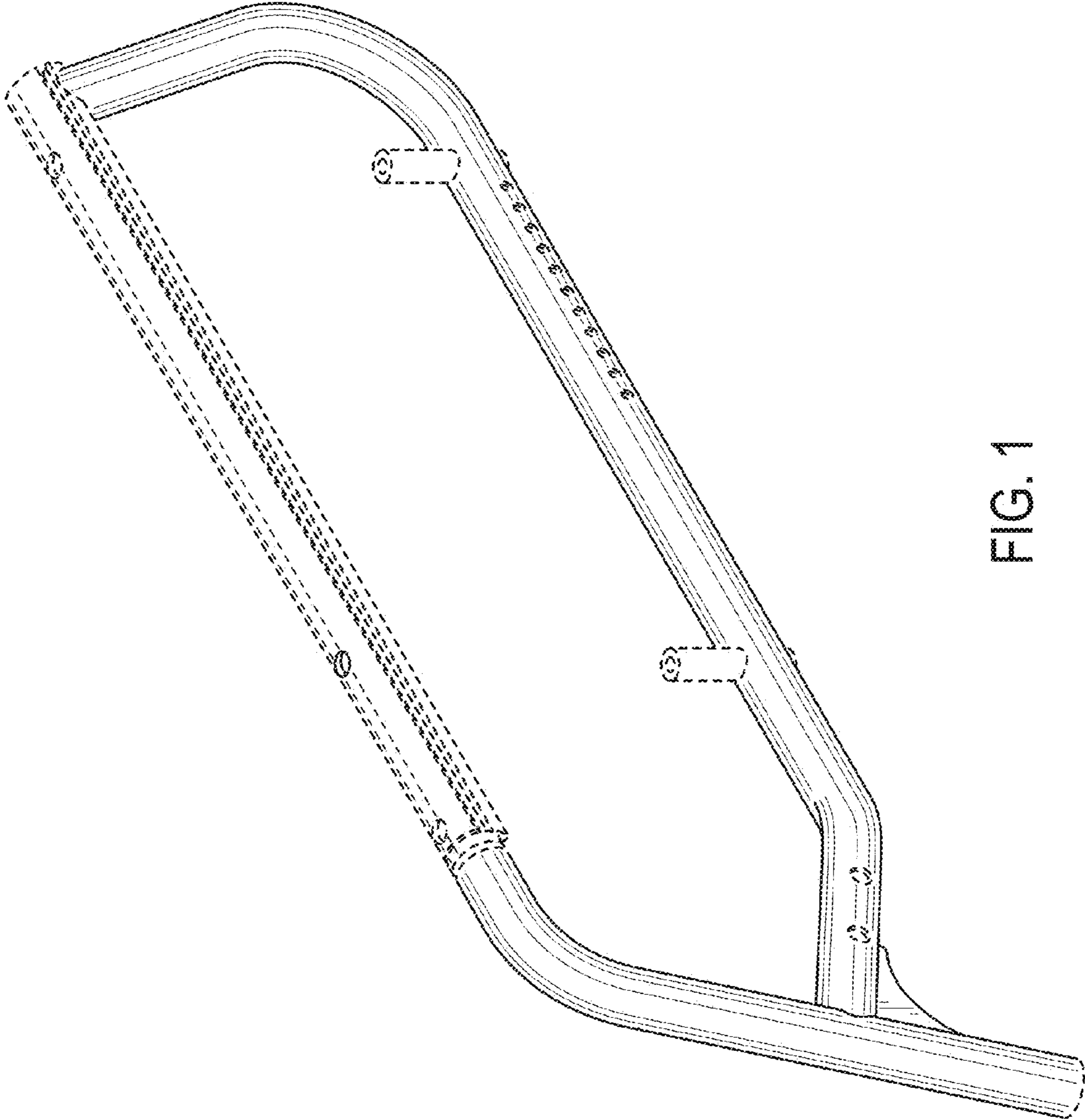

FIG. 1

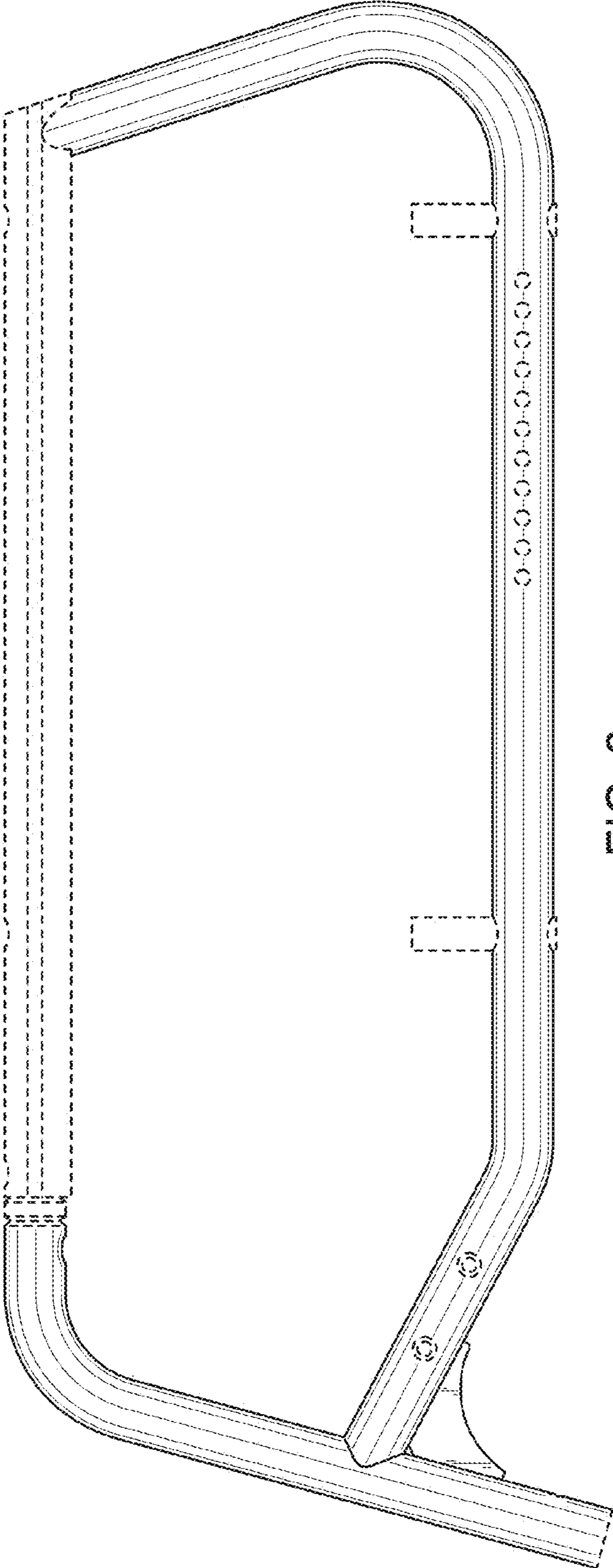

FIG. 2

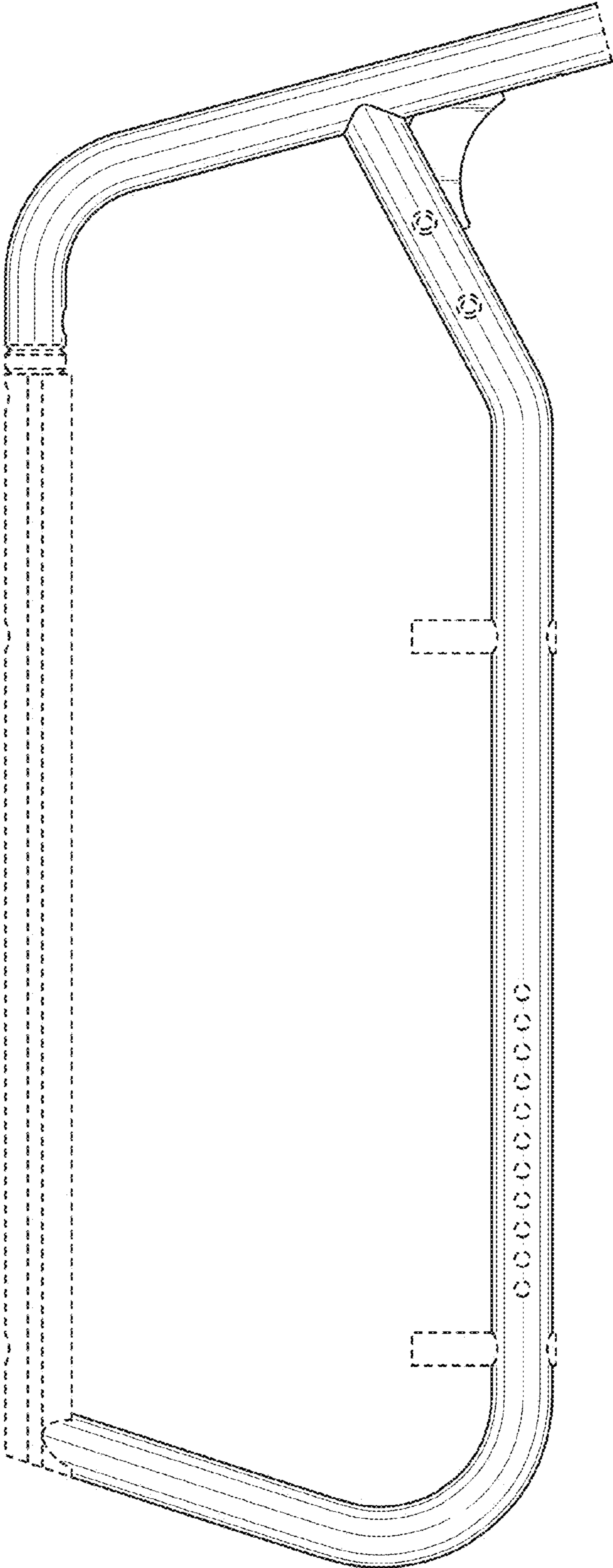

FIG. 3

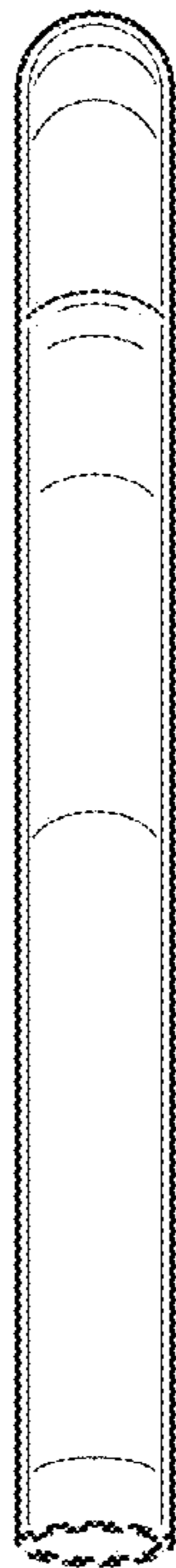

FIG. 4

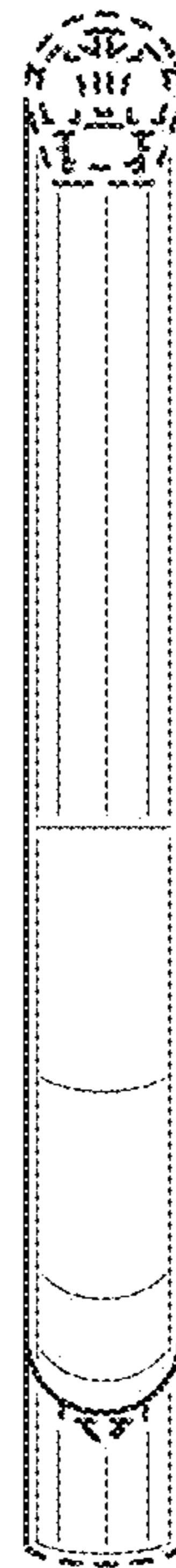

FIG. 5

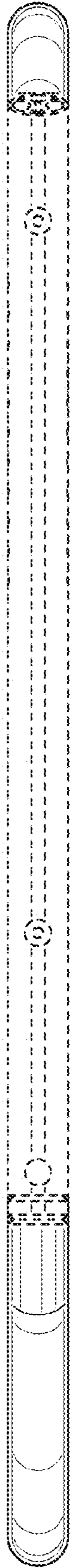

FIG. 6

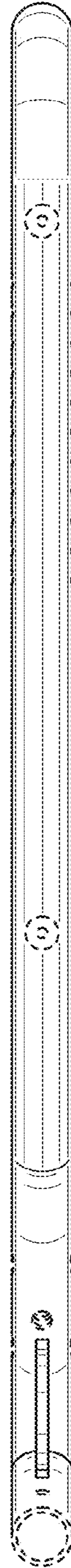

FIG. 7