



US00D748988S

(12) **United States Design Patent**  
**Marotti et al.**

(10) **Patent No.:** **US D748,988 S**  
(45) **Date of Patent:** **\*\* Feb. 9, 2016**

- (54) **BOTTLE WITH LABEL**
- (71) Applicant: **The Procter & Gamble Company,**  
Cincinnati, OH (US)
- (72) Inventors: **Martin Jay Marotti,** Carmel, IN (US);  
**Juan Carlos Vinseiro,** Cincinnati, OH  
(US)
- (73) Assignee: **THE PROCTER & GAMBLE**  
**COMPANY,** Cincinnati, OH (US)
- (\*\*) Term: **14 Years**
- (21) Appl. No.: **29/471,682**
- (22) Filed: **Nov. 4, 2013**

**Related U.S. Application Data**

- (62) Division of application No. 29/401,146, filed on Sep. 8, 2011, now Pat. No. Des. 695,621.
- (51) **LOC (10) Cl.** ..... **09-01**
- (52) **U.S. Cl.**  
USPC ..... **D9/543; D9/571; D9/574**
- (58) **Field of Classification Search**  
USPC ..... D9/516, 530, 541-546, 549, 558,  
D9/571-575, 682, 686-692, 694, 550, 563,  
D9/548, 565, 685, 715, 719; D7/300, 598;  
215/379, 381-382; 220/660, 662, 669,  
220/675; D20/10-11, 22  
CPC ..... B65D 1/00; B65D 1/02; B65D 1/0223;  
B65D 23/00; B65D 81/00; B65D 2501/00;  
B65D 2501/0009; B65D 2501/0081  
See application file for complete search history.

(56) **References Cited**

**U.S. PATENT DOCUMENTS**

- D50,594 S \* 4/1917 Voges ..... D20/40
- D207,350 S \* 4/1967 Koenigsberg ..... D9/542
- D211,005 S \* 5/1968 Vanderhyde ..... D9/542

- D219,097 S \* 11/1970 Beeman ..... D9/543
- D232,146 S \* 7/1974 Dean ..... D5/63
- D237,946 S \* 12/1975 Pardo ..... D9/529
- D339,487 S \* 9/1993 Rizzi ..... D6/696.1
- D355,105 S \* 2/1995 Nemazi ..... D32/40
- D401,086 S \* 11/1998 Hellwig ..... D6/650
- D416,050 S \* 11/1999 Caloia ..... D13/154
- D488,647 S \* 4/2004 Ford ..... D6/696
- D527,824 S \* 9/2006 Mueller ..... D24/189
- D543,384 S \* 5/2007 Resterhouse ..... D6/693.1
- D580,593 S \* 11/2008 Huntington ..... D20/11
- D591,607 S \* 5/2009 Marotti ..... D9/571
- D604,424 S \* 11/2009 Coubetergues ..... D24/189

(Continued)

*Primary Examiner* — Dana L Meyrow

(74) *Attorney, Agent, or Firm* — James E. Oehlenschlager

(57) **CLAIM**

The ornamental design for a bottle with label, as shown and described.

**DESCRIPTION**

FIG. 1 is a front perspective view of a bottle with label showing our new design;  
 FIG. 2 is a front elevation view thereof  
 FIG. 3 is a left side elevation view thereof;  
 FIG. 4 is a right side elevation view thereof;  
 FIG. 5 is a rear elevation view thereof;  
 FIG. 6 is a top plan view thereof;  
 FIG. 7 is a bottom plan view thereof;  
 FIG. 8 is a front perspective view of a second embodiment of a bottle with label showing our new design;  
 FIG. 9 is a front elevation view thereof  
 FIG. 10 is a left side elevation view thereof;  
 FIG. 11 is a right side elevation view thereof;  
 FIG. 12 is a rear elevation view thereof;  
 FIG. 13 is a top plan view thereof; and,  
 FIG. 14 is a bottom plan view thereof.  
 The broken lines in the drawings illustrate the portions of the bottle with label that form no part of the claim.

**1 Claim, 10 Drawing Sheets**

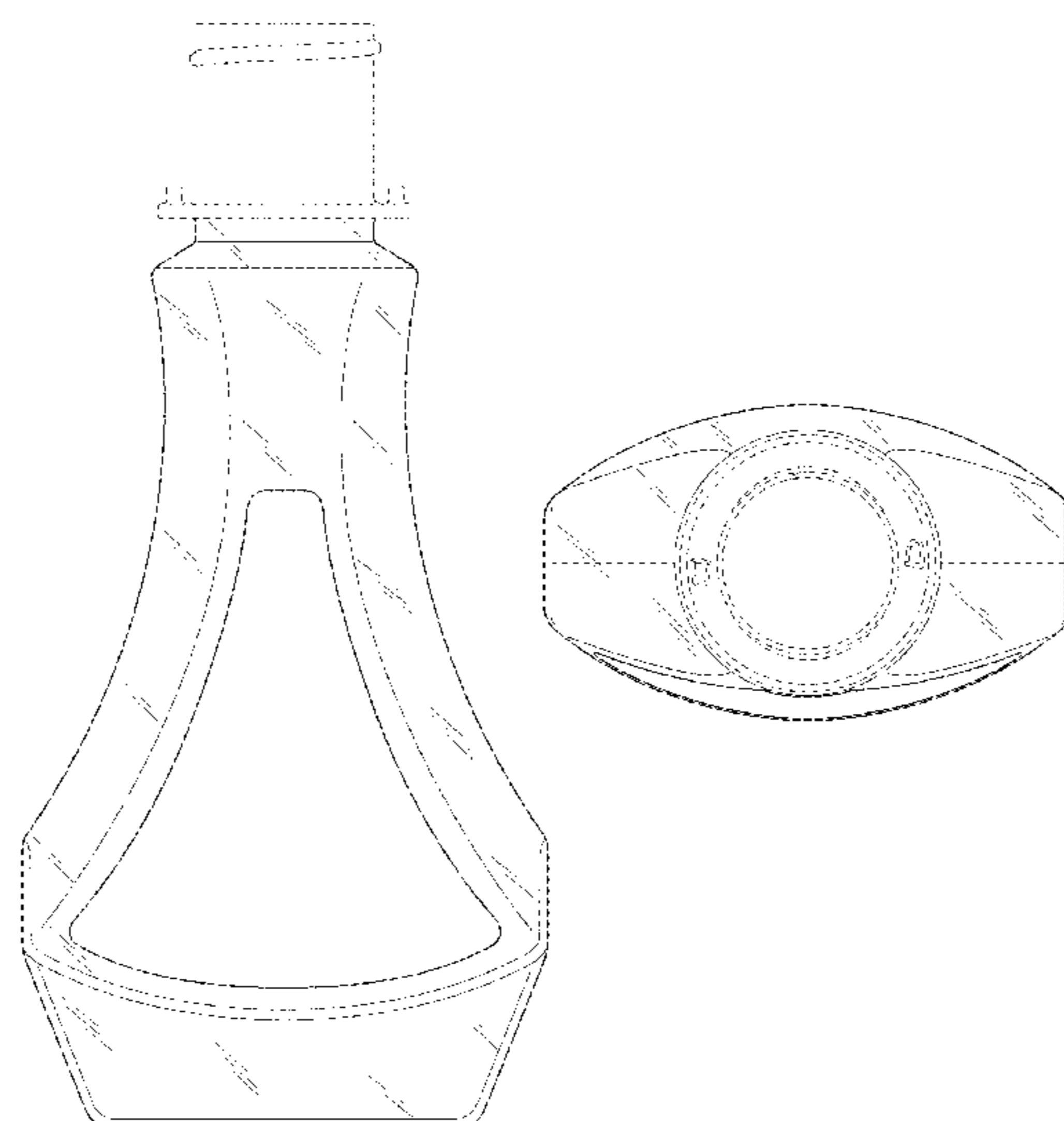

(56)

**References Cited**

U.S. PATENT DOCUMENTS

D623,521 S *	9/2010	Marotti	.....	D9/516	D673,614 S *	1/2013	Murphy	.....	D20/22
D627,651 S *	11/2010	Marotti	.....	D9/516	D676,330 S *	2/2013	Nanda	.....	D9/542
D629,308 S *	12/2010	Marotti	.....	D20/22	D676,761 S *	2/2013	Marotti	.....	D9/696
D650,678 S *	12/2011	Marotti	.....	D20/22	D677,335 S *	3/2013	Murphy	.....	D20/23
D656,828 S *	4/2012	Marotti	.....	D9/516	D691,051 S *	10/2013	Murphy	.....	D20/22
D663,478 S *	7/2012	Tousley	.....	D24/189	D695,621 S *	12/2013	Marotti	.....	D9/542
D673,613 S *	1/2013	Murphy	.....	D20/22	D703,757 S *	4/2014	Murphy	.....	D20/23
					D712,747 S *	9/2014	Marotti	.....	D9/542
					D720,993 S *	1/2015	Marotti	.....	D9/571
					D728,373 S *	5/2015	Marotti	.....	D9/542

\* cited by examiner

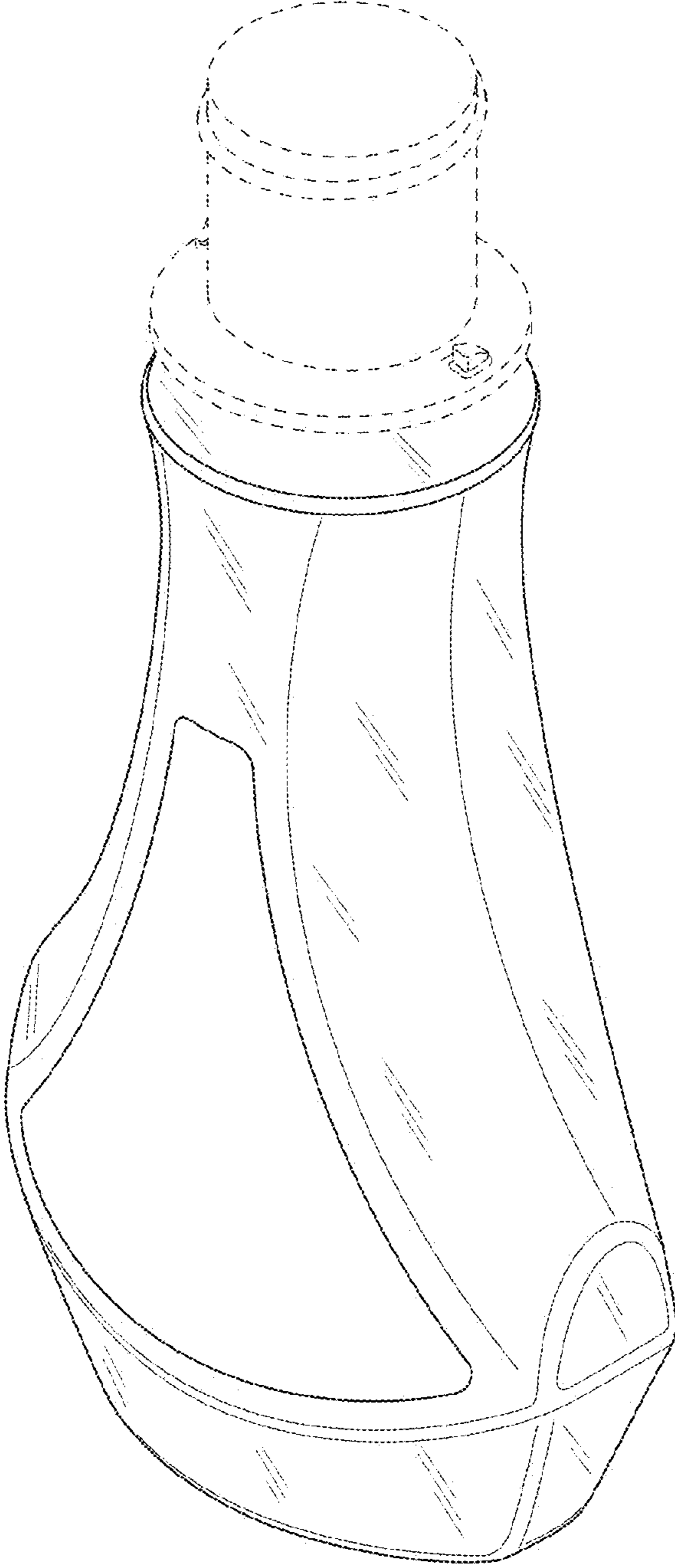

Fig. 1

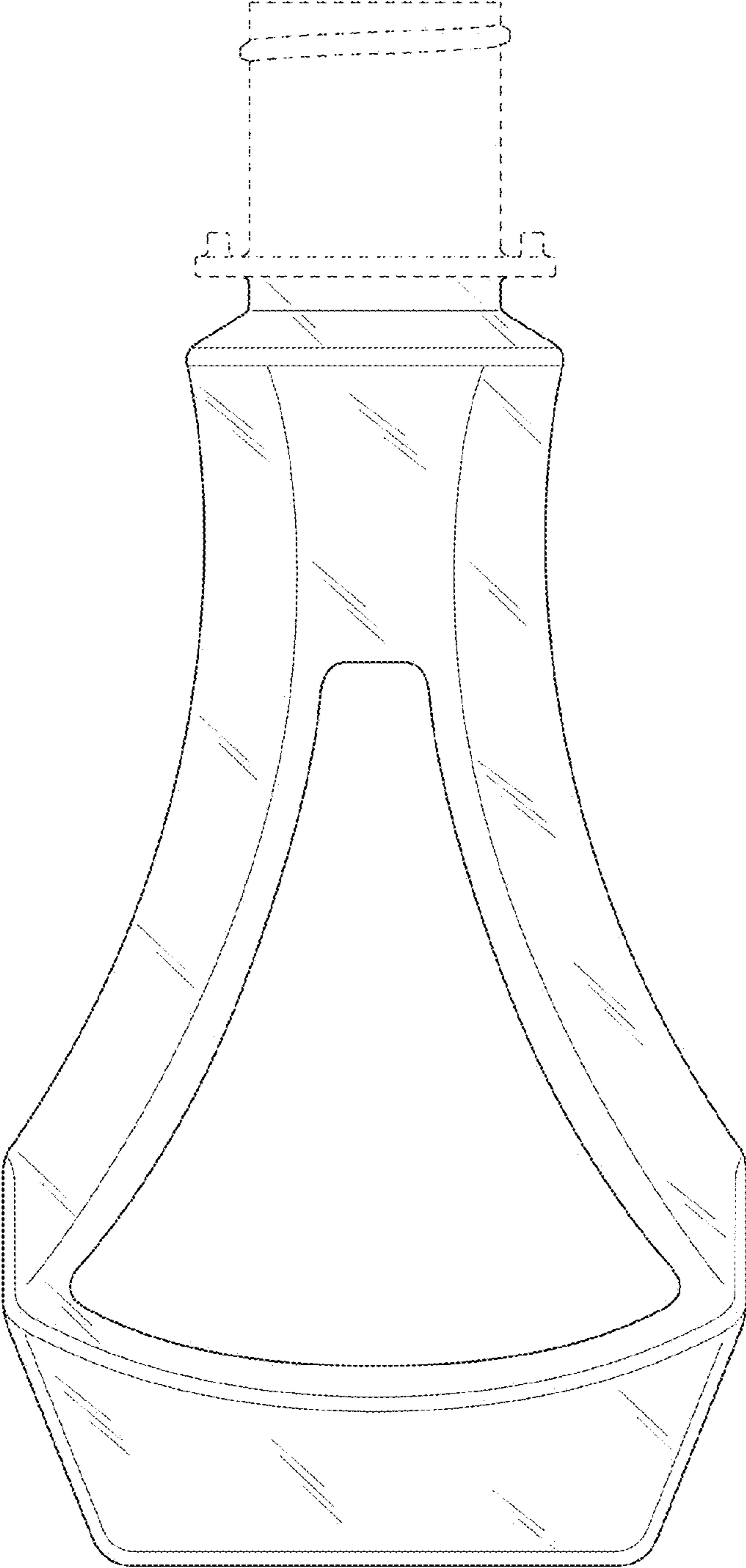

Fig. 2

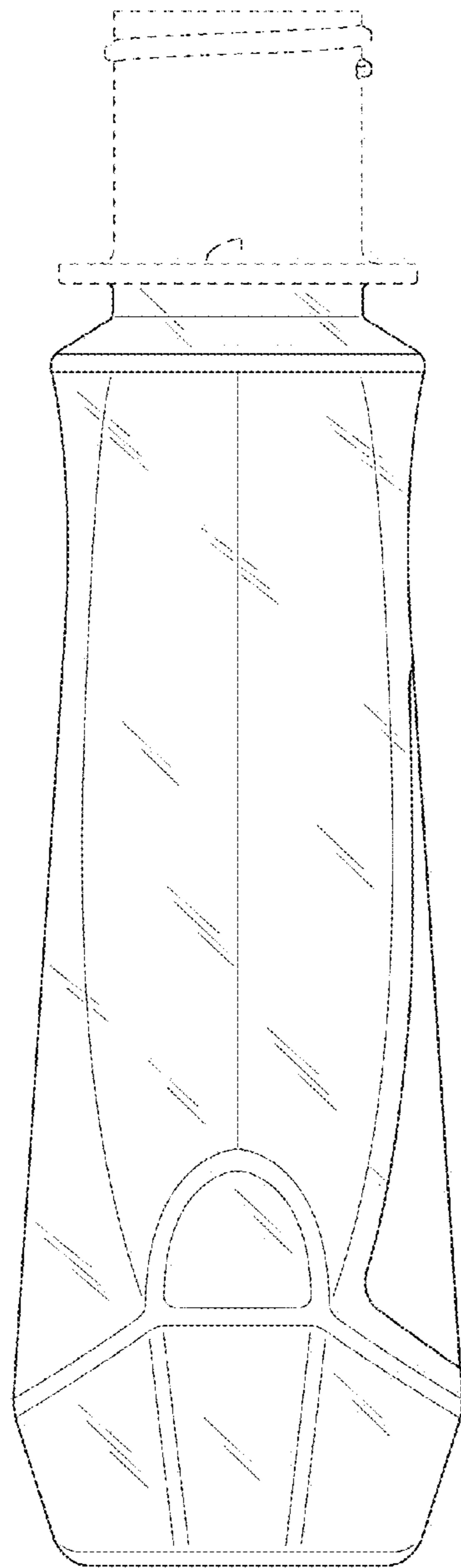

Fig. 3

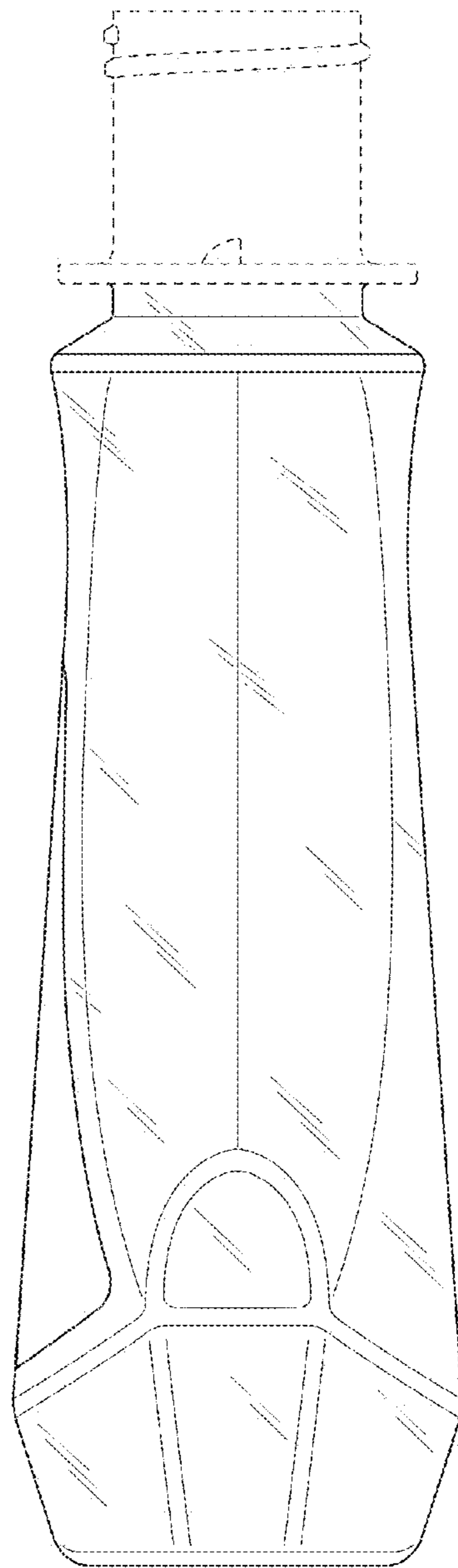

Fig. 4

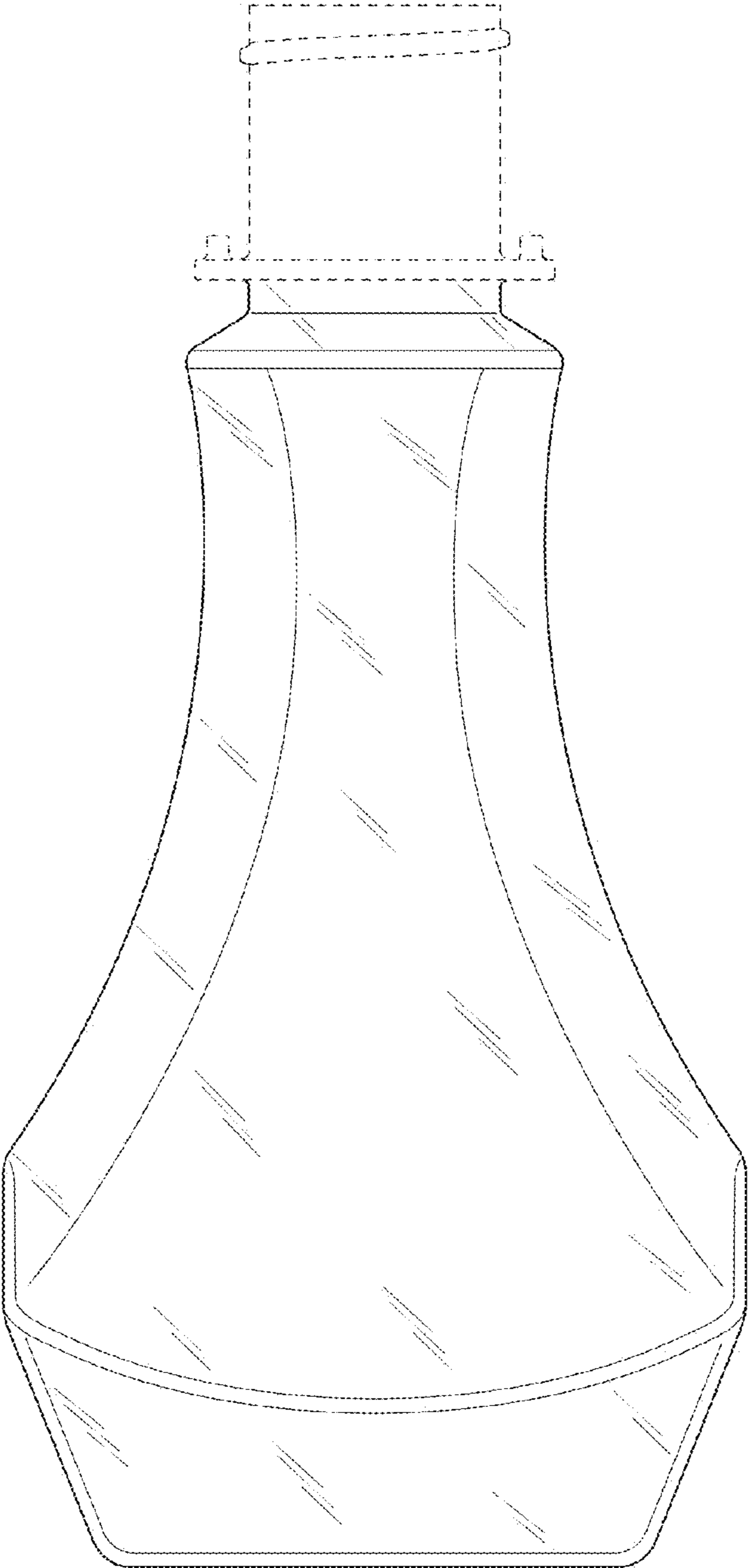

Fig. 5

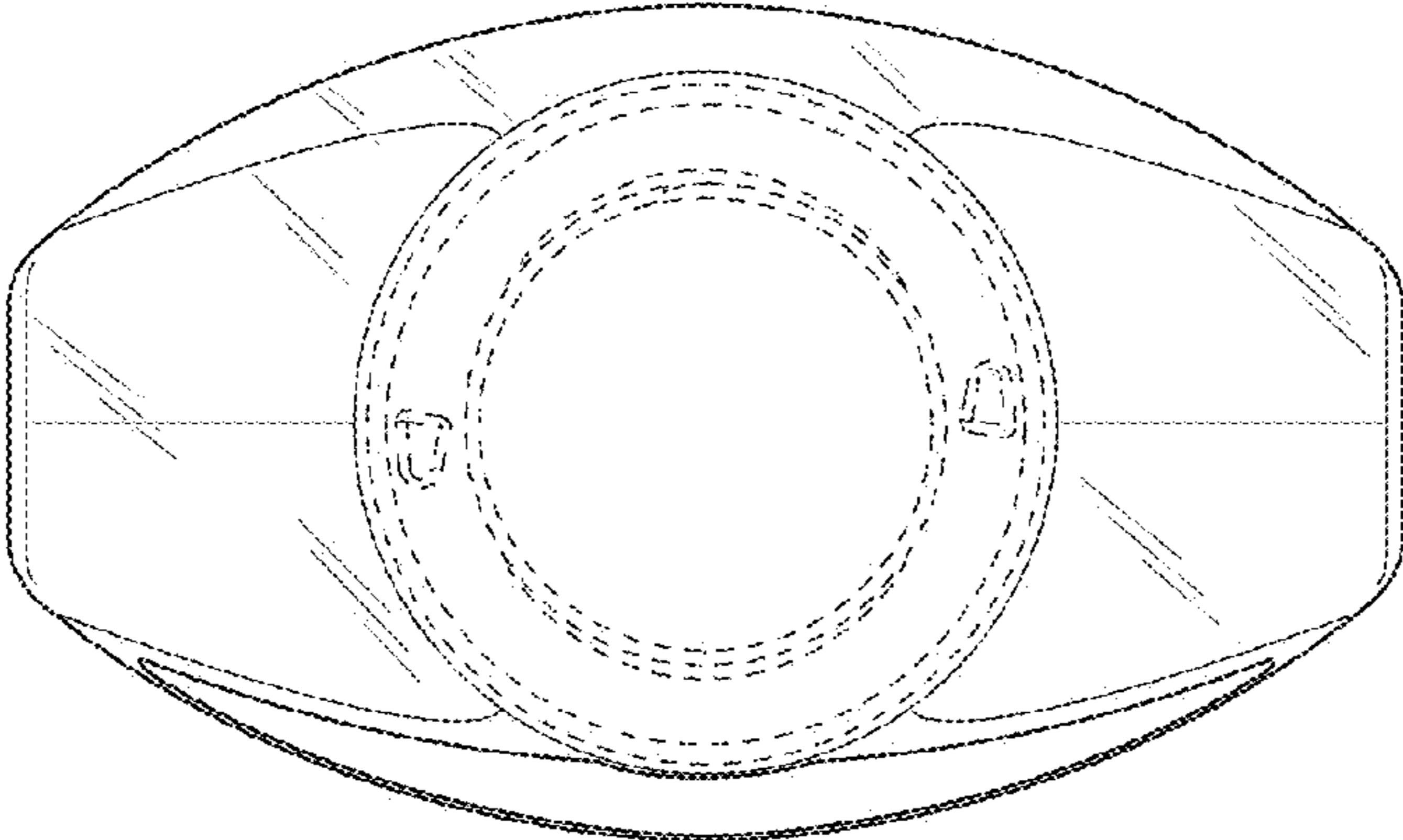

Fig. 6

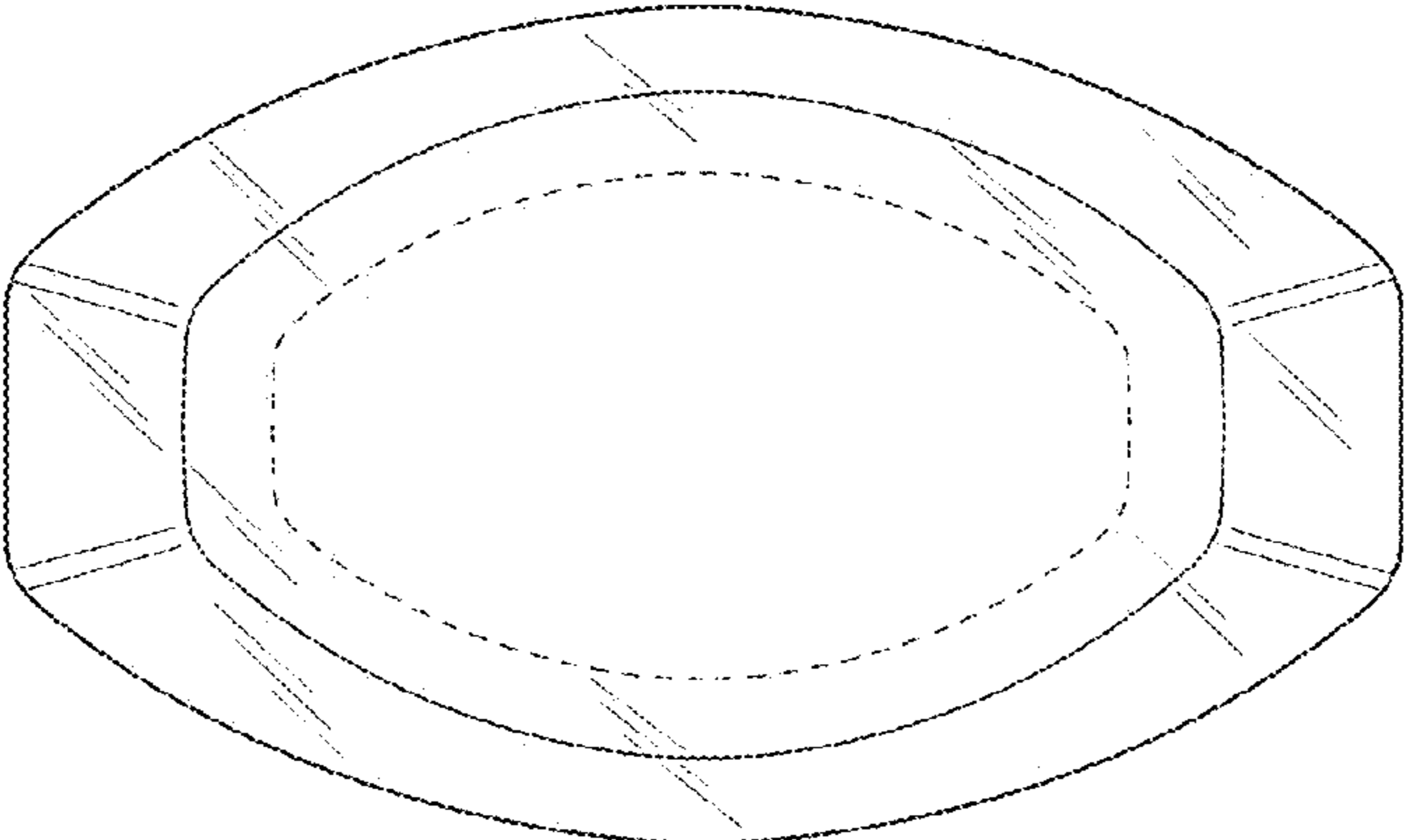

Fig. 7

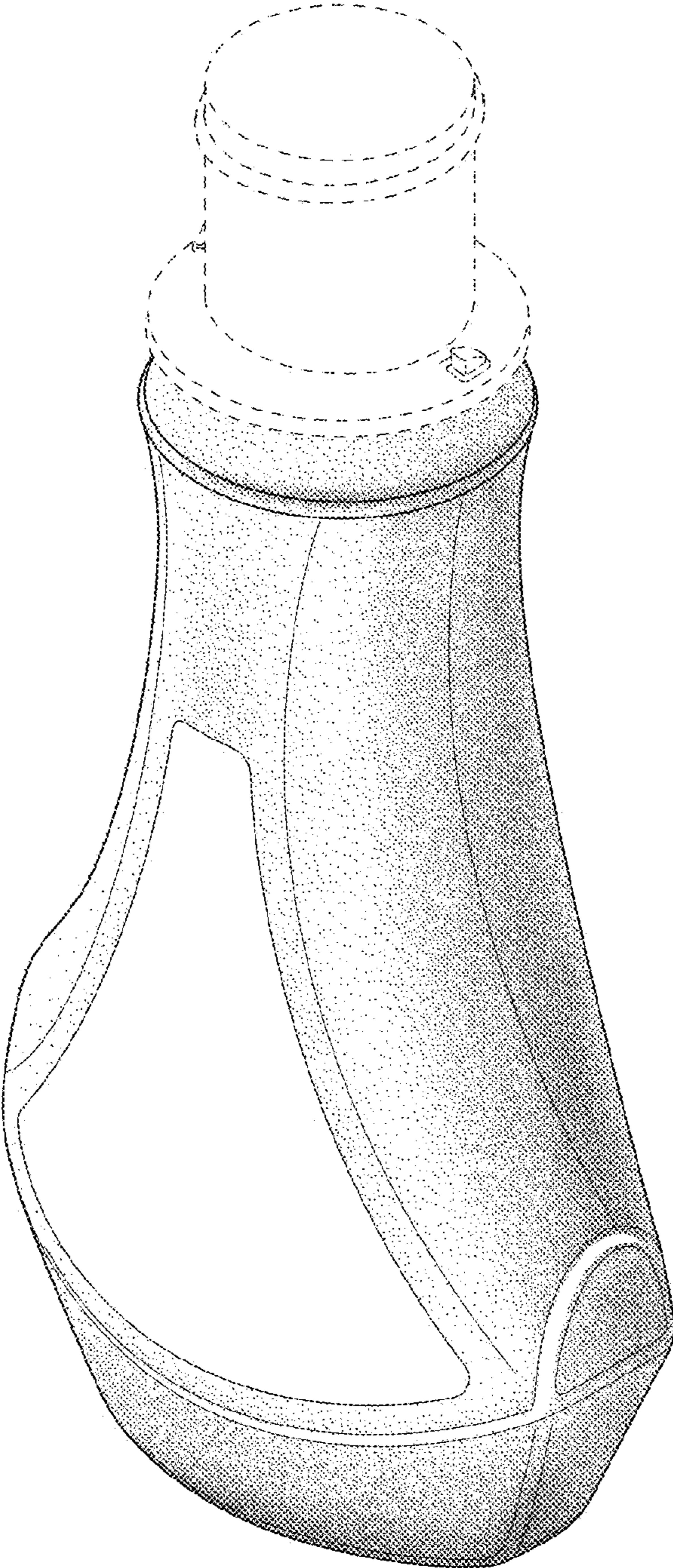

Fig. 8



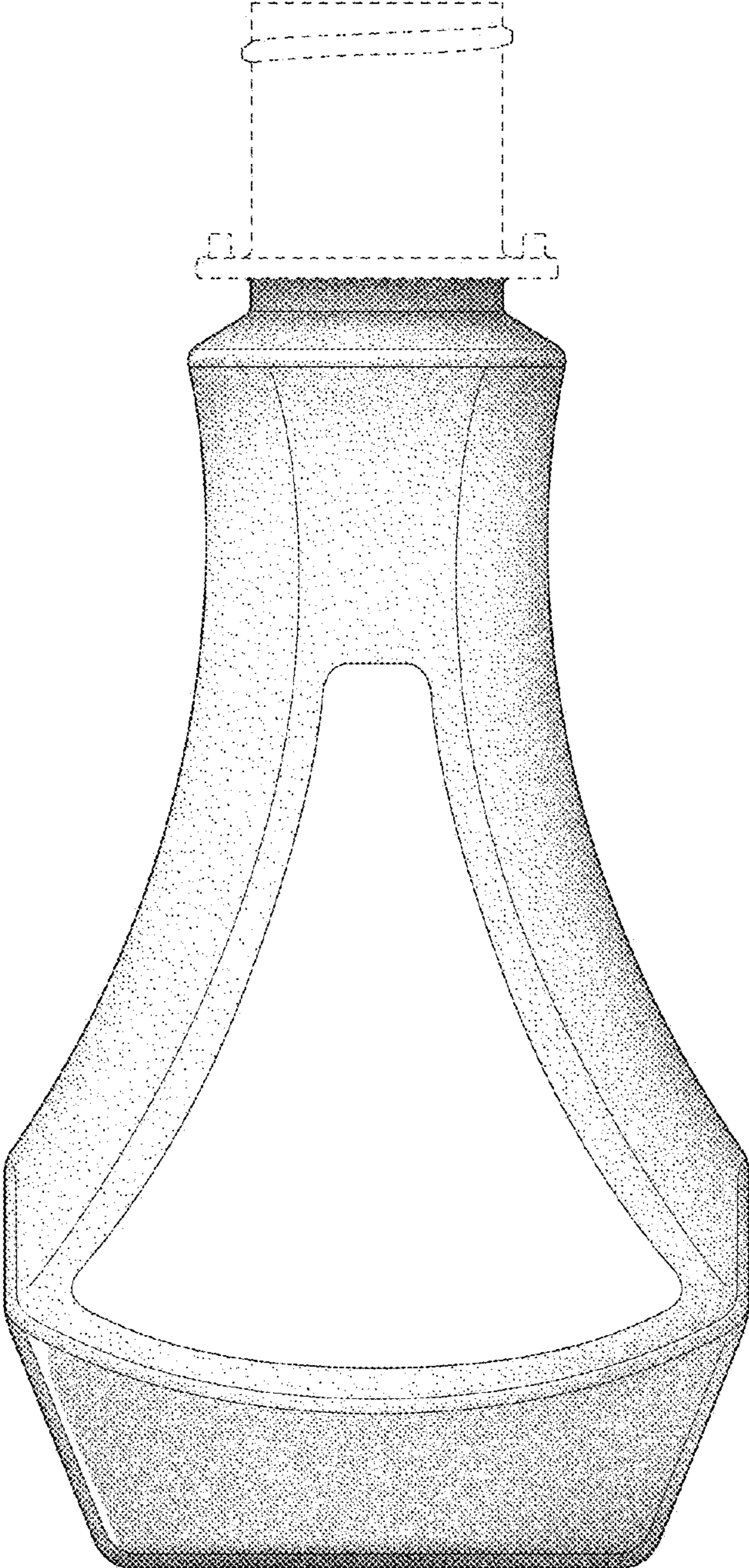

Fig. 9

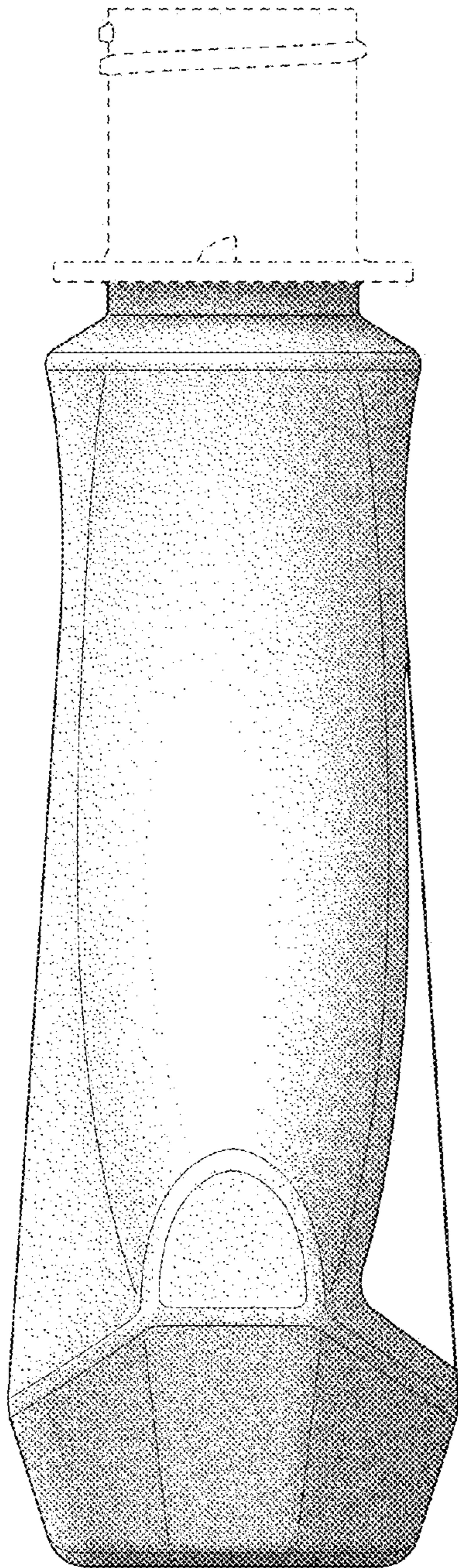

Fig. 10

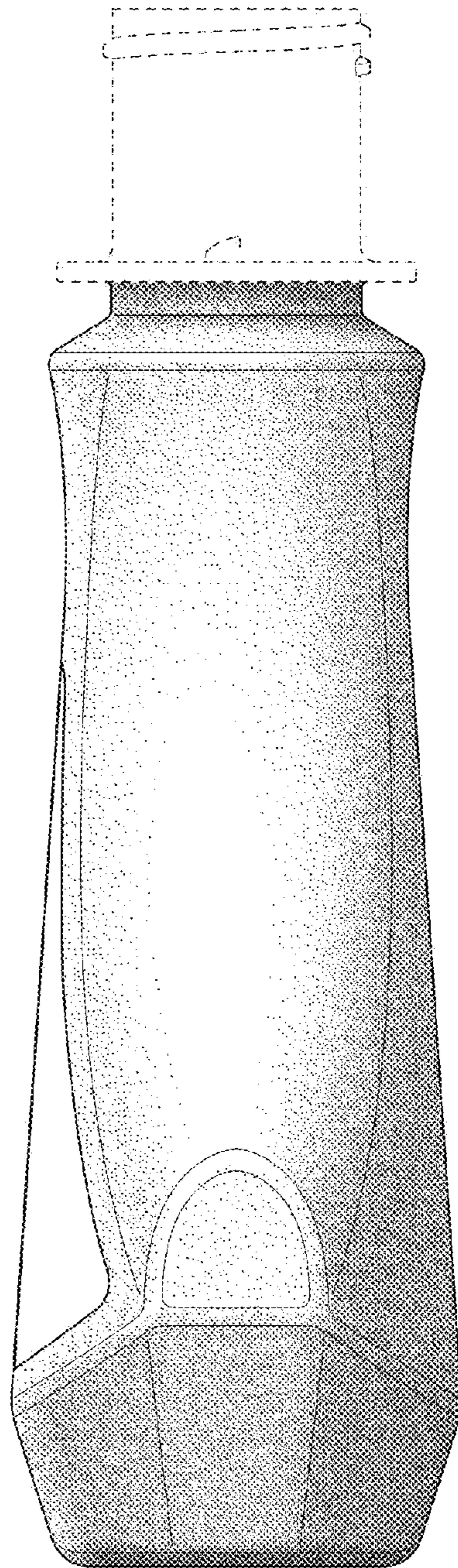

Fig. 11

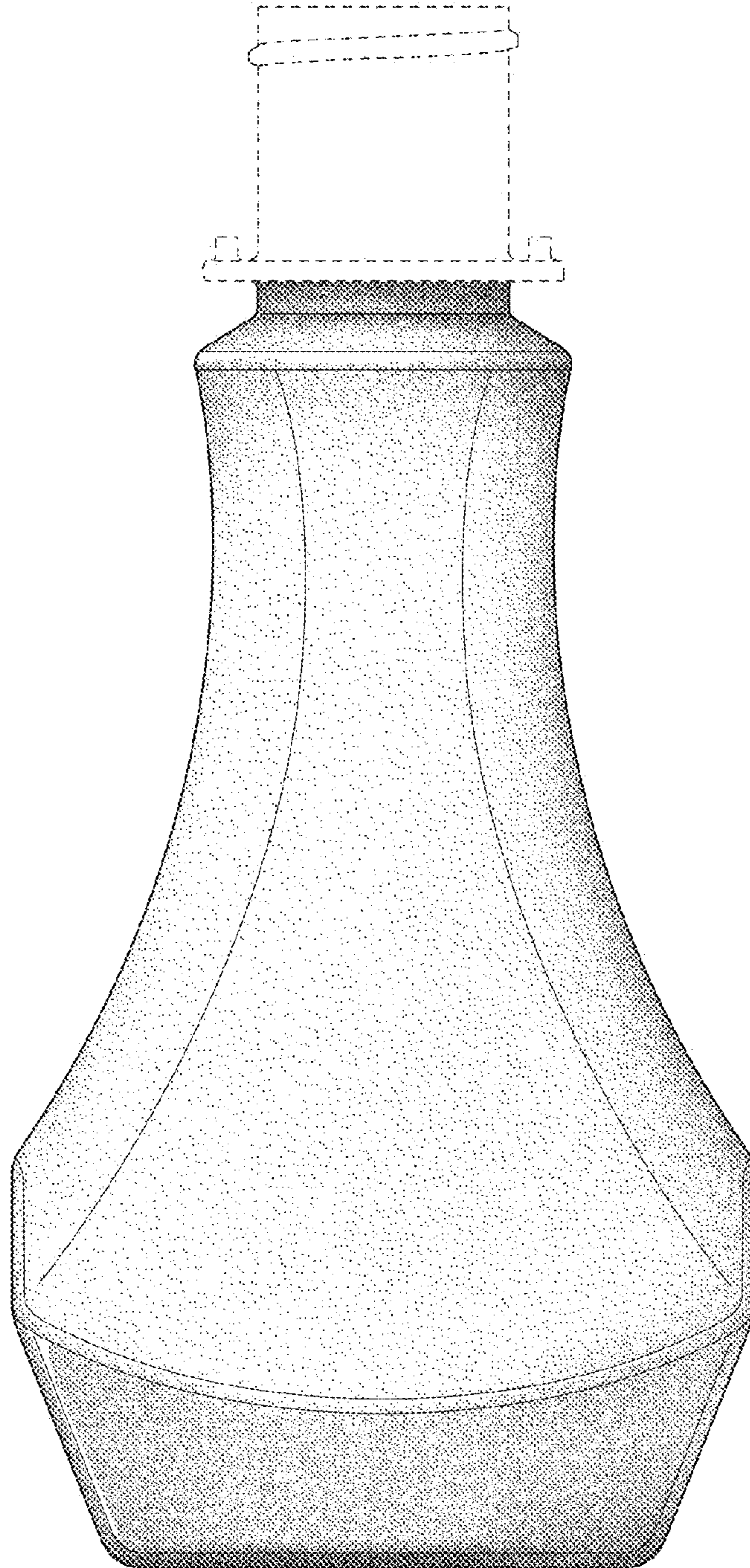

Fig. 12

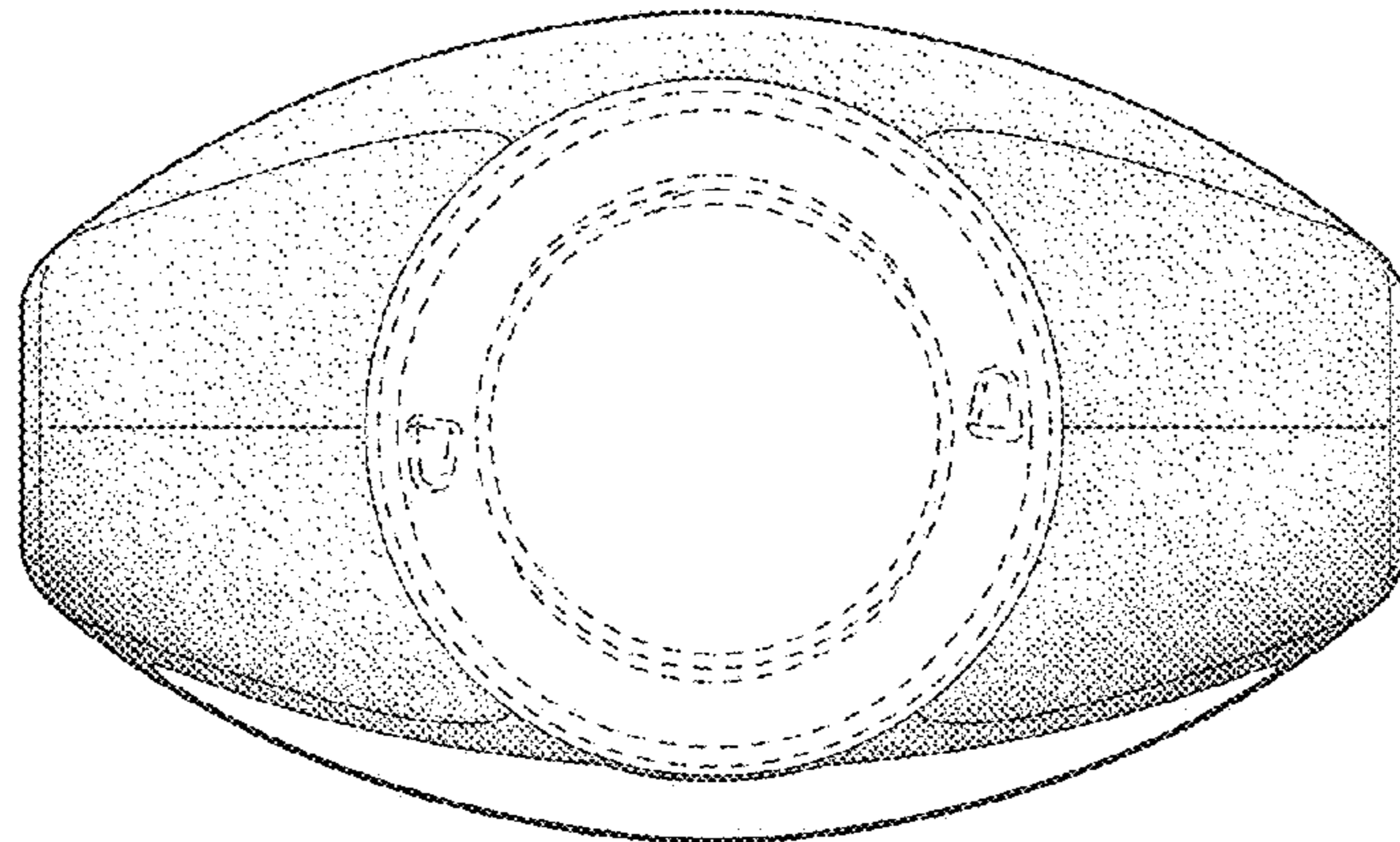

Fig. 13

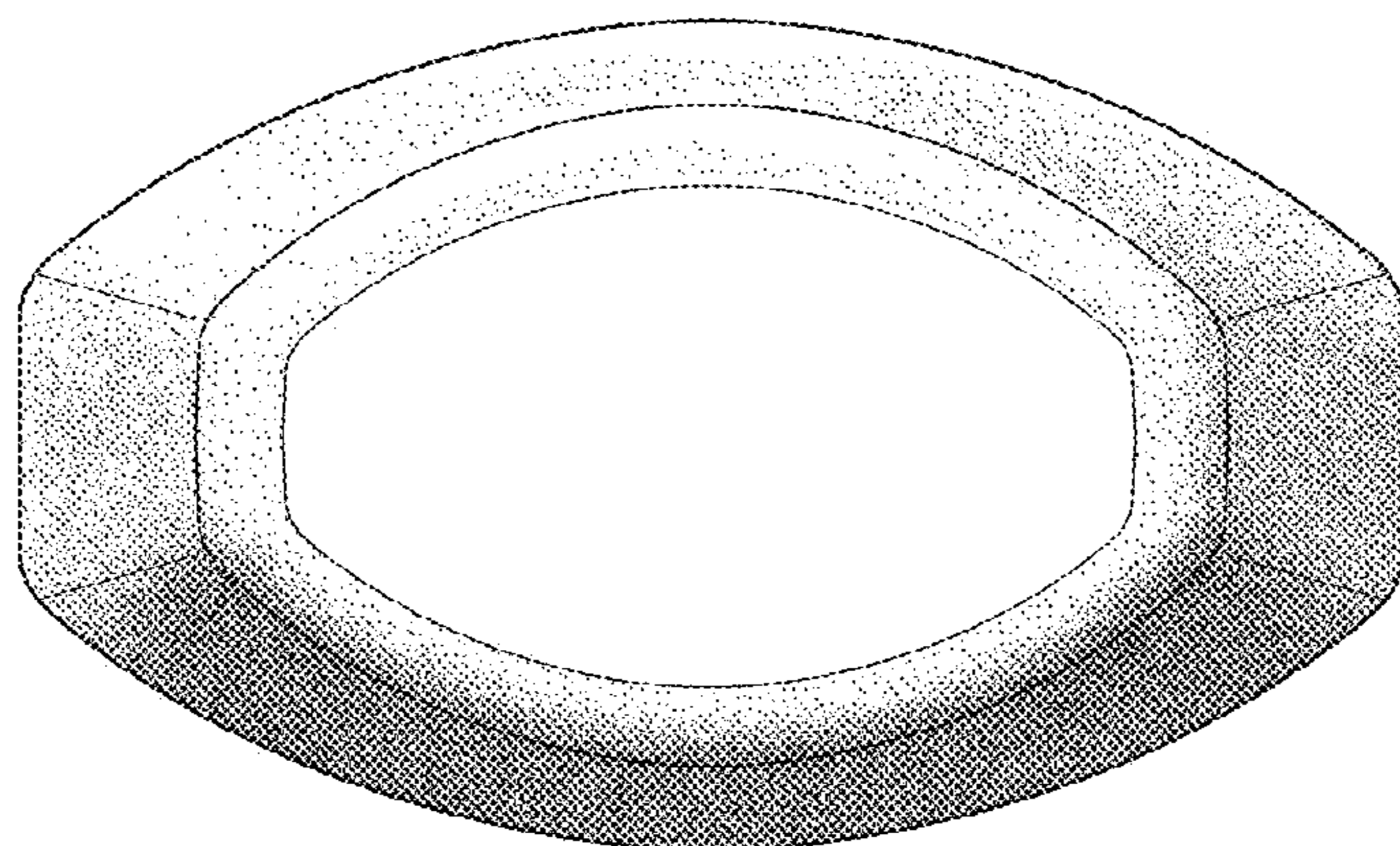

Fig. 14