



US00D748931S

(12) **United States Design Patent**  
**Corigliano**

(10) **Patent No.:** **US D748,931 S**

(45) **Date of Patent:** **\*\* Feb. 9, 2016**

- (54) **FOREARM CUSHION**
- (71) Applicant: **Ralph Corigliano**, Aurora, CO (US)
- (72) Inventor: **Ralph Corigliano**, Aurora, CO (US)
- (\*\*) Term: **14 Years**
- (21) Appl. No.: **29/506,185**
- (22) Filed: **Oct. 14, 2014**
- (51) **LOC (10) Cl.** ..... **06-09**
- (52) **U.S. Cl.**  
USPC ..... **D6/601**
- (58) **Field of Classification Search**  
USPC ..... D6/595-601, 604; D21/803, 804;  
D24/183  
CPC ..... A47C 7/021; A47C 7/383; A47C 7/428;  
A47C 7/546; A47C 16/00; A47C 20/00;  
A47C 20/02; A47C 20/021; A47C 20/026;  
A47C 20/027; A47G 9/10; A47G 9/1027;  
A47G 9/1045; A47G 9/1054; A47G 9/1063;  
A47G 9/1072; A47G 9/1081; A47G 9/109;  
A47D 13/00; A47D 13/08  
See application file for complete search history.

- 4,071,031 A \* 1/1978 Lowman ..... A61F 7/0085  
128/DIG. 20
- D330,978 S \* 11/1992 Vasquez ..... 297/183.8
- 6,065,166 A \* 5/2000 Sharrock ..... A61G 7/065  
5/636
- D471,050 S \* 3/2003 Haubner ..... D6/601
- D489,561 S \* 5/2004 Corbett ..... D6/596
- D494,404 S \* 8/2004 Corbett ..... D6/596
- D557,464 S \* 12/2007 Novak ..... D30/160
- D713,165 S \* 9/2014 Robinson ..... D6/391
- D718,456 S \* 11/2014 McNamee ..... D24/171
- 2004/0139548 A1 \* 7/2004 Hwang-Pao ..... A47G 9/1009  
5/636
- 2006/0055215 A1 \* 3/2006 Potosky ..... A47D 13/083  
297/219.1

\* cited by examiner

*Primary Examiner* — Mary Ann Calabrese  
(74) *Attorney, Agent, or Firm* — Rod D. Baker

(57) **CLAIM**  
I claim the ornamental design for a forearm cushion, as shown and described.

**DESCRIPTION**

FIG. 1 is a perspective view of the forearm cushion showing my ornamental design;  
FIG. 2 is a front elevation view thereof;  
FIG. 3 is a rear elevation view thereof;  
FIG. 4 is a right side elevation view thereof;  
FIG. 5 is a left side elevation view thereof;  
FIG. 6 is a top plan view thereof; and,  
FIG. 7 is a bottom plan view thereof.

**1 Claim, 5 Drawing Sheets**

- (56) **References Cited**  
U.S. PATENT DOCUMENTS  
1,836,604 A \* 12/1931 Meyer ..... C13B 50/02  
127/30  
3,946,451 A \* 3/1976 Spann ..... A61G 7/0755  
5/650

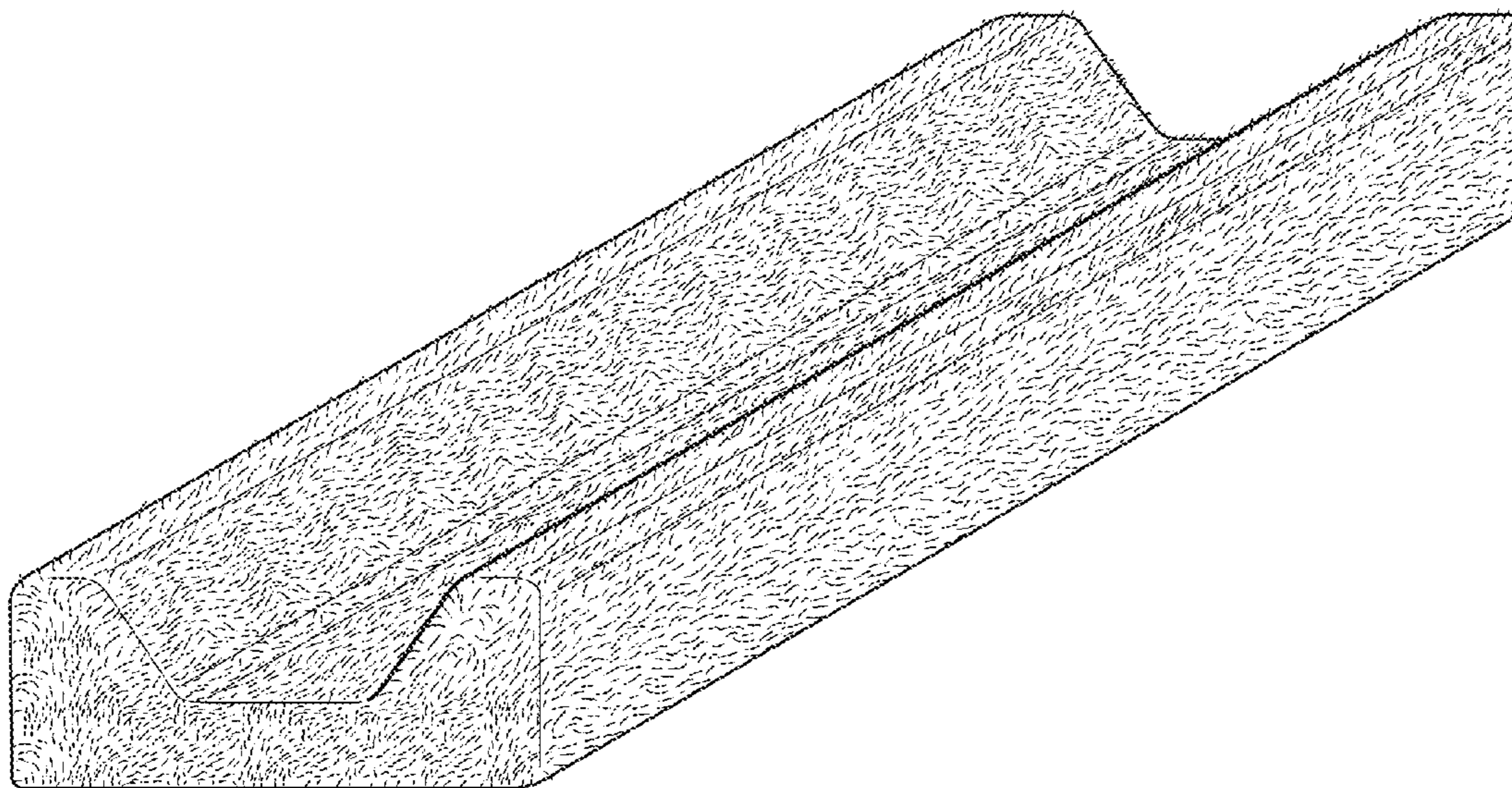

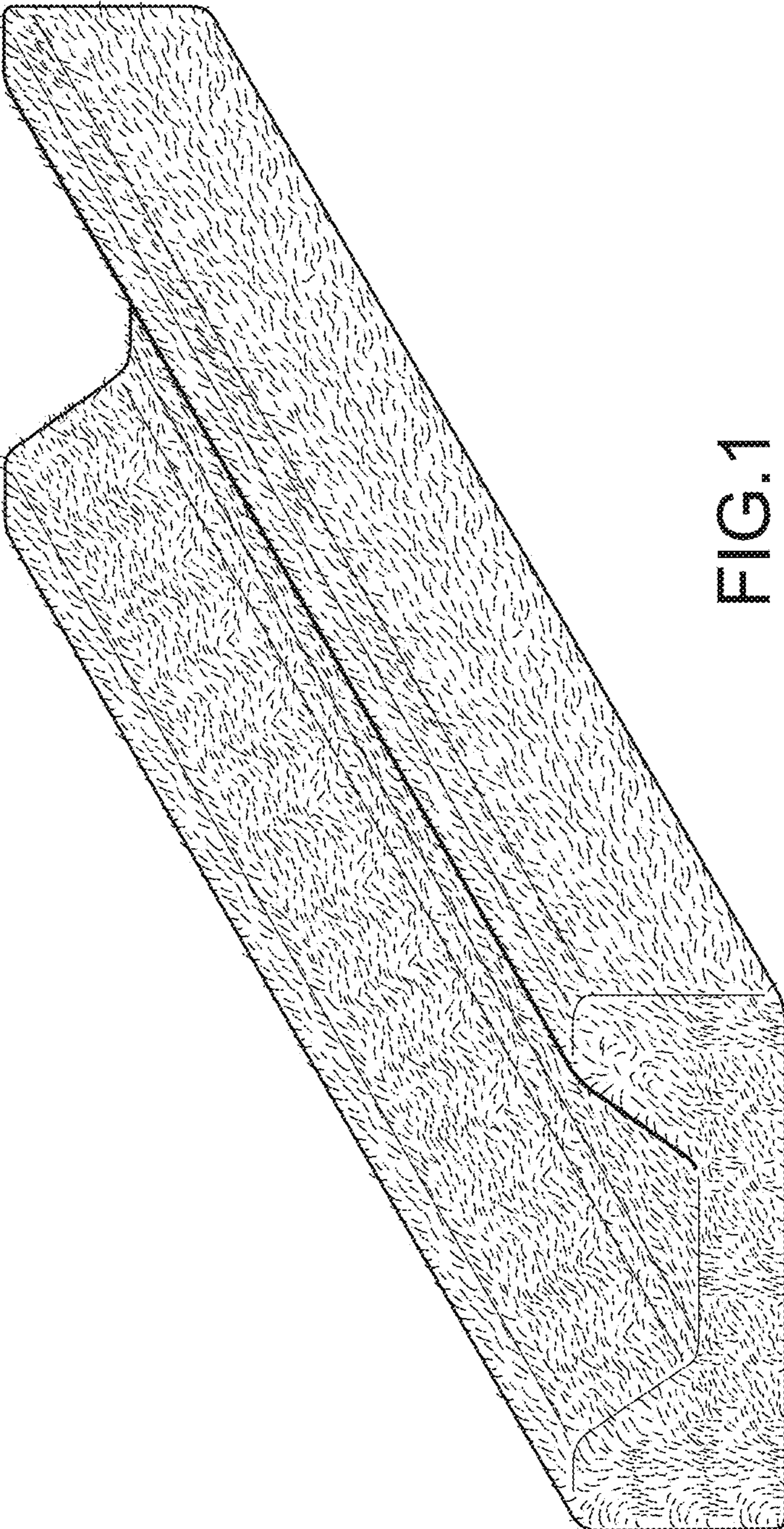

FIG. 1

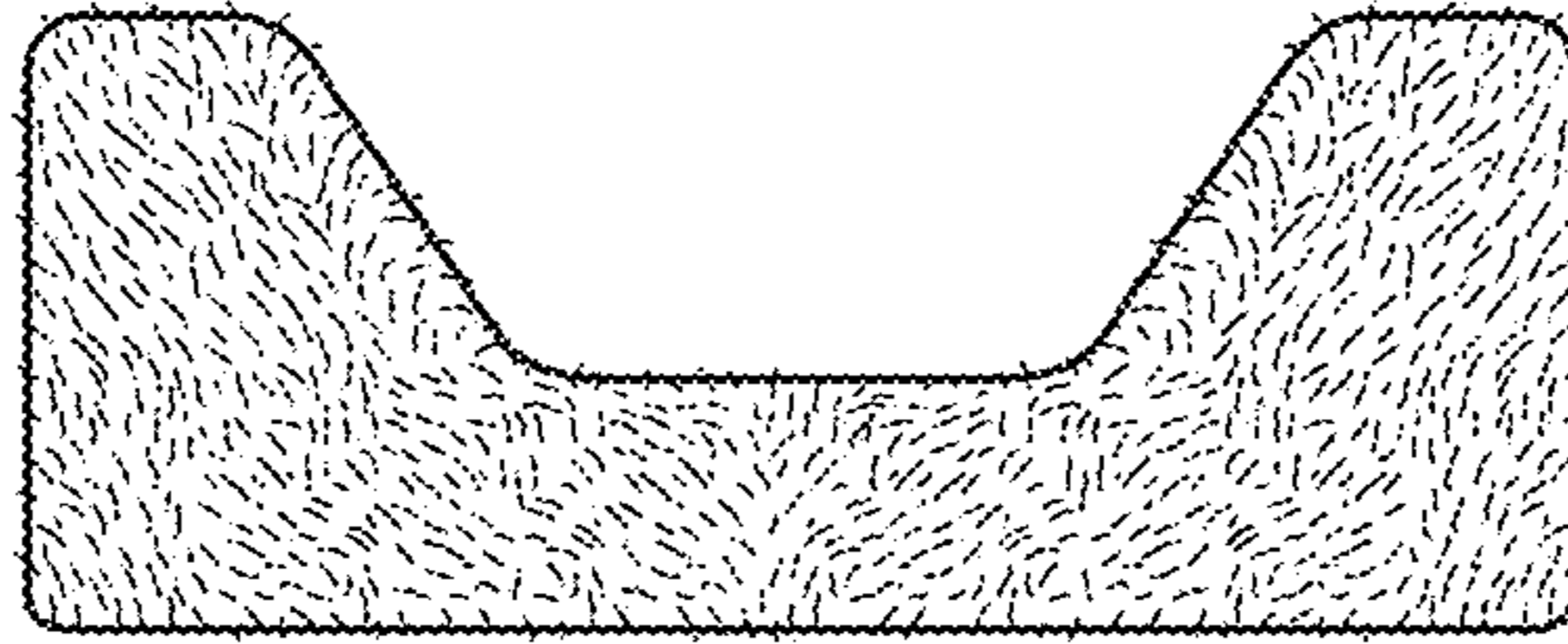

FIG. 2

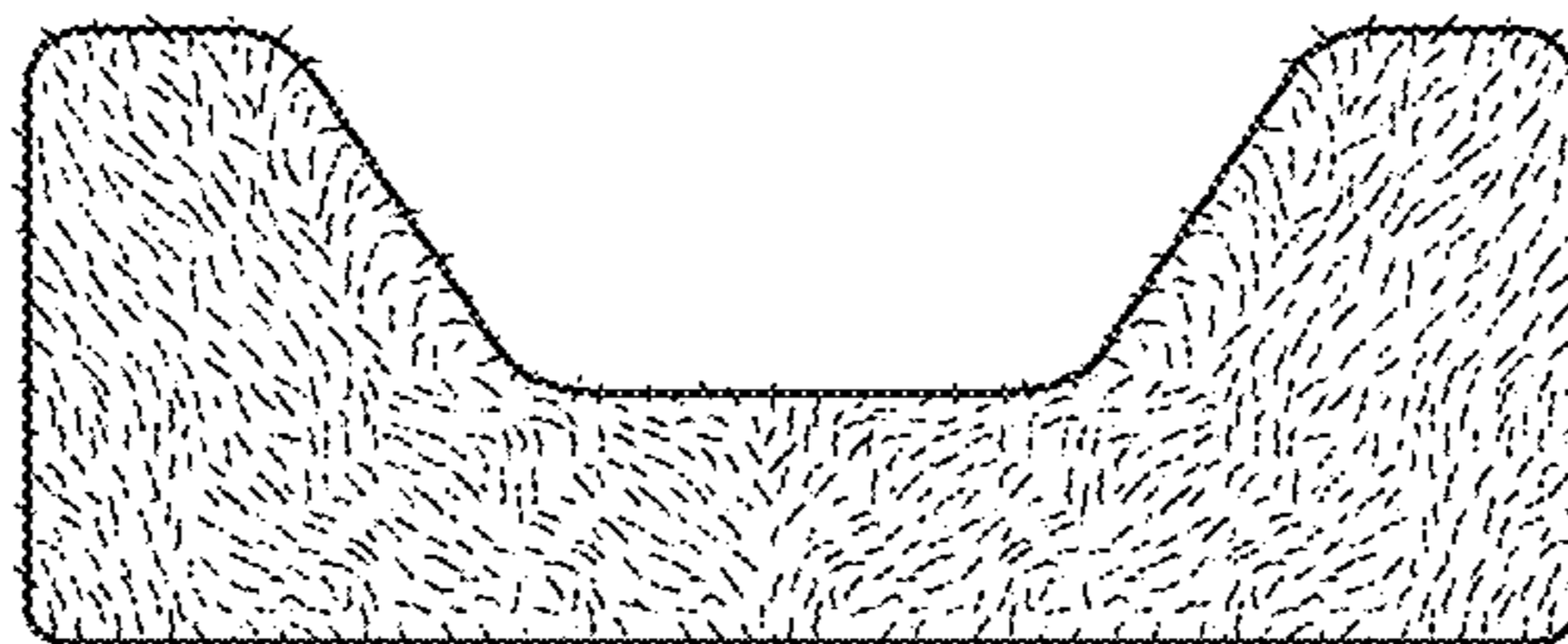

FIG. 3

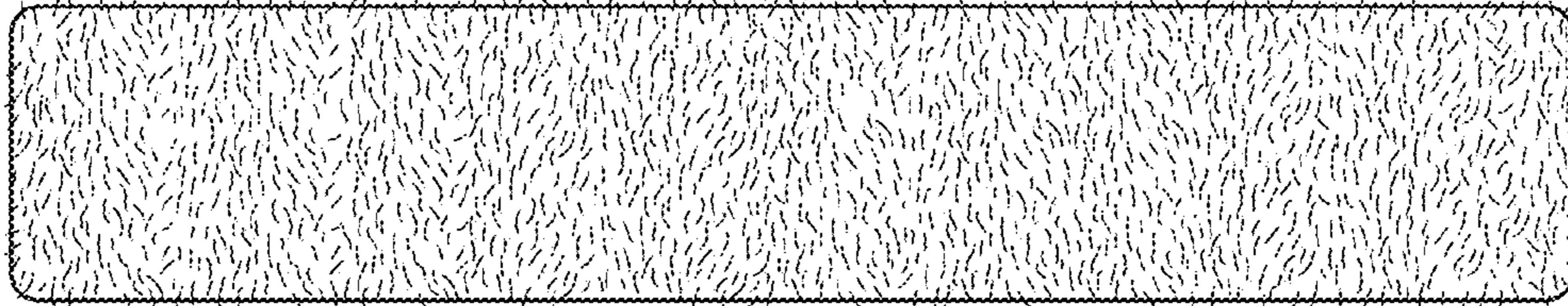

FIG. 4

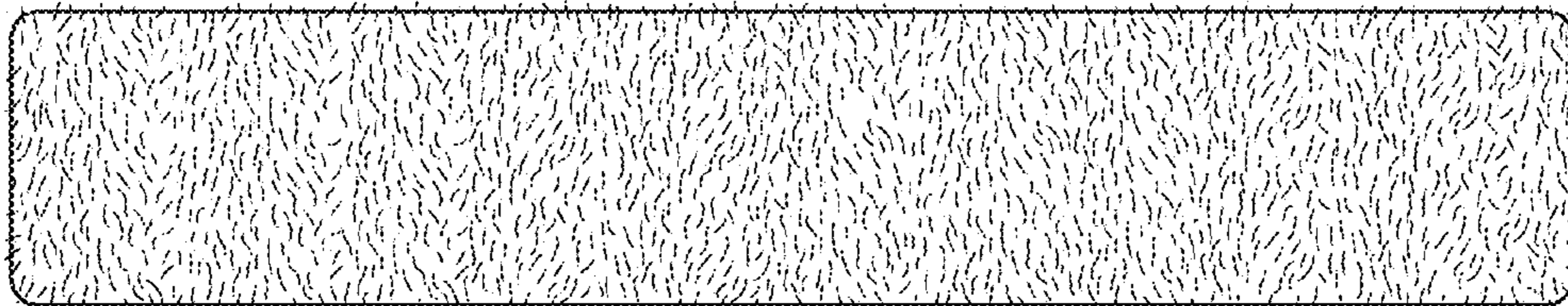

FIG. 5

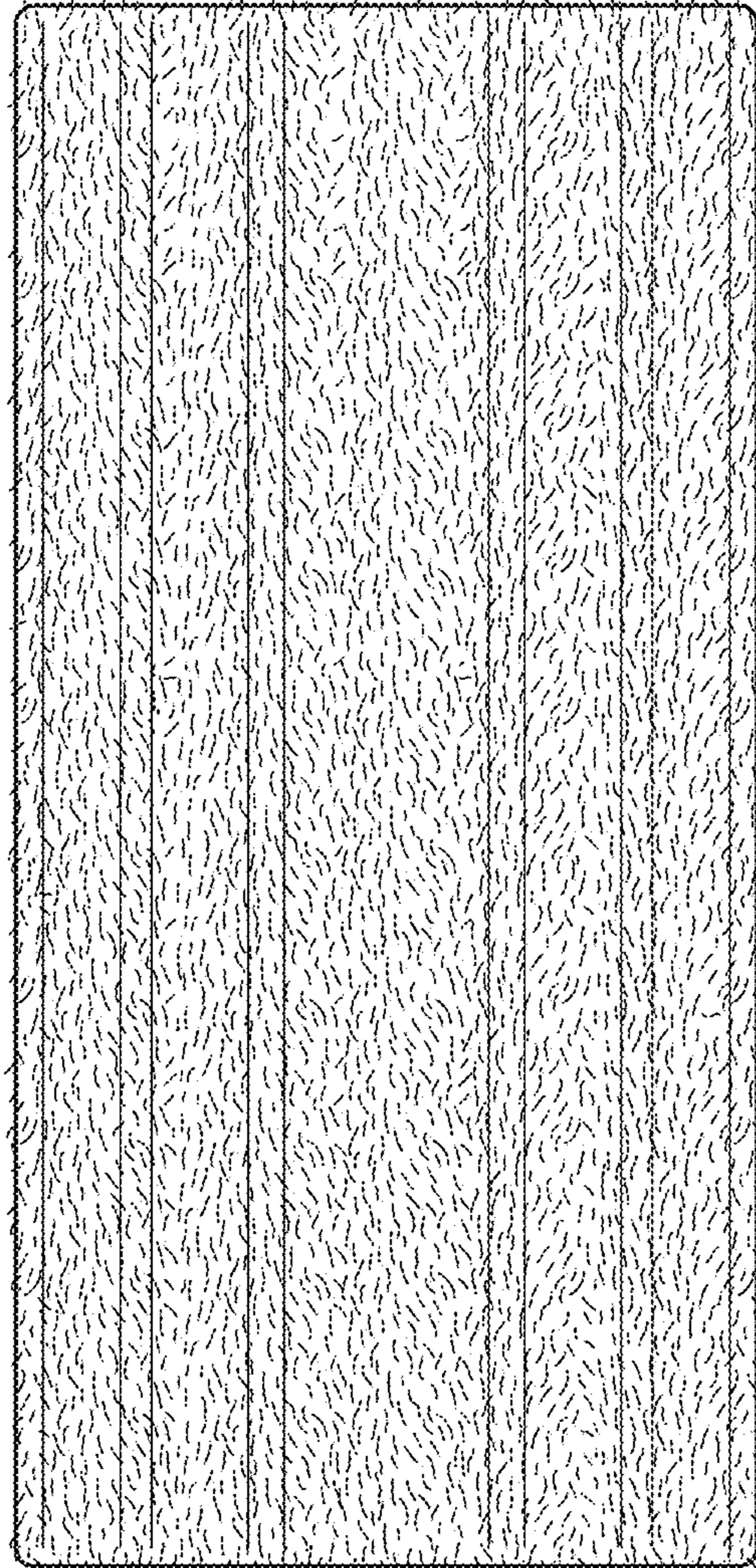

FIG.6

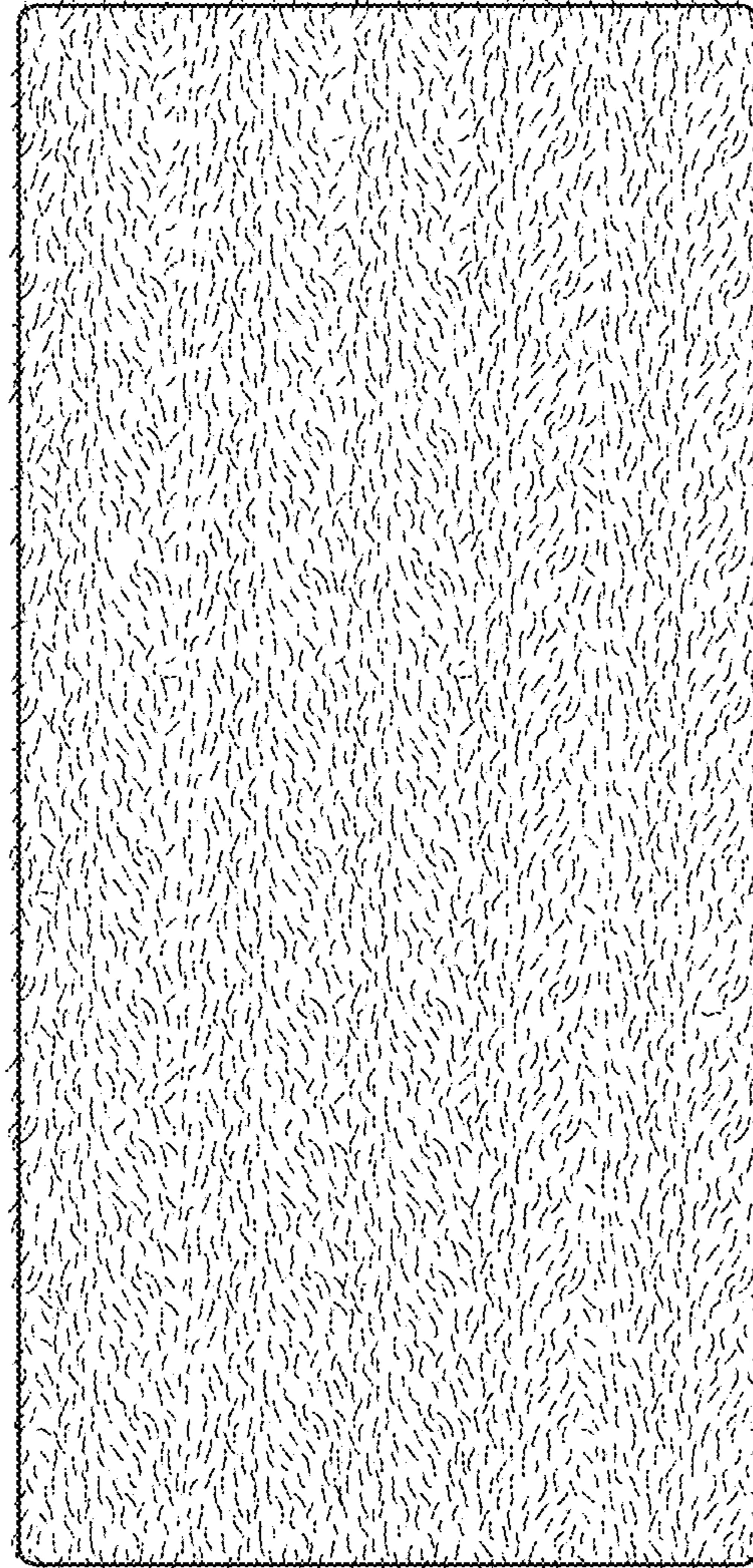

FIG.7