



US00D748913S

(12) **United States Design Patent**
Orietti Carella

(10) **Patent No.:** **US D748,913 S**
(45) **Date of Patent:** **** Feb. 9, 2016**

- (54) **BAG**
- (71) Applicant: **Mauro Maria Orietti Carella**, Milan (IT)
- (72) Inventor: **Mauro Maria Orietti Carella**, Milan (IT)
- (**) Term: **14 Years**
- (21) Appl. No.: **29/506,517**
- (22) Filed: **Oct. 16, 2014**
- (30) **Foreign Application Priority Data**
 - Apr. 16, 2014 (IT) 002448472-0001
 - Apr. 16, 2014 (IT) 002448472-0002
- (51) **LOC (10) Cl.** **03-01**
- (52) **U.S. Cl.**
 - USPC **D3/245**
- (58) **Field of Classification Search**
 - USPC D3/232-233, 240-243, 245-246
 - CPC A45C 1/024; A45C 3/06
 - See application file for complete search history.

3,262,478 A * 7/1966 Amsterdam 150/112
 3,669,169 A * 6/1972 Lubliner 150/107
 D557,892 S * 12/2007 Greiner D3/205

* cited by examiner

Primary Examiner — Holly Baynham
(74) *Attorney, Agent, or Firm* — LeClairRyan, a Professional Corporation

(57) **CLAIM**
The ornamental design for a bag, as shown and described.

DESCRIPTION

FIG. 1 is a front view of an embodiment of a bag with a handle;
 FIG. 2 is a back view of the bag shown in FIG. 1;
 FIG. 3 is a right side view of the bag shown in FIG. 1, the left side view is a mirror image of the right side view and thus is not shown;
 FIG. 4 is a bottom view of the bag shown in FIG. 1;
 FIG. 5 is a right perspective view of the bag shown in FIG. 1 in a closed arrangement;
 FIG. 6 is a left perspective view of the bag shown in FIG. 1 in an open arrangement;
 FIG. 7 is a right side view of another embodiment of the bag without a handle, the left side view is a mirror image of the right side view thus is not shown; and,
 FIG. 8 is a front view of the another embodiment of the bag without the handle shown in FIG. 7 and the other views of this embodiment of the bag are the same as illustrated in FIGS. 1-6 except there is no handle in this embodiment.

1 Claim, 8 Drawing Sheets

- (56) **References Cited**
 - U.S. PATENT DOCUMENTS**
 - 2,487,090 A * 11/1949 Bamberger 150/117
 - 2,814,323 A * 11/1957 Brill 150/115

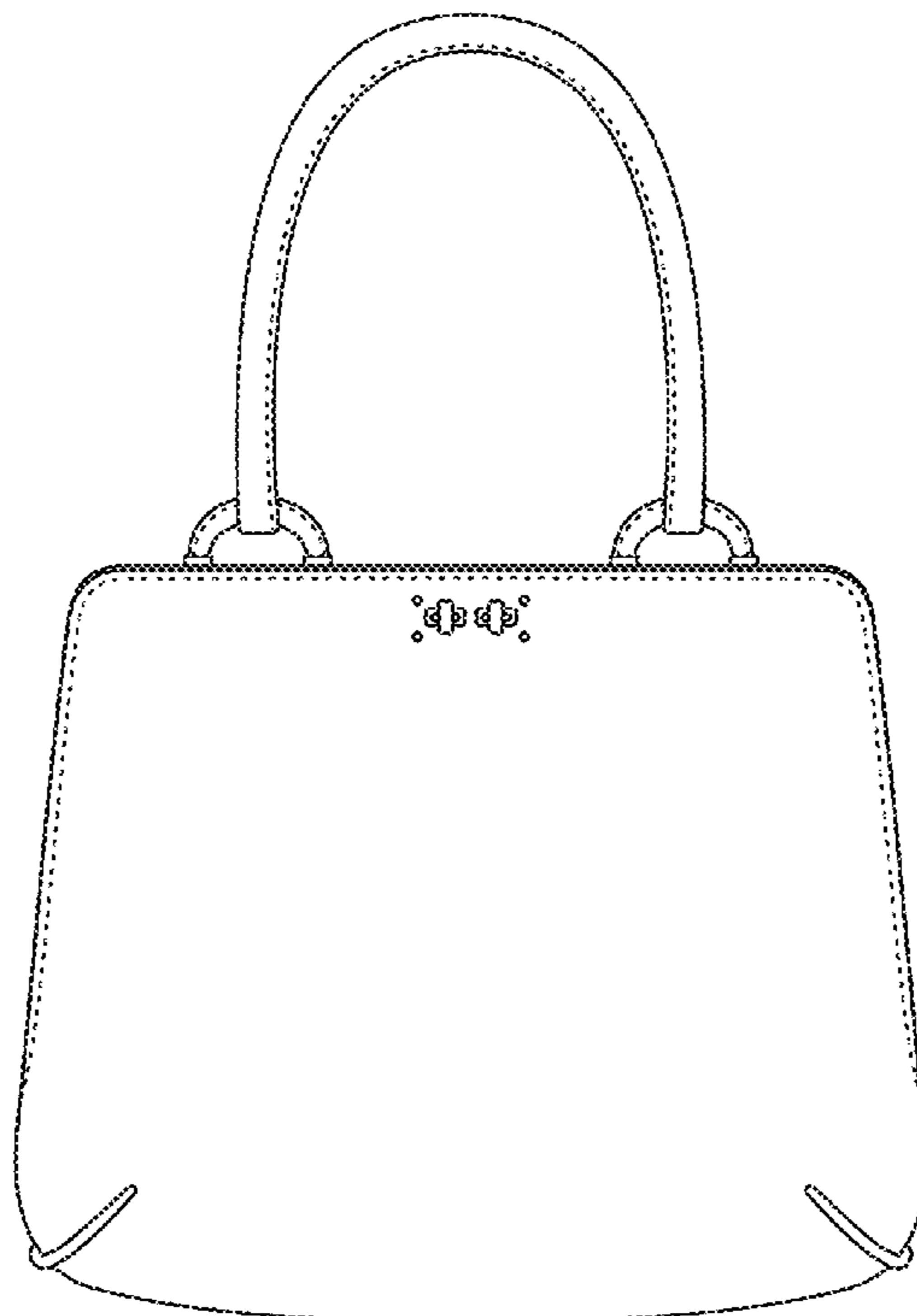



Fig. 1

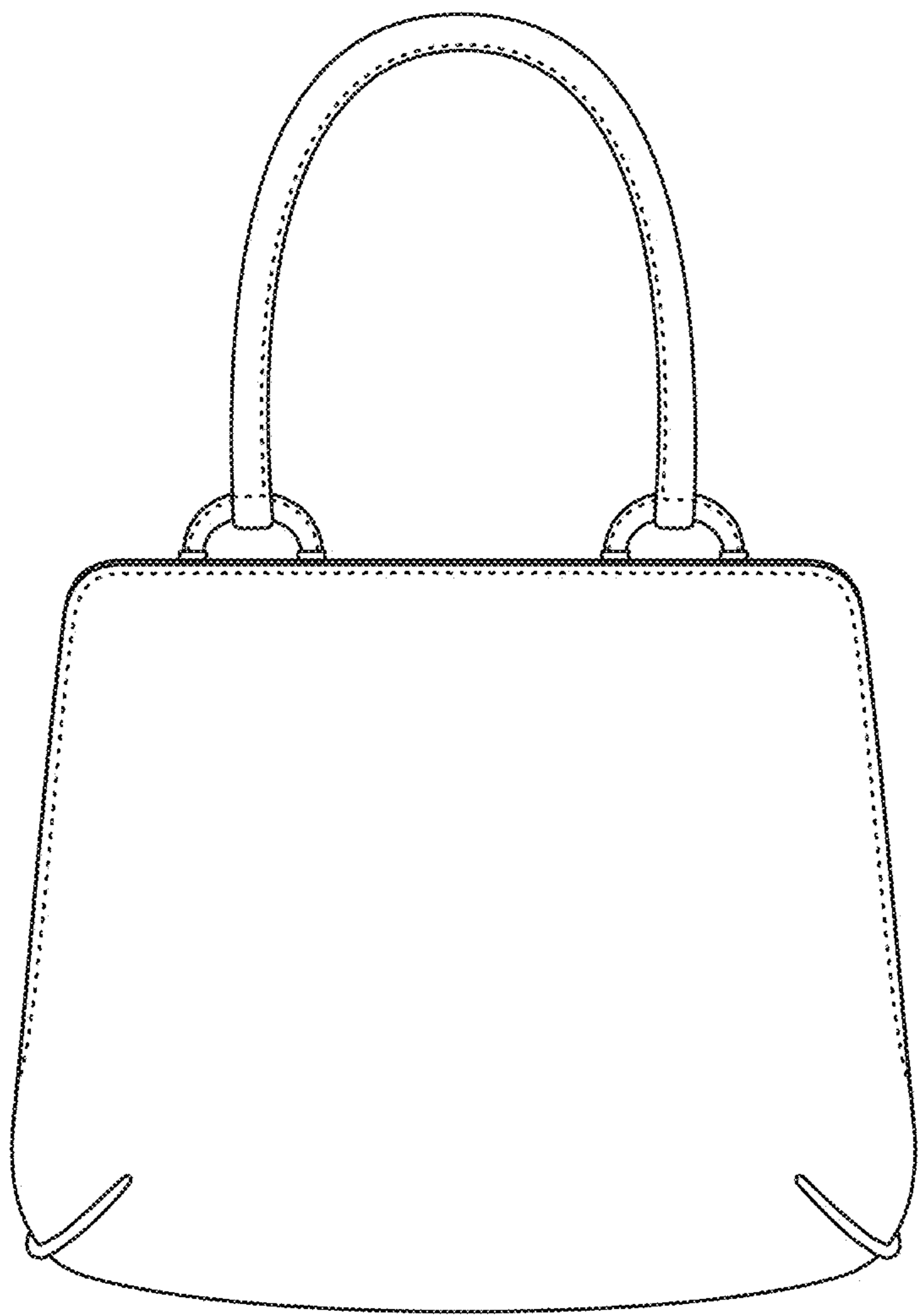

Fig. 2

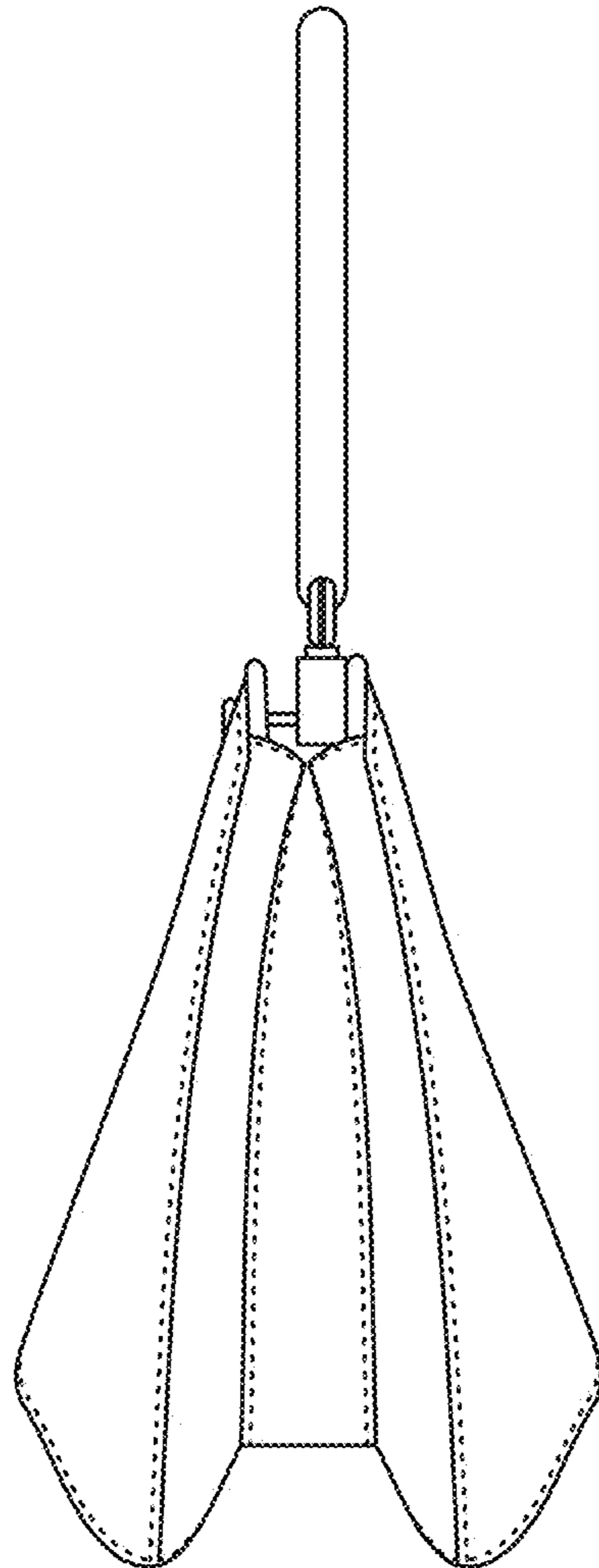

Fig. 3

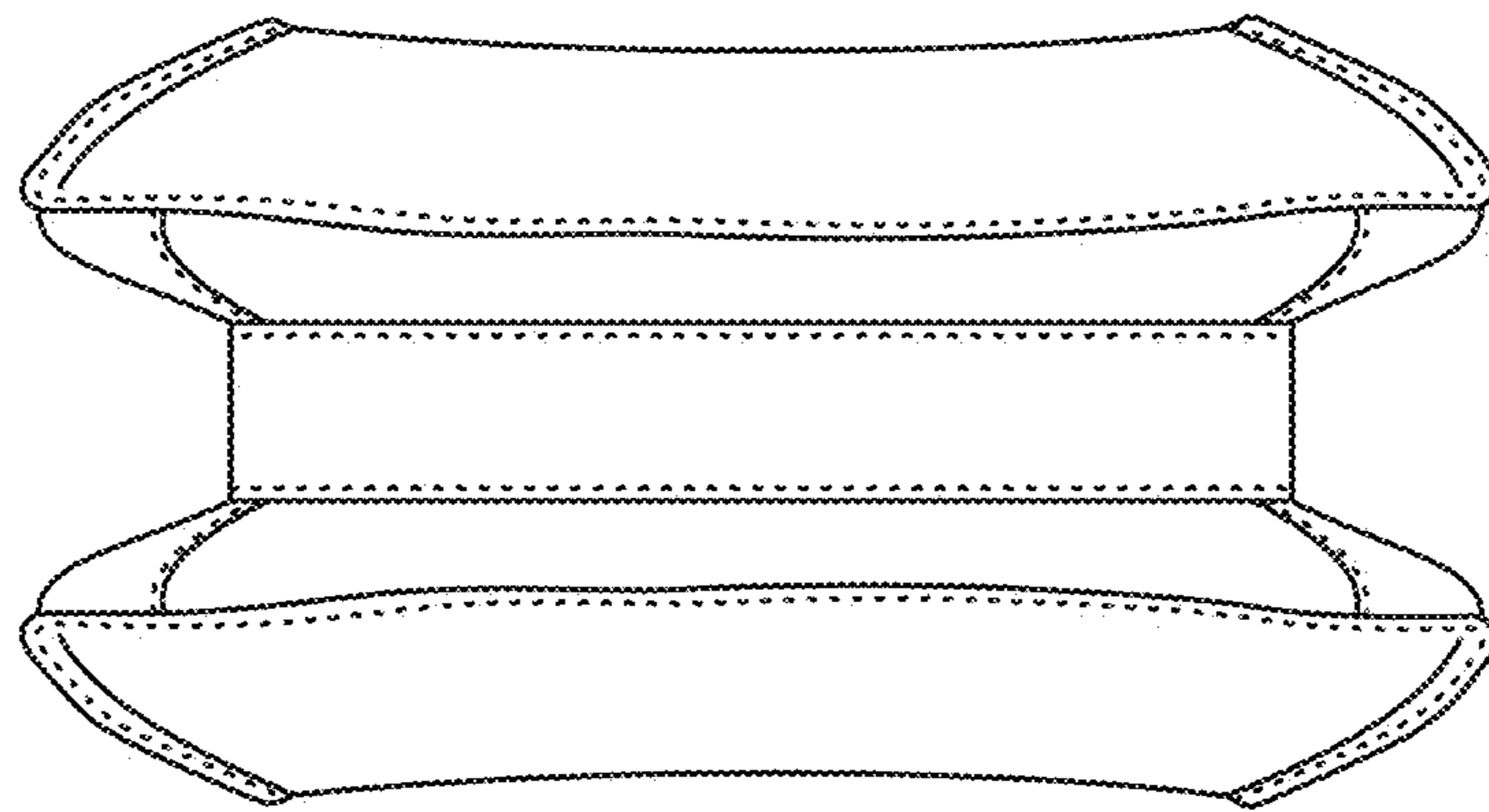

Fig. 4

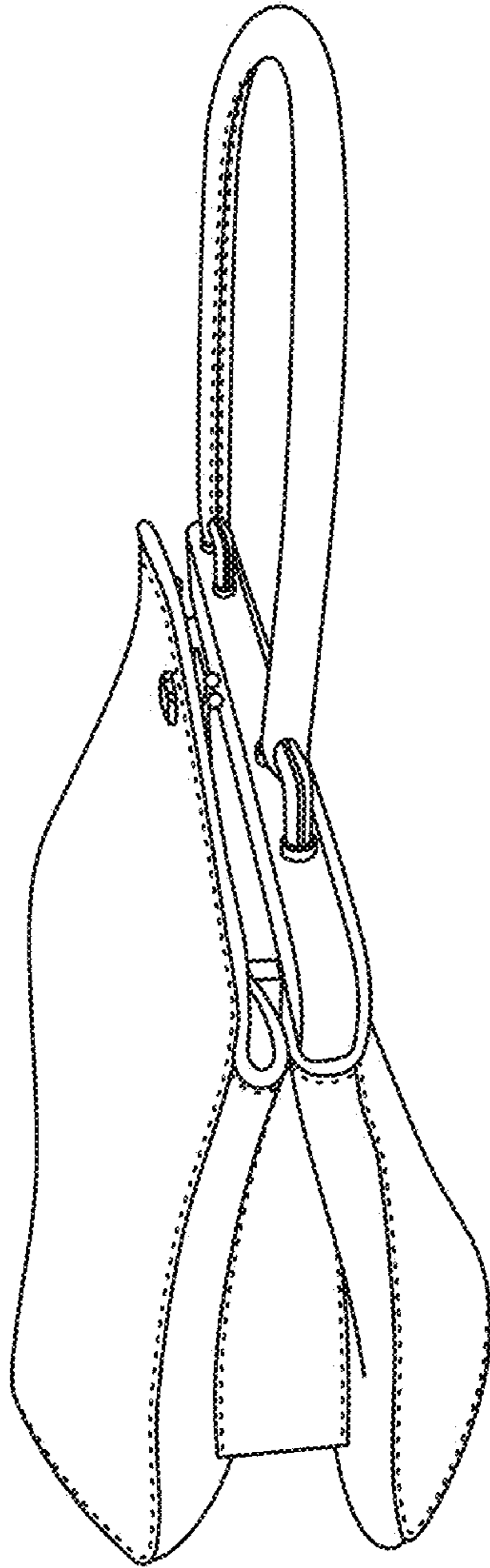

Fig. 5

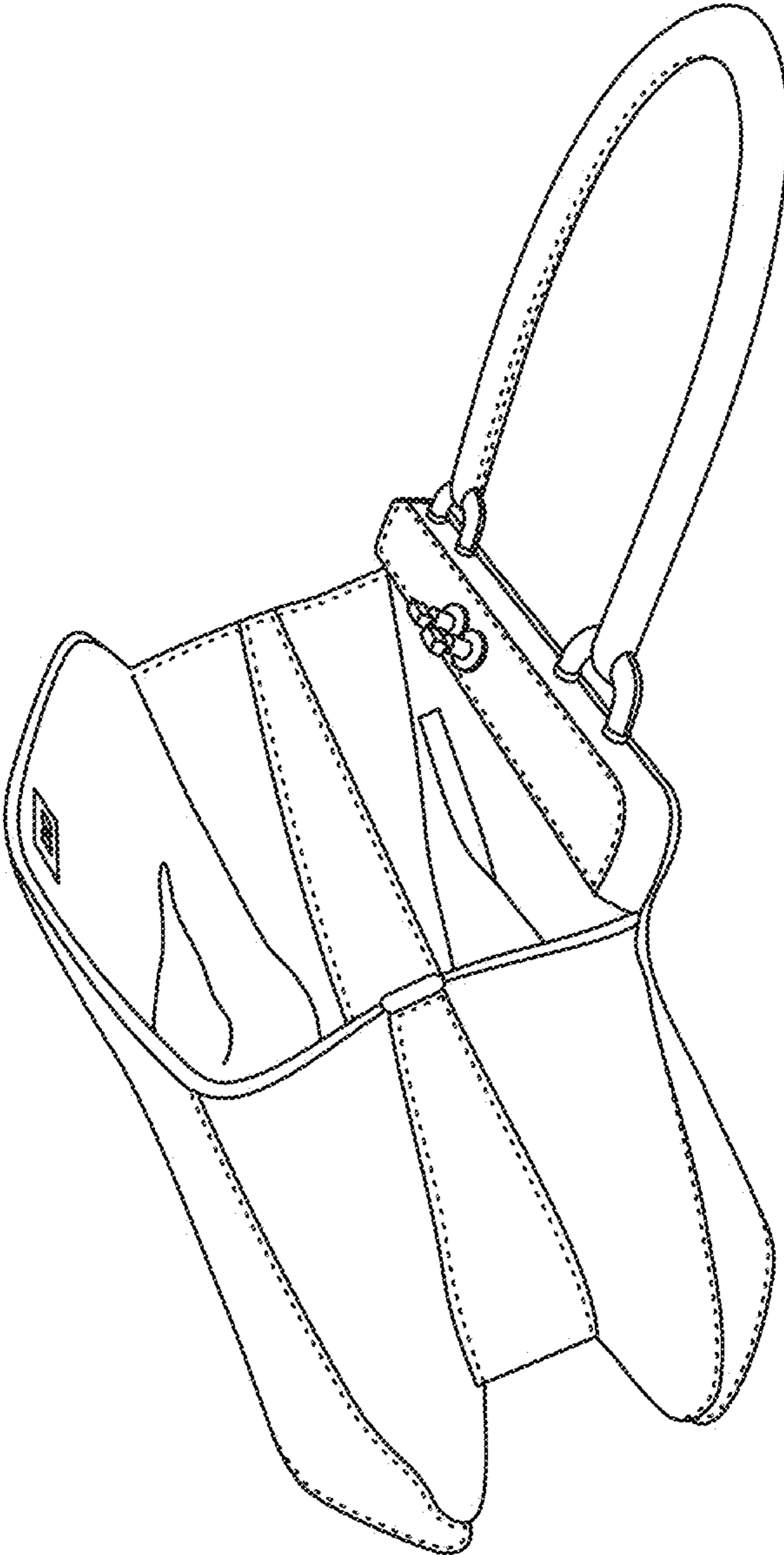

Fig. 6

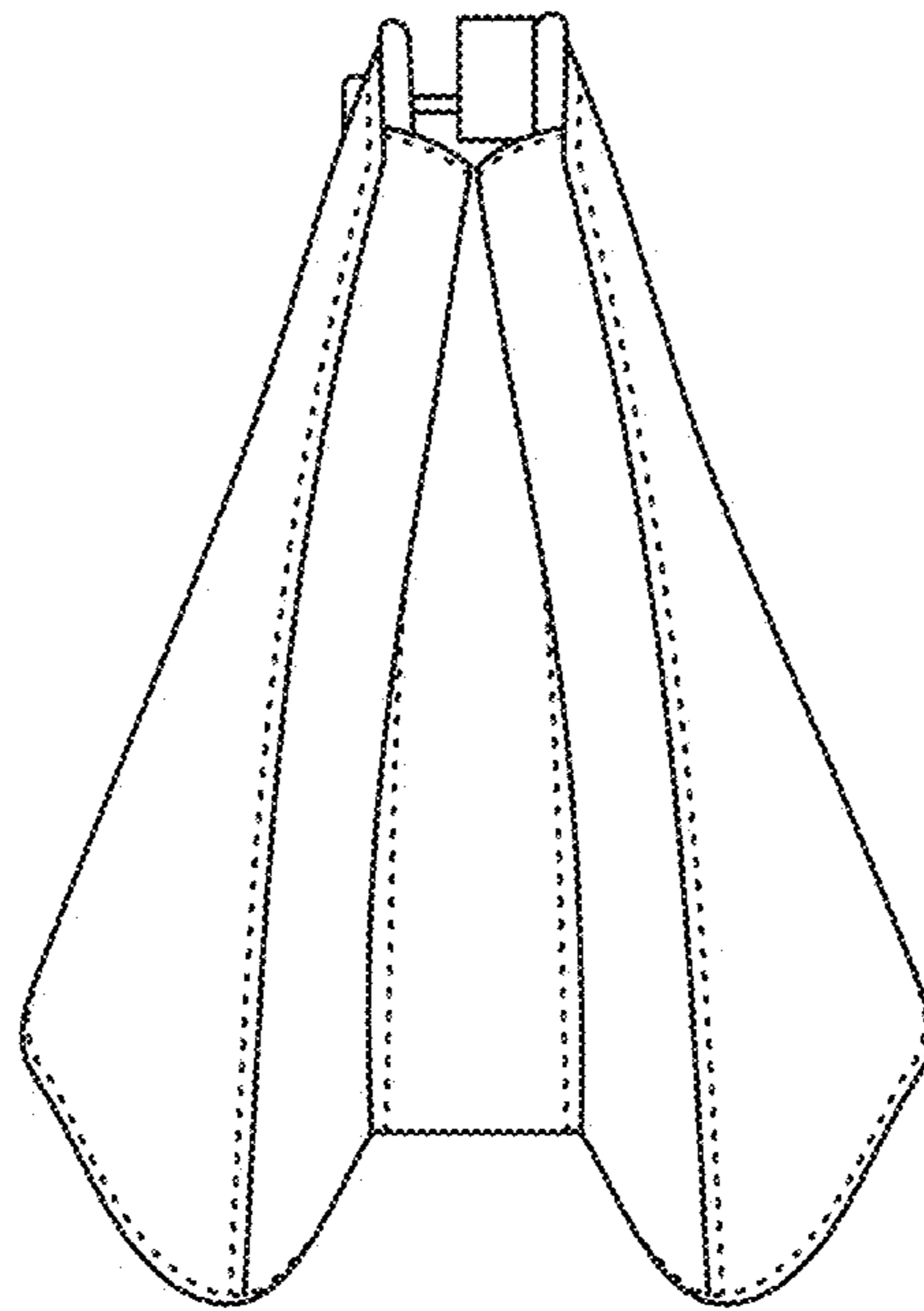

Fig. 7

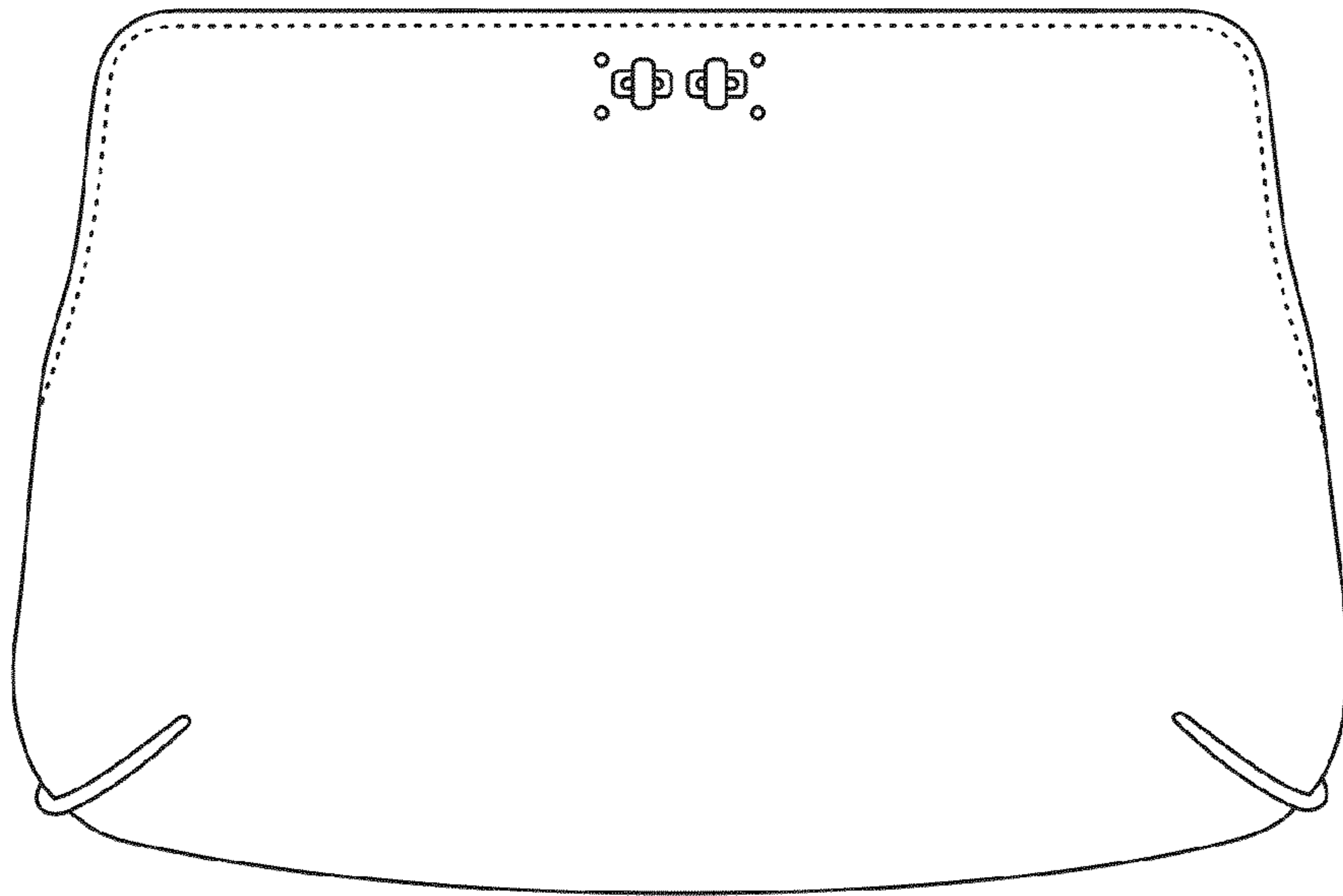

Fig. 8