



US00D748910S

(12) **United States Design Patent**  
**Ford et al.**

(10) **Patent No.:** **US D748,910 S**  
(45) **Date of Patent:** **\*\* Feb. 9, 2016**

- (54) **BACKPACK**
- (71) Applicant: **NIKE, Inc.**, Beaverton, OR (US)
- (72) Inventors: **Timothy John Ford**, Portland, OR (US);  
**Hrag Nassanian**, Beaverton, OR (US)
- (73) Assignee: **NIKE, Inc.**, Beaverton, OR (US)
- (\*\*) Term: **14 Years**
- (21) Appl. No.: **29/515,428**
- (22) Filed: **Jan. 22, 2015**
- (51) **LOC (10) Cl.** ..... **03-01**
- (52) **U.S. Cl.**  
USPC ..... **D3/217**
- (58) **Field of Classification Search**  
USPC ..... D3/201, 213–218, 231, 232, 267, 273,  
D3/289, 290, 318, 321, 327  
CPC ..... A45F 3/04; A45F 4/02; A45F 3/02;  
A45F 3/08; A45F 3/047; A45C 9/00; A45C  
5/14; A45C 13/02; A45C 3/00; A45C 13/08;  
A41D 15/04  
See application file for complete search history.

D699,943 S	2/2014	Mather	
D699,944 S	2/2014	Mather	
D706,534 S	6/2014	Zwetzig	
D708,845 S	7/2014	Taylor	
D731,181 S *	6/2015	Majeau et al.	..... D3/279
2007/0074941 A1*	4/2007	Liang	..... 190/107

**OTHER PUBLICATIONS**

Nike Equipment Catalog, 2010 Holiday Equipment, p. 6, published Feb. 2010, NIKE, Inc., USA.  
 Nike Equipment Catalog, 2010 Spring Accessories and Equipment, p. 19, published May 2009, NIKE, Inc., USA.  
 Nike Equipment Catalog, 2010 Spring Basketball Equipment, p. 7, published May 2009, NIKE, Inc., USA.

\* cited by examiner

*Primary Examiner* — George D Kirschbaum  
*Assistant Examiner* — Jennifer Watkins  
 (74) *Attorney, Agent, or Firm* — Banner & Witcoff, Ltd.

(57) **CLAIM**  
 The ornamental design for a backpack, as shown and described.

**DESCRIPTION**

FIG. 1 is a top, front, right perspective view of a backpack showing our new design;  
 FIG. 2 is a top front, left perspective view thereof;  
 FIG. 3 is a front view thereof;  
 FIG. 4 is a left side view thereof;  
 FIG. 5 is a right side view thereof; and,  
 FIG. 6 is a top view thereof.  
 The even-length broken lines within the shaded area represent portions of the backpack that form no part of the claim. The uneven-length broken lines immediately adjacent to the shaded area represent boundary lines that form no part of the claim. The even-length broken lines showing the remainder of the backpack are for the purpose of illustrating environment that forms no part of the claimed design.

**1 Claim, 6 Drawing Sheets**

(56) **References Cited**  
**U.S. PATENT DOCUMENTS**

D409,376 S	5/1999	Golenz et al.	
D431,903 S	10/2000	Worley et al.	
D485,678 S	1/2004	Haro	
D485,987 S *	2/2004	Hassett	..... D3/267
D520,238 S *	5/2006	Montague	..... D3/290
D535,480 S *	1/2007	Fangman et al.	..... D3/321
D552,845 S	10/2007	Shor et al.	
D553,349 S	10/2007	Aliberti et al.	
D610,797 S	3/2010	Shor et al.	
D641,973 S	7/2011	Quehl	
D642,791 S	8/2011	Quehl	
D665,573 S *	8/2012	Crandall	..... D3/217
D673,364 S *	1/2013	Webster	..... D3/232
D699,941 S *	2/2014	Robert	..... D3/216
D699,942 S	2/2014	Mather	

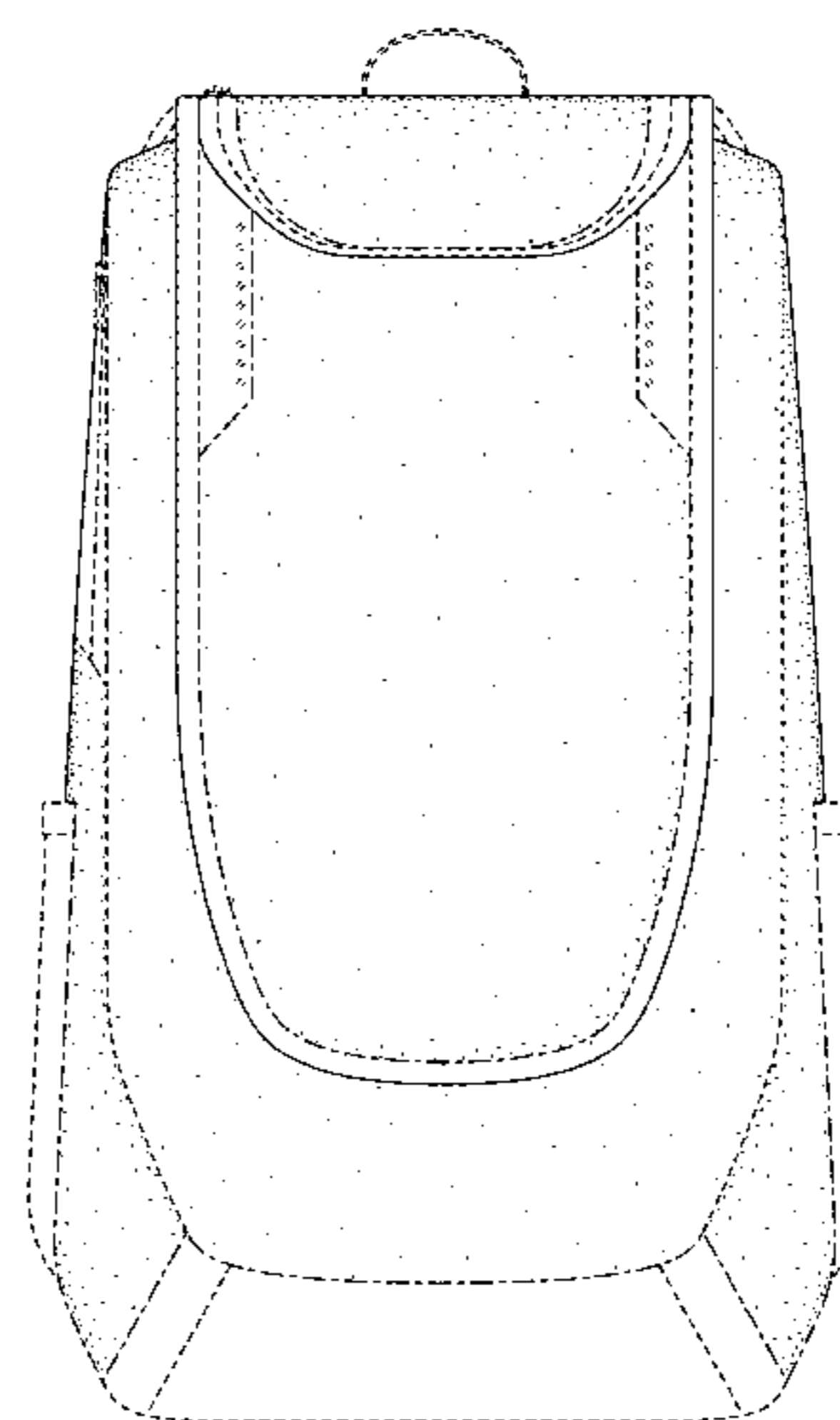
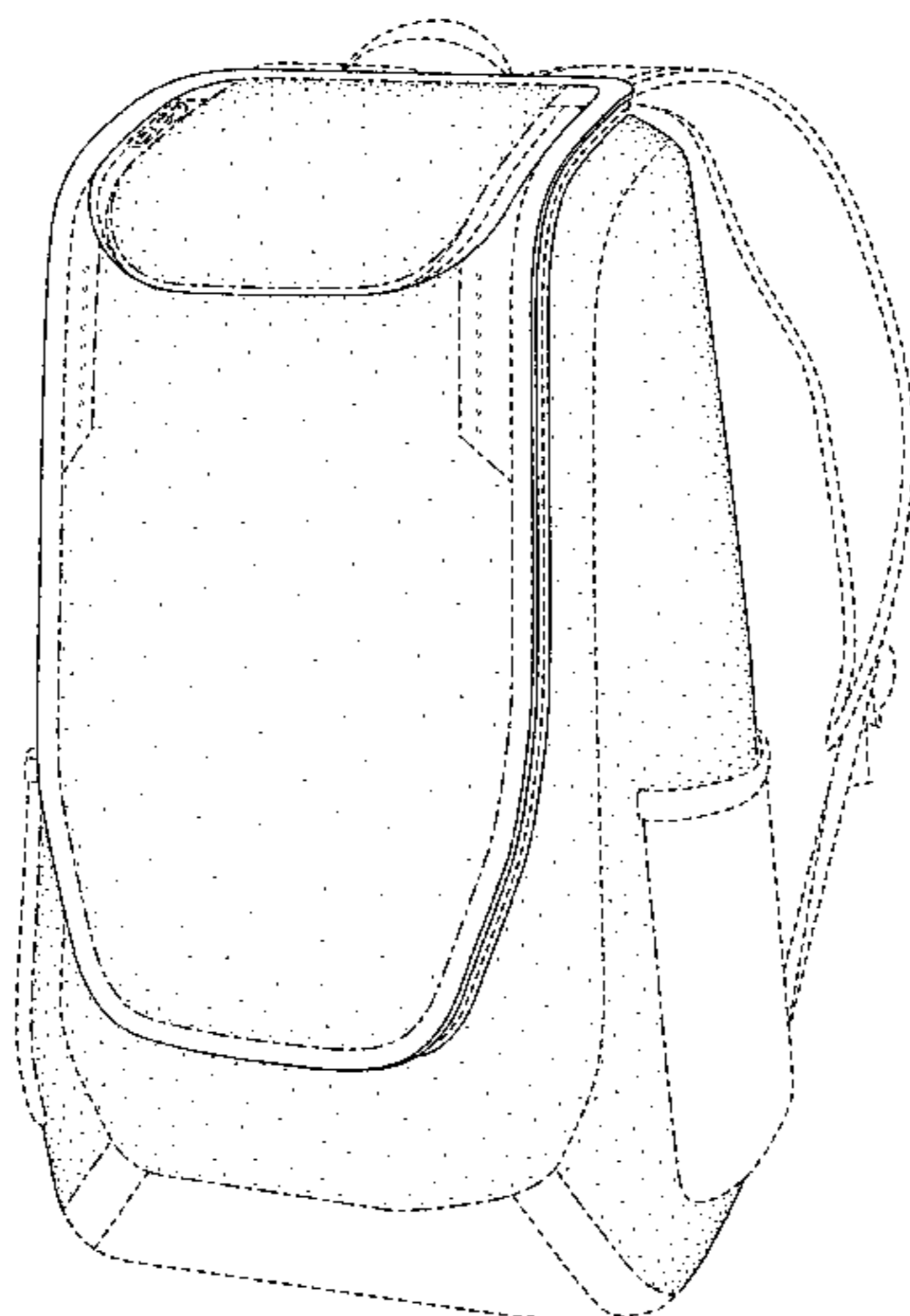

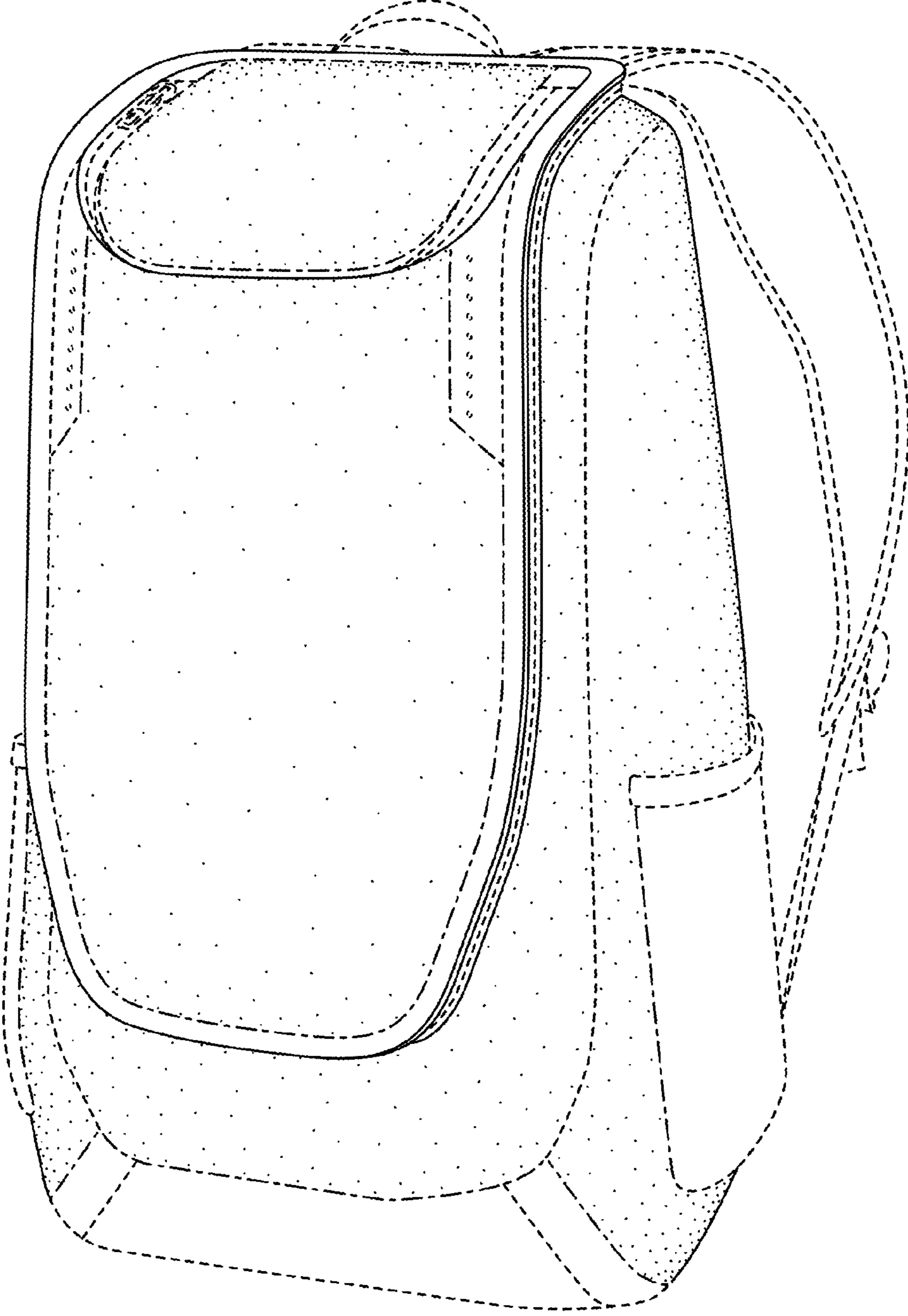

FIG. 1

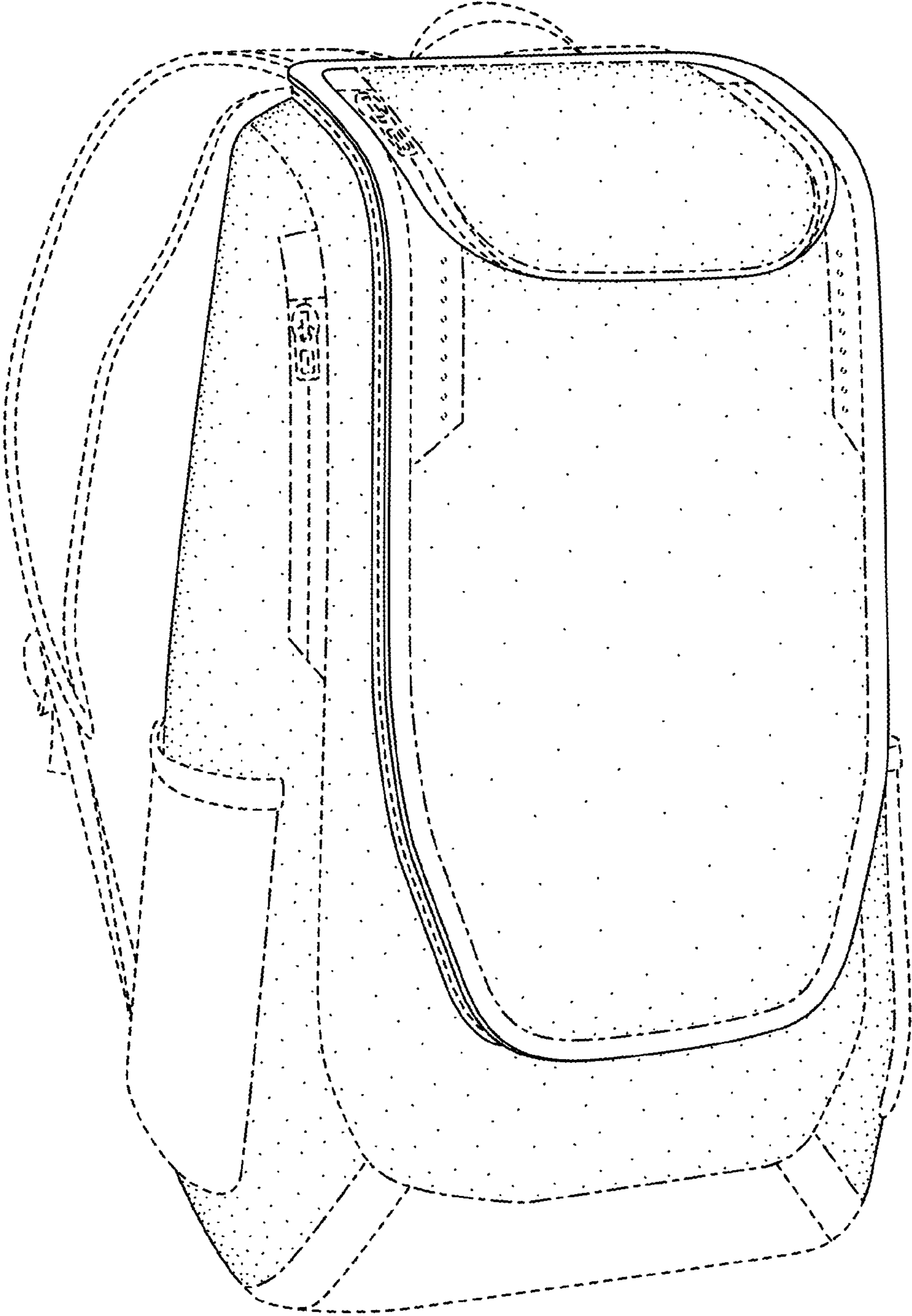

FIG. 2

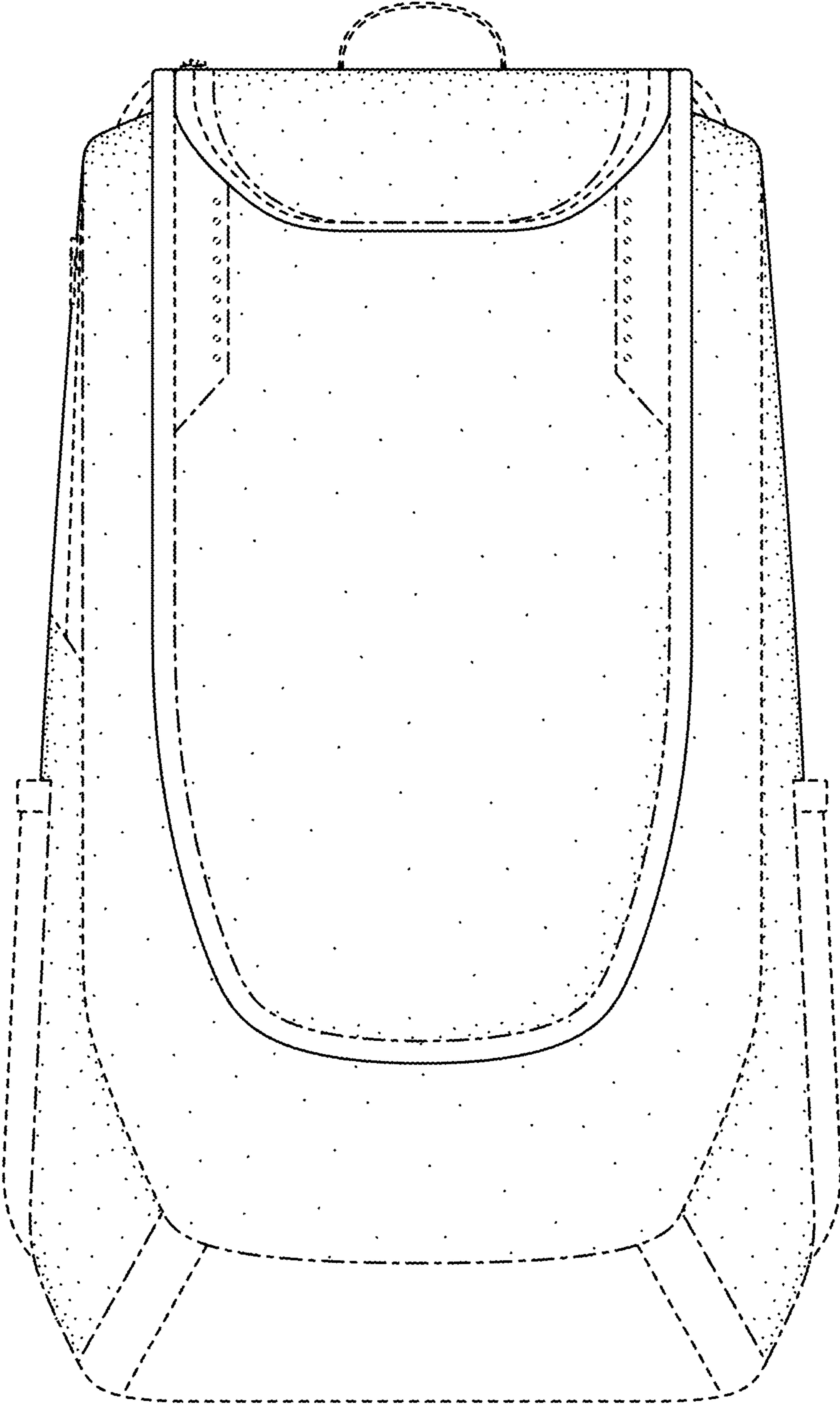

FIG. 3

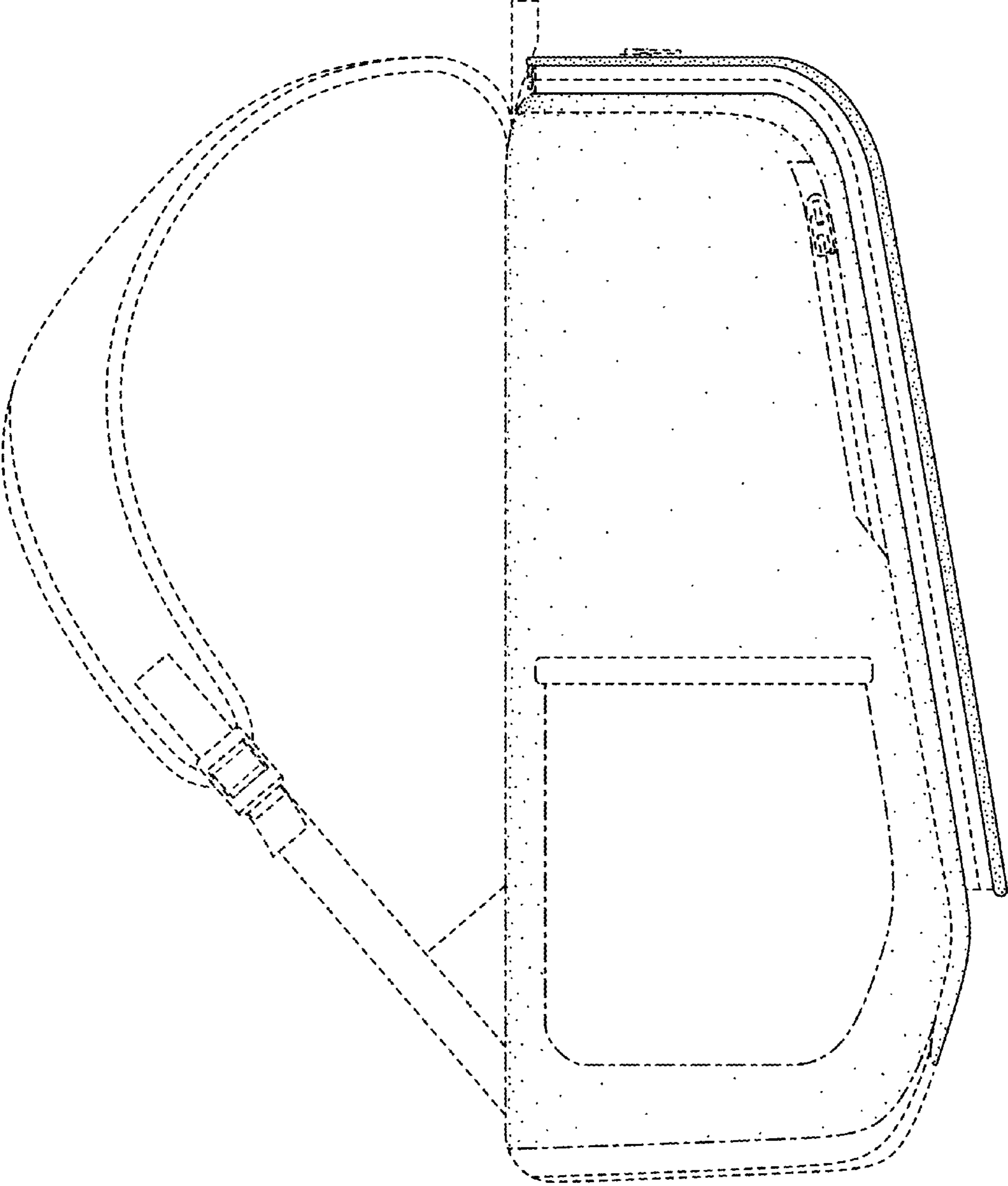

FIG. 4

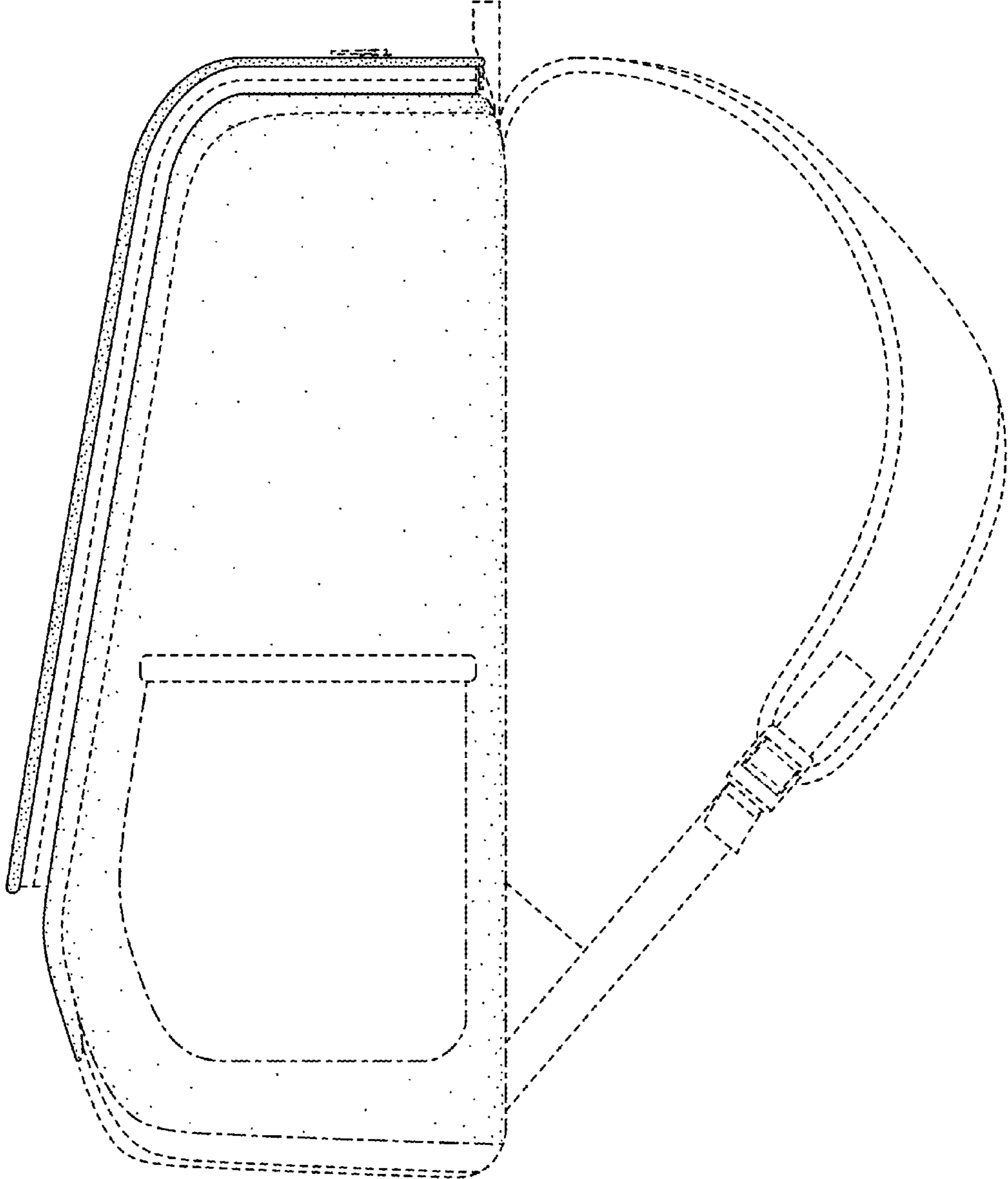

FIG. 5

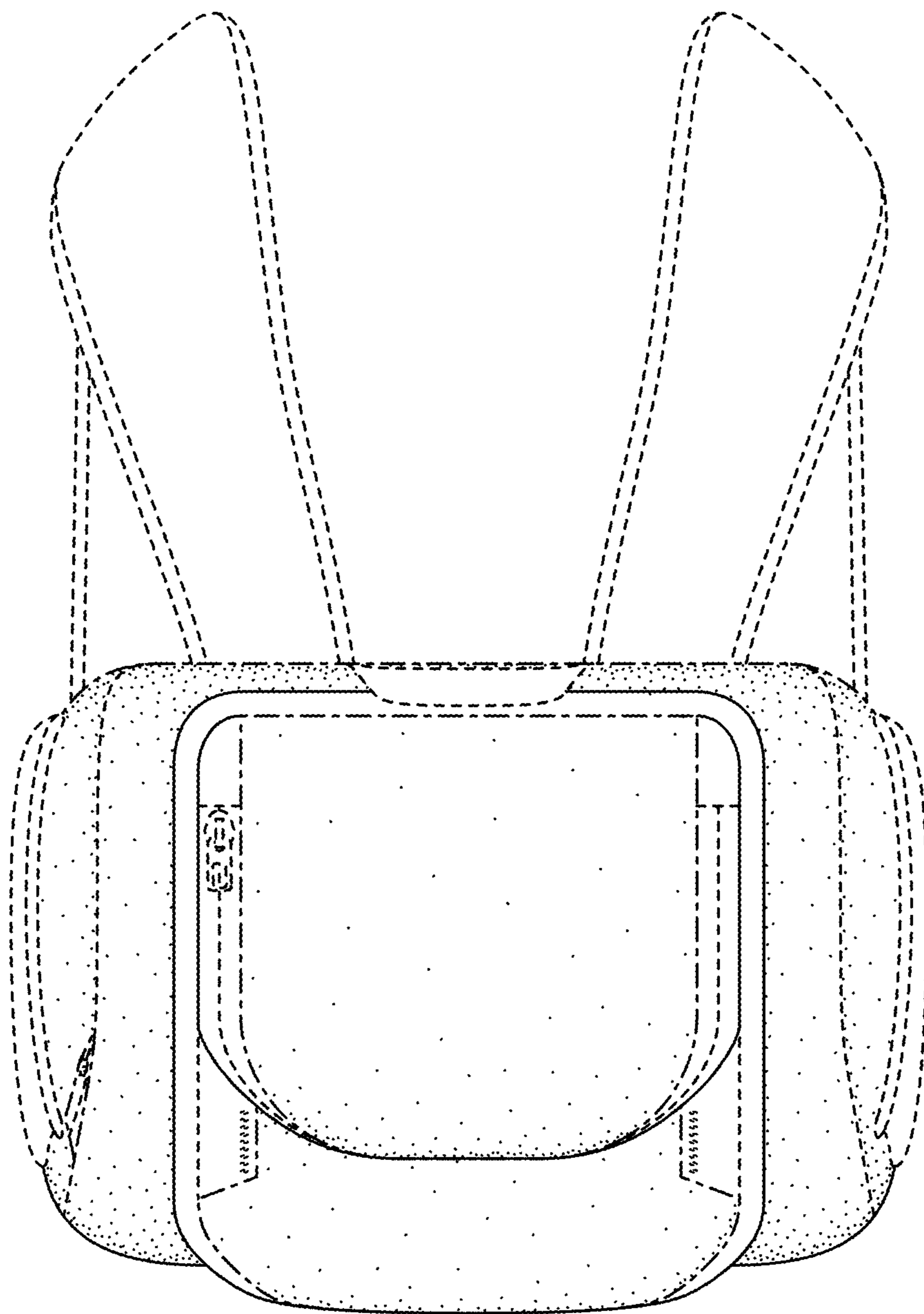

FIG. 6