



US00D748692S

(12) **United States Design Patent**
McConnell et al.

(10) **Patent No.:** **US D748,692 S**
(45) **Date of Patent:** **** Feb. 2, 2016**

(54) **APPLIANCE INTERIOR WITH COLOR**

(71) Applicant: **Whirlpool Corporation**, Benton Harbor, MI (US)

(72) Inventors: **Jessica R. McConnell**, St. Joseph, MI (US); **Daniel Henry Quinlan**, Stevensville, MI (US); **Kelly E. Roche**, St. Joseph, MI (US); **Michael S. Seeley**, South Haven, MI (US)

(73) Assignee: **Whirlpool Corporation**, Benton Harbor, MI (US)

(**) Term: **14 Years**

(21) Appl. No.: **29/485,364**

(22) Filed: **Mar. 18, 2014**

(51) **LOC (10) Cl.** **15-07**

(52) **U.S. Cl.**
USPC **D15/89**

(58) **Field of Classification Search**
USPC D15/79, 81, 84, 85, 86, 88, 89, 91
CPC F25D 2323/02; F25D 2323/021; F25D 2317/06; F25D 2317/062; F25D 2323/121; F25D 2323/122; F25D 2331/806; F25D 2400/36; F25D 13/02; F25D 13/04; F25D 11/02; F25D 11/025

See application file for complete search history.

(56) **References Cited**

U.S. PATENT DOCUMENTS

D508,249 S *	8/2005	Seok et al.	D15/86
D511,177 S *	11/2005	Jackovin et al.	D15/89
D511,179 S *	11/2005	Tunzi	D15/89
D518,832 S *	4/2006	Park et al.	D15/85
D629,819 S *	12/2010	Placke et al.	D15/89
D639,315 S *	6/2011	Yang et al.	D15/85
D647,927 S *	11/2011	Lee et al.	D15/85
D654,515 S *	2/2012	Hwang et al.	D15/85
D655,321 S *	3/2012	Lee et al.	D15/86
D707,735 S *	6/2014	Cho et al.	D15/91
D710,401 S *	8/2014	Ringemann et al.	D15/85
D710,402 S *	8/2014	Jeon et al.	D15/86

D716,851 S *	11/2014	Seo et al.	D15/89
D718,346 S *	11/2014	Cho et al.	D15/81
D718,349 S *	11/2014	Cho et al.	D15/85

* cited by examiner

Primary Examiner — Ian Simmons
Assistant Examiner — Khawaja Anwar

(57) **CLAIM**

We claim the ornamental design for an appliance interior with color, as shown and described.

DESCRIPTION

FIG. 1 is a perspective view of an appliance interior with color in a closed configuration according to a first embodiment of our design;
 FIG. 2 is a front elevation view thereof;
 FIG. 3 is a left side elevation view thereof;
 FIG. 4 is a top plan view thereof;
 FIG. 5 is a bottom plan view thereof;
 FIG. 6 is a front perspective view of the appliance interior with color of FIG. 1 shown in an open configuration;
 FIG. 7 is an enlarged top left perspective view thereof;
 FIG. 8 is an enlarged top right perspective view thereof;
 FIG. 9 is a front elevation view thereof;
 FIG. 10 is a partial left perspective view thereof;
 FIG. 11 is a partial front elevation view thereof;
 FIG. 12 is a partial left perspective view thereof in a first use condition of the open configuration;
 FIG. 13 is a partial front elevation view of a right portion thereof;
 FIG. 14 is a partial right perspective view thereof;
 FIG. 15 is a partial front elevation view thereof;
 FIG. 16 is a partial right perspective view thereof in a second use configuration of the open configuration;
 FIG. 17 is a partial front elevation view thereof;
 FIG. 18 is a perspective view of an appliance interior with color in a closed configuration according to a second embodiment of our design;
 FIG. 19 is a front elevation view thereof;
 FIG. 20 is a left side elevation view thereof;
 FIG. 21 is a top plan view thereof;
 FIG. 22 is a bottom plan view thereof;

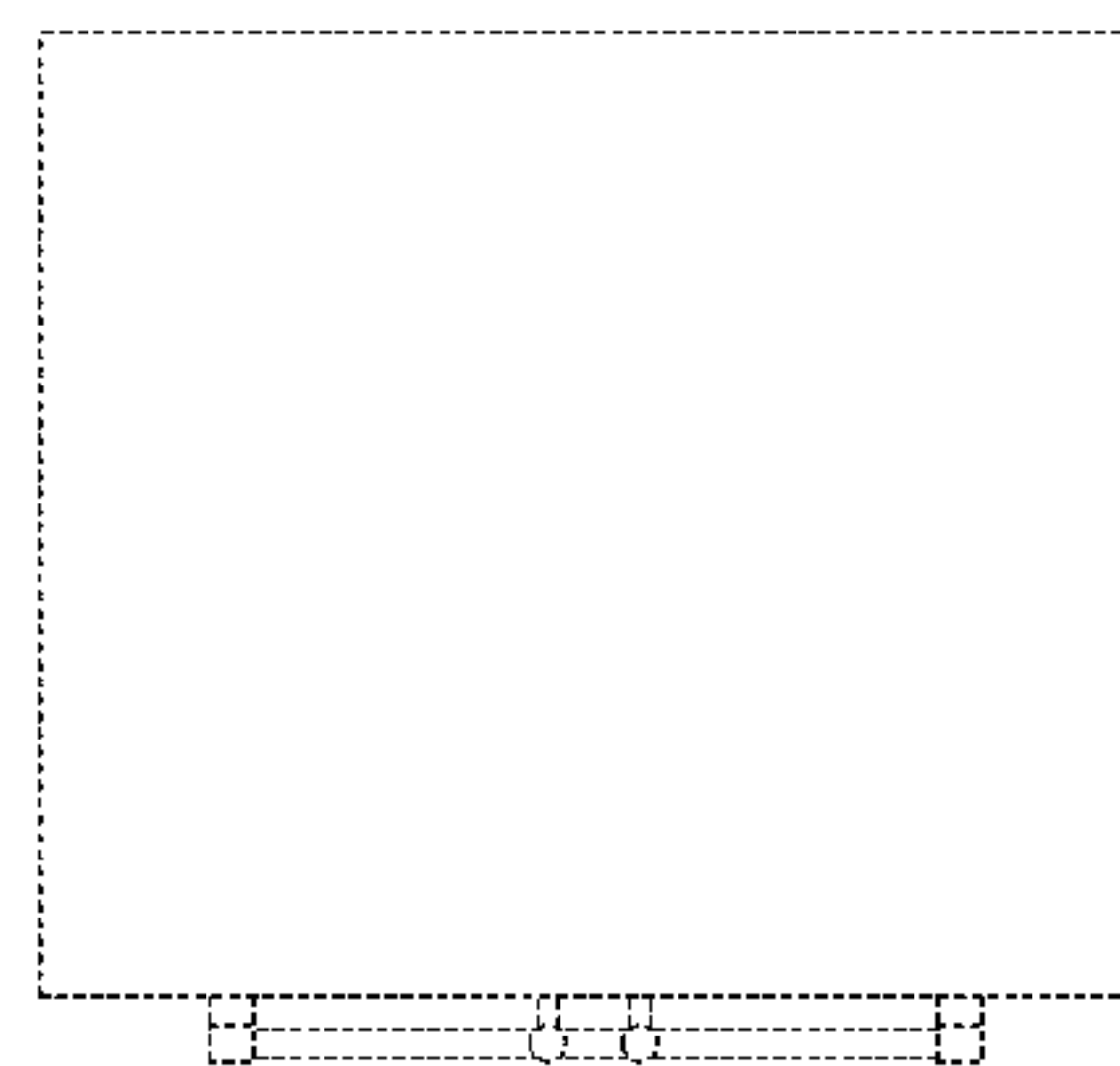
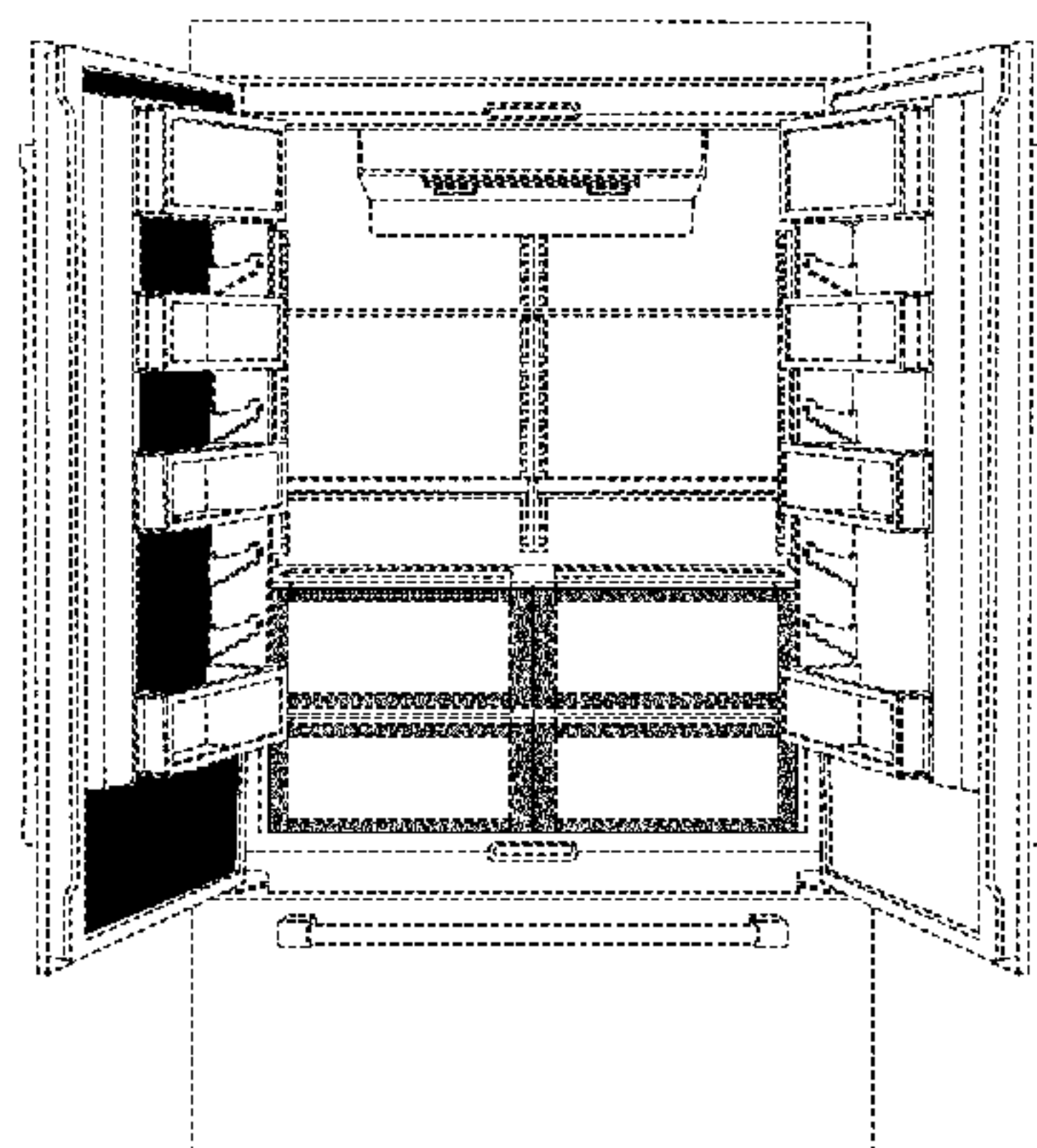

FIG. 23 is a front elevation view the appliance interior with color of FIG. 18 shown in an open configuration;
FIG. 24 is an enlarged top left perspective view thereof;
FIG. 25 is an enlarged top right perspective view thereof;
FIG. 26 is a front elevation view thereof;
FIG. 27 is a partial left perspective view thereof in a first use condition of the open configuration;
FIG. 28 is a partial front elevation view thereof;
FIG. 29 is a partial left perspective view thereof;
FIG. 30 is a partial front elevation view of the interior of a right portion thereof;
FIG. 31 is a partial right perspective view thereof;
FIG. 32 is a partial front elevation view thereof;
FIG. 33 is a partial right perspective view thereof in a second use condition of the open configuration;
FIG. 34 is a partial front elevation view thereof;
FIG. 35 is a perspective view of an appliance interior with color in a closed configuration according to a third embodiment of our design;
FIG. 36 is a front elevation view thereof;
FIG. 37 is a left side elevation thereof;
FIG. 38 is a top plan view thereof;
FIG. 39 is a bottom plan view thereof;
FIG. 40 is a front elevation view the appliance interior with color of FIG. 35 shown in an open configuration;
FIG. 41 is an enlarged top left perspective view thereof;
FIG. 42 is an enlarged top right perspective view thereof;
FIG. 43 is a front elevation view thereof;

FIG. 44 is a partial left perspective view thereof in a first use condition of the open configuration;
FIG. 45 is a partial front elevation view thereof;
FIG. 46 is a partial left perspective view thereof;
FIG. 47 is a partial front elevation view of a right portion thereof;
FIG. 48 is a partial right perspective view thereof;
FIG. 49 is a partial front elevation view thereof;
FIG. 50 is a partial right perspective view thereof in a second use condition of the open configuration; and,
FIG. 51 is a partial front elevation view thereof.

The broken lines in the figures are to show an environment and form no part of the claimed design.

The comparatively light tone fill on the front portions of the front drawer doors of the crispers is used to indicate a matte metallic silver color having the following characteristics:

H: 0

S: 0

V: 78 (+/-7%).

The comparatively dark tone fill on the door liner of the left, right or both the left and the right door interior is used to indicate a charcoal gray color having the following characteristics according to the CIELAB system:

L 38.92

a-1.00

b-1.80.

1 Claim, 48 Drawing Sheets

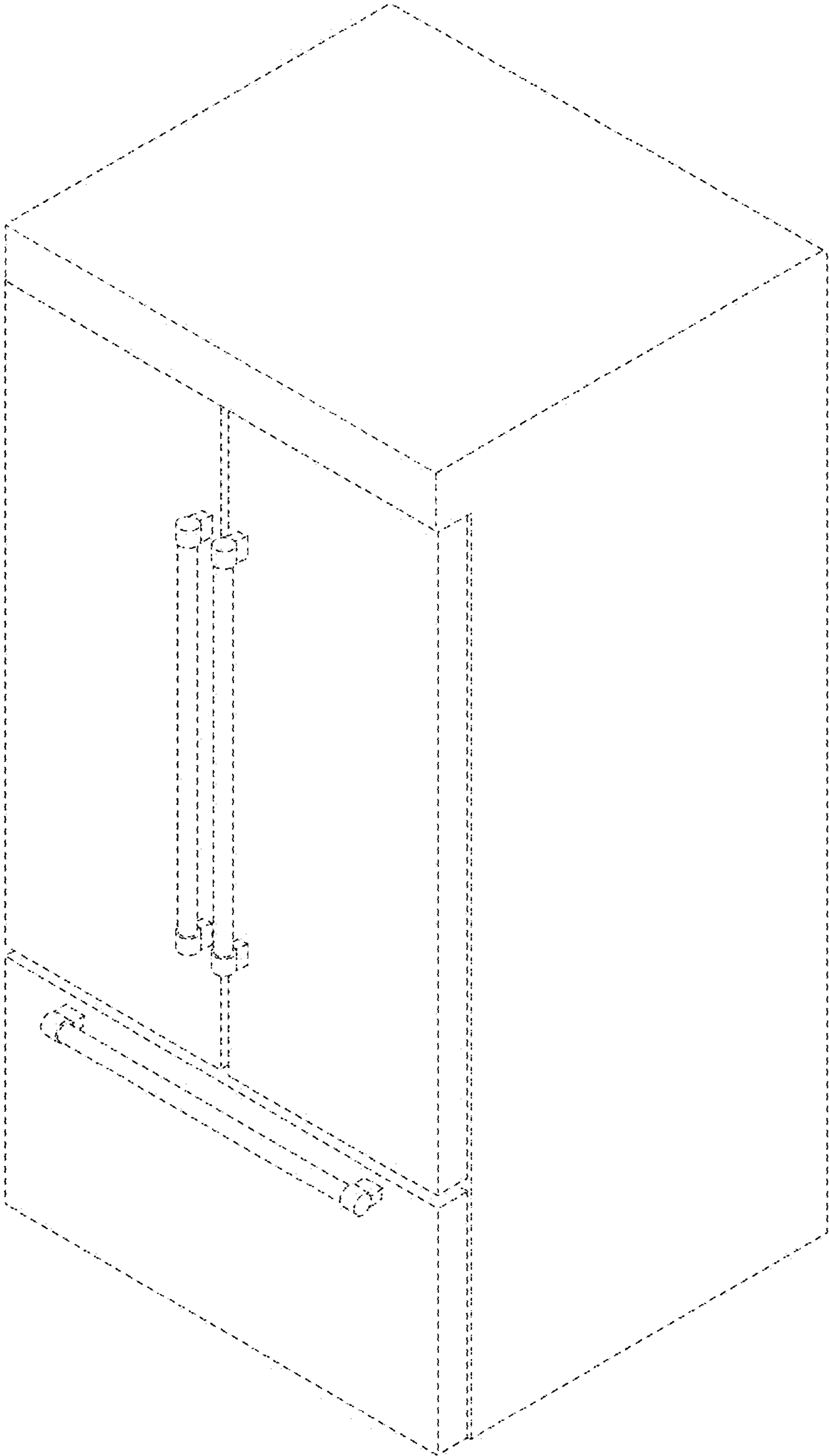

FIG. 1

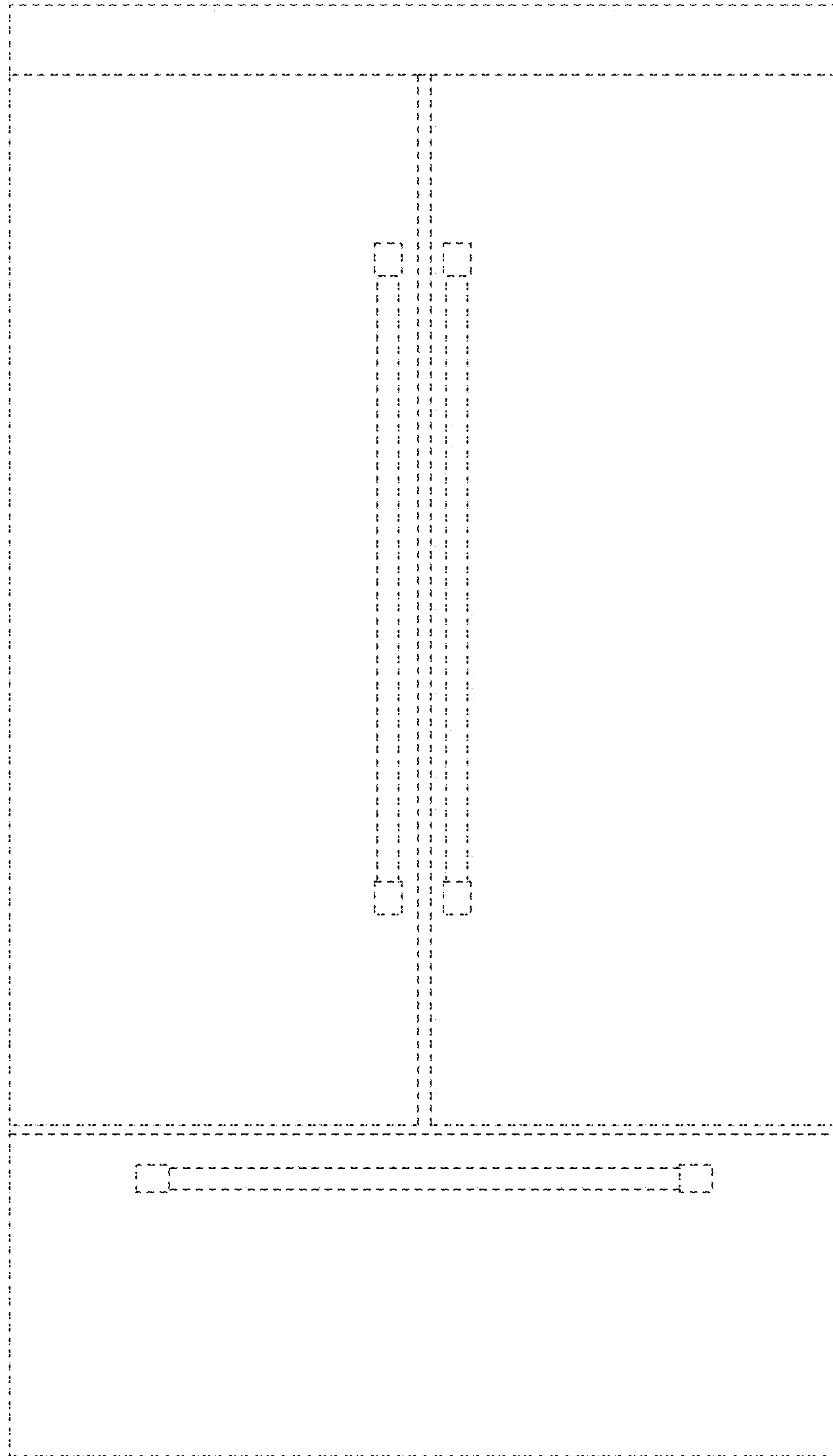

FIG. 2



FIG. 3

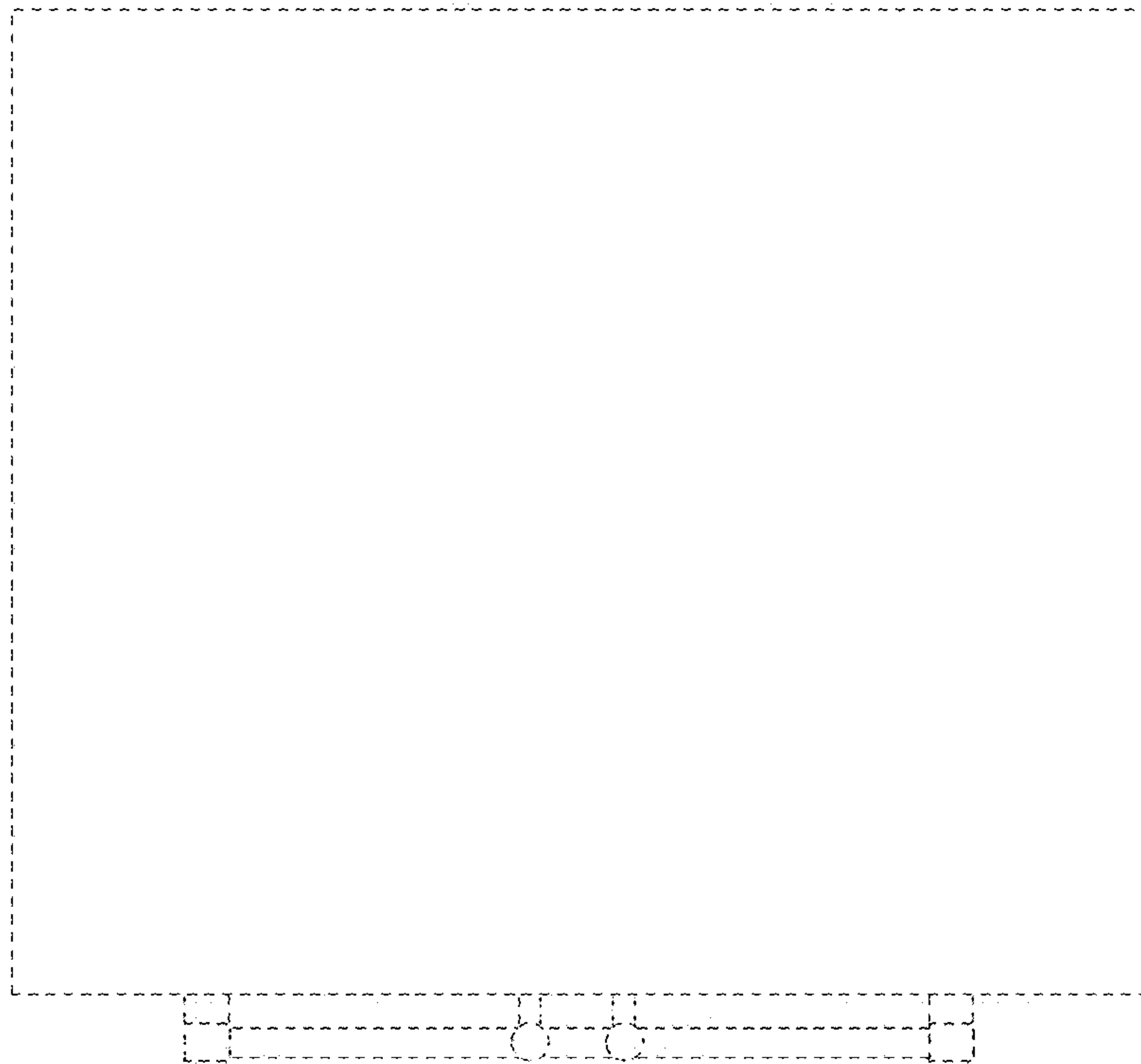

FIG. 4

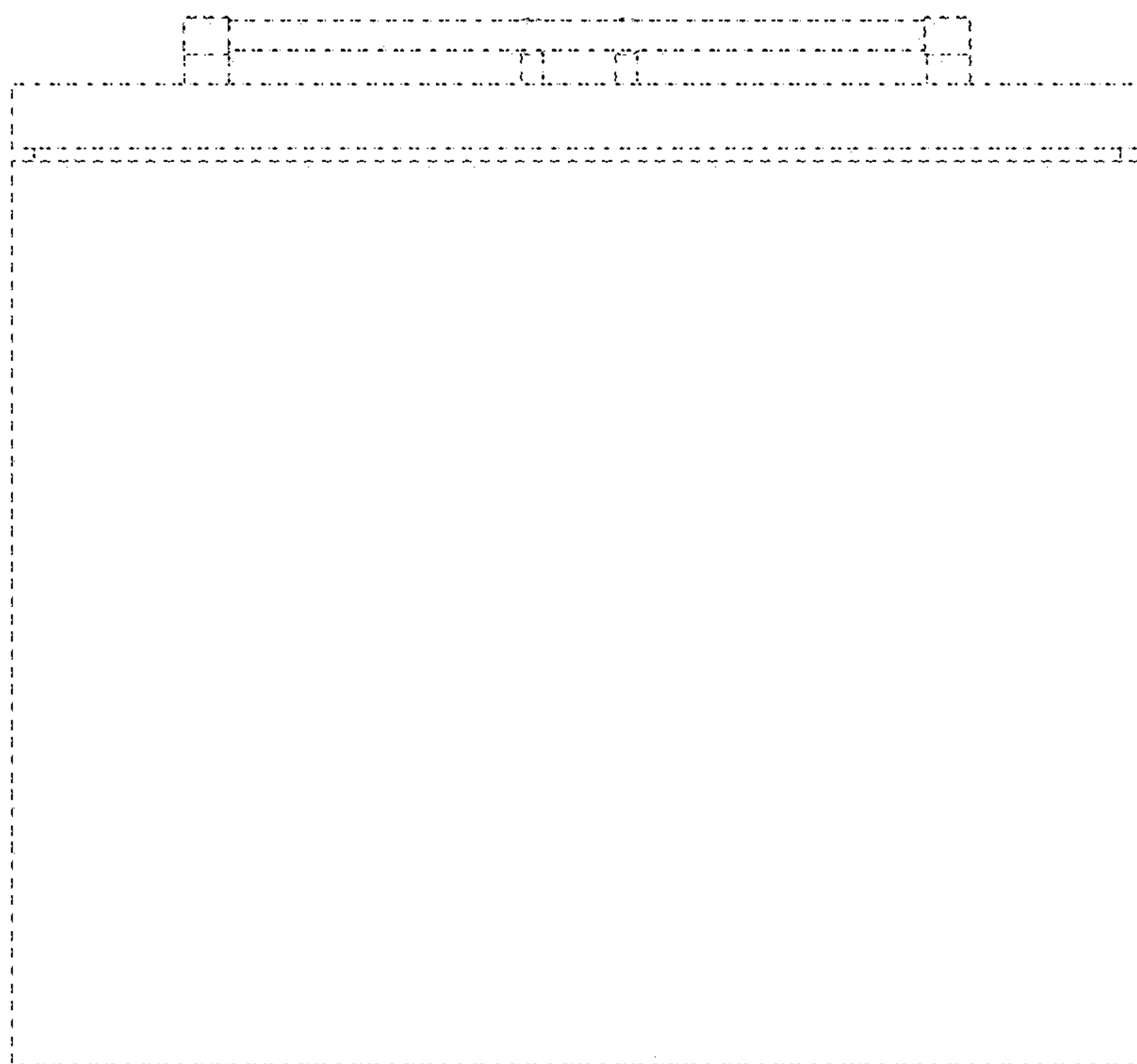

FIG. 5

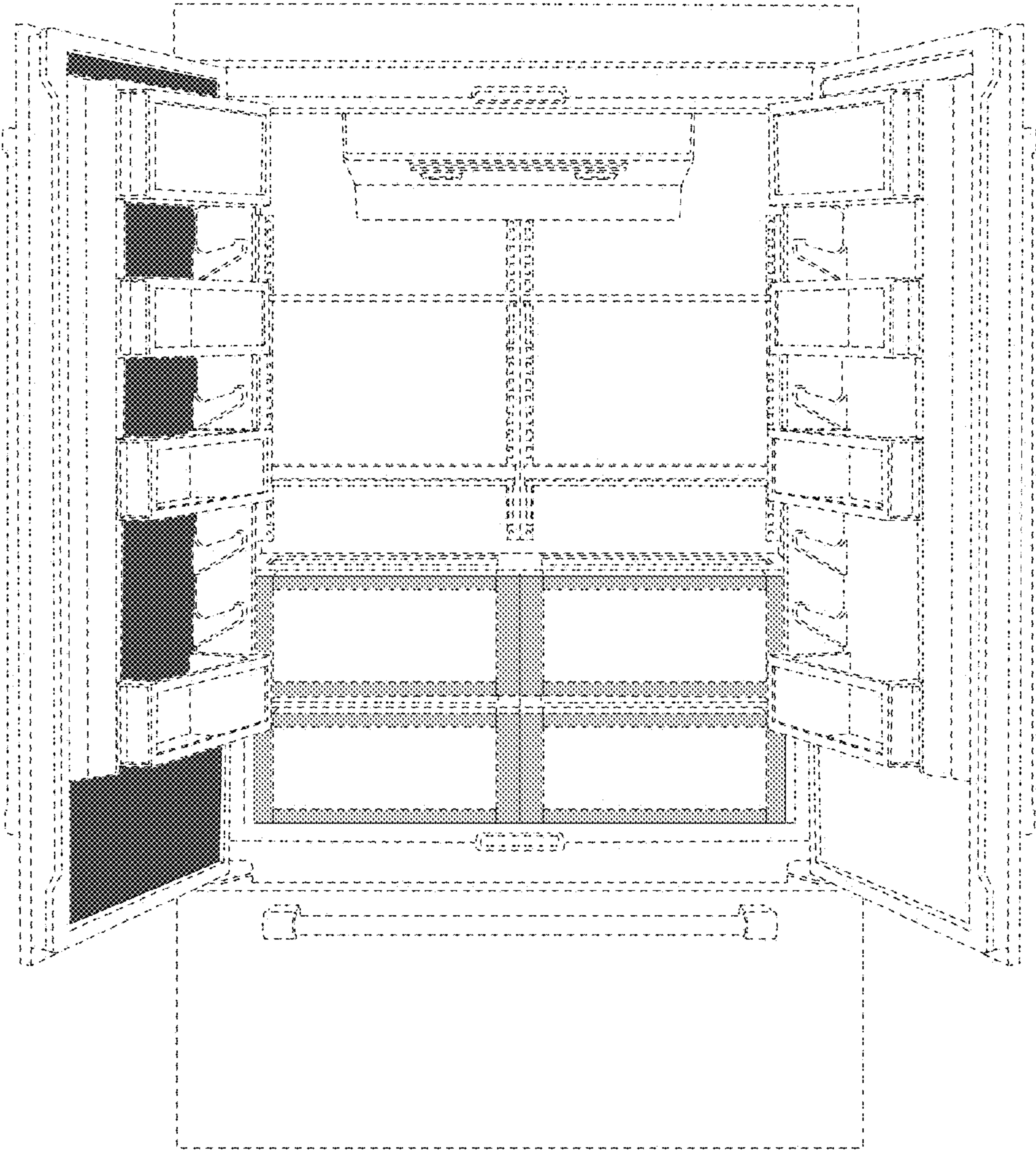

FIG. 6

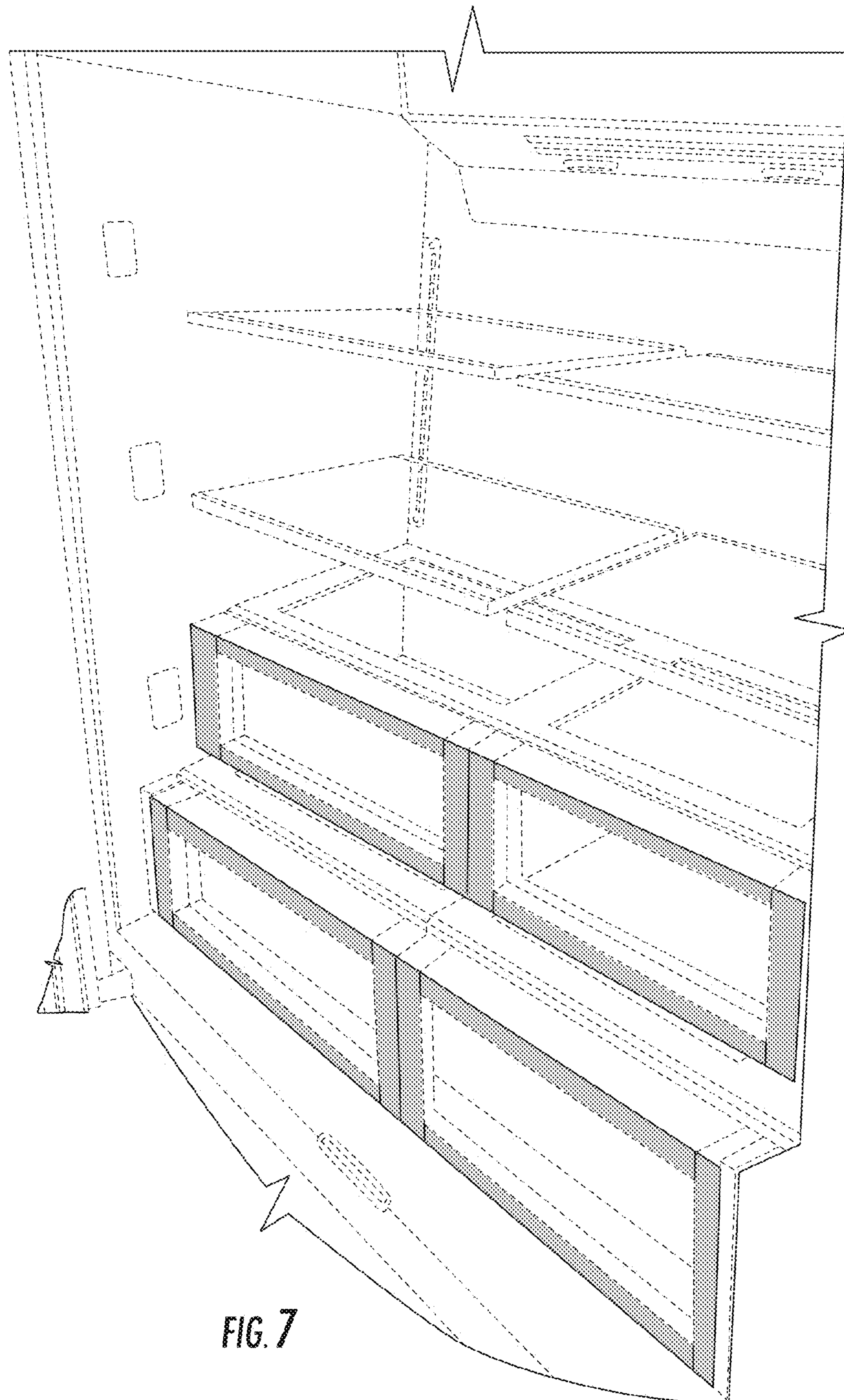

FIG. 7

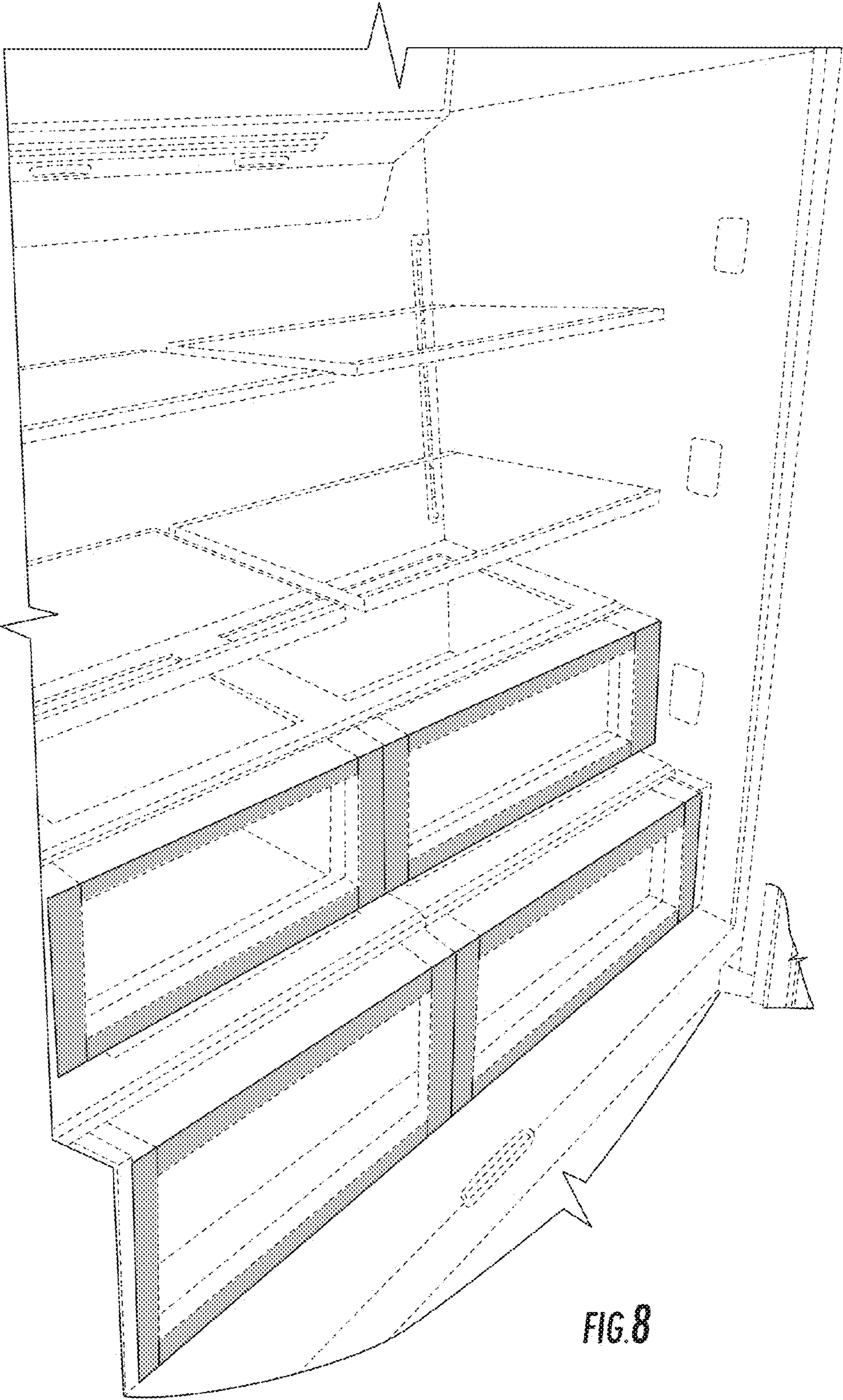

FIG. 8

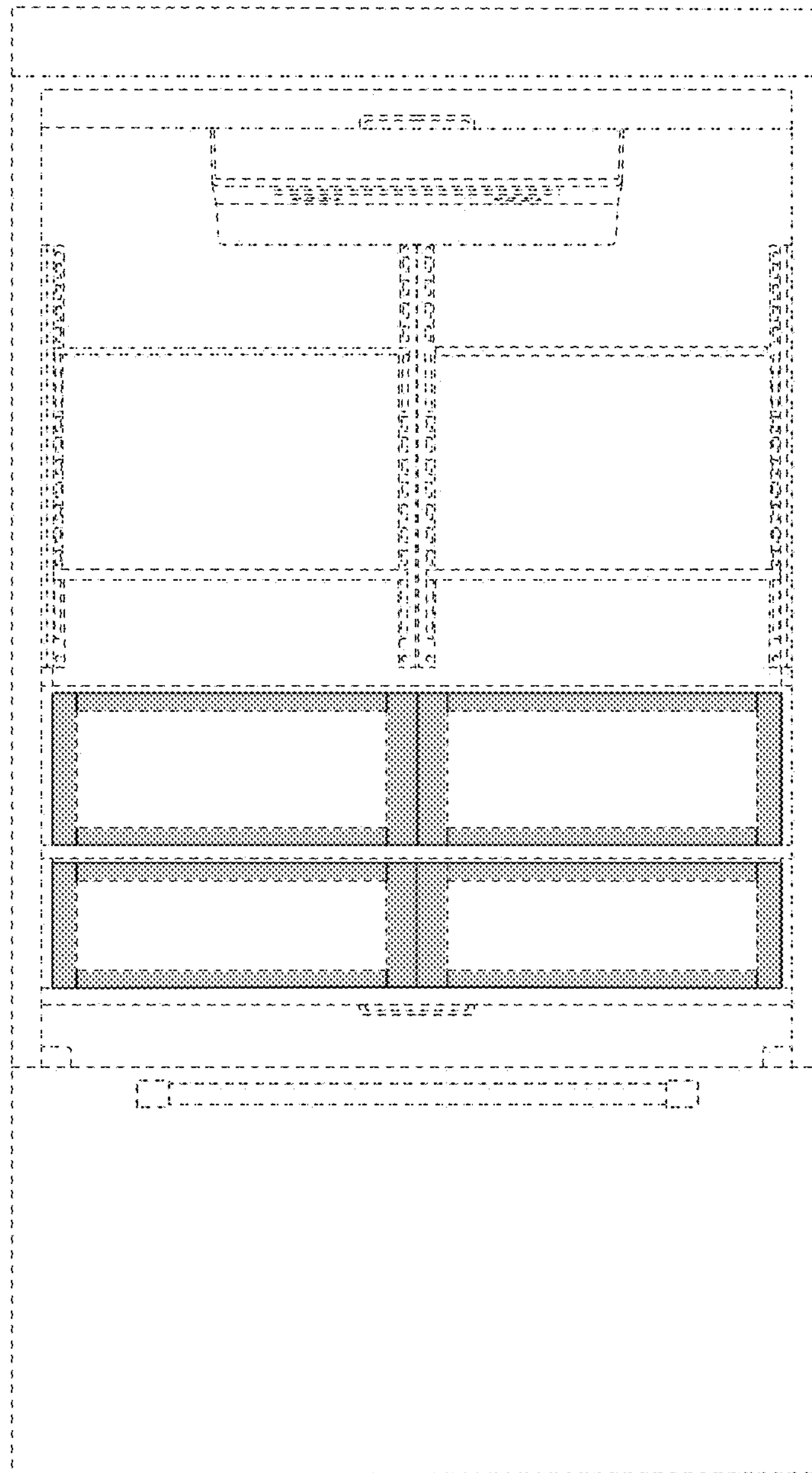

FIG. 9

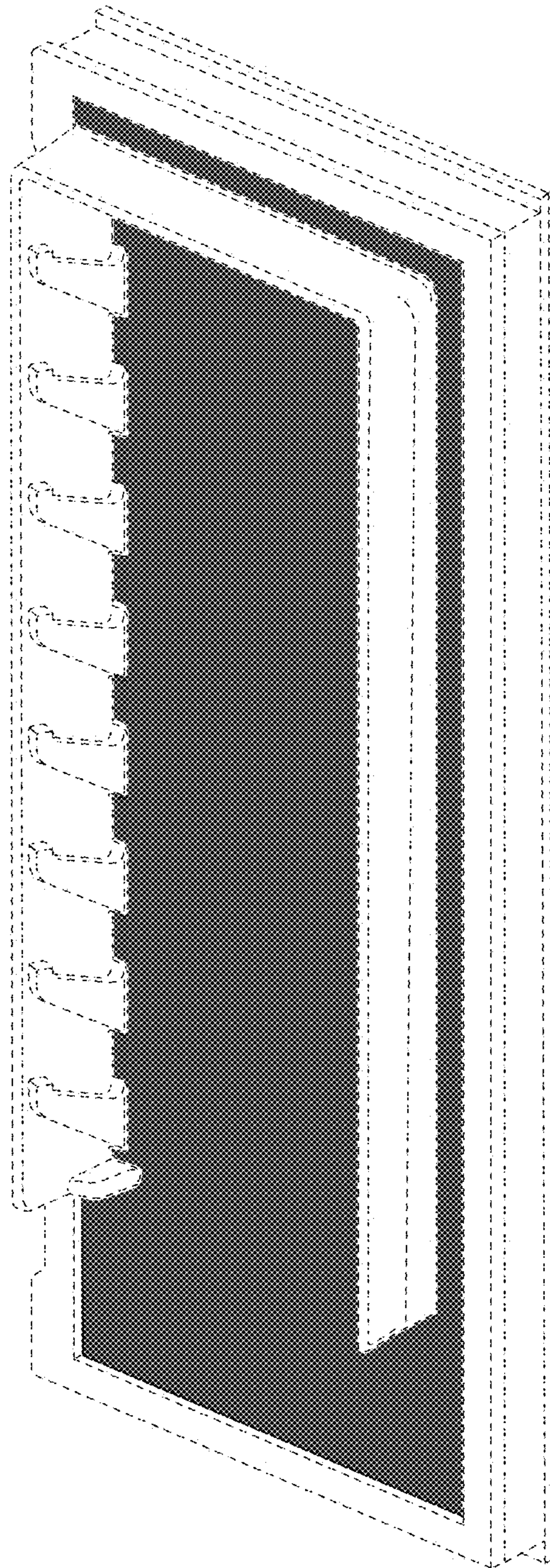

FIG. 10

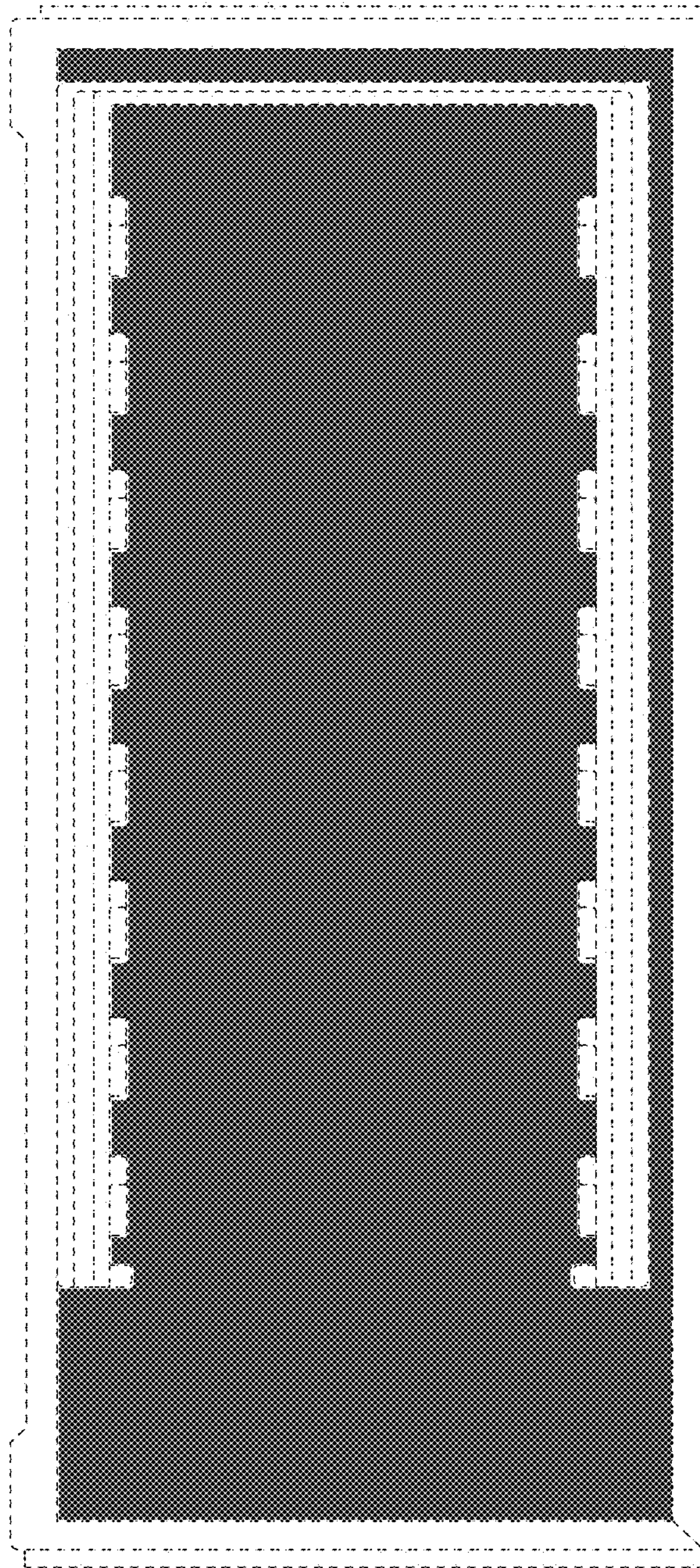

FIG. 11

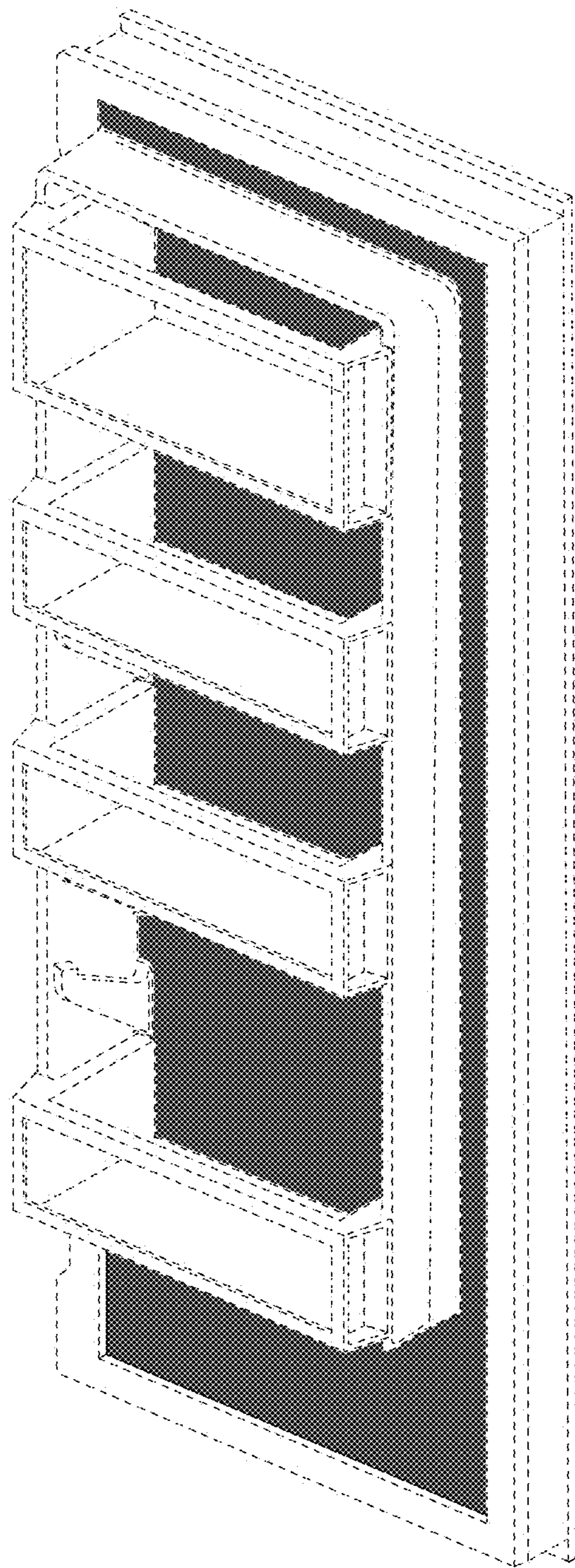

FIG. 12

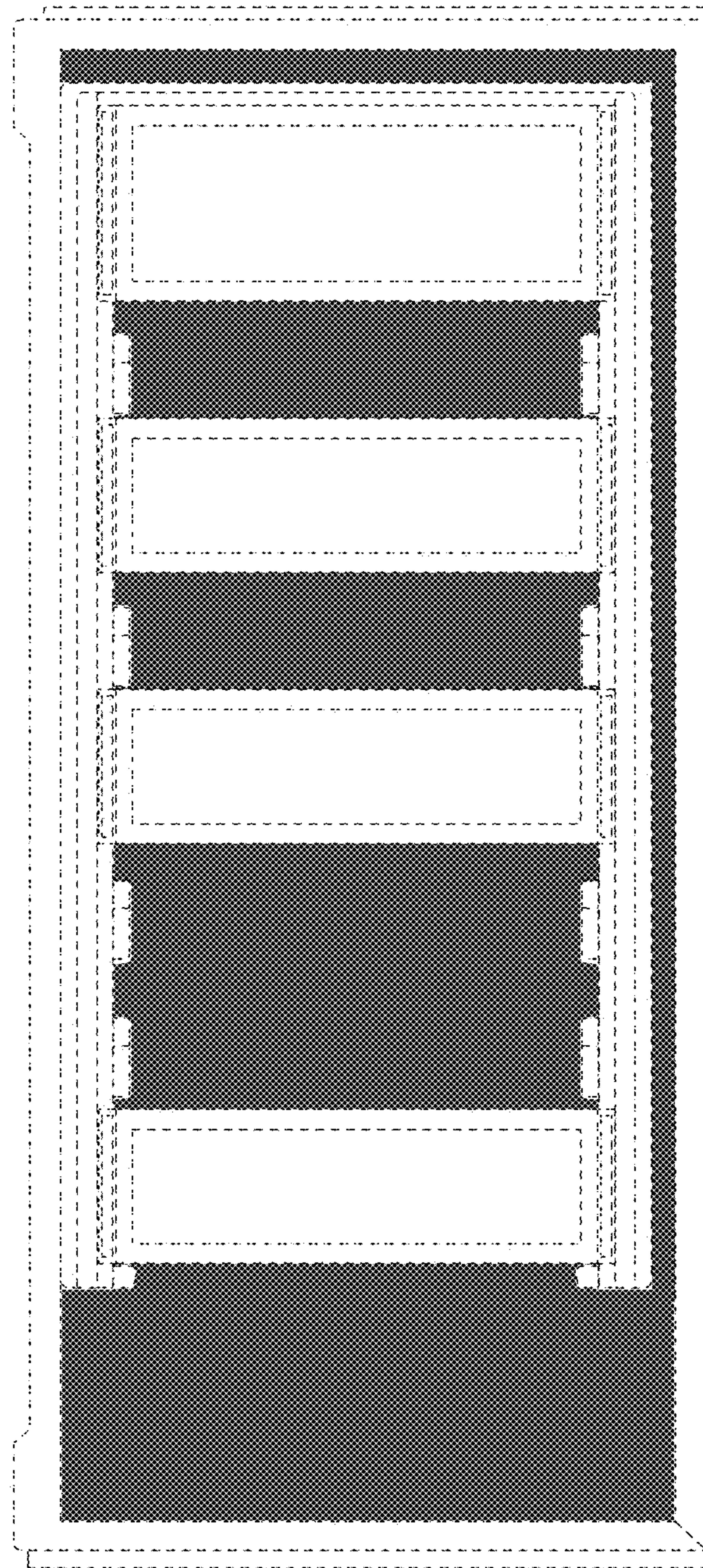

FIG. 13

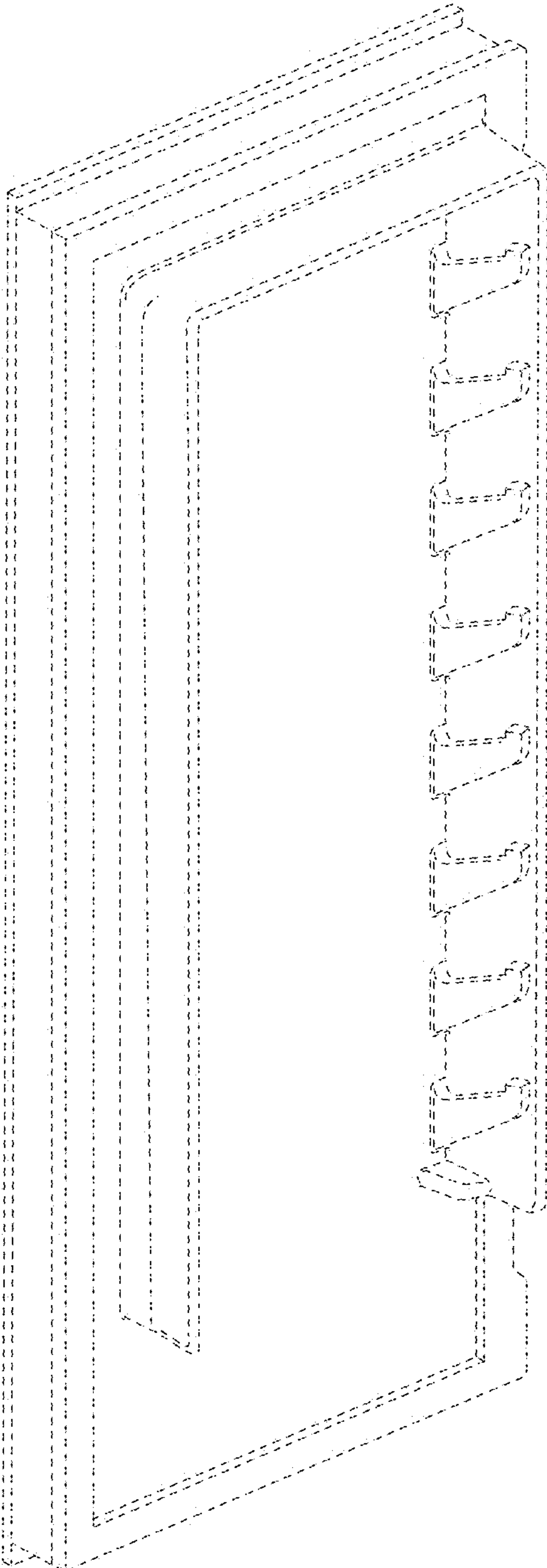

FIG. 14

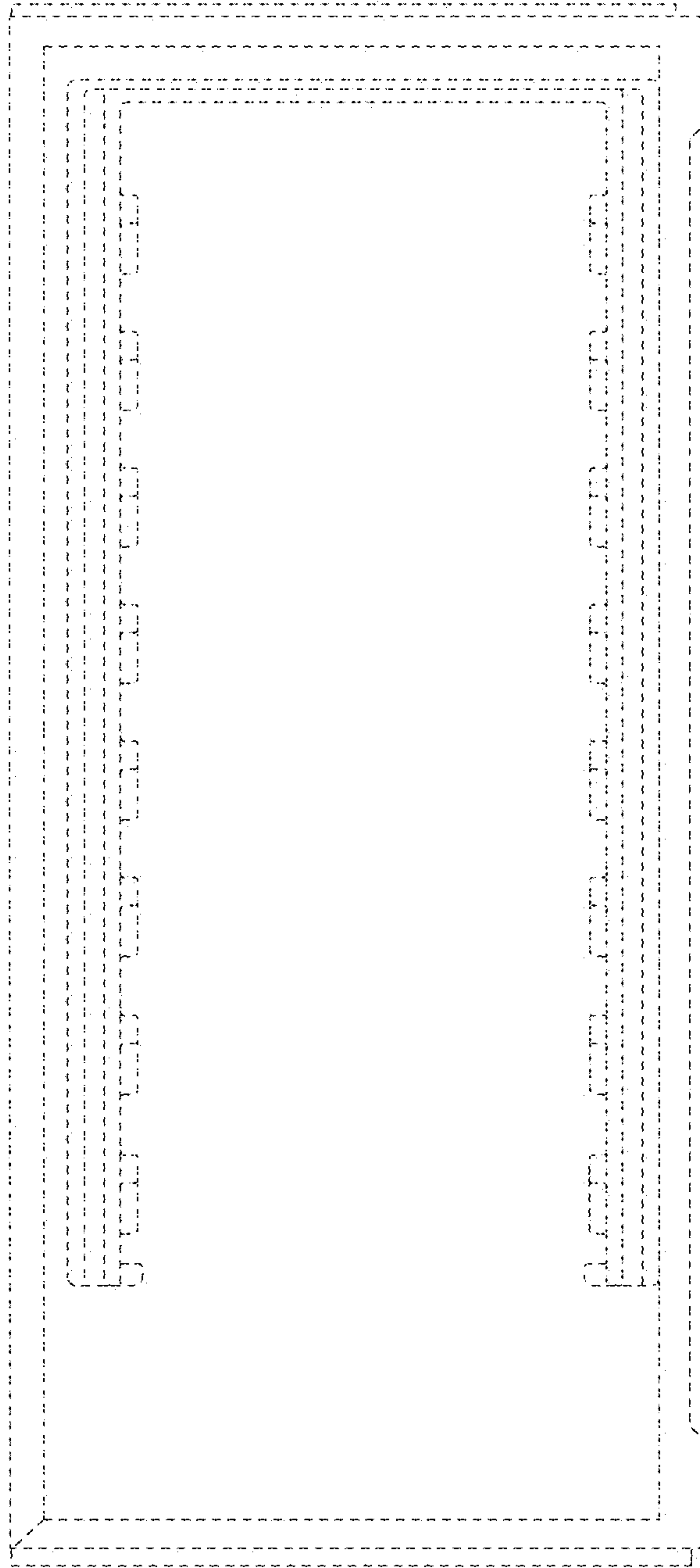

FIG. 15

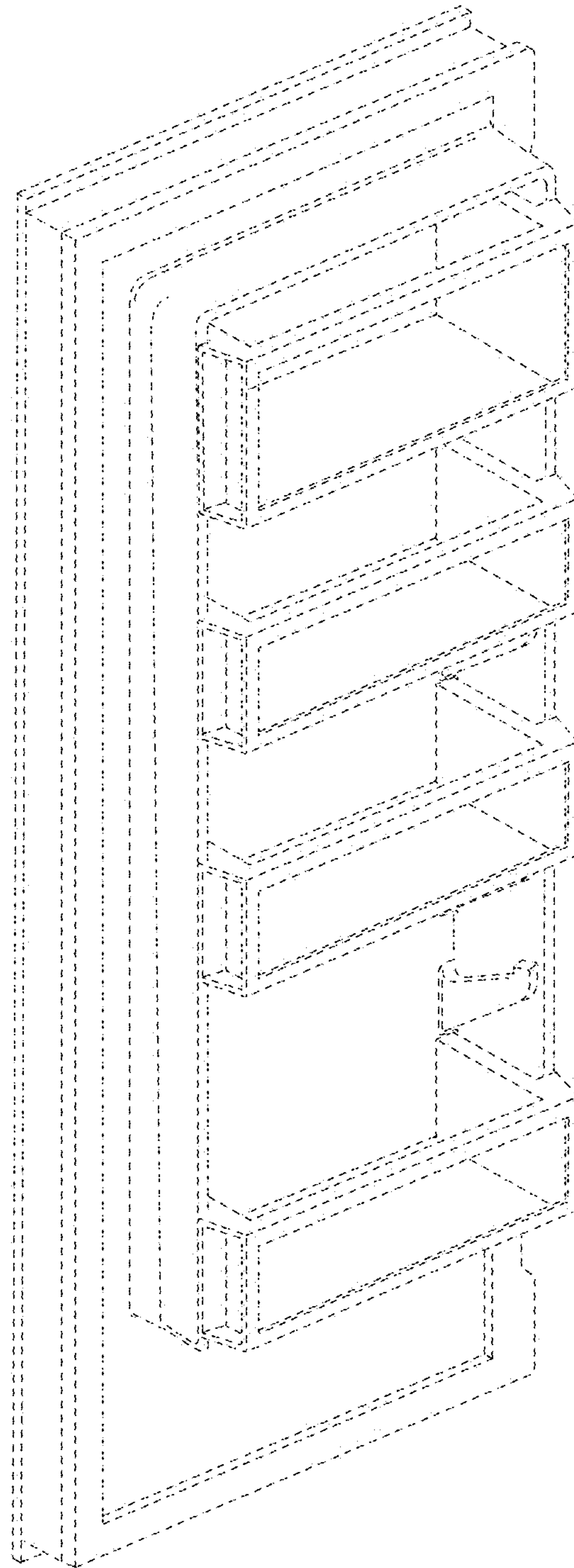

FIG. 16

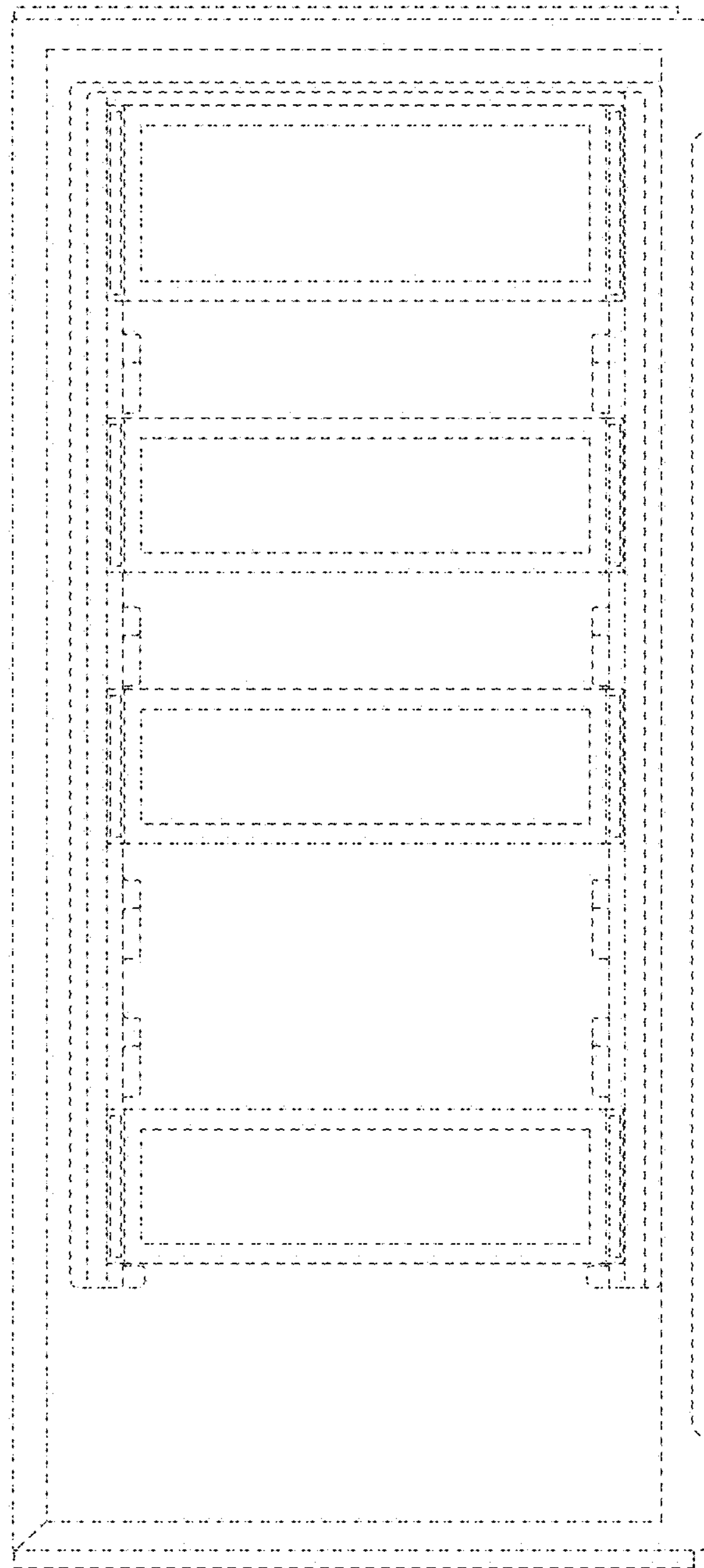

FIG. 17

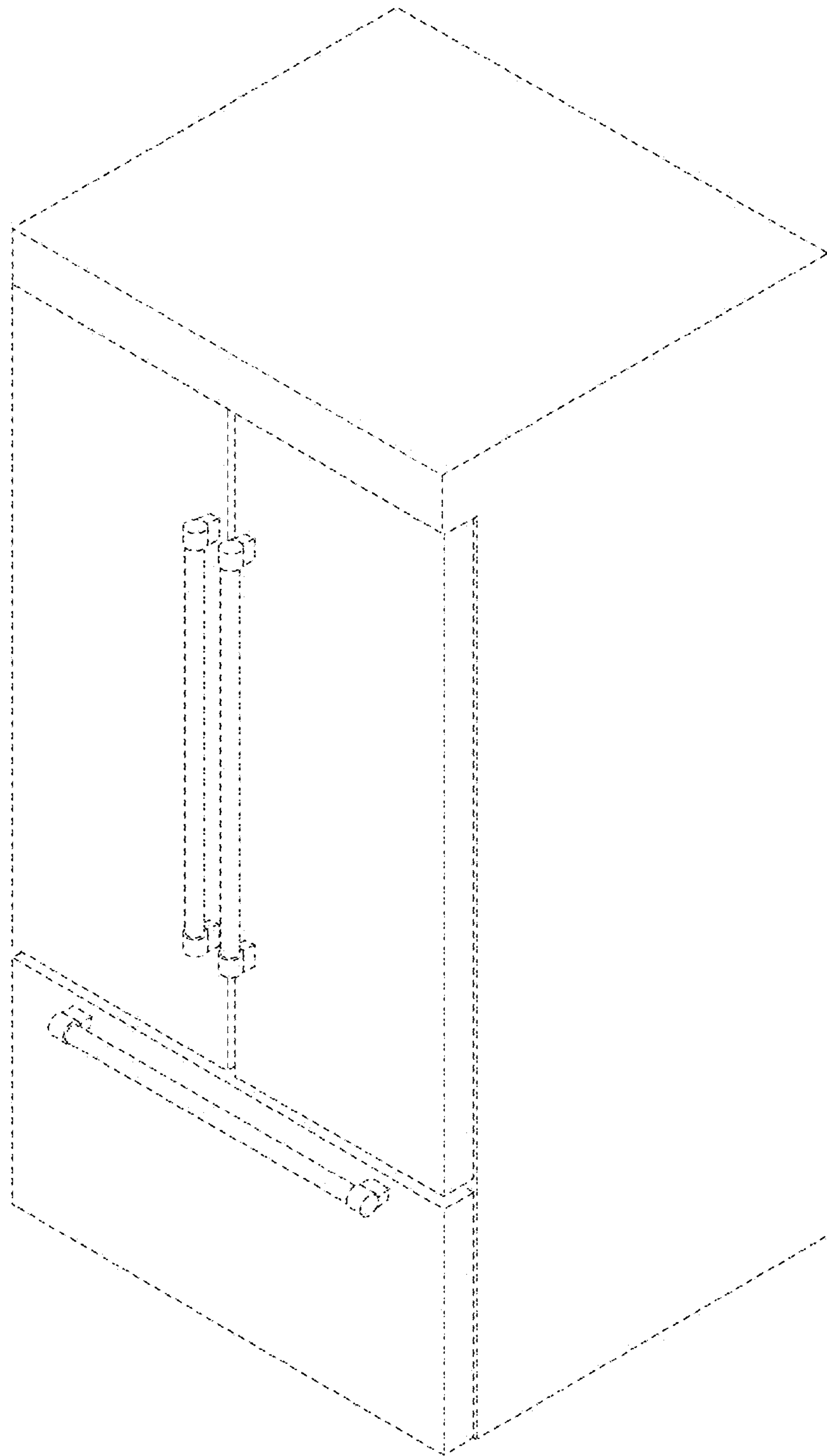

FIG. 18

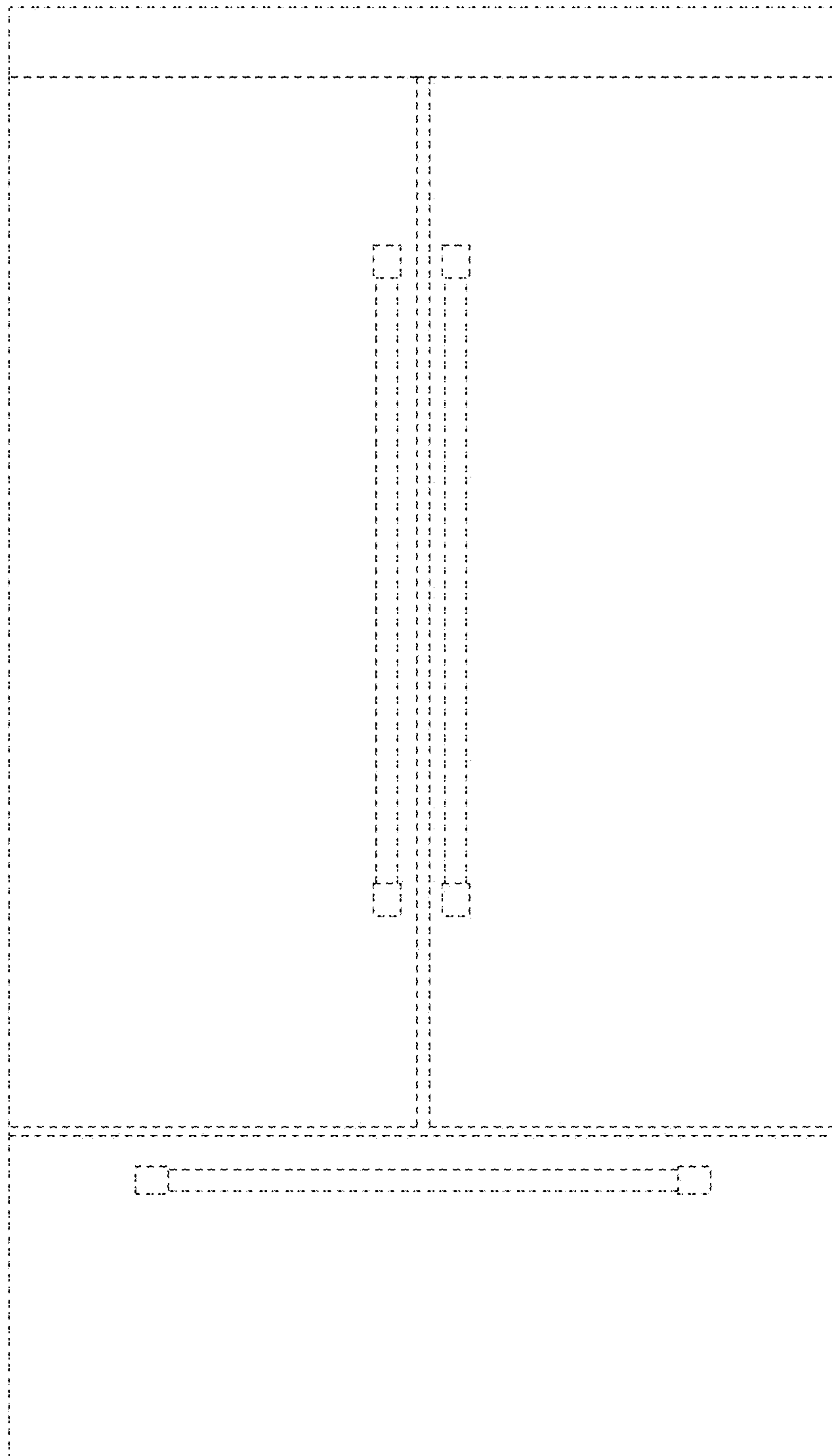

FIG. 19



FIG. 20

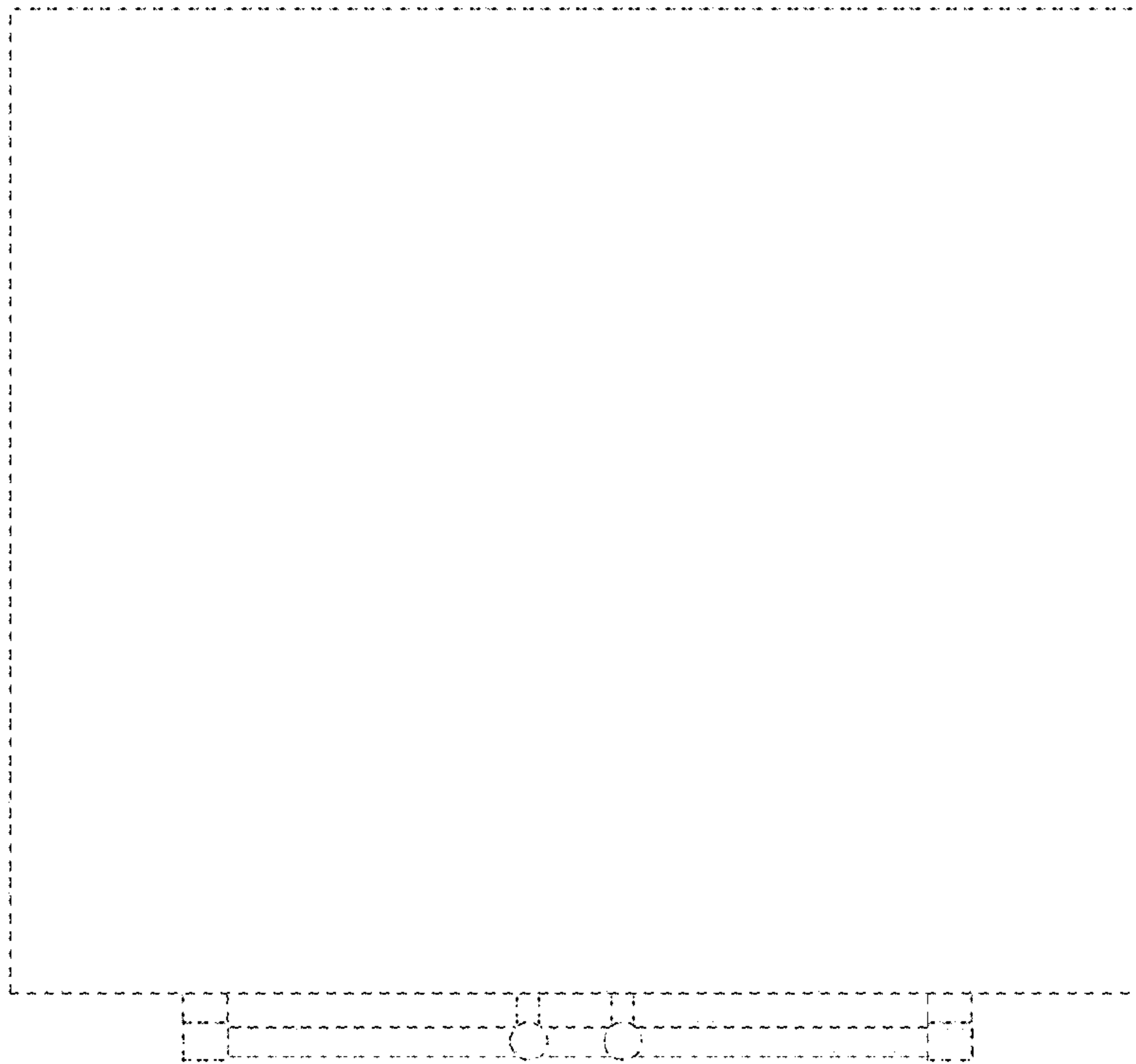

FIG. 21

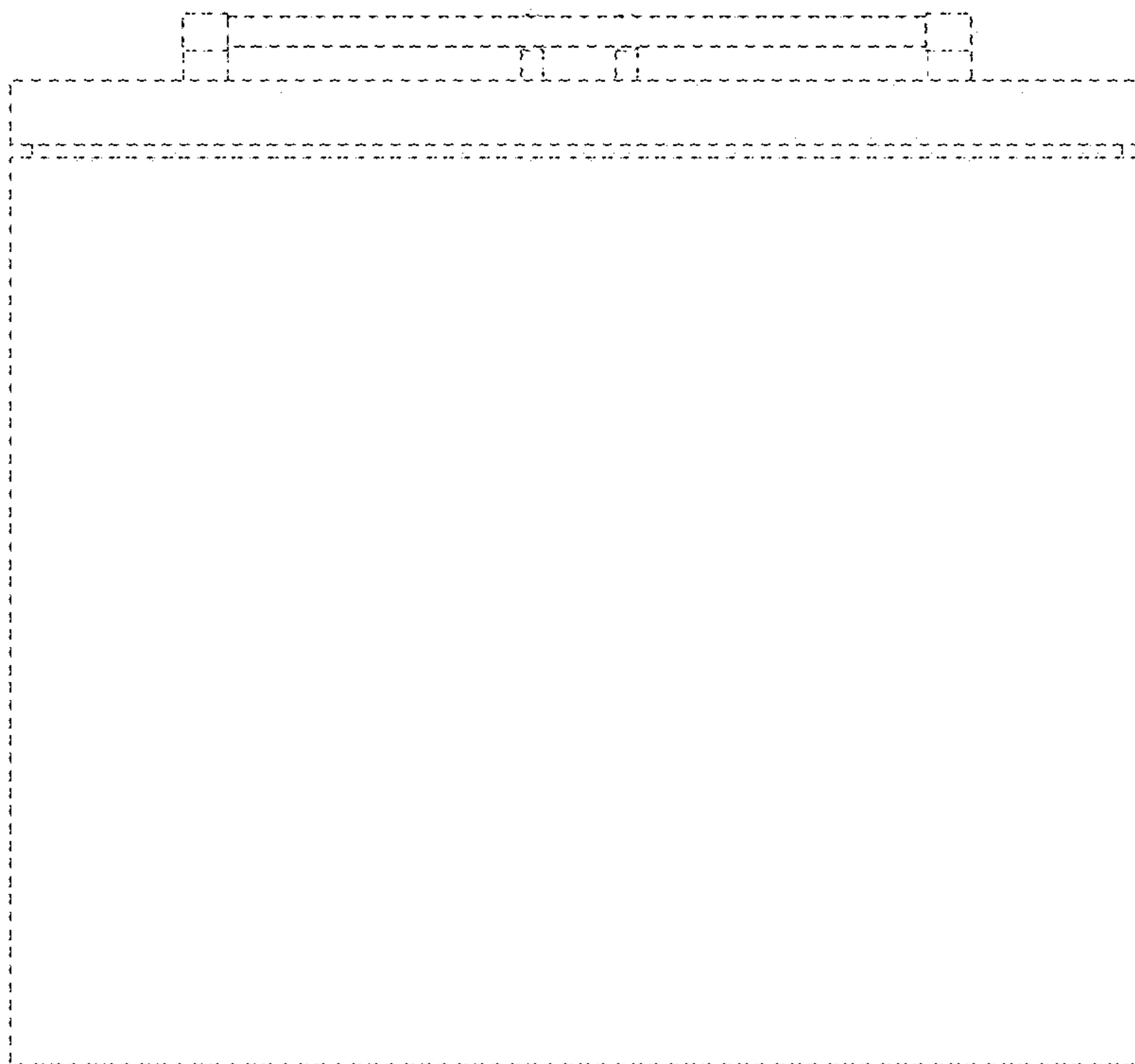

FIG. 22

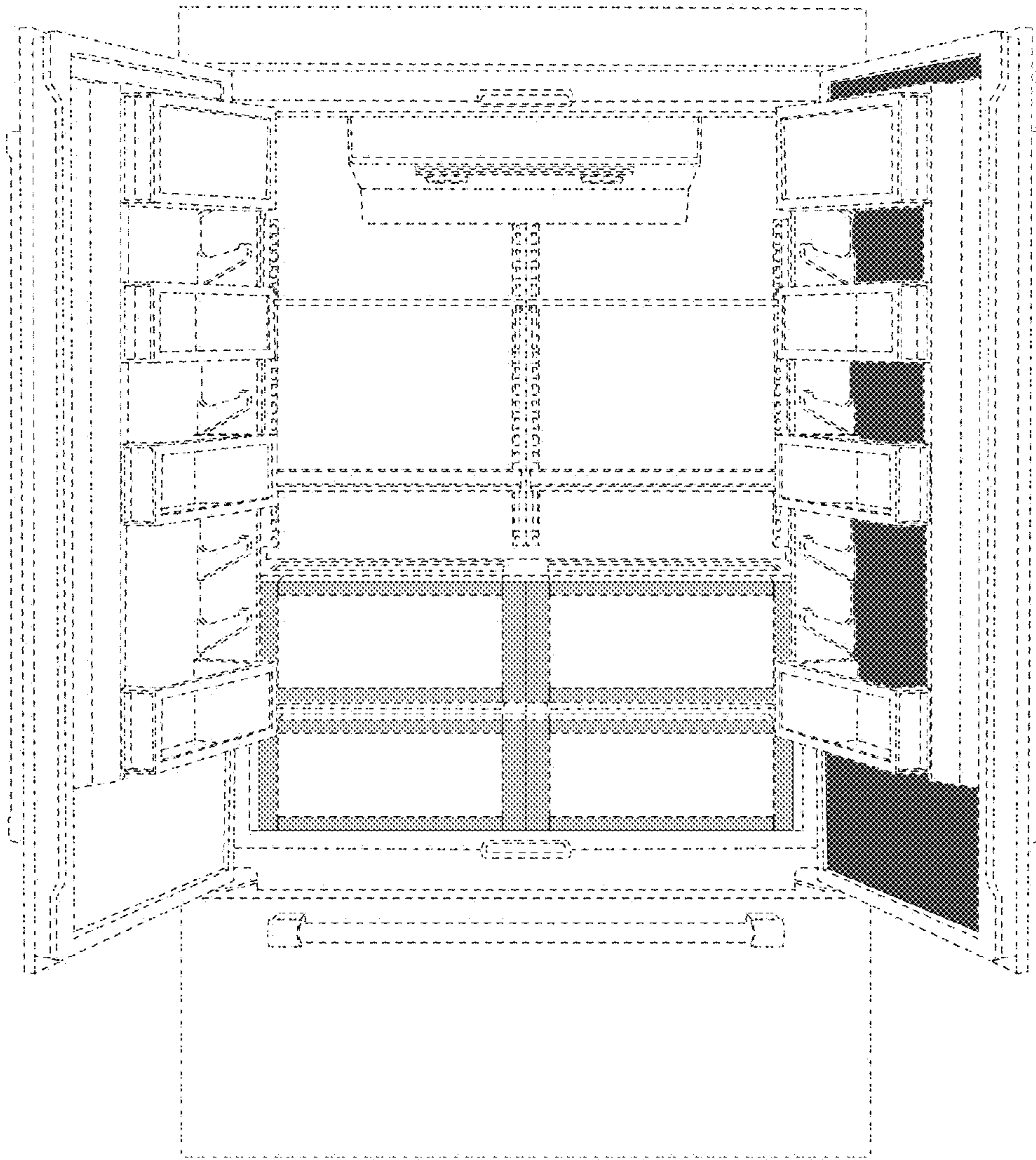

FIG. 23

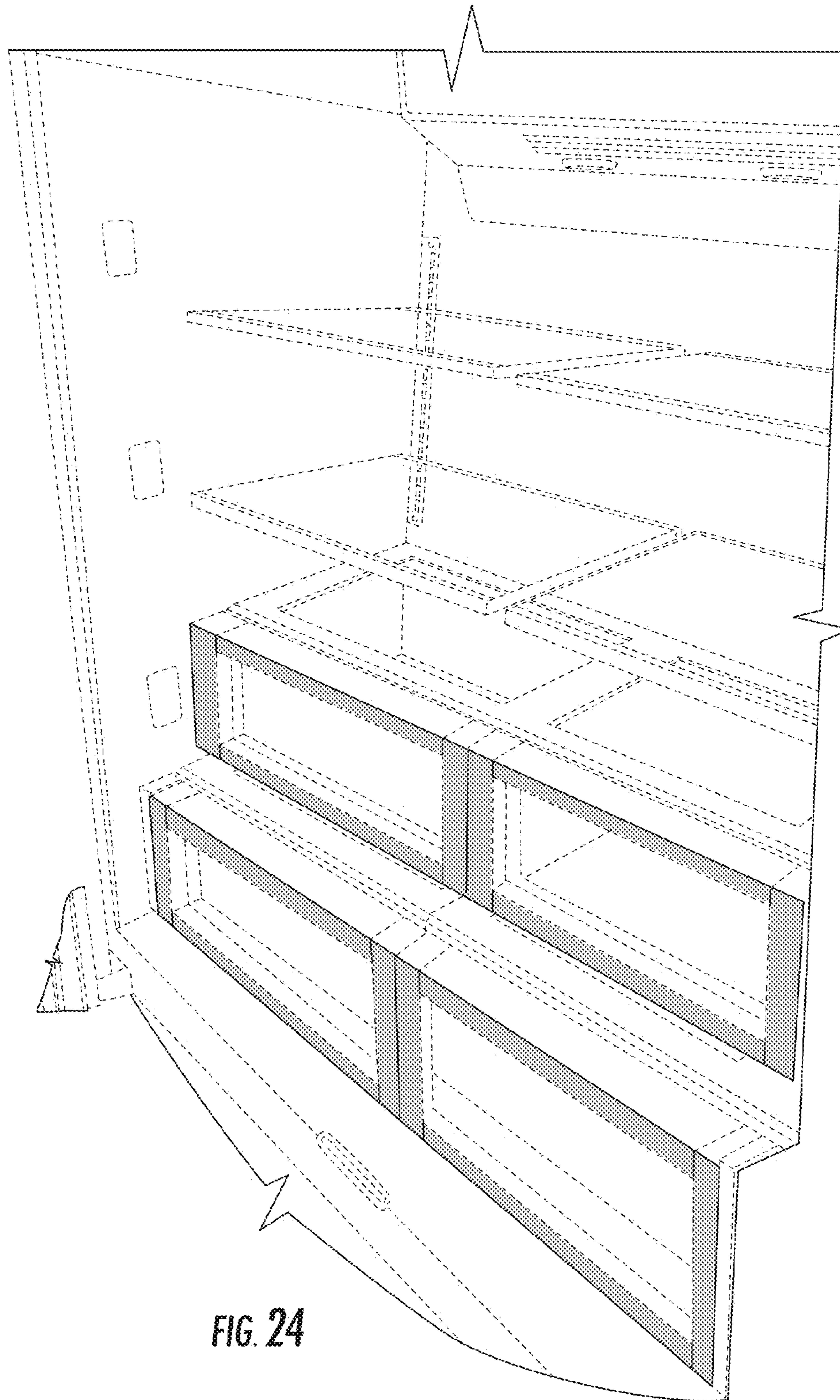
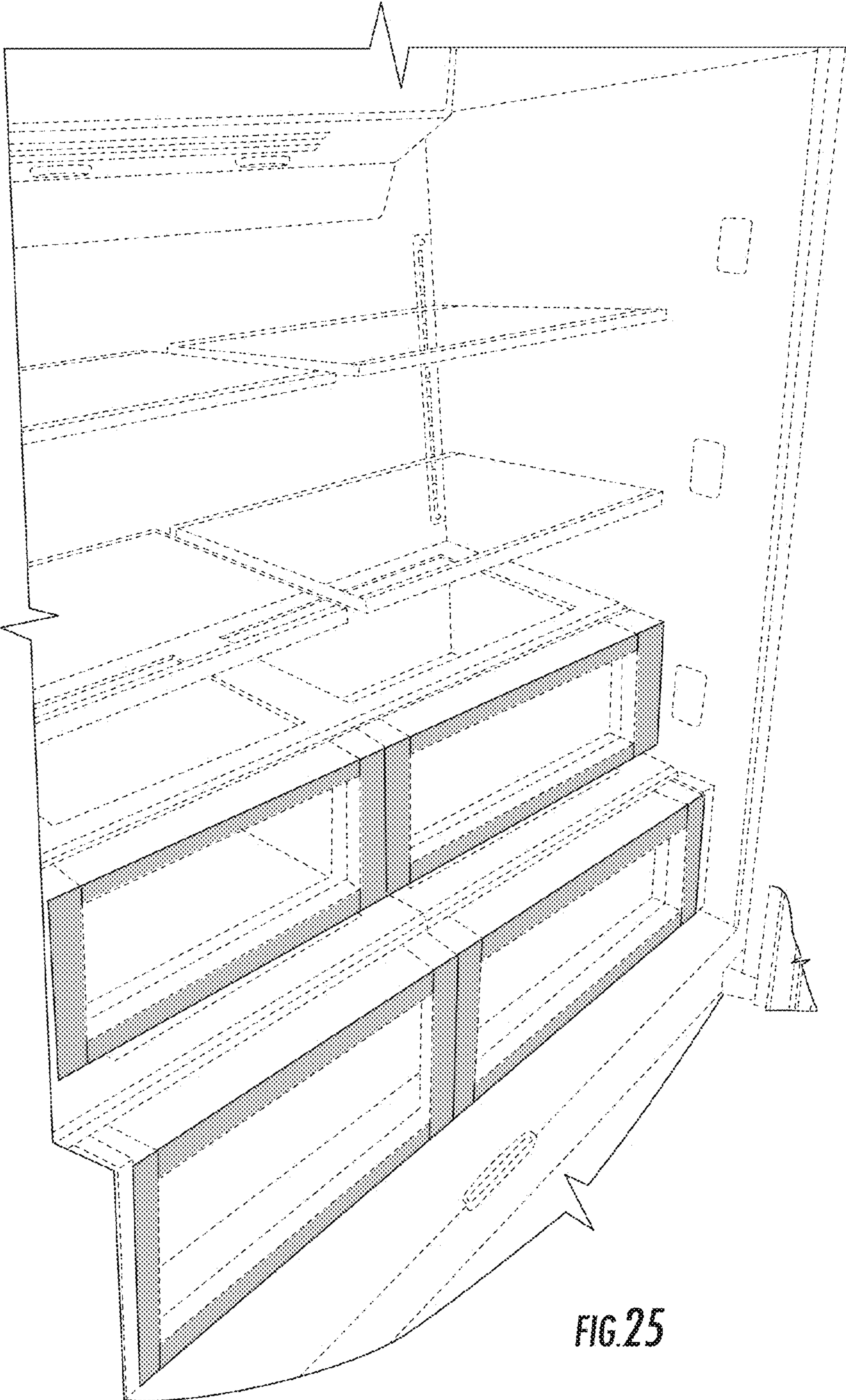

FIG. 24



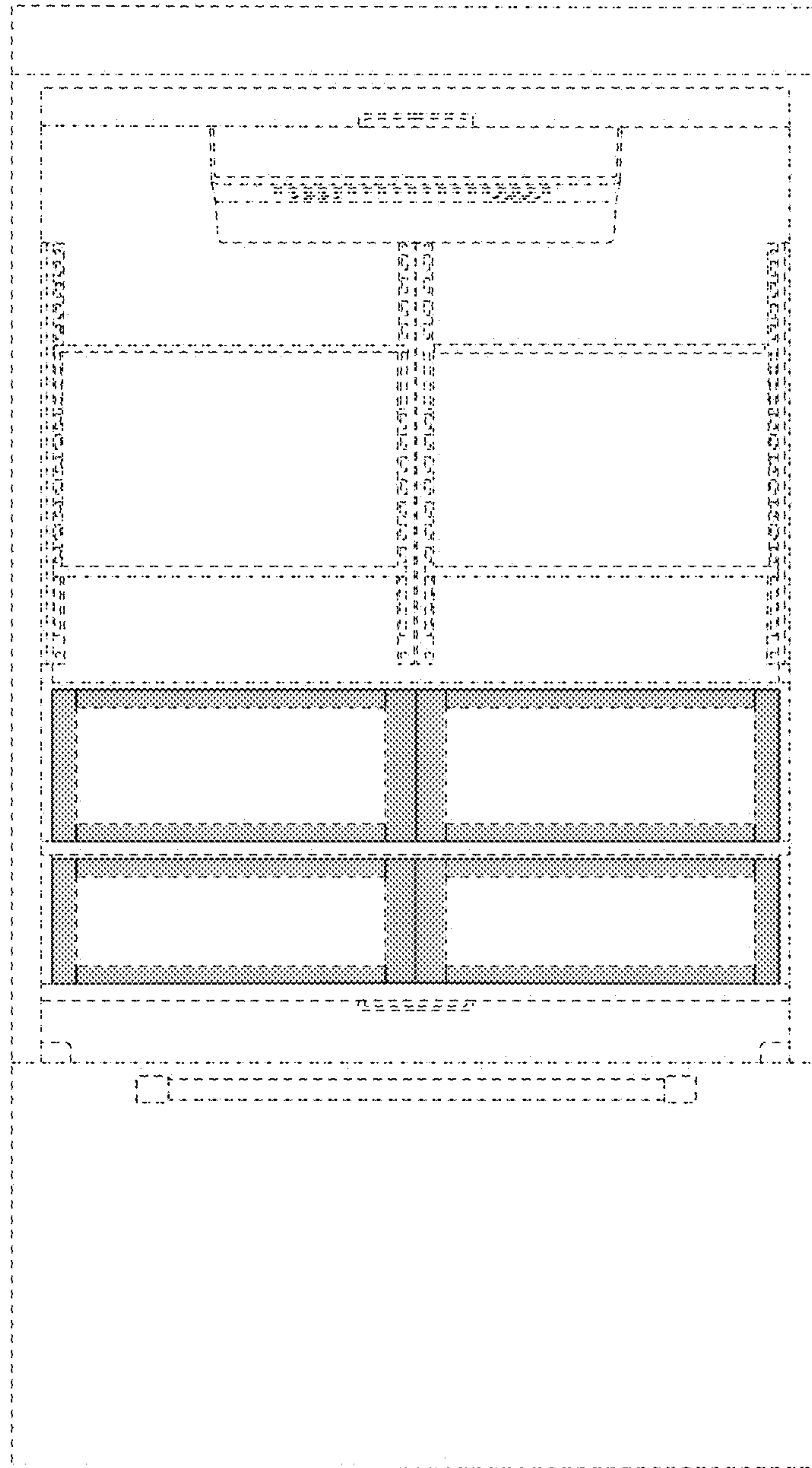

FIG. 26

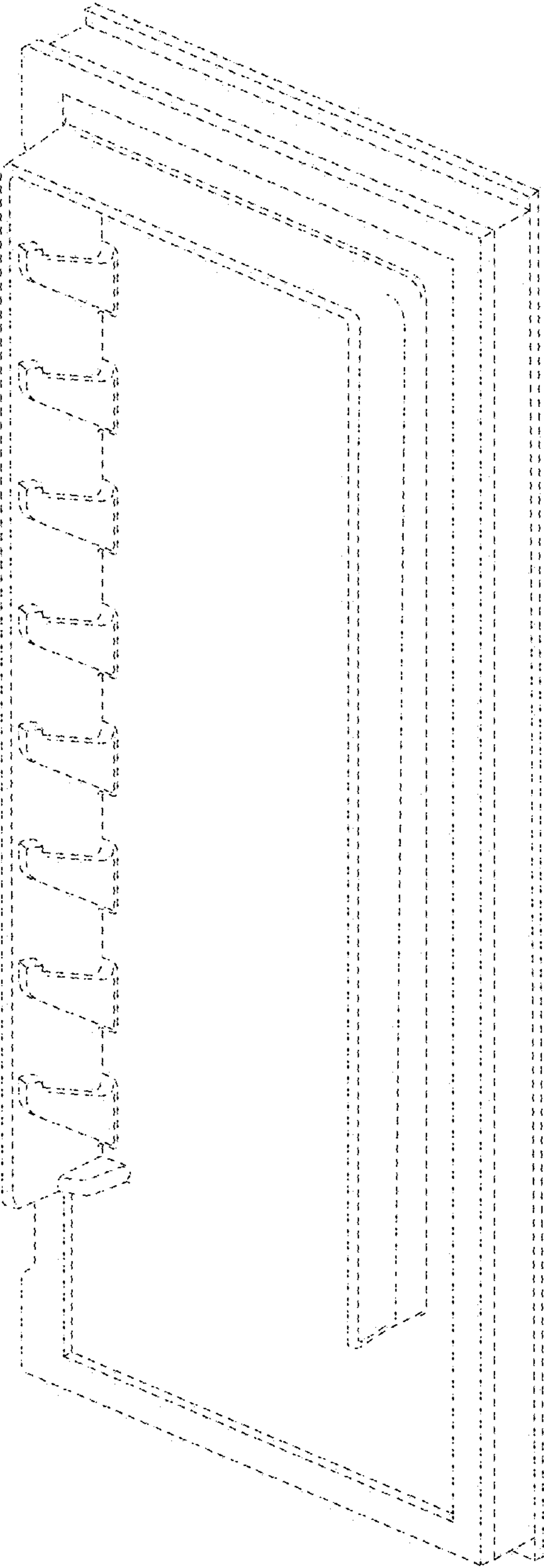

FIG. 27

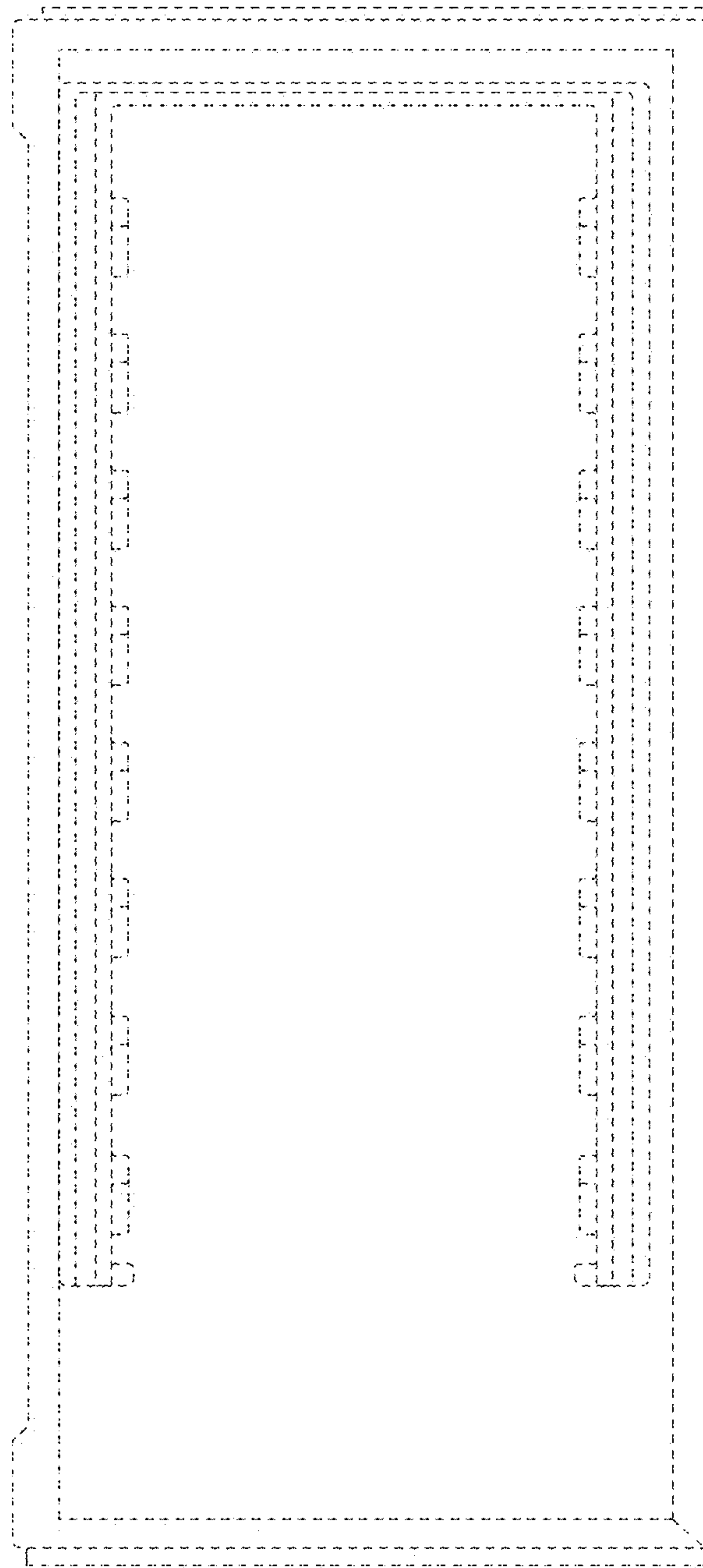

FIG. 28

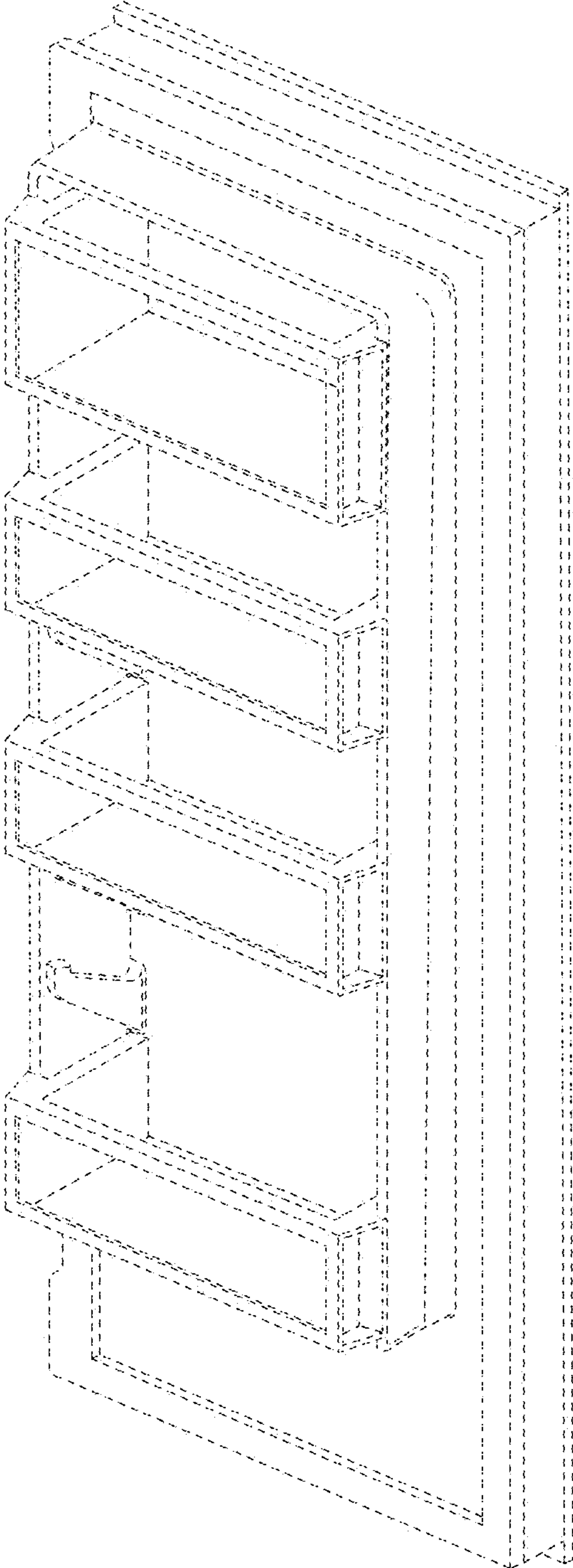

FIG. 29

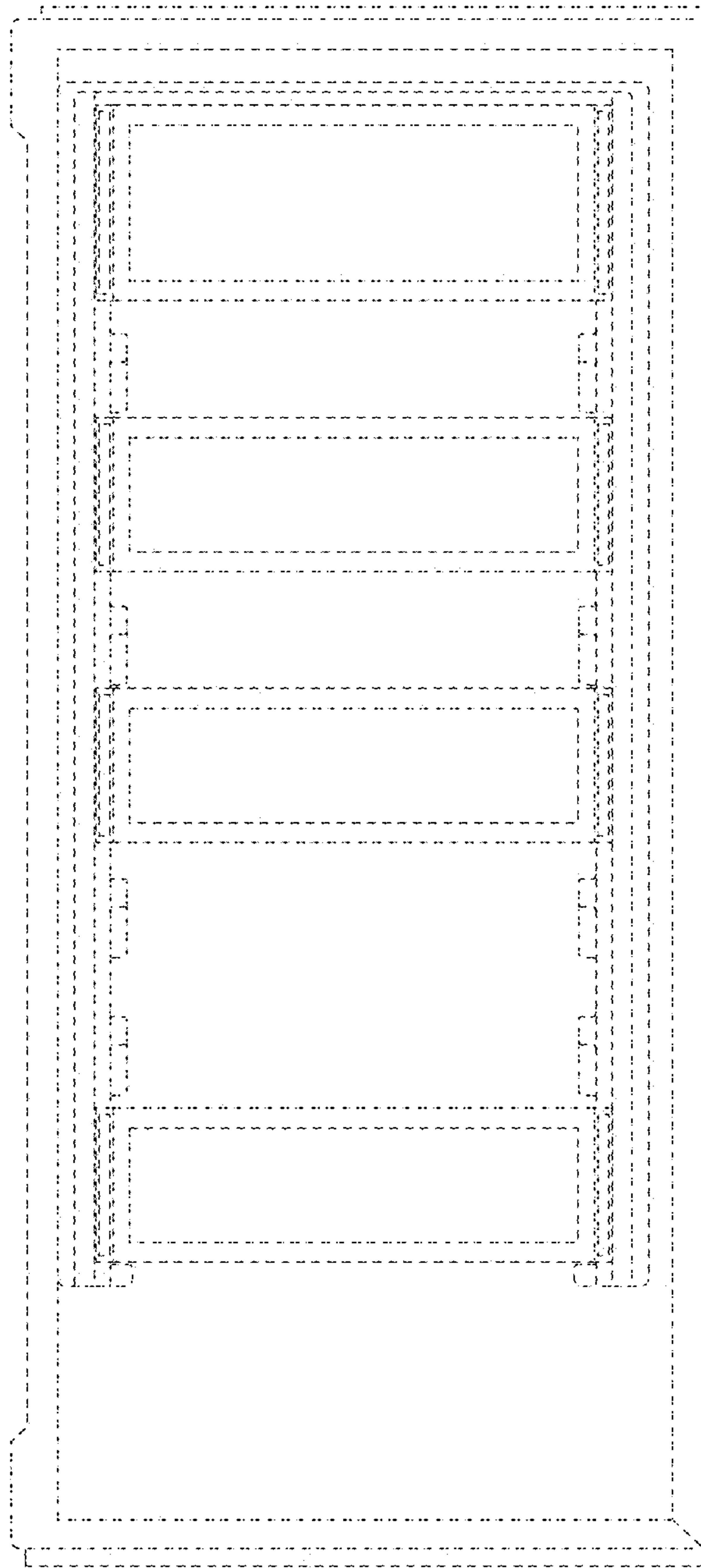

FIG. 30

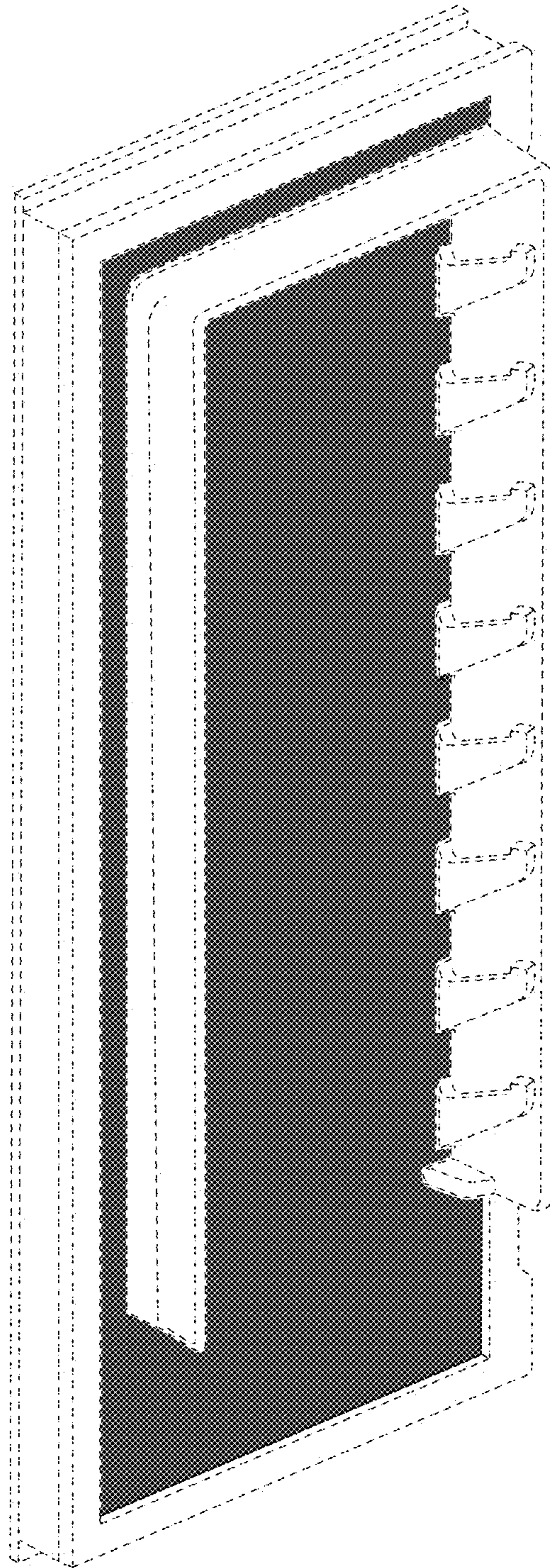

FIG. 31

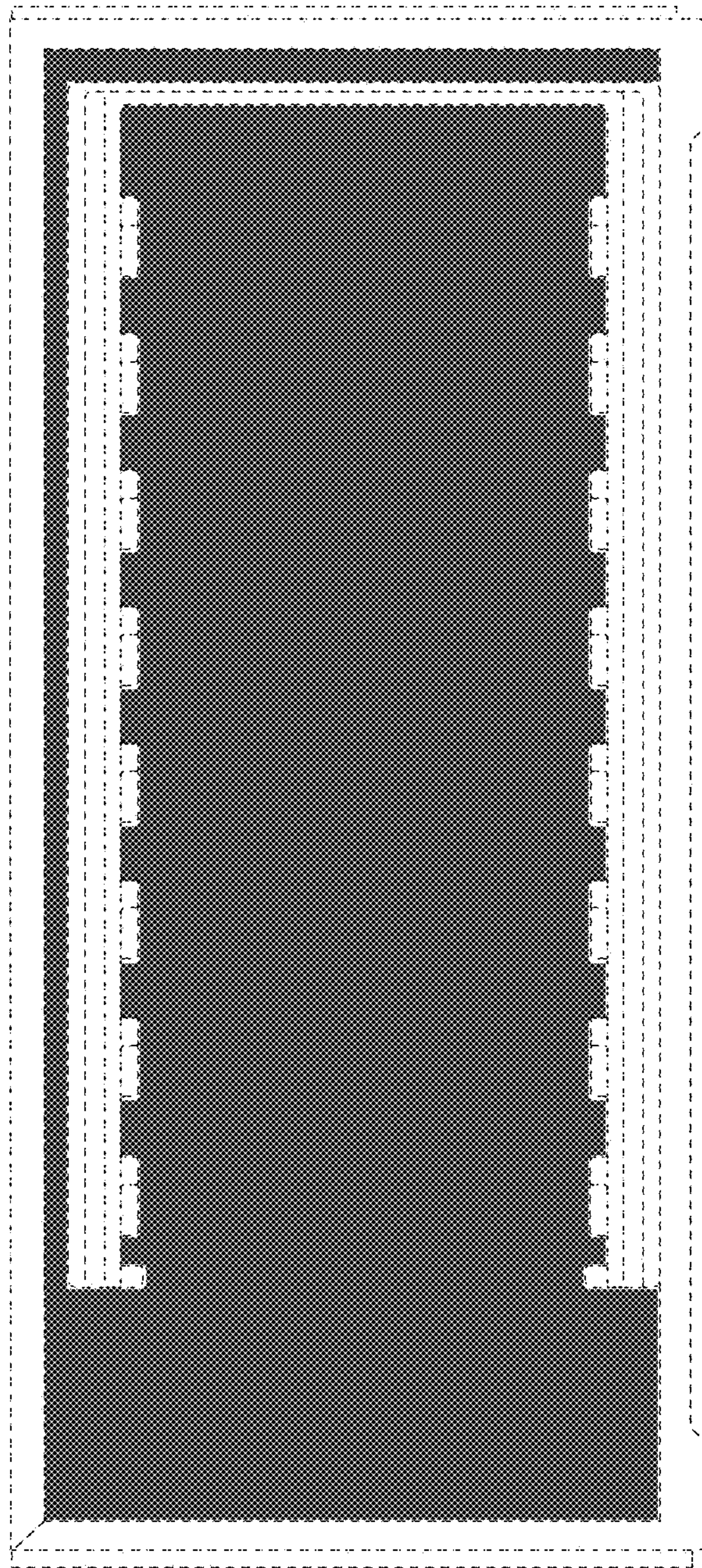

FIG. 32

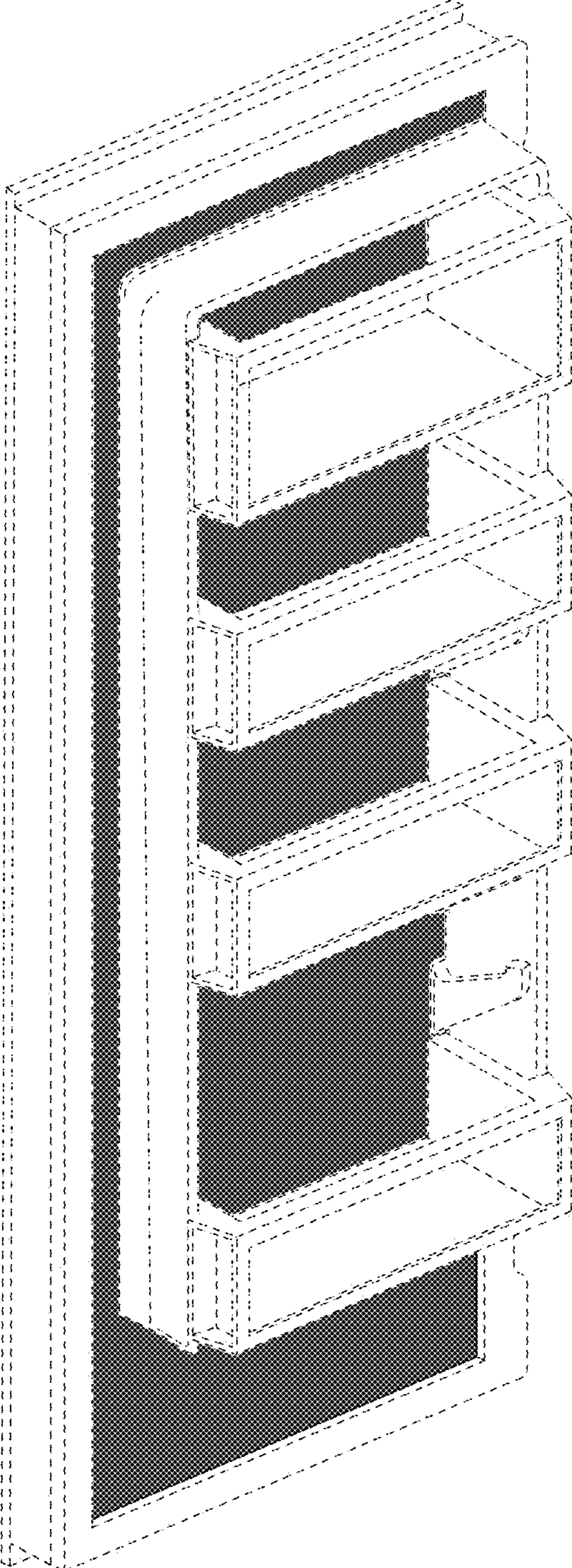

FIG. 33

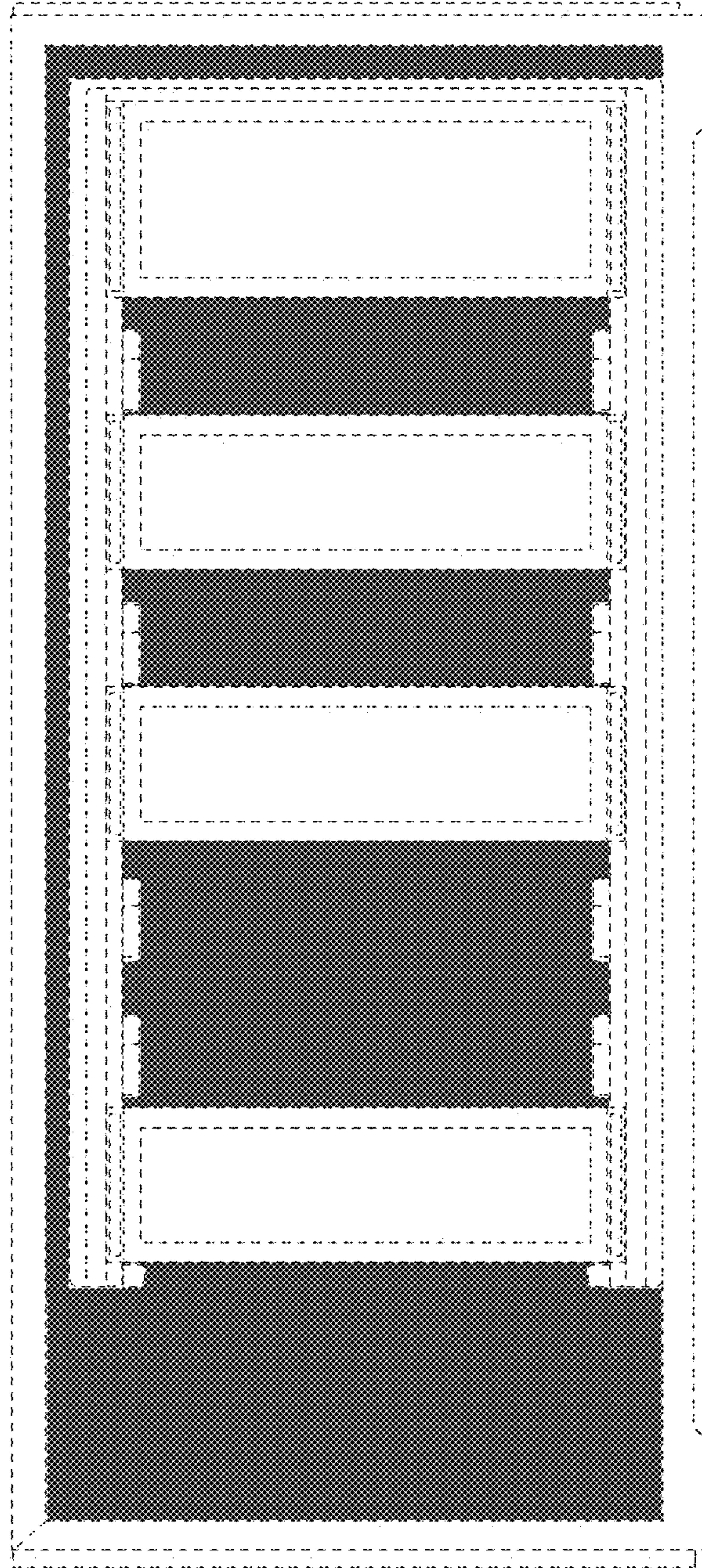

FIG. 34

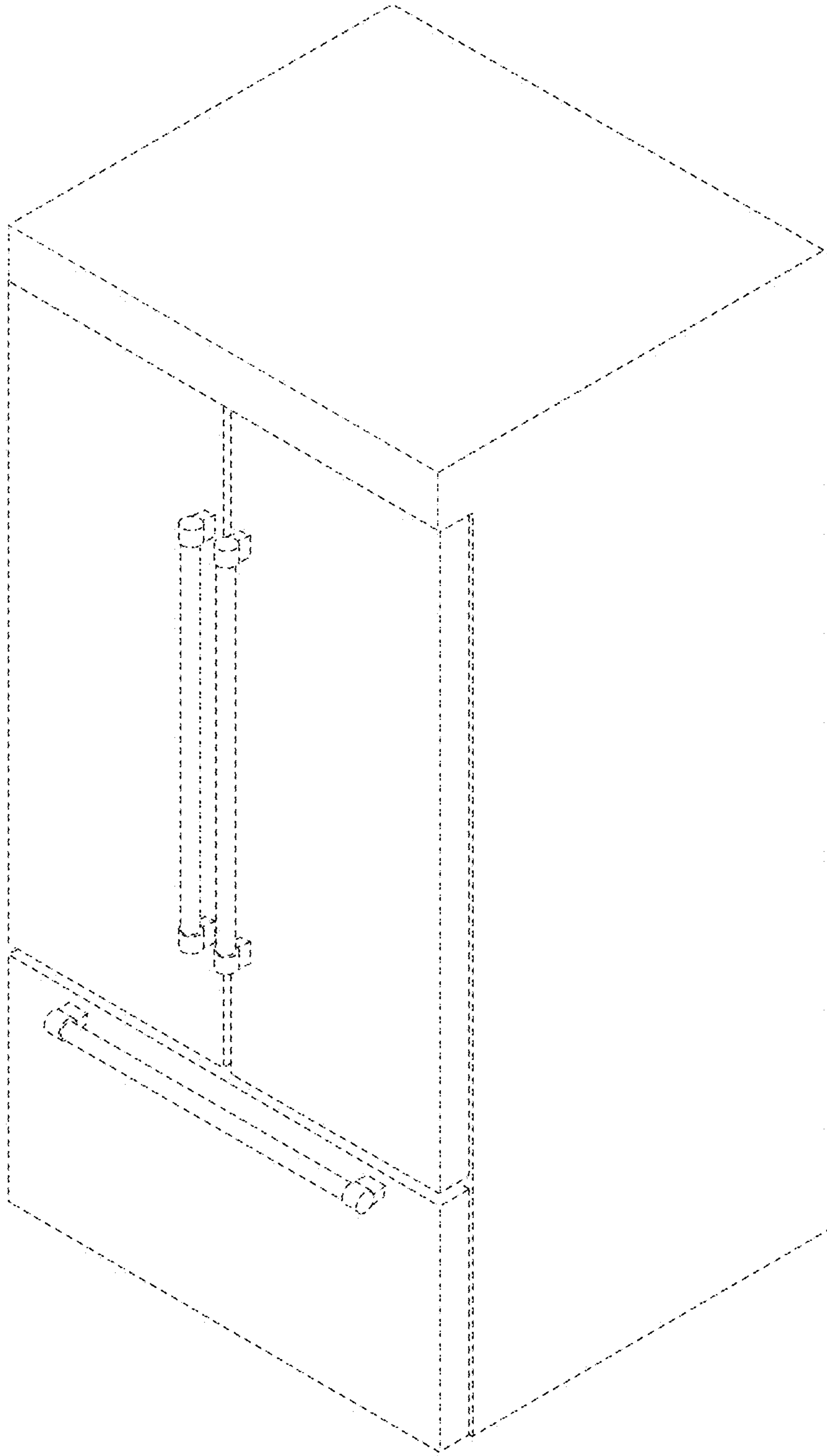

FIG. 35

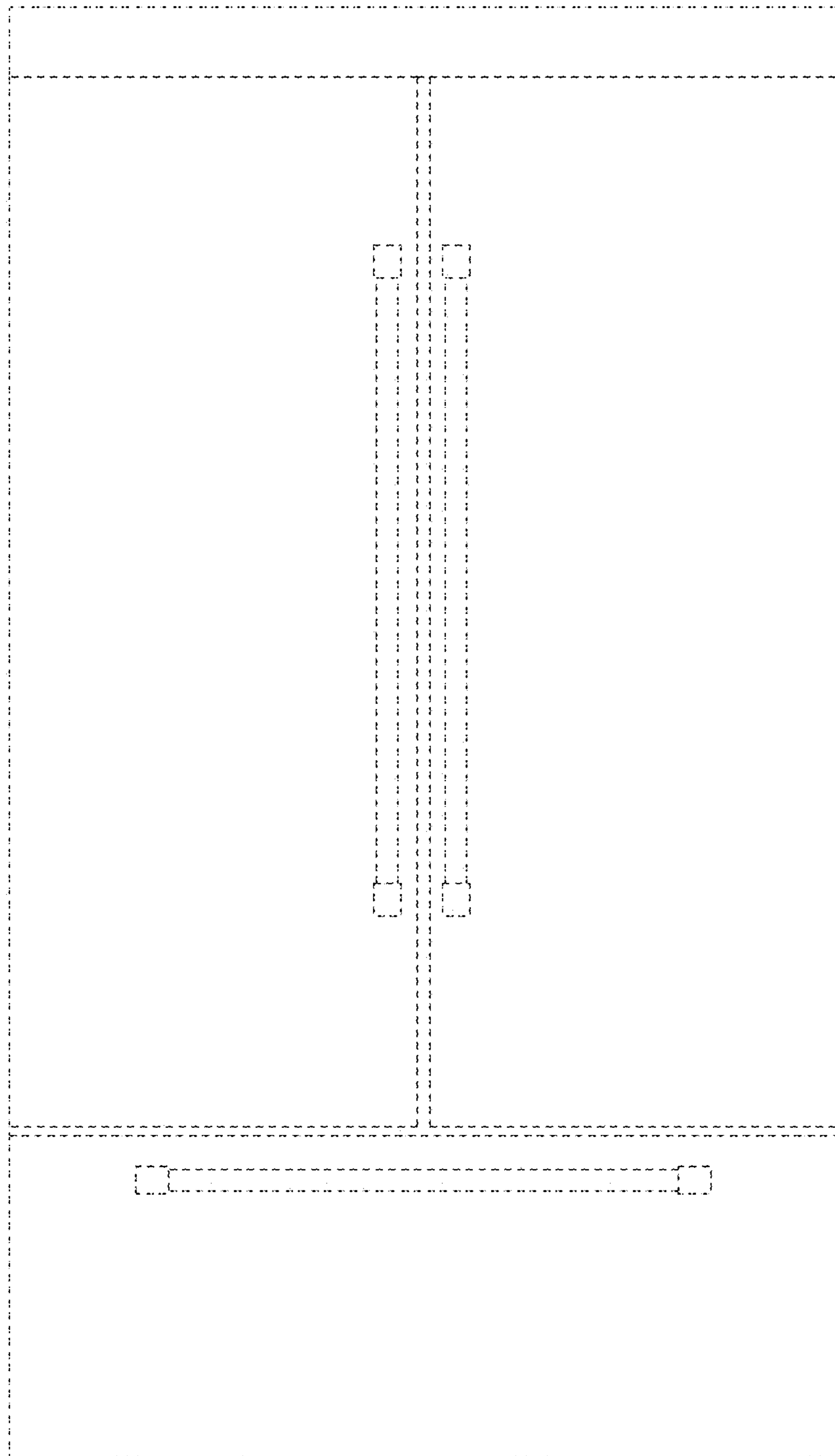

FIG. 36



FIG. 37

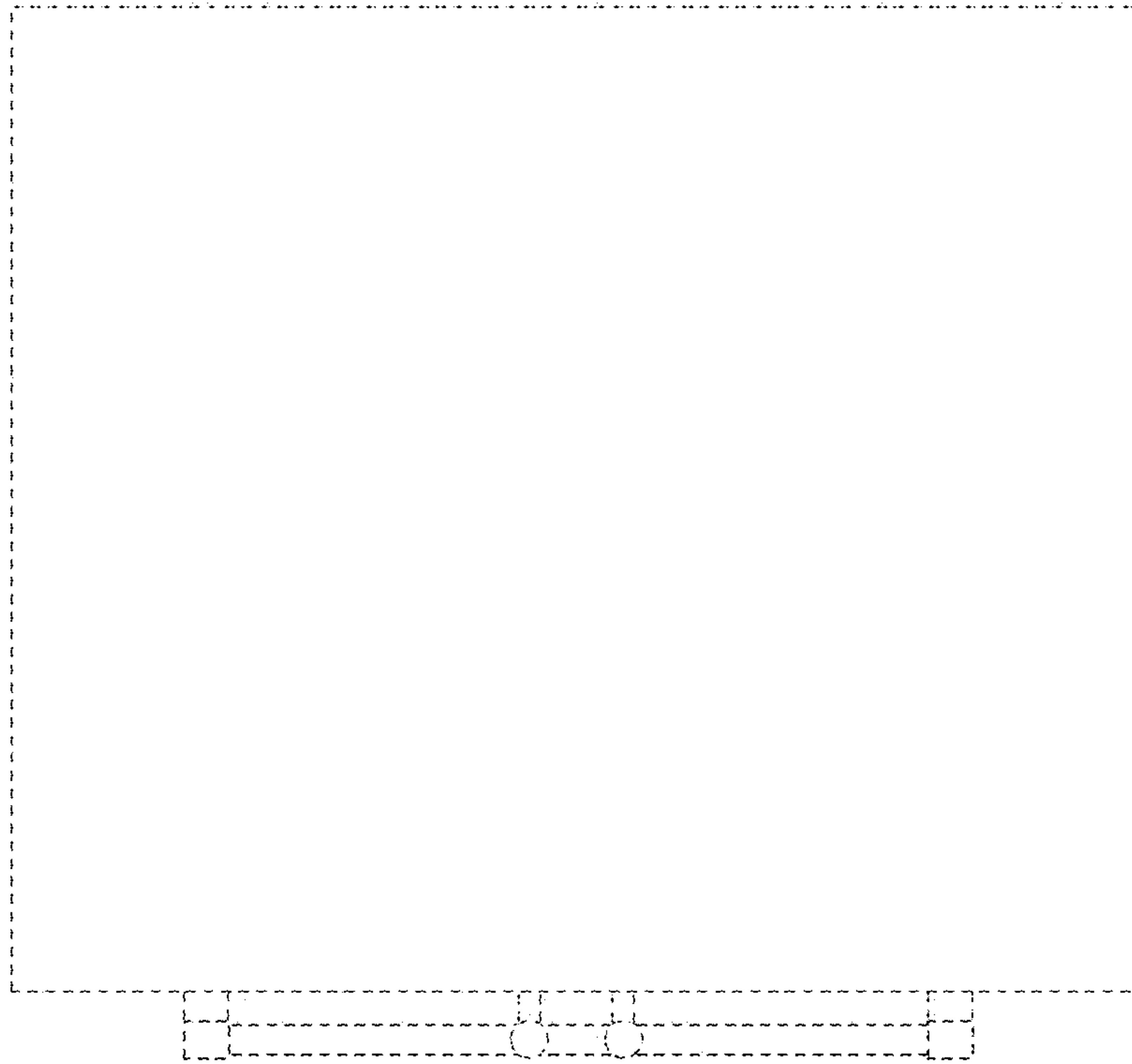

FIG. 38

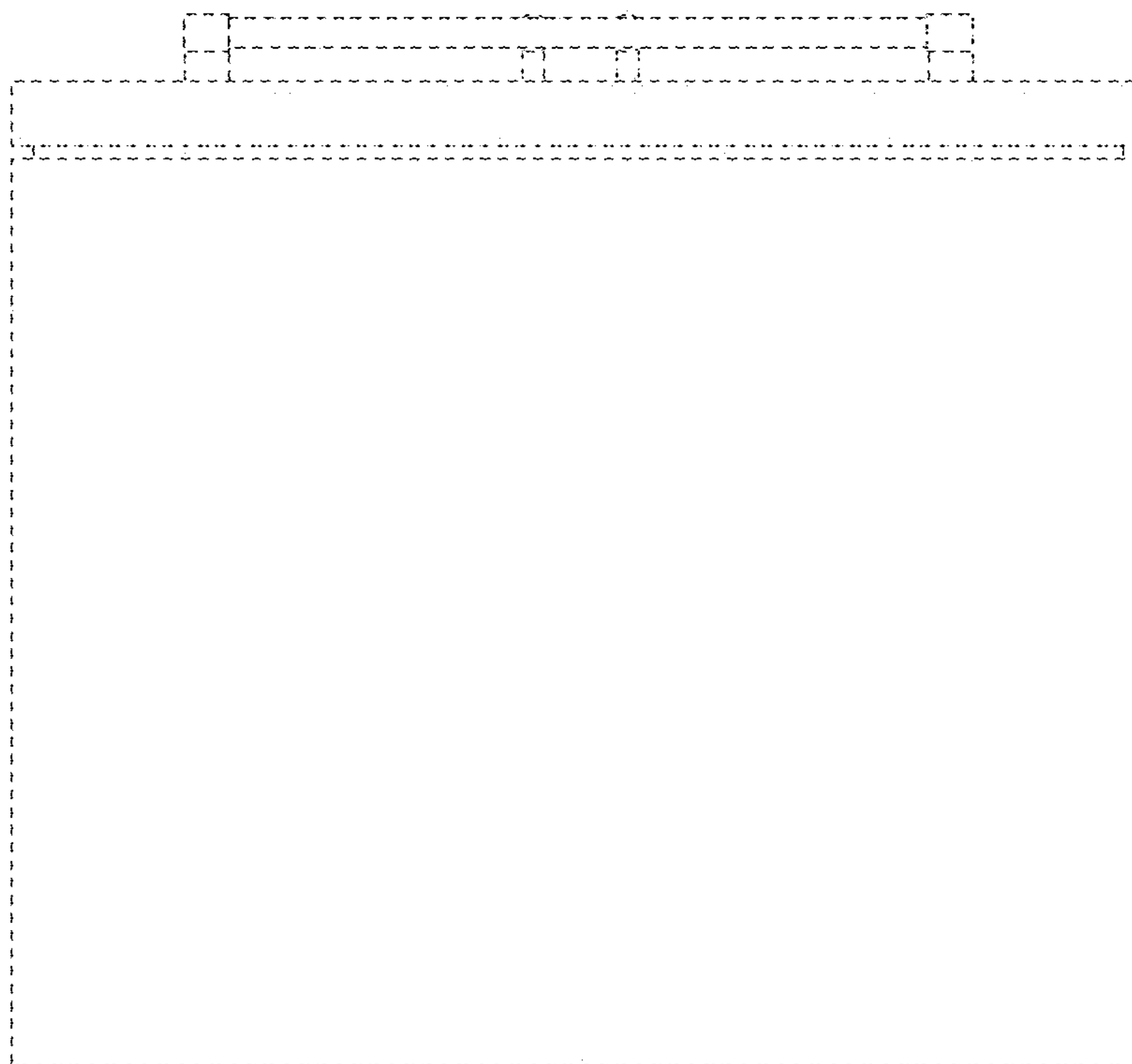

FIG. 39

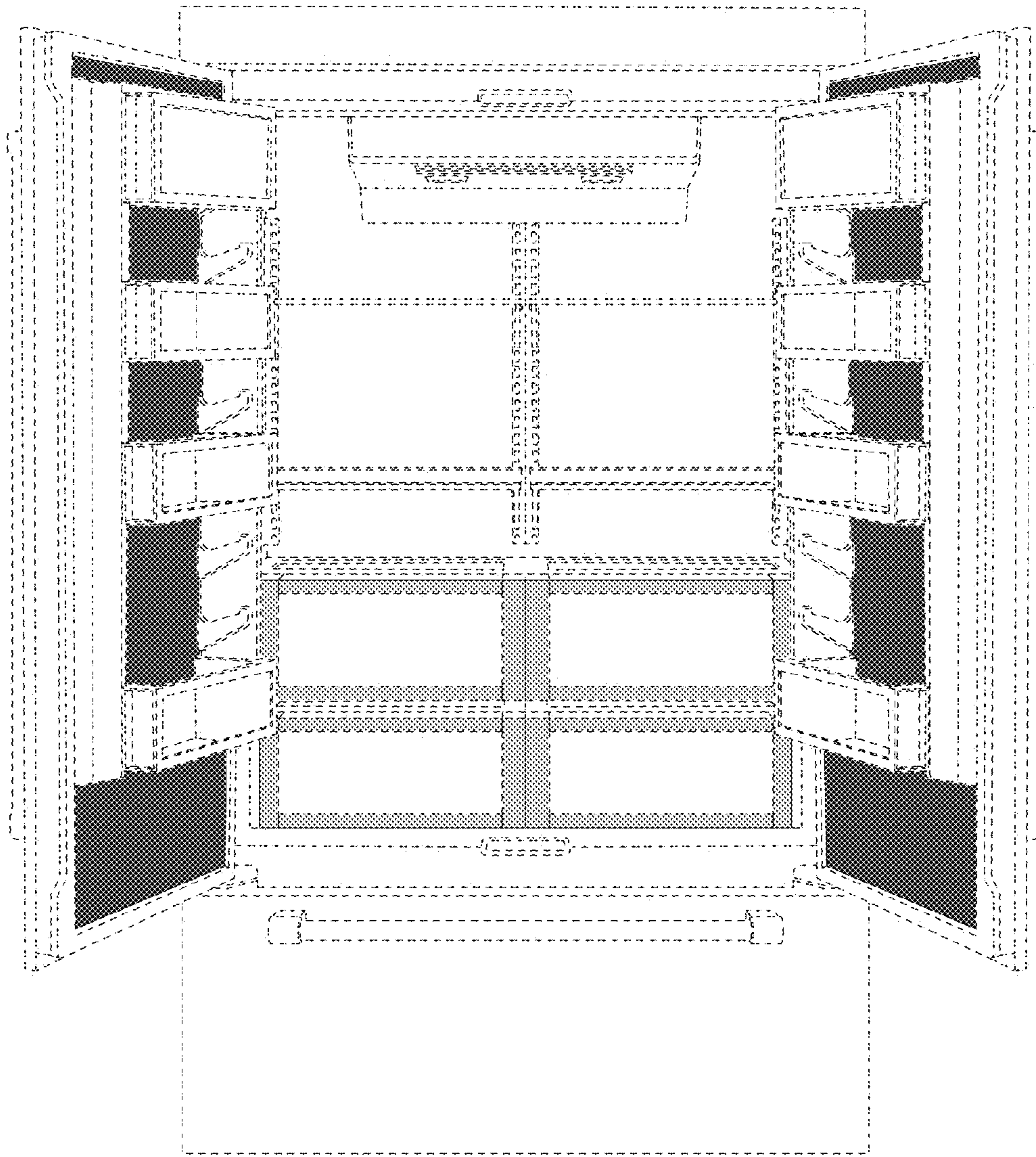
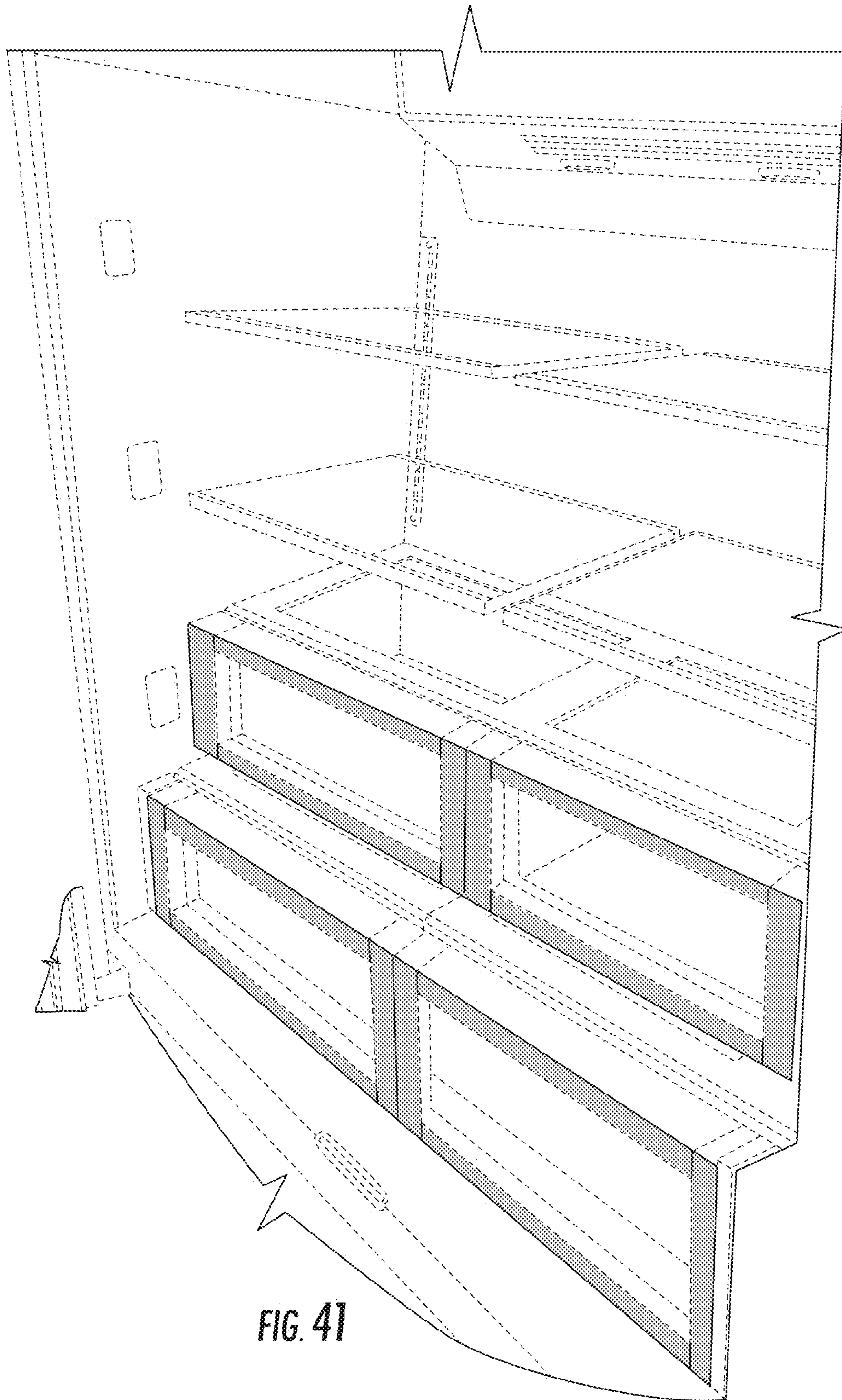
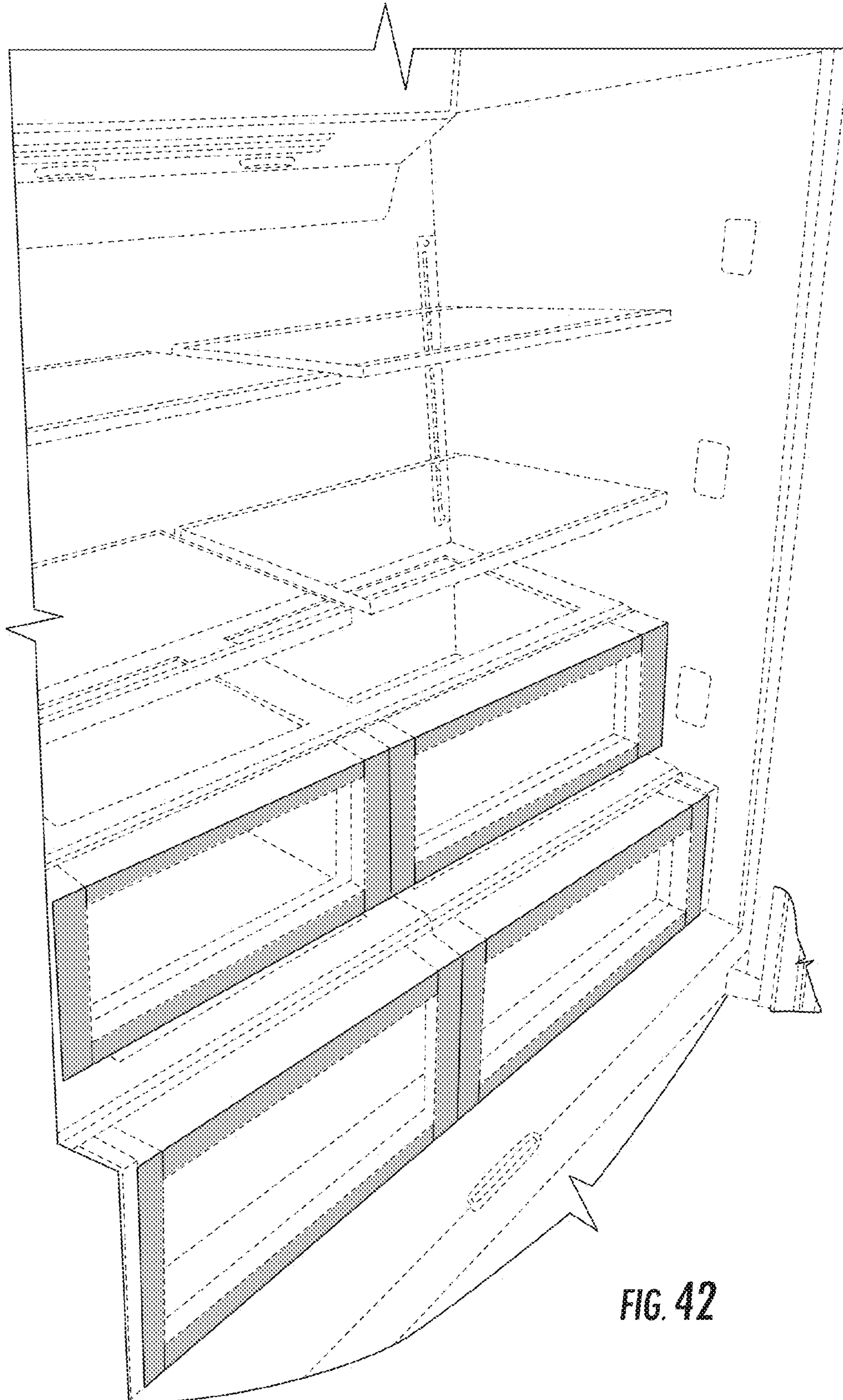

FIG. 40





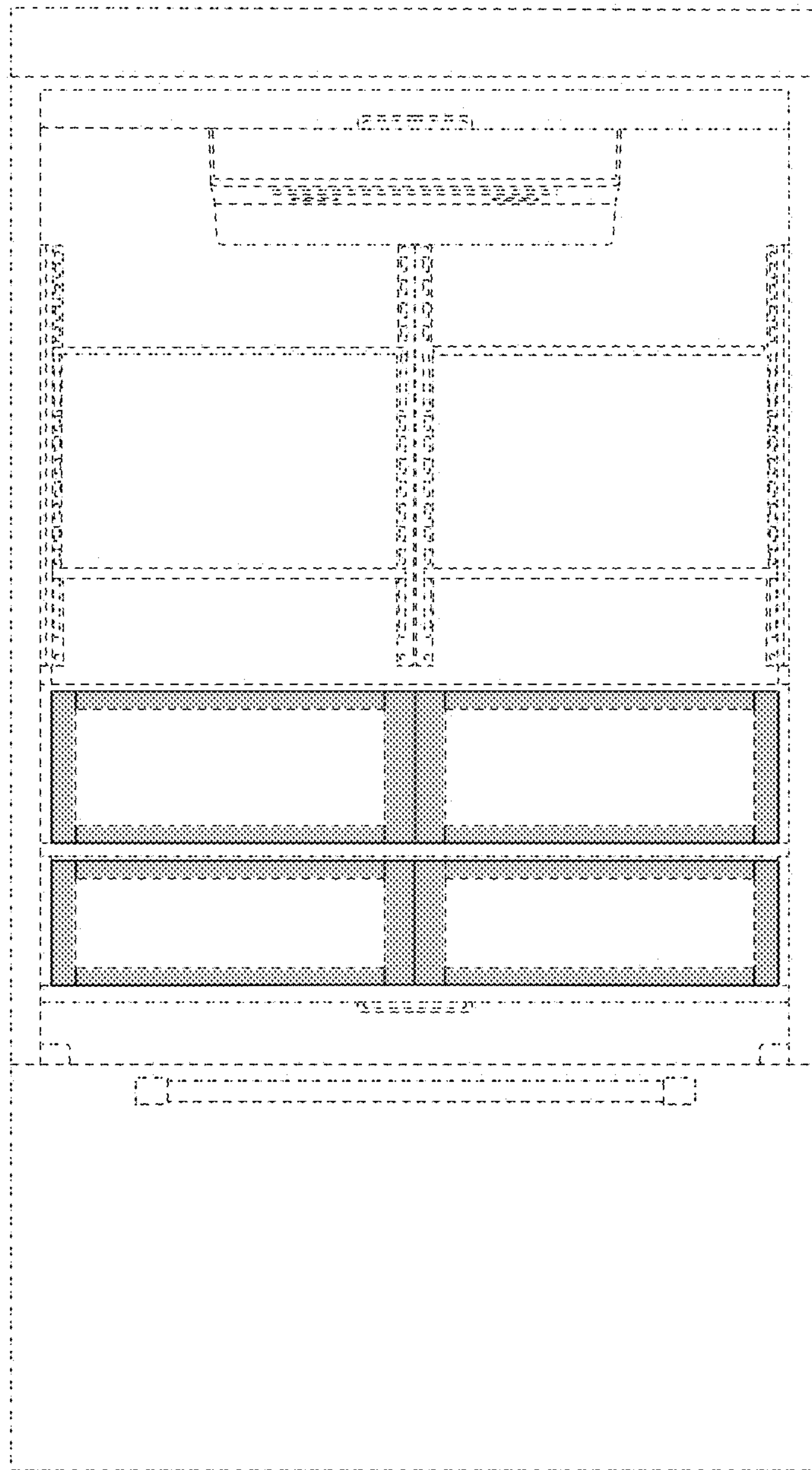

FIG. 43

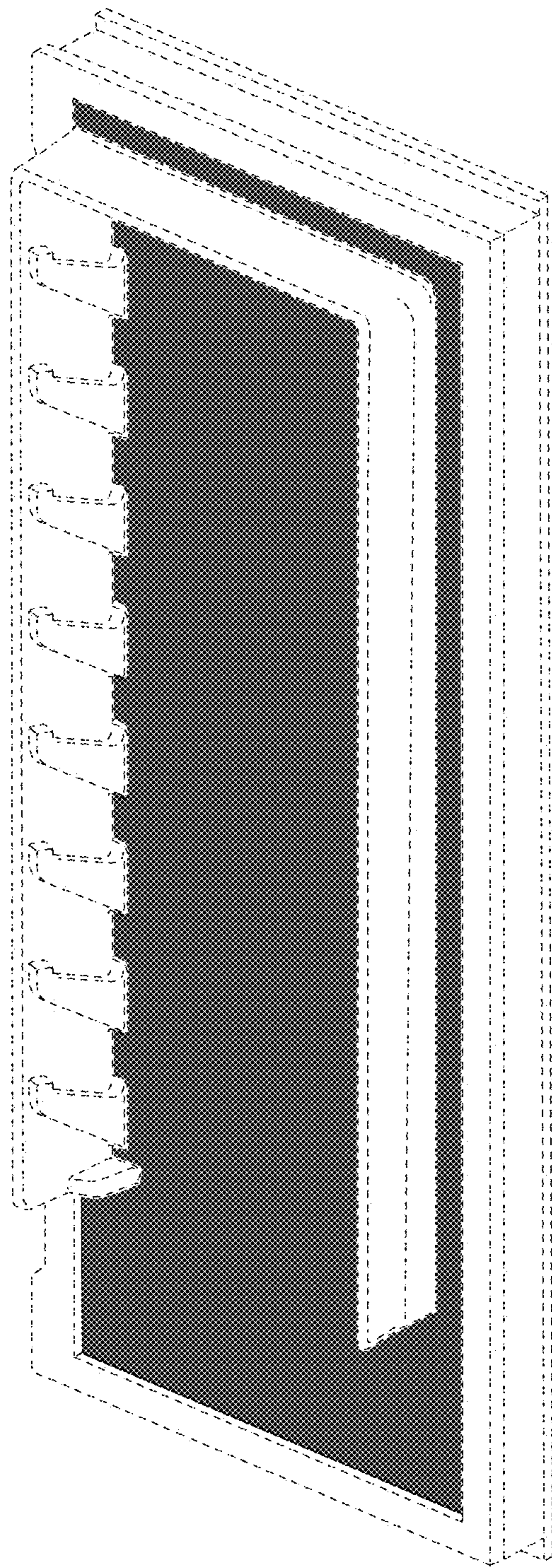

FIG. 44

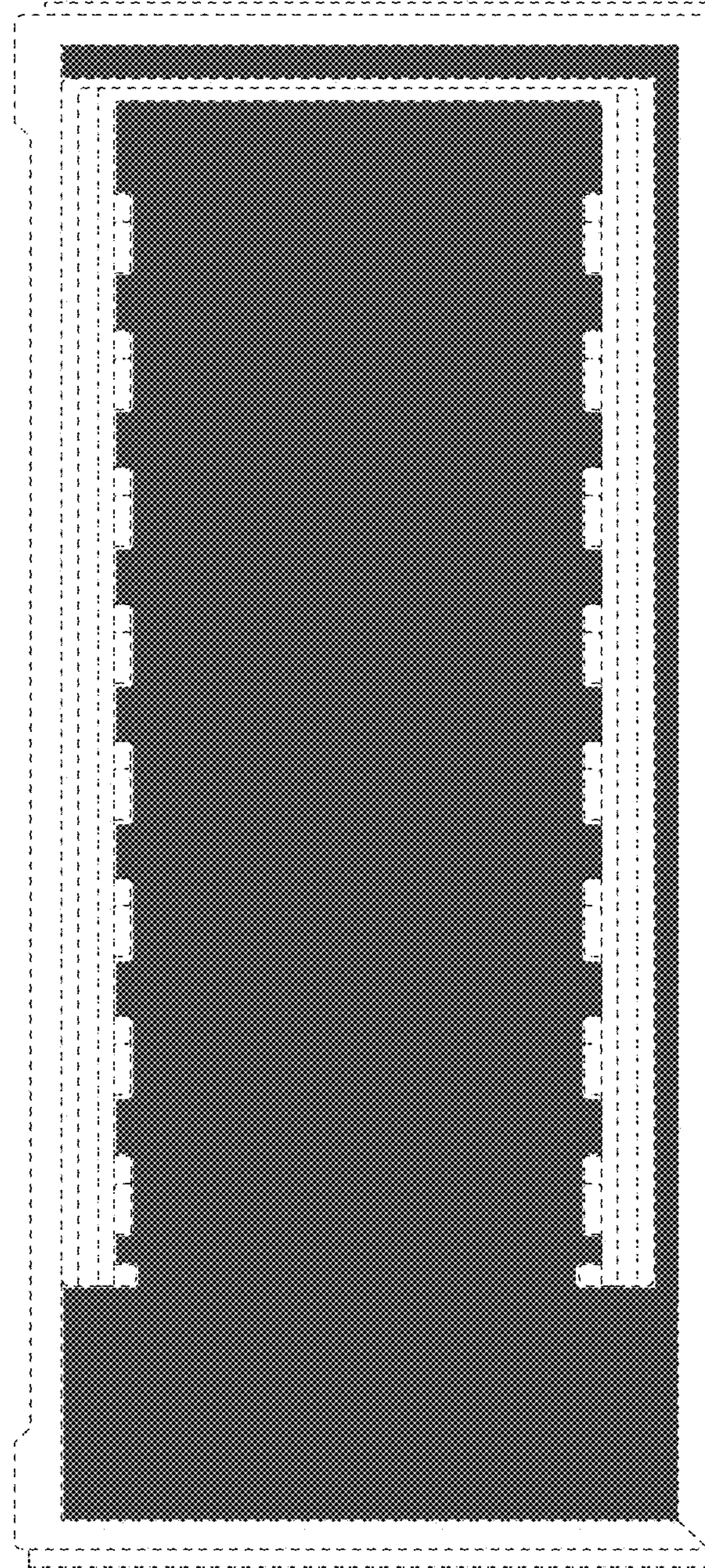

FIG. 45

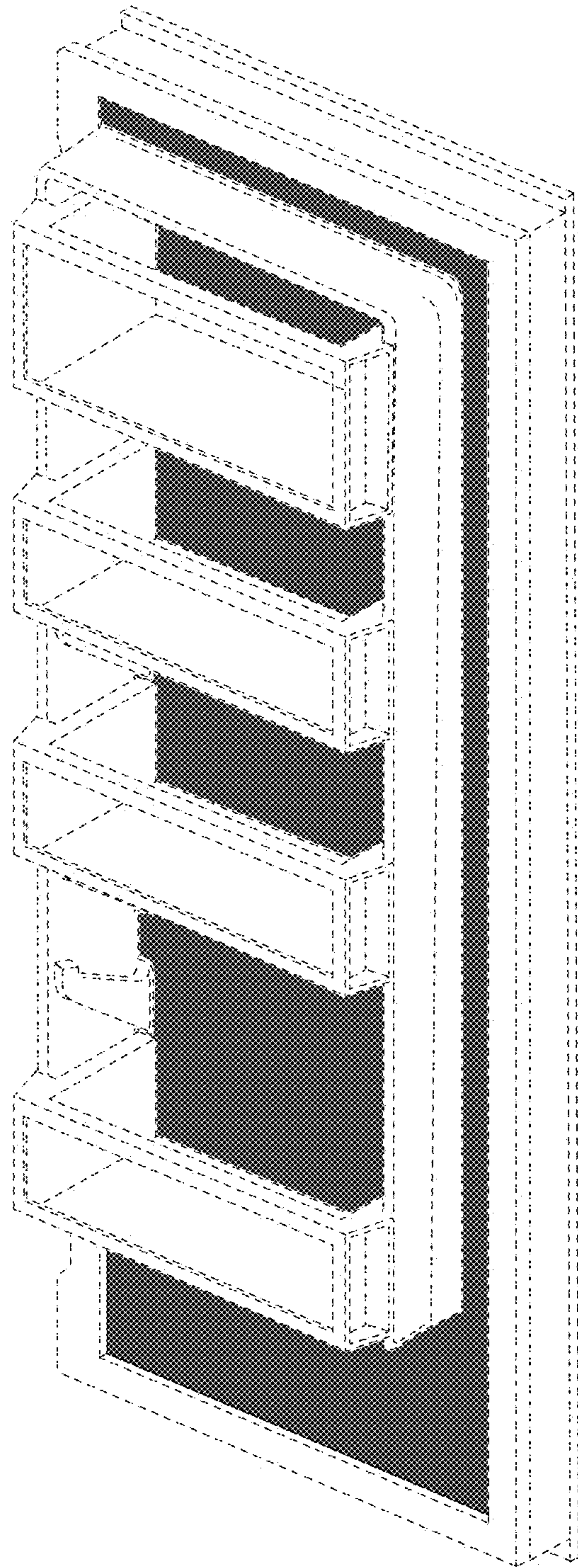

FIG. 46

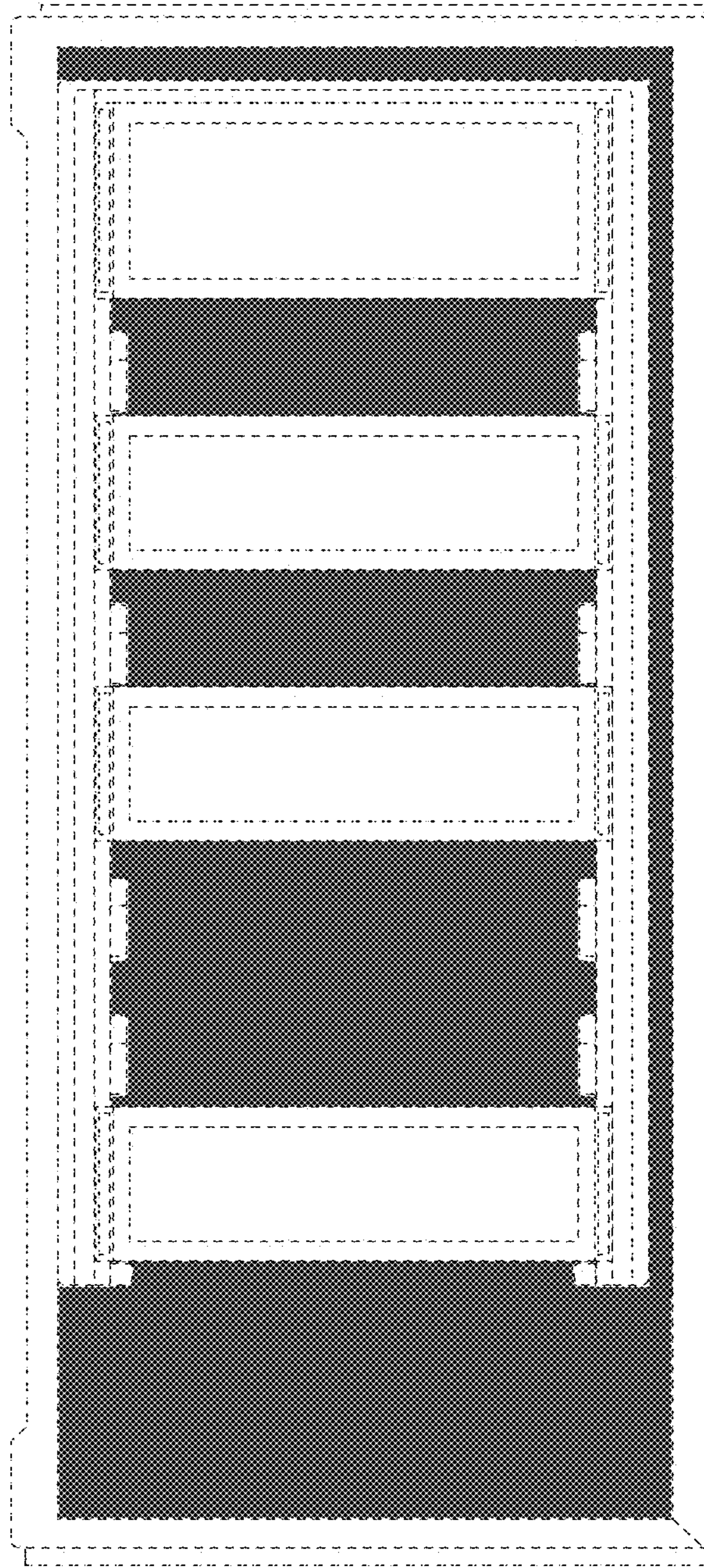

FIG. 47

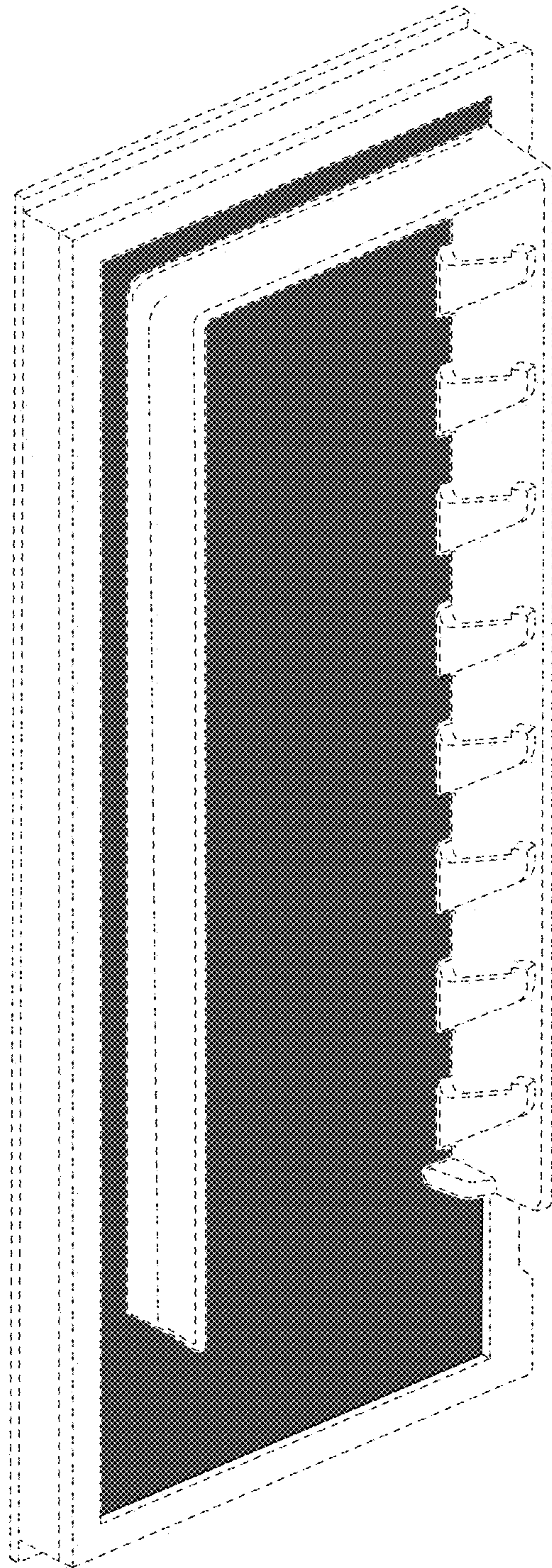

FIG. 48

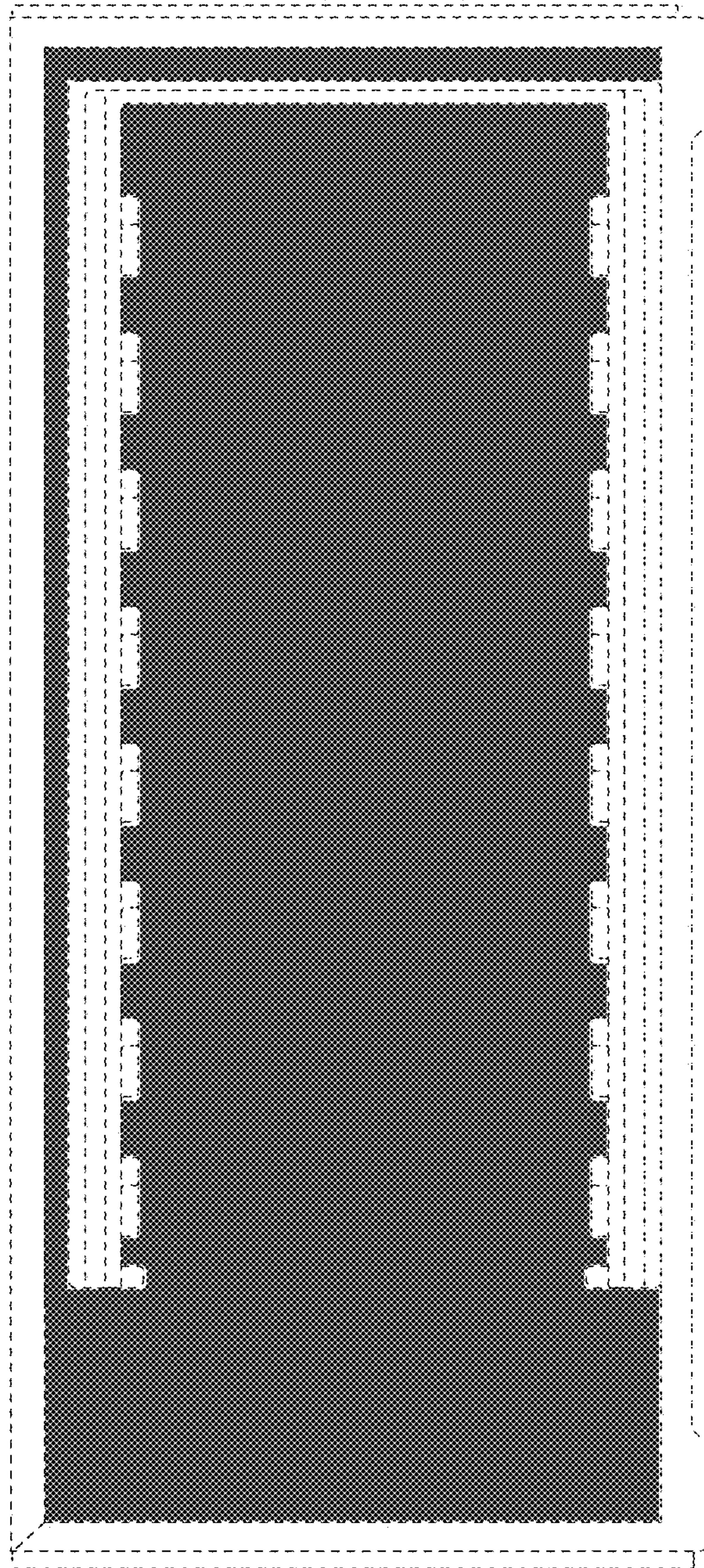

FIG. 49

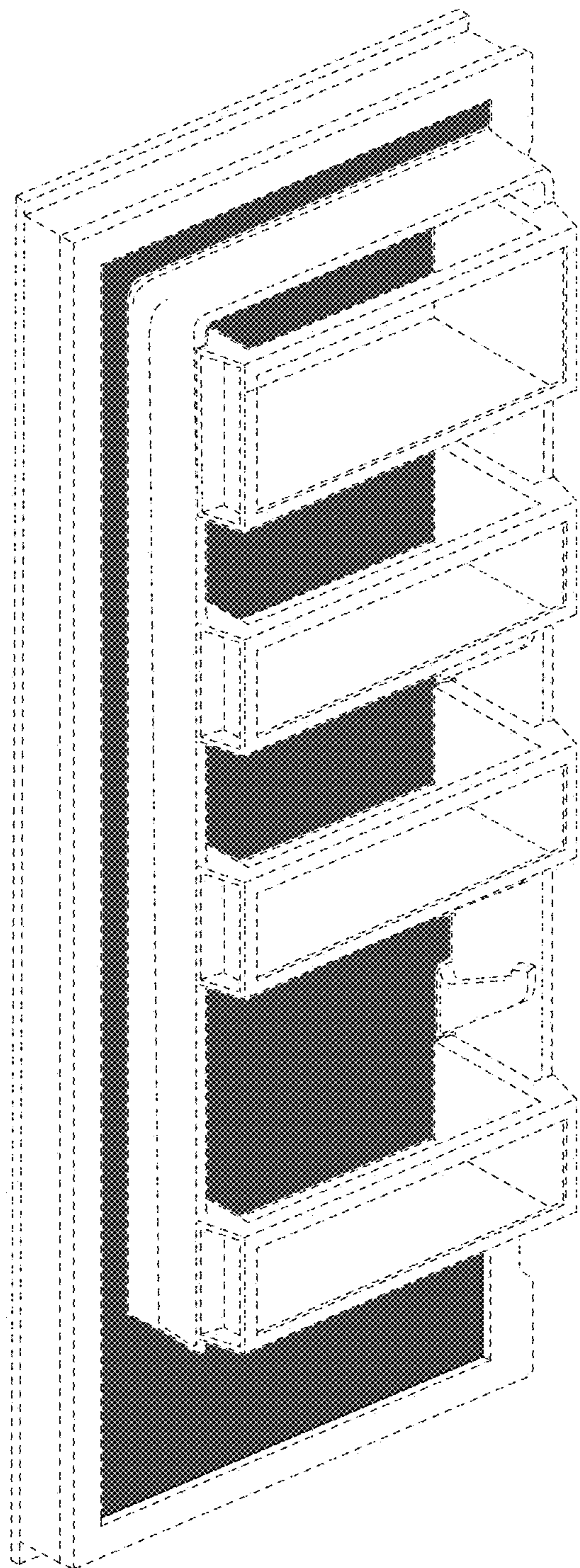

FIG. 50

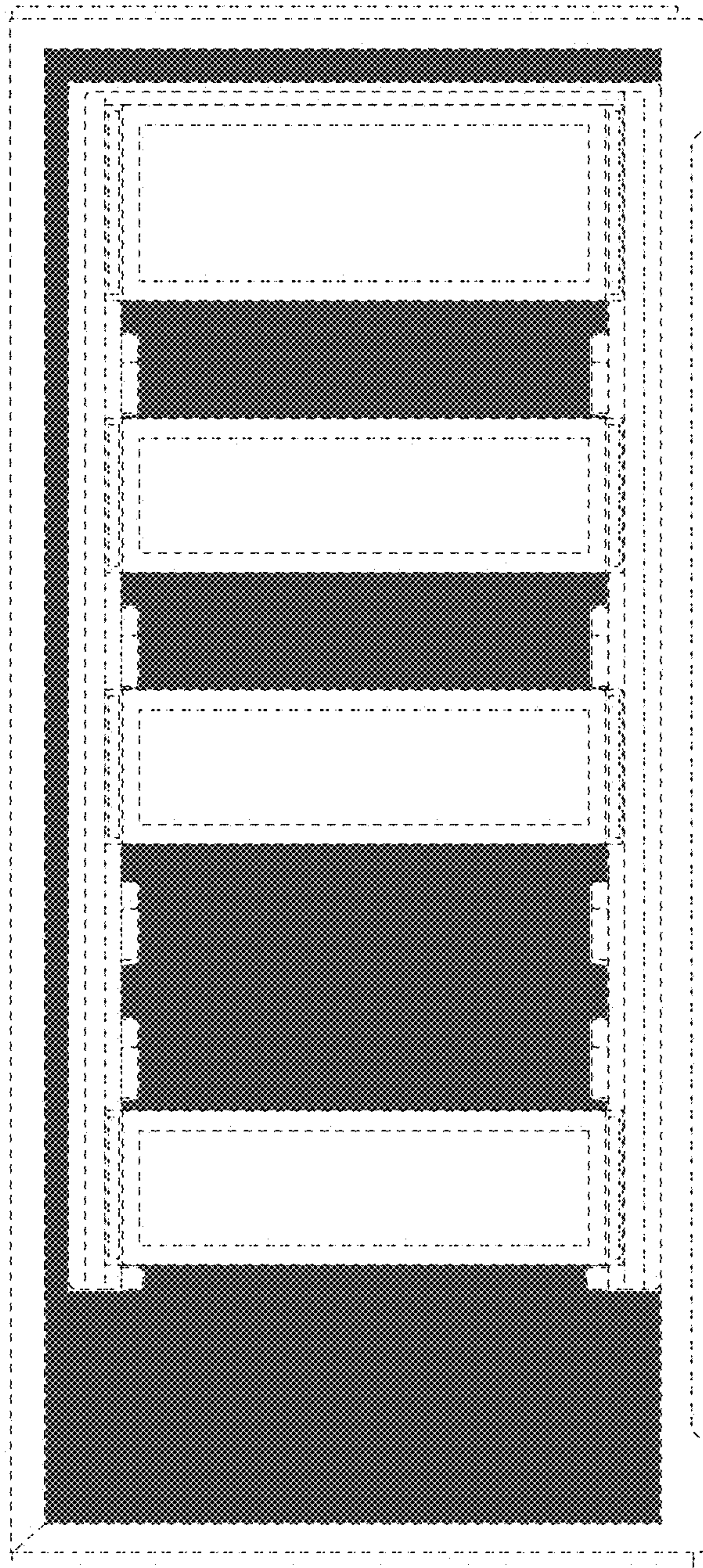

FIG. 51