



US00D748367S

(12) **United States Design Patent**
Haro et al.

(10) **Patent No.:** **US D748,367 S**
(45) **Date of Patent:** **** Feb. 2, 2016**

(54) **SHAPED FOOD PRODUCT**

(71) Applicant: **Kraft Foods Group Brands LLC**,
Northfield, IL (US)

(72) Inventors: **Guillermo Haro**, Skokie, IL (US);
Timothy S. Hansen, La Grange, IL (US)

(73) Assignee: **Kraft Foods Group Brands LLC**,
Northfield, IL (US)

(**) Term: **14 Years**

(21) Appl. No.: **29/512,218**

(22) Filed: **Dec. 17, 2014**

D280,948 S 10/1985 Smith
D324,601 S 3/1992 Meyers et al.
D378,326 S 3/1997 Goodner

(Continued)

OTHER PUBLICATIONS

Viking Helmet Cookie Cutter, <http://www.coppergifts.com/cookie-cutters/pc/Viking-Helmet-Cookie-Cutter-p5206.htm>, retrived Jun. 3, 2014, 2 pages.

Primary Examiner — Deanna L Pratt

Assistant Examiner — Katie Mroczka

(74) *Attorney, Agent, or Firm* — Foley & Lardner LLP

(57) **CLAIM**

We claim the ornamental design for a shaped food product, as shown and described.

DESCRIPTION

FIG. 1 is a front perspective view of one embodiment of the claimed design;

FIG. 2 is a front view of the design of FIG. 1;

FIG. 3 is a rear view of the design of FIG. 1;

FIG. 4 is a top view of the design of FIG. 1;

FIG. 5 is a bottom view of the design of FIG. 1;

FIG. 6 is a left side view of the design of FIG. 1;

FIG. 7 is a right side view of the design of FIG. 1;

FIG. 8 is a front perspective view of another embodiment of the claimed design;

FIG. 9 is a front view of the design of FIG. 8;

FIG. 10 is a rear view of the design of FIG. 8;

FIG. 11 is a top view of the design of FIG. 8;

FIG. 12 is a bottom view of the design of FIG. 8;

FIG. 13 is a left side view of the design of FIG. 8; and,

FIG. 14 is a right side view of the design of FIG. 8.

Related U.S. Application Data

(62) Division of application No. 29/473,143, filed on Nov. 19, 2013, now Pat. No. Des. 720,117.

(51) **LOC (10) Cl.** **01-01**

(52) **U.S. Cl.**

USPC **D1/126; D1/107**

(58) **Field of Classification Search**

USPC D1/100–130, 199; D7/335, 556, 359,
D7/672, 675, 676, 677; D2/869, 871, 872,
D2/889, 895; D29/103, 122; D11/14, 30,
D11/44, 48, 81, 239; D6/320; D9/668

See application file for complete search history.

(56) **References Cited**

U.S. PATENT DOCUMENTS

D179,967 S 4/1957 Erickson
D277,996 S 3/1985 Megargee

1 Claim, 12 Drawing Sheets

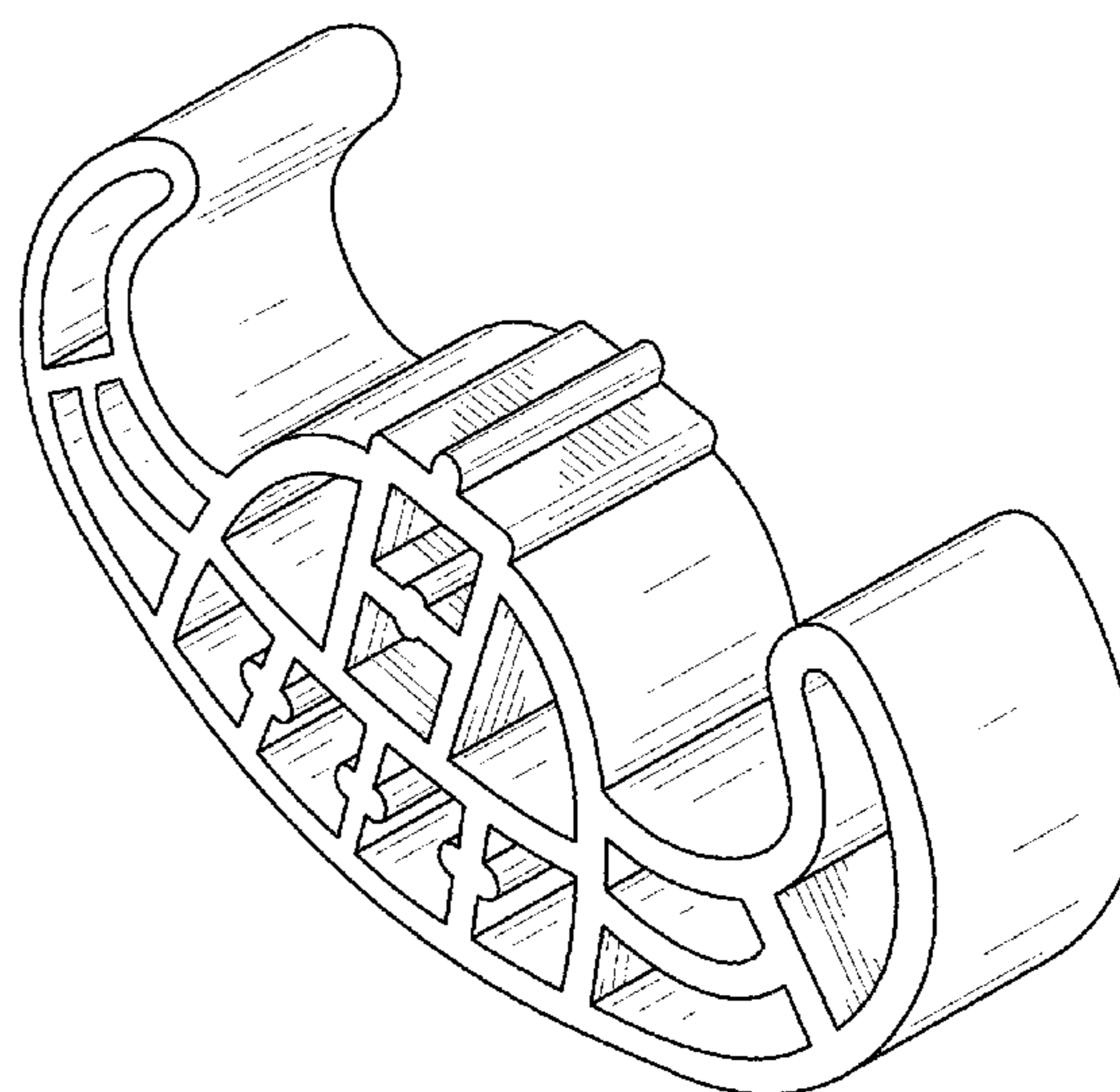
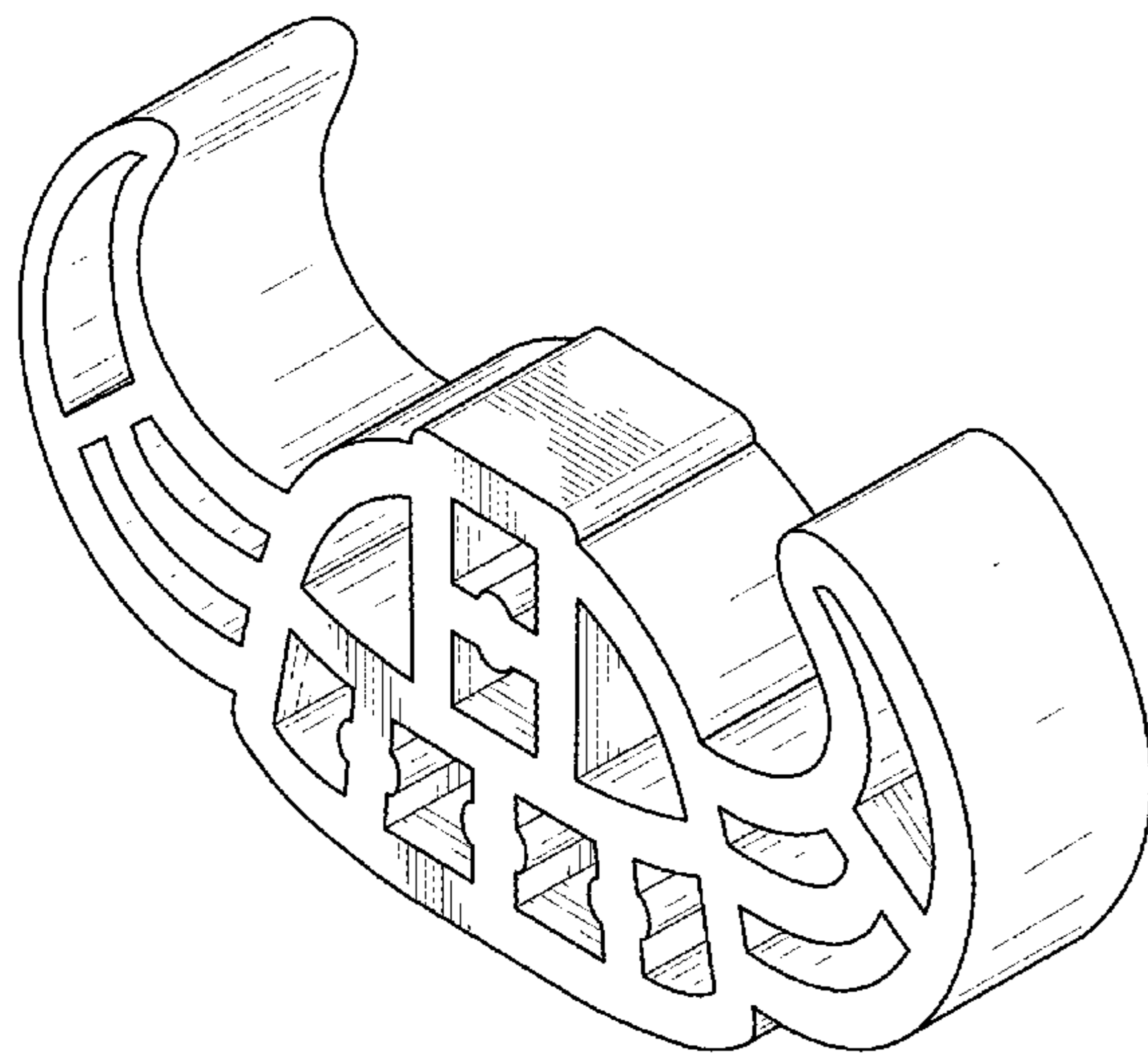

(56)

References Cited

U.S. PATENT DOCUMENTS

D396,940 S 8/1998 Clegg
D404,891 S 2/1999 Clegg
D414,591 S 10/1999 Baker
D458,735 S 6/2002 Cook et al.
D497,236 S 10/2004 Haro

D512,807 S 12/2005 Haro
D513,551 S 1/2006 Haro
D513,552 S * 1/2006 Haro D1/126
D525,411 S 7/2006 Haro
D574,576 S 8/2008 Greenleaf
D589,226 S 3/2009 Haro et al.
D596,832 S 7/2009 Kelley
D621,126 S 8/2010 Haro et al.

* cited by examiner

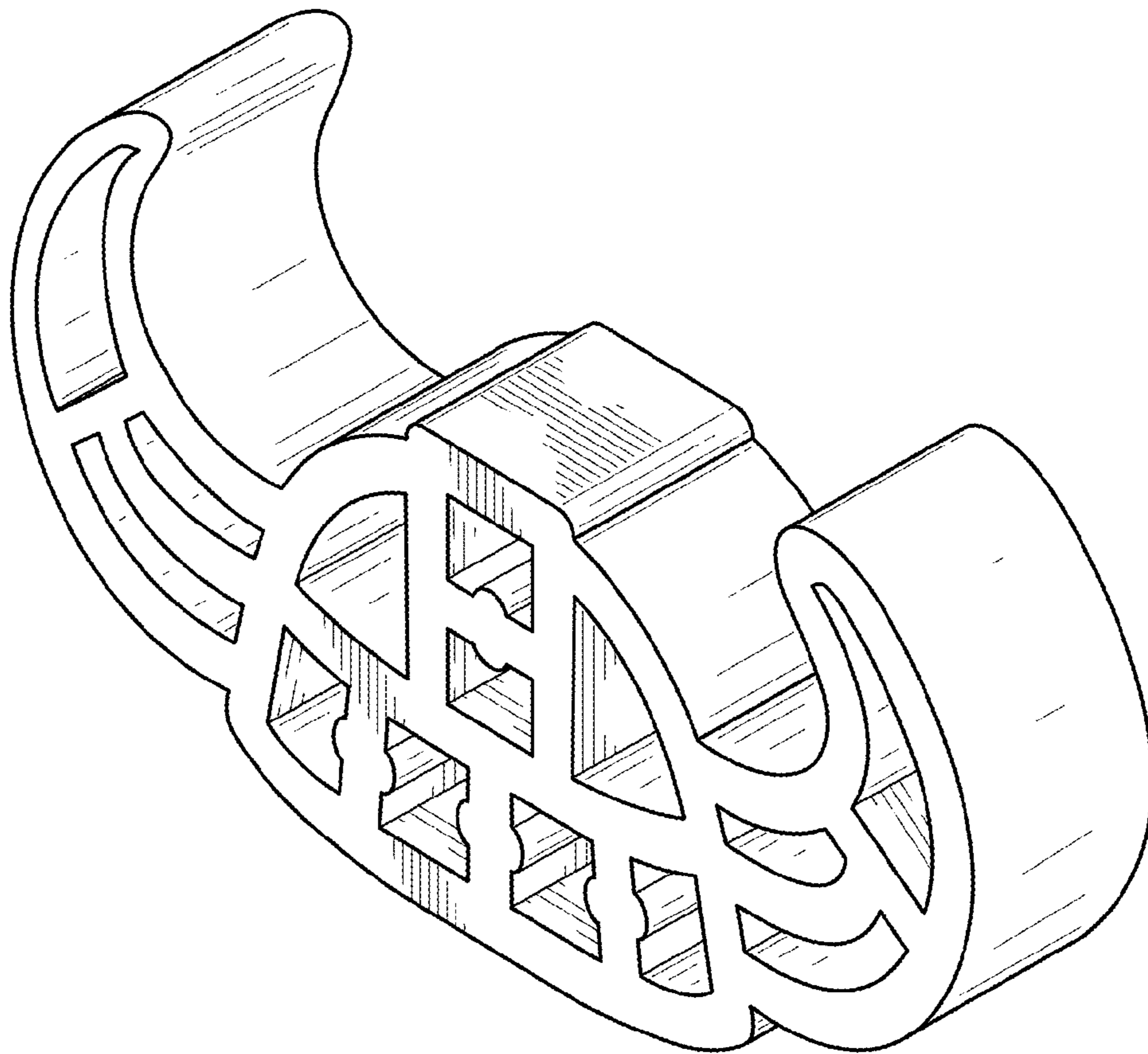

FIG. 1

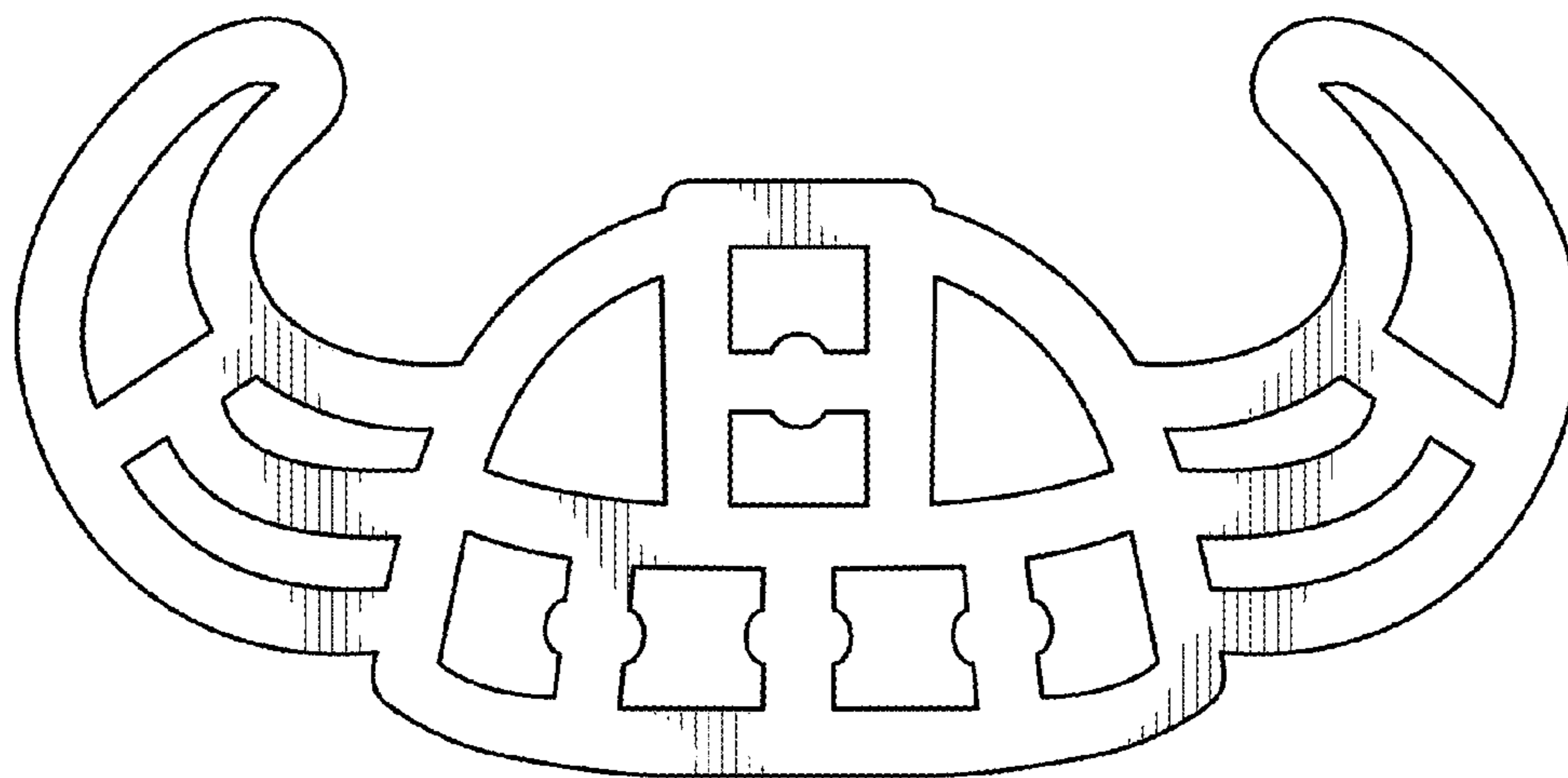

FIG. 2

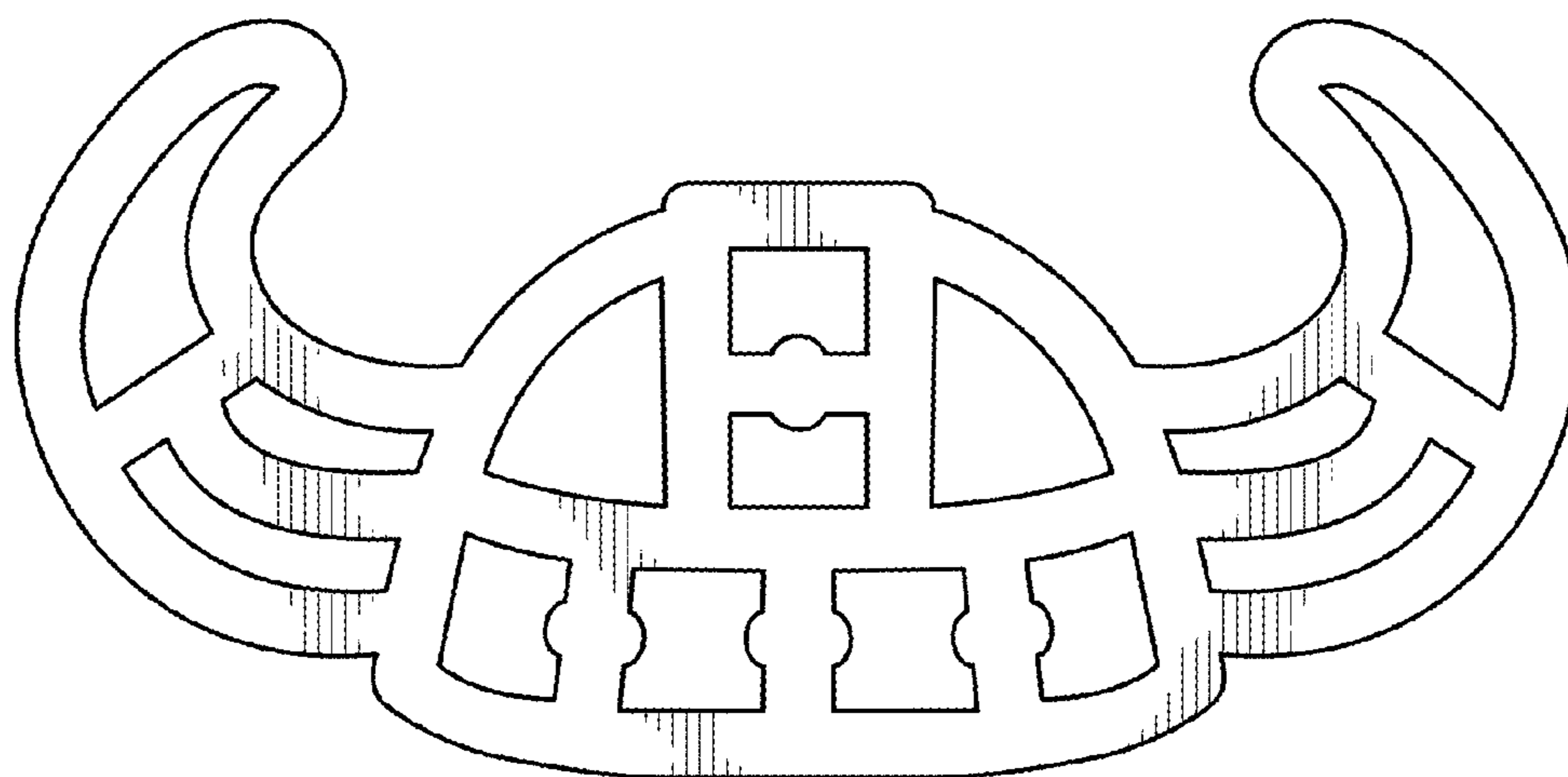

FIG. 3

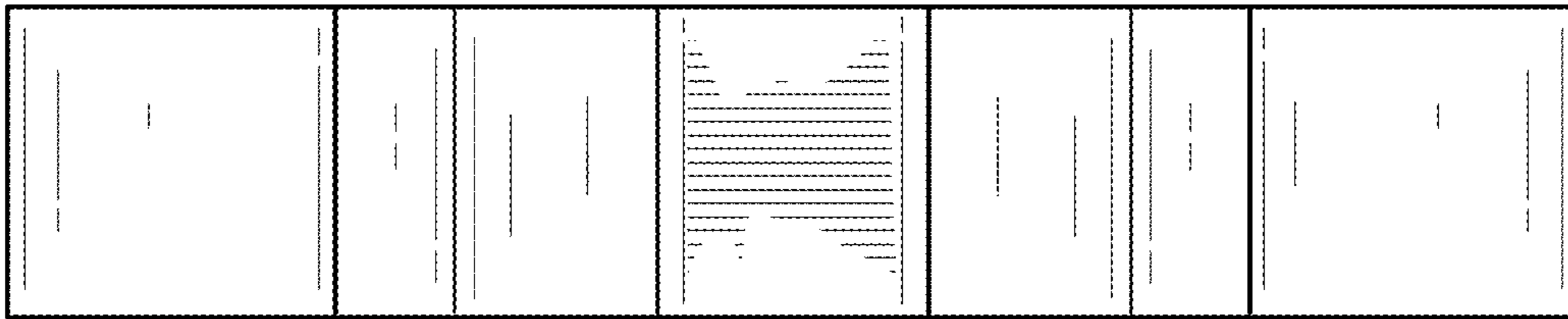

FIG. 4

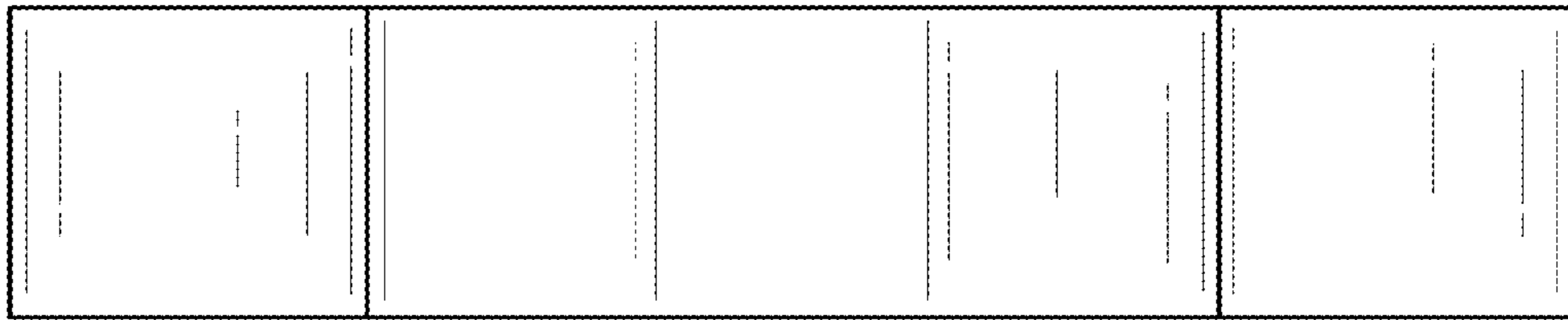

FIG. 5

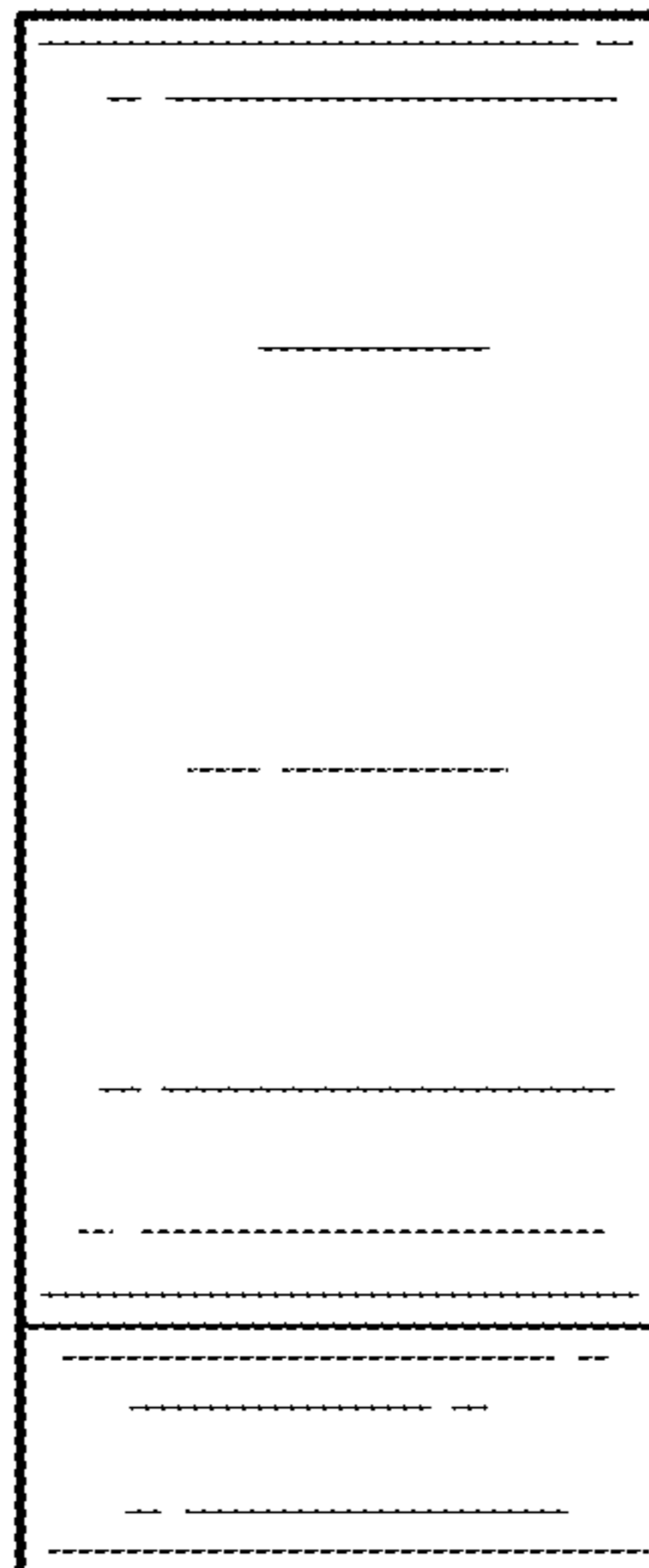

FIG. 6

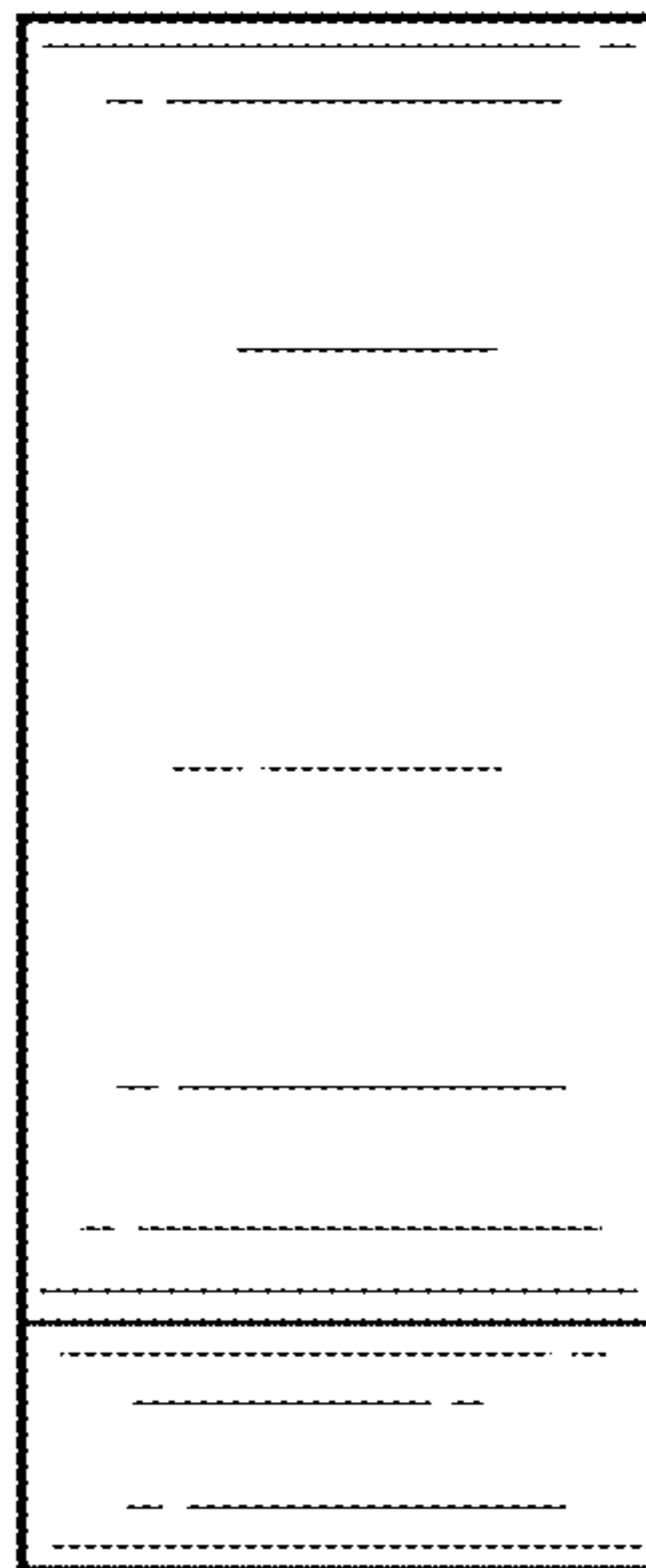

FIG. 7

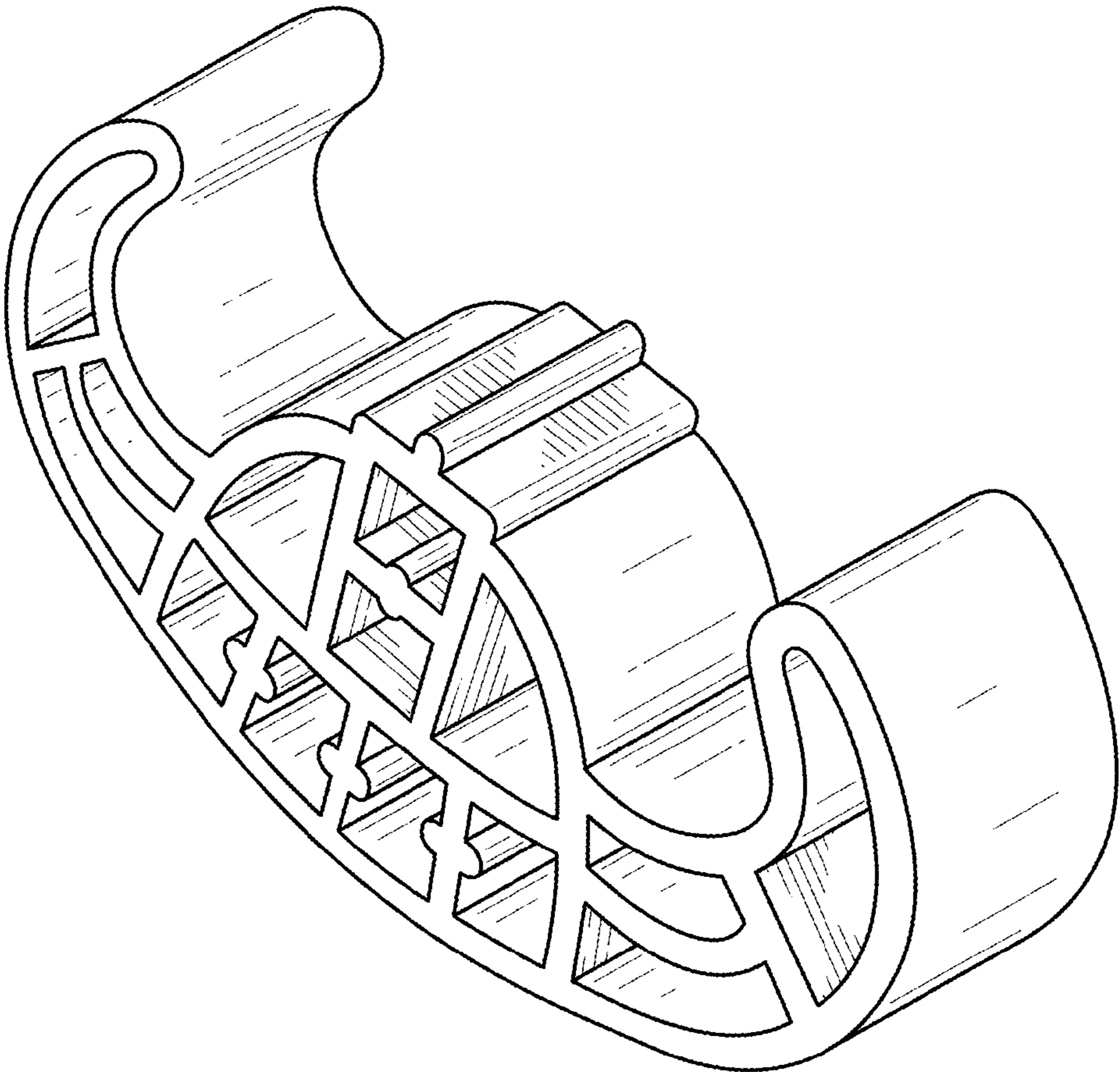

FIG. 8

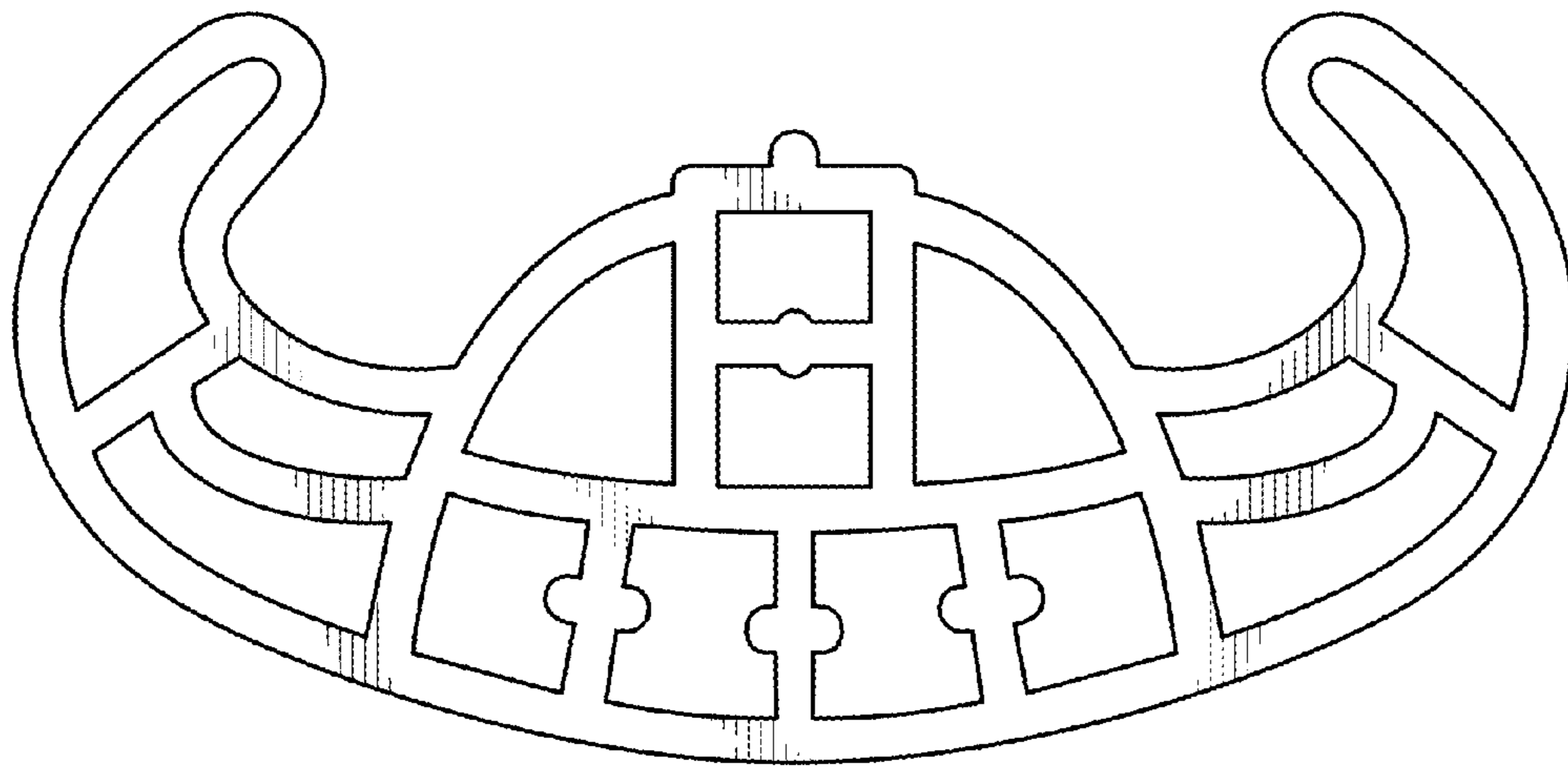

FIG. 9

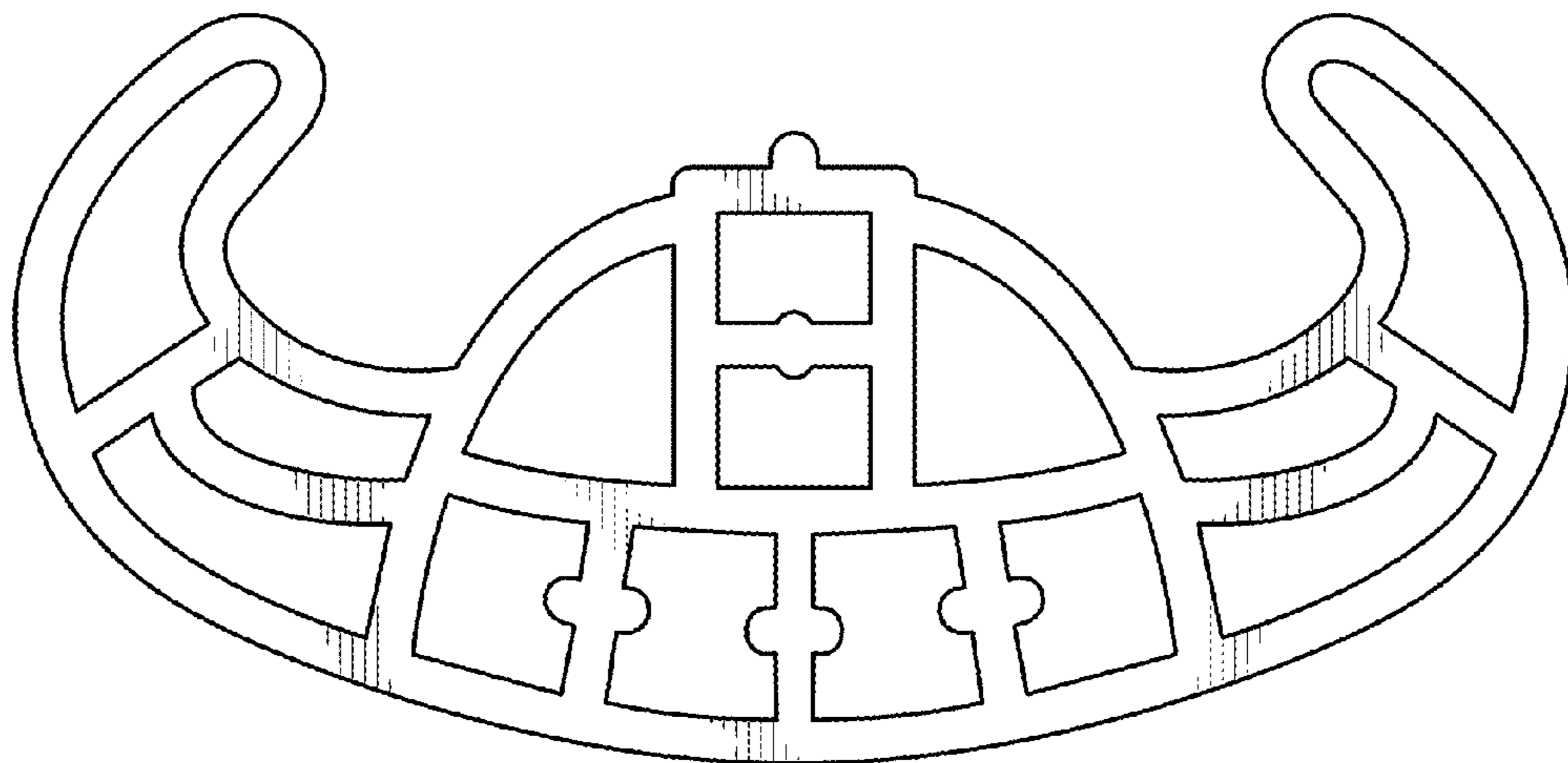

FIG. 10

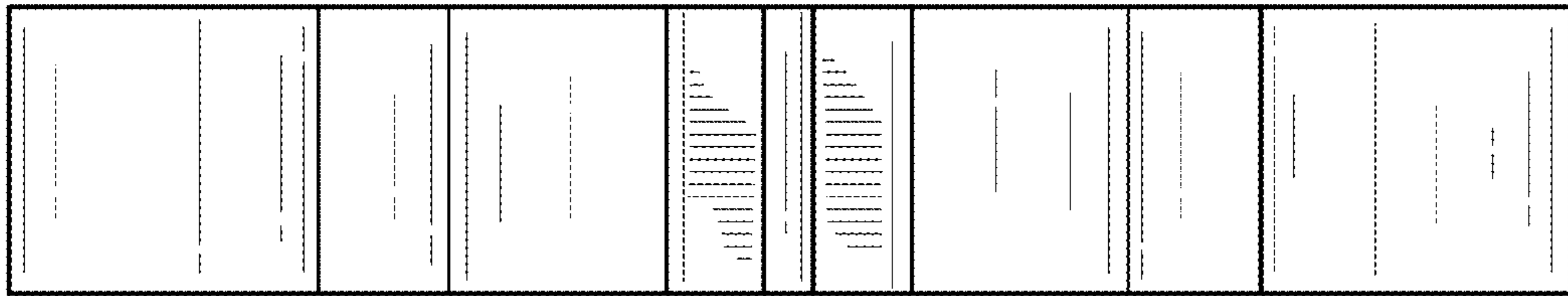

FIG. 11



FIG. 12

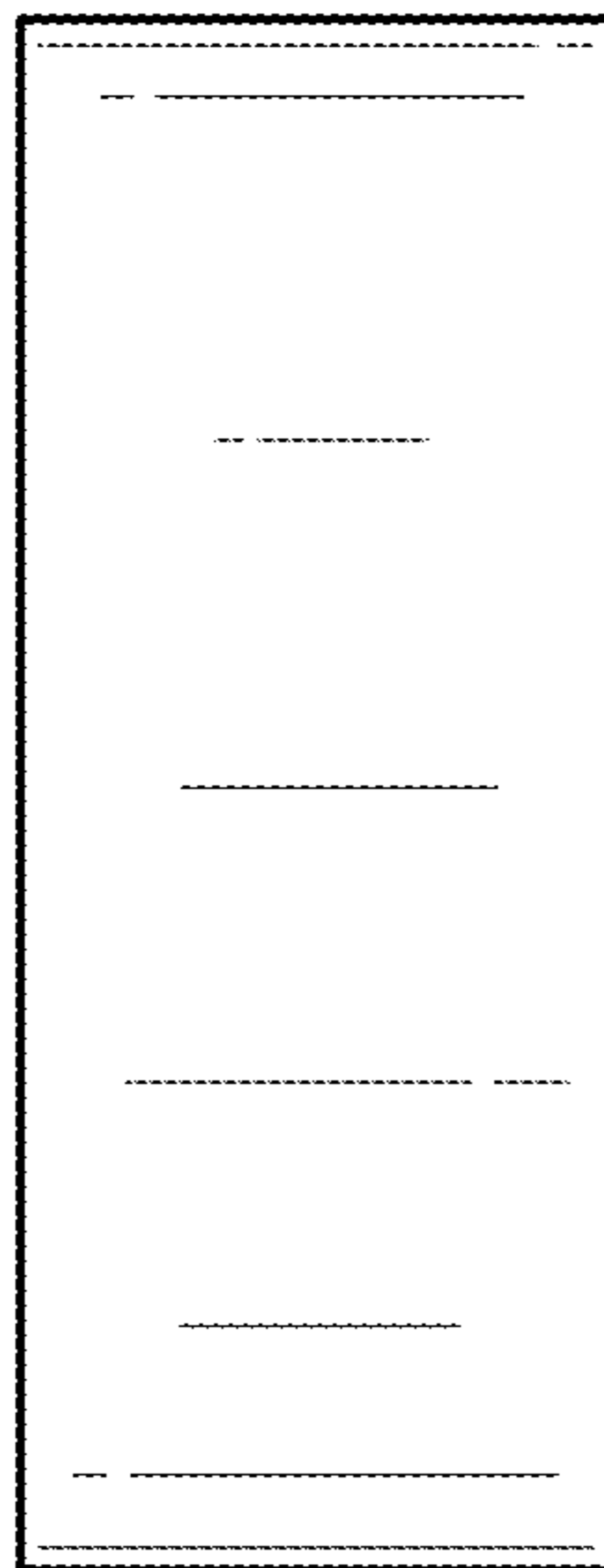

FIG. 13

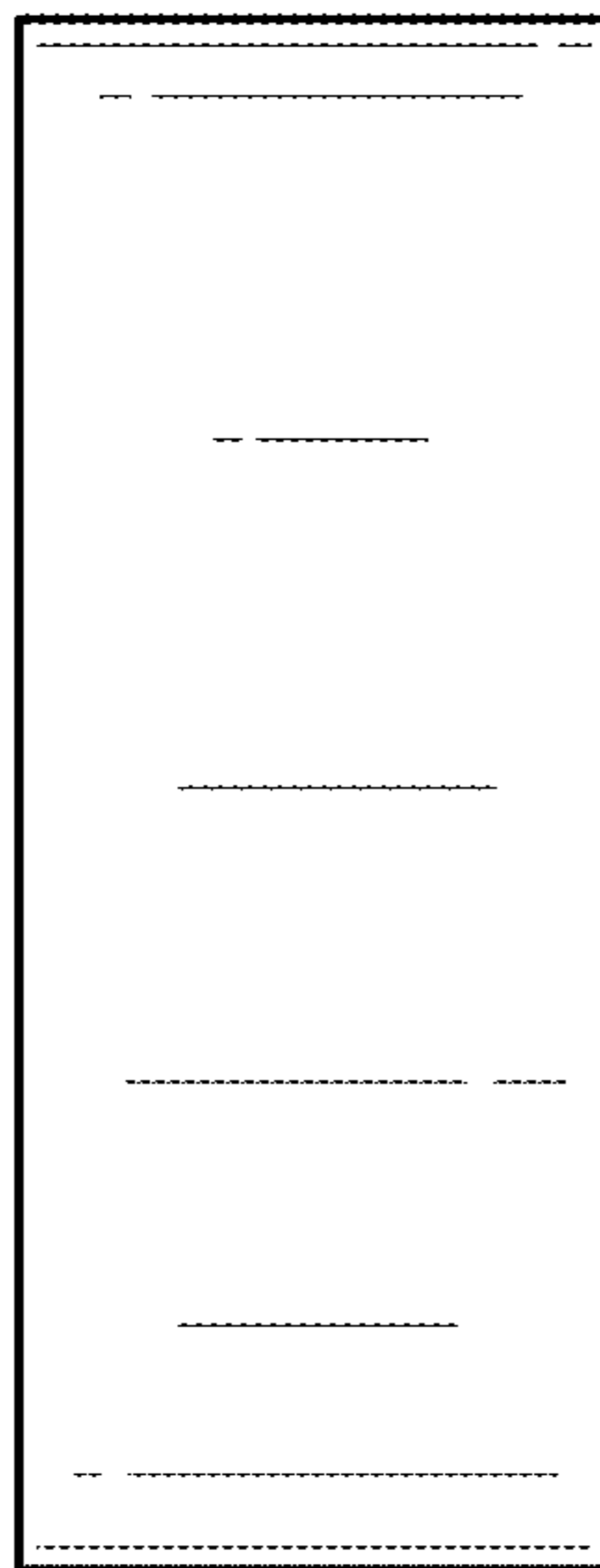

FIG. 14