



US00D748332S

(12) **United States Design Patent**  
**Wright et al.**

(10) **Patent No.:** **US D748,332 S**  
(45) **Date of Patent:** **\*\* Jan. 26, 2016**

(54) **HAIR ACCESSORY**

(71) Applicants: **Diana Wright**, Rumson, NJ (US);  
**Douglas Duprey**, Rumson, NC (US)

(72) Inventors: **Diana Wright**, Rumson, NJ (US);  
**Douglas Duprey**, Rumson, NC (US)

(\*\*) Term: **14 Years**

(21) Appl. No.: **29/494,138**

(22) Filed: **Jun. 17, 2014**

**Related U.S. Application Data**

(62) Division of application No. 29/410,240, filed on Jan. 5, 2012, now Pat. No. Des. 707,394.

(51) **LOC (10) Cl.** ..... **28-03**

(52) **U.S. Cl.**  
USPC ..... **D28/42**

(58) **Field of Classification Search**  
USPC ..... D28/21-34, 39-43; 132/101, 126,  
132/128-131, 144, 148, 219, 275-284  
CPC ..... A45D 8/24; A45D 8/00; A45D 8/02;  
A45D 8/04; A45D 8/06; A45D 8/08; A45D  
8/10; A45D 8/12; A45D 8/14; A45D 8/16;  
A45D 8/18; A45D 8/20; A45D 8/22; A45D  
8/26; A45D 8/28; A45D 8/30; A45D 8/32;  
A45D 8/34

See application file for complete search history.

(56) **References Cited**

U.S. PATENT DOCUMENTS

D182,232 S *	3/1958	Halpern .....	D28/42
D362,318 S *	9/1995	Corriher .....	D28/43
D368,852 S *	4/1996	Ikeda .....	D8/383
D439,507 S *	3/2001	Ikeda .....	D8/383
D551,067 S *	9/2007	Kawamura .....	D8/383
D559,668 S *	1/2008	Yoshie et al. ....	D8/383
D582,095 S *	12/2008	Minnelli .....	D28/42
D584,942 S *	1/2009	Yoshie .....	D8/383
D585,270 S *	1/2009	Yoshie .....	D8/383
D630,502 S *	1/2011	Ishii et al. ....	D8/383

\* cited by examiner

*Primary Examiner* — Zenia Bennett

(74) *Attorney, Agent, or Firm* — Ostrolenk Faber LLP

(57) **CLAIM**

The ornamental design for a hair accessory, as shown.

**DESCRIPTION**

FIG. 1 is a front and top perspective view a hair accessory showing my new design;  
FIG. 2 is a top view thereof;  
FIG. 3 is a front side view thereof, the rear side view being a mirror image thereof;  
FIG. 4 is a bottom view thereof;  
FIG. 5 is a left side view thereof; and,  
FIG. 6 is a right side view thereof.  
The broken lines show environmental matter only and form no part of the claimed design.

**1 Claim, 2 Drawing Sheets**

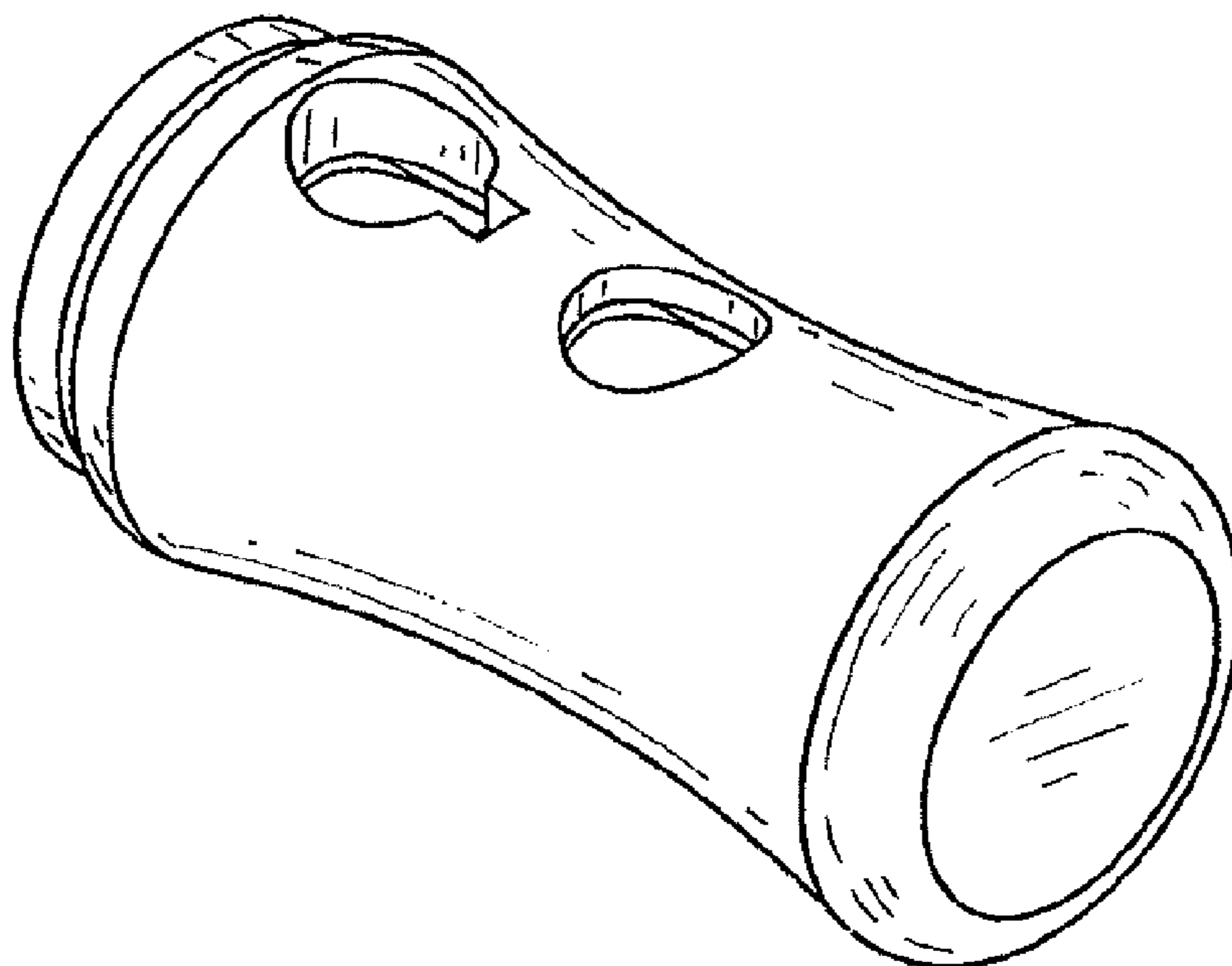

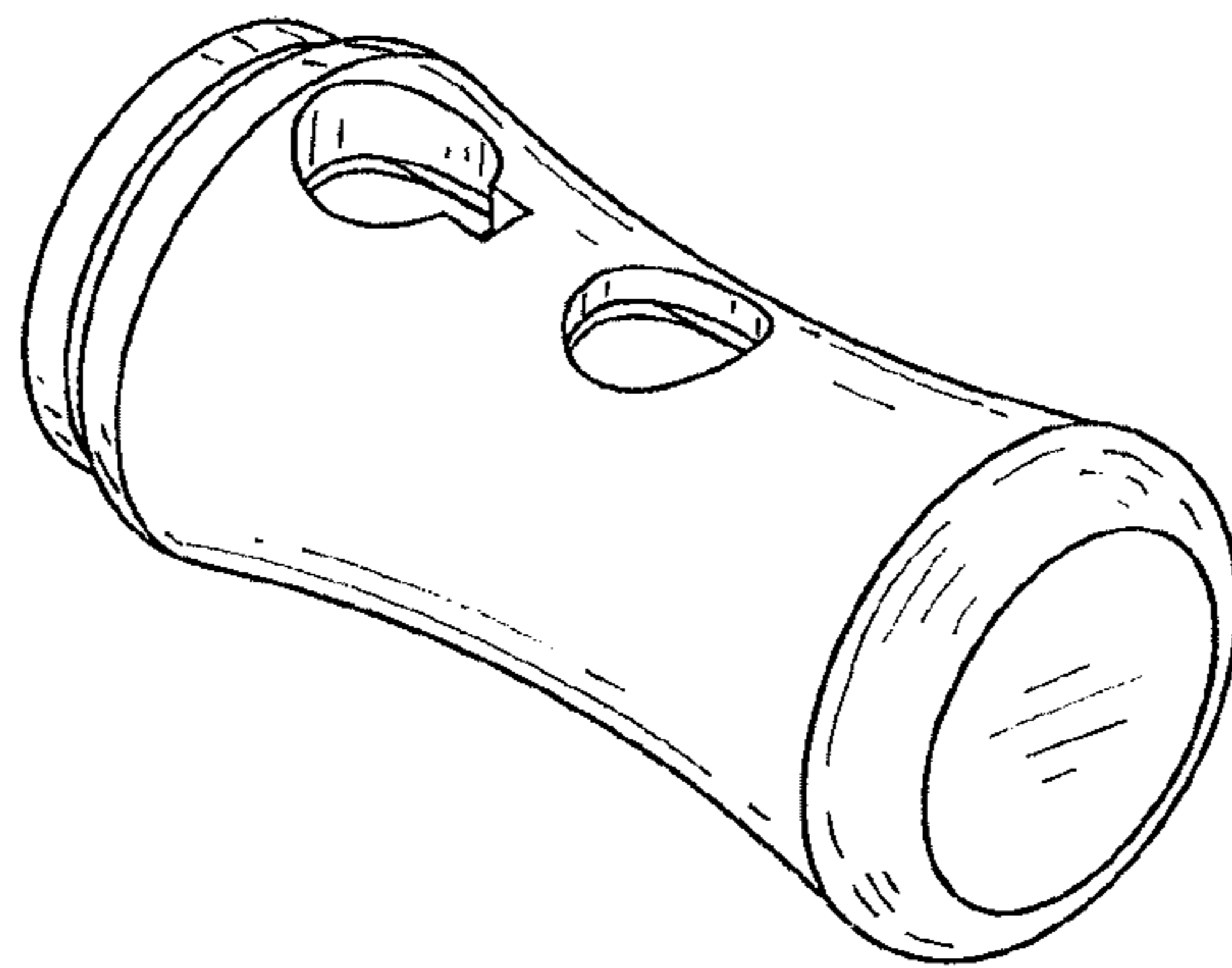

Fig. 1

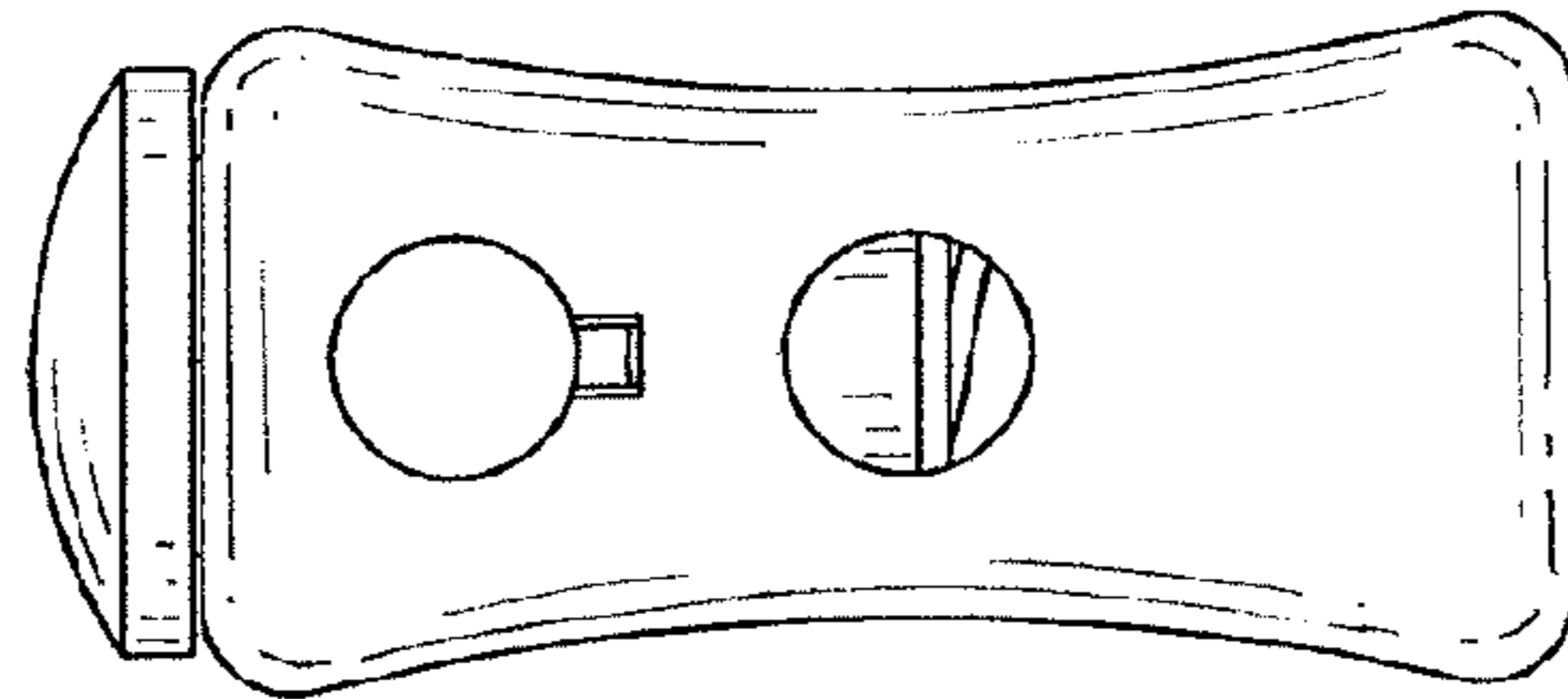

Fig. 2

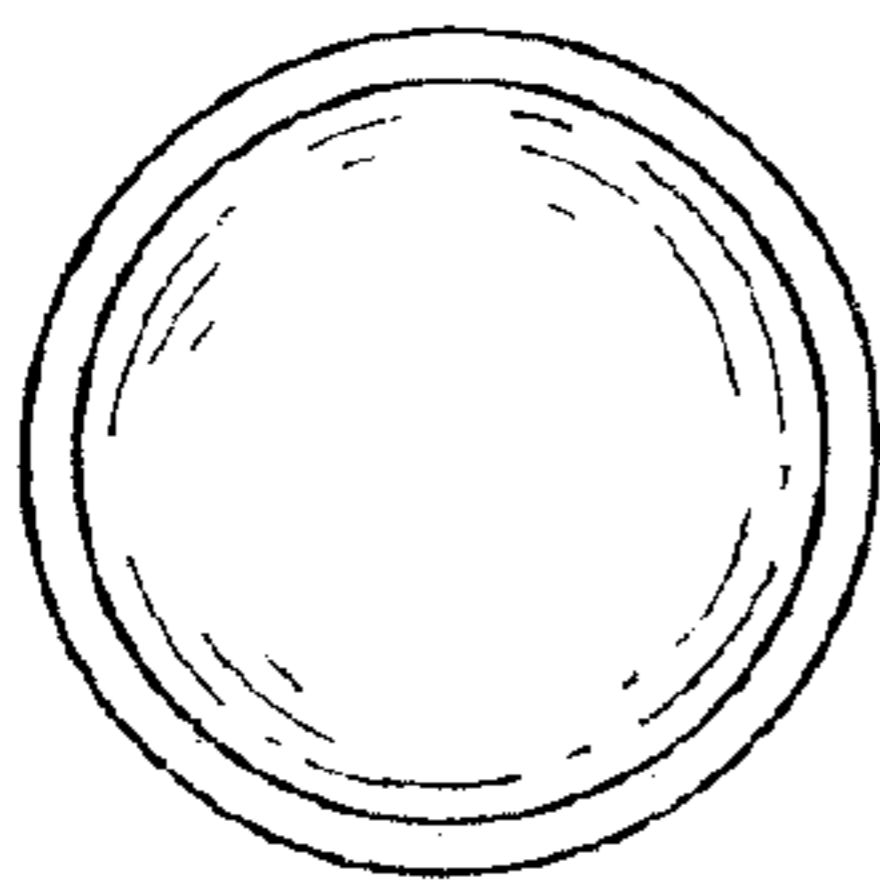

Fig. 5

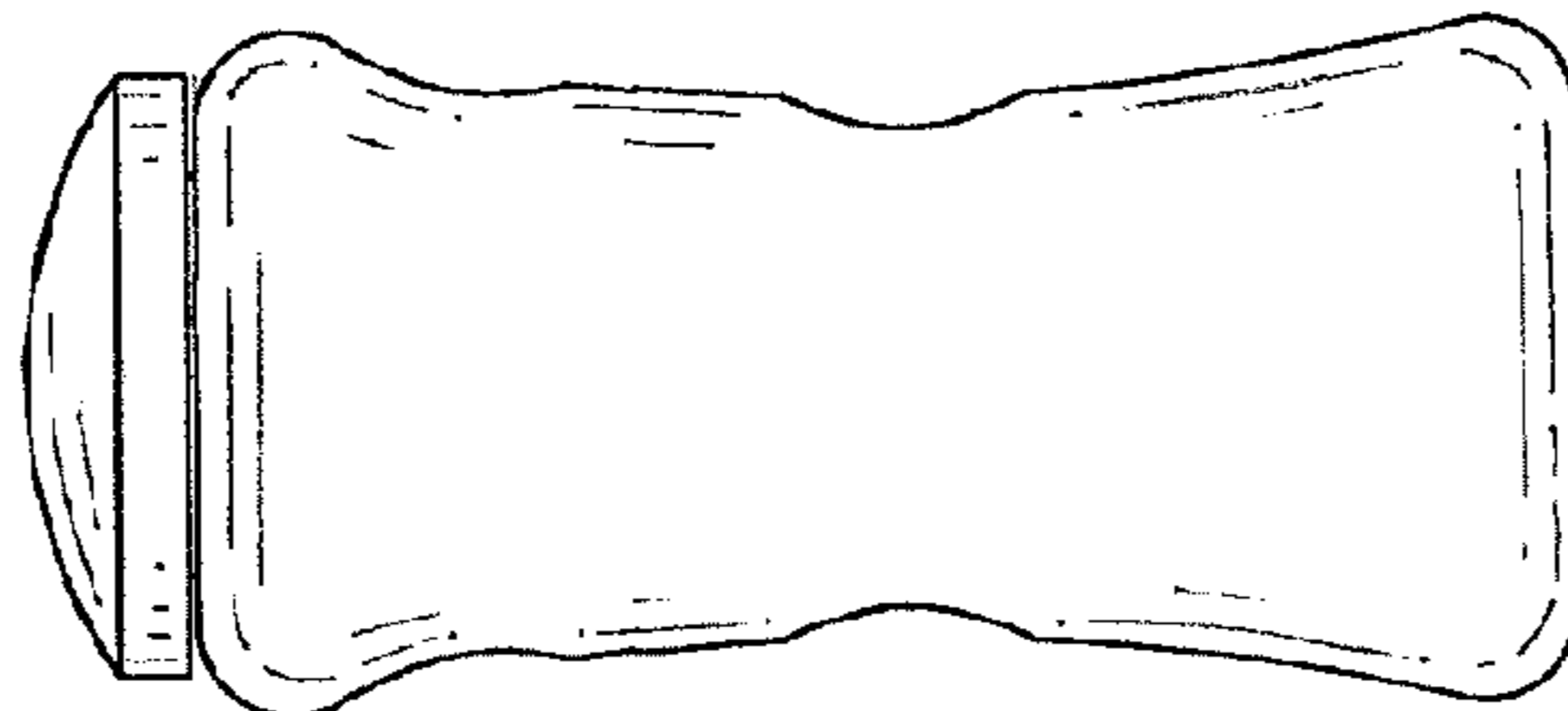

Fig. 3

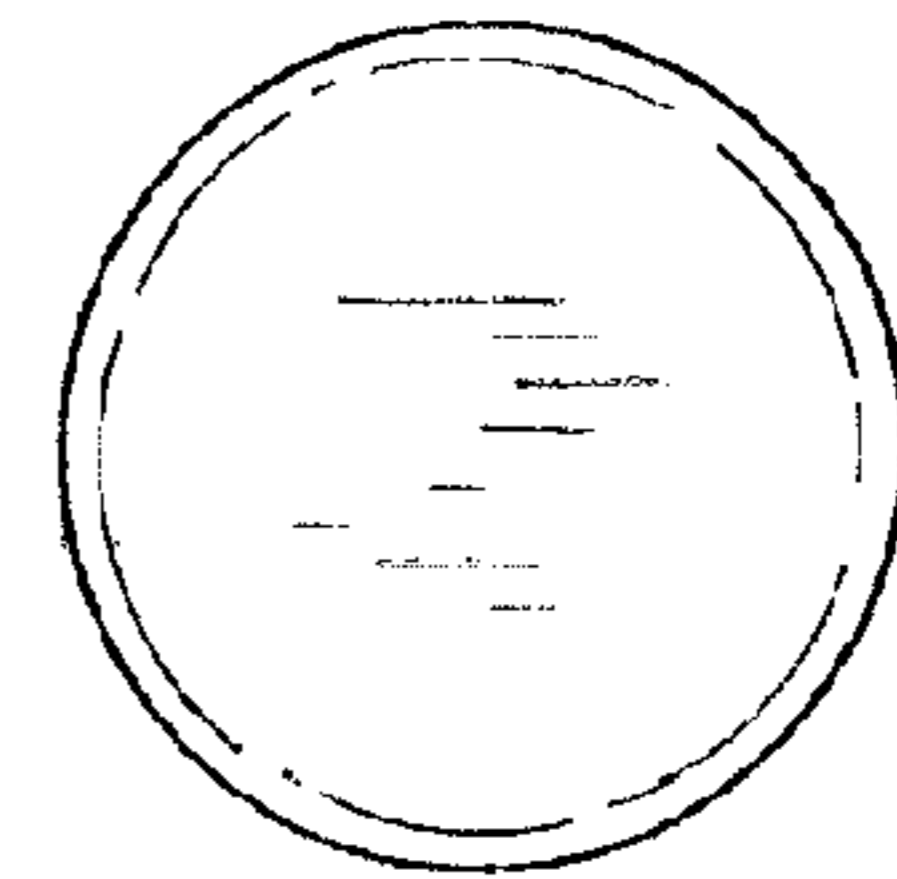

Fig. 6

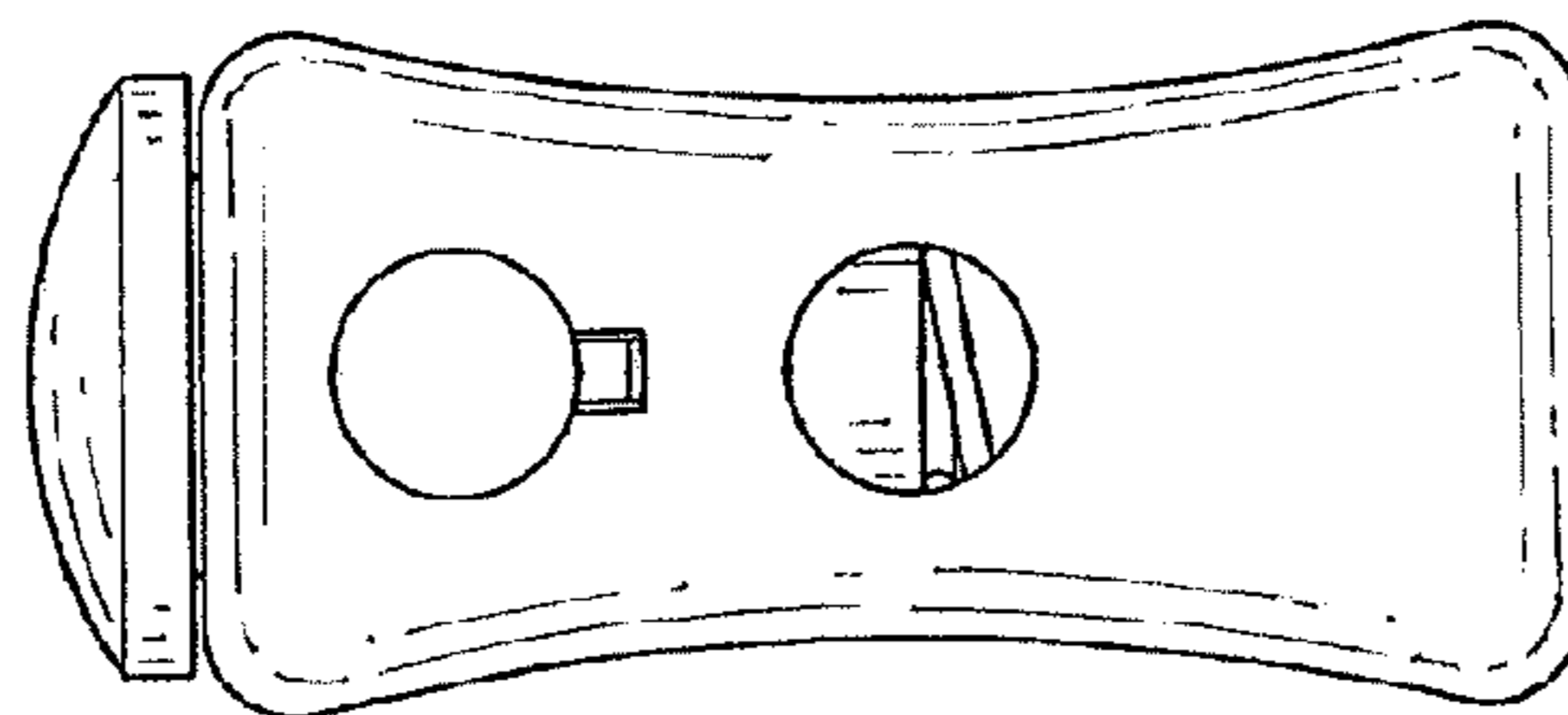

Fig. 4

UNITED STATES PATENT AND TRADEMARK OFFICE  
**CERTIFICATE OF CORRECTION**

PATENT NO. : D748,332 S  
APPLICATION NO. : 29/494138  
DATED : January 26, 2016  
INVENTOR(S) : Diana Wright et al.

Page 1 of 4

It is certified that error appears in the above-identified patent and that said Letters Patent is hereby corrected as shown below:

On the Title Page

Delete the title page and substitute therefore with the attached title page consisting of the corrected illustrative figure.

In the Drawings

Please replace FIGS. 1-6 with FIGS. 1-6 as shown on the attached pages.

Signed and Sealed this  
Eighteenth Day of September, 2018



Andrei Iancu  
*Director of the United States Patent and Trademark Office*

(12) **United States Design Patent** (10) **Patent No.:** **US D748,332 S**  
**Wright et al.** (45) **Date of Patent:** **\*\* Jan. 26, 2016**

(54) **HAIR ACCESSORY**

(71) Applicants: **Diana Wright**, Rumson, NJ (US);  
**Douglas Duprey**, Rumson, NC (US)

(72) Inventors: **Diana Wright**, Rumson, NJ (US);  
**Douglas Duprey**, Rumson, NC (US)

(\*\*) Term: **14 Years**

(21) Appl. No.: **29/494,138**

(22) Filed: **Jun. 17, 2014**

**Related U.S. Application Data**

(62) Division of application No. 29/410,240, filed on Jan. 5, 2012, now Pat. No. Des. 707,394.

(51) **LOC (10) Cl.** ..... **28-03**

(52) **U.S. Cl.**  
 USPC ..... **D28/42**

(58) **Field of Classification Search**  
 USPC ..... D28/21-34, 39-43; 132/101, 126,  
 132/128-131, 144, 148, 219, 275-284  
 CPC ..... A45D 8/24; A45D 8/00; A45D 8/02;  
 A45D 8/04; A45D 8/06; A45D 8/08; A45D  
 8/10; A45D 8/12; A45D 8/14; A45D 8/16;  
 A45D 8/18; A45D 8/20; A45D 8/22; A45D  
 8/26; A45D 8/28; A45D 8/30; A45D 8/32;  
 A45D 8/34

See application file for complete search history.

(56) **References Cited**

**U.S. PATENT DOCUMENTS**

D182,232 S *	3/1958	Halpern .....	D28/42
D362,318 S *	9/1995	Corriher .....	D28/43
D368,852 S *	4/1996	Ikeda .....	D8/383
D439,507 S *	3/2001	Ikeda .....	D8/383
D551,067 S *	9/2007	Kawamura .....	D8/383
D559,668 S *	1/2008	Yoshie et al. ....	D8/383
D582,095 S *	12/2008	Minnelli .....	D28/42
D584,942 S *	1/2009	Yoshie .....	D8/383
D585,270 S *	1/2009	Yoshie .....	D8/383
D630,502 S *	1/2011	Ishii et al. ....	D8/383

\* cited by examiner

*Primary Examiner* — **Zenia Bennett**  
 (74) *Attorney, Agent, or Firm* — **Ostrolenk Faber LLP**

(57) **CLAIM**  
 The ornamental design for a hair accessory, as shown.

**DESCRIPTION**

FIG. 1 is a front and top perspective view a hair accessory showing my new design;  
 FIG. 2 is a top view thereof;  
 FIG. 3 is a front side view thereof, the rear side view being a mirror image thereof;  
 FIG. 4 is a bottom view thereof;  
 FIG. 5 is a left side view thereof; and,  
 FIG. 6 is a right side view thereof.  
 The broken lines show environmental matter only and form no part of the claimed design.

**1 Claim, 2 Drawing Sheets**

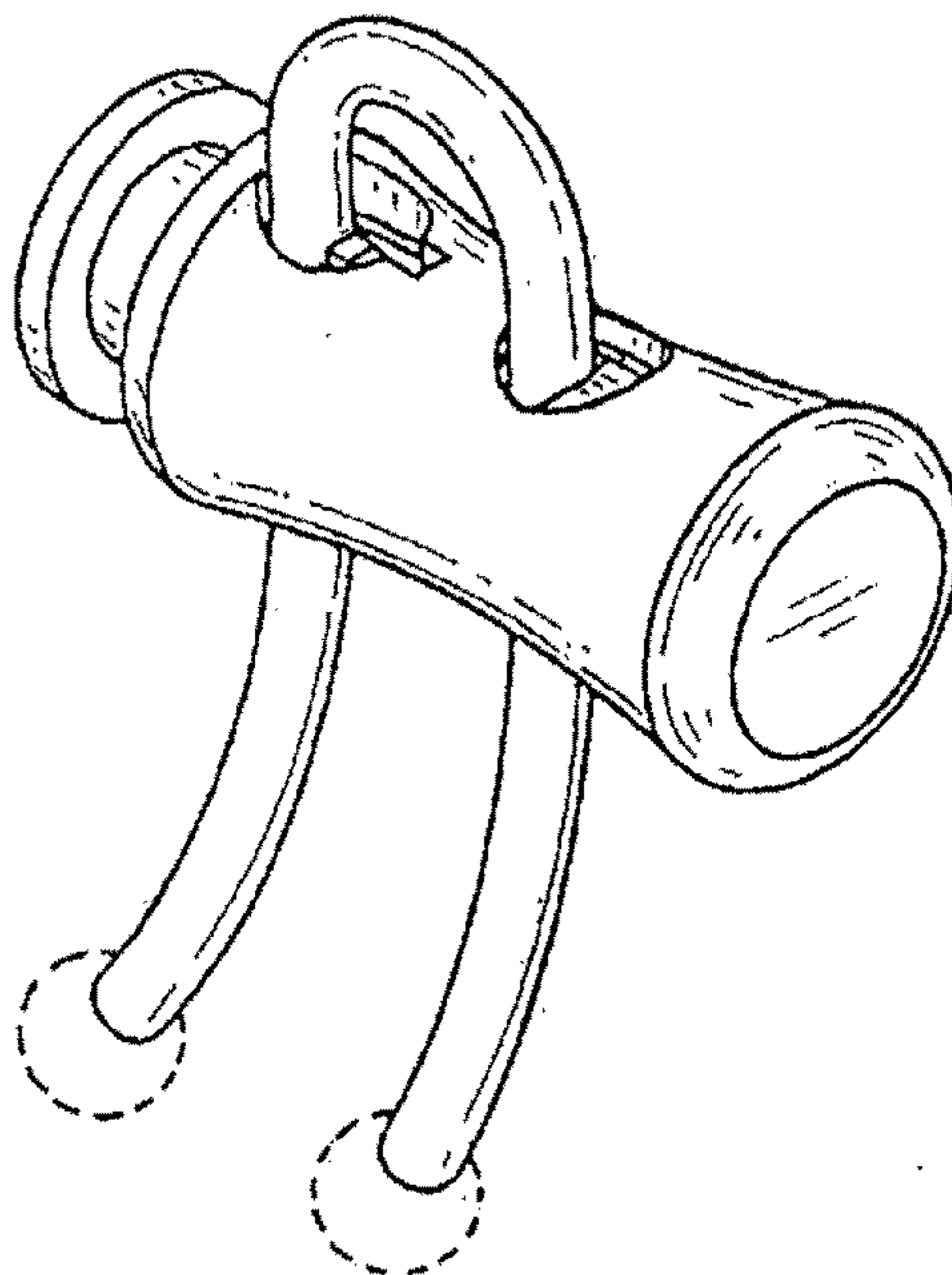

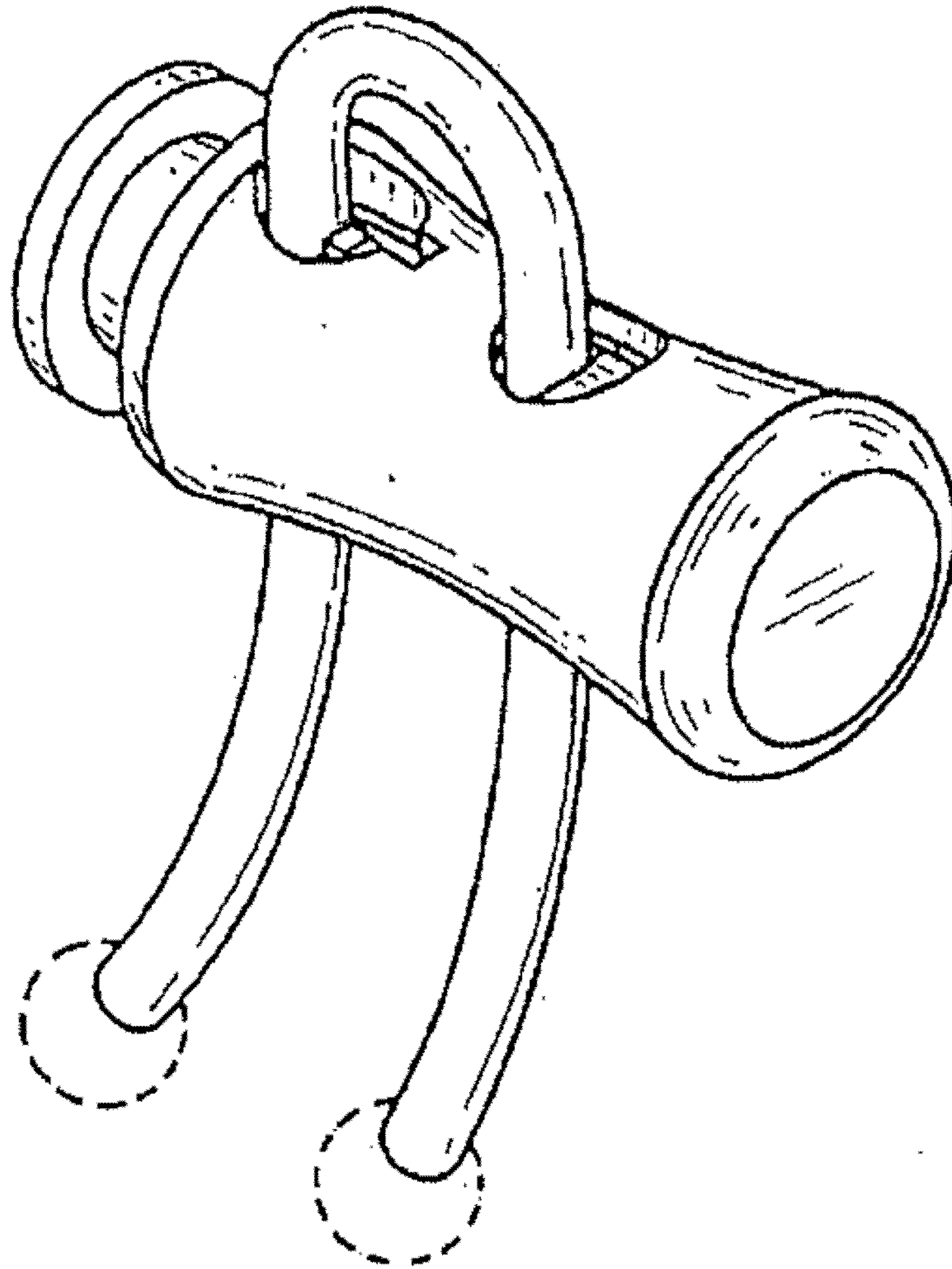

Fig. 1

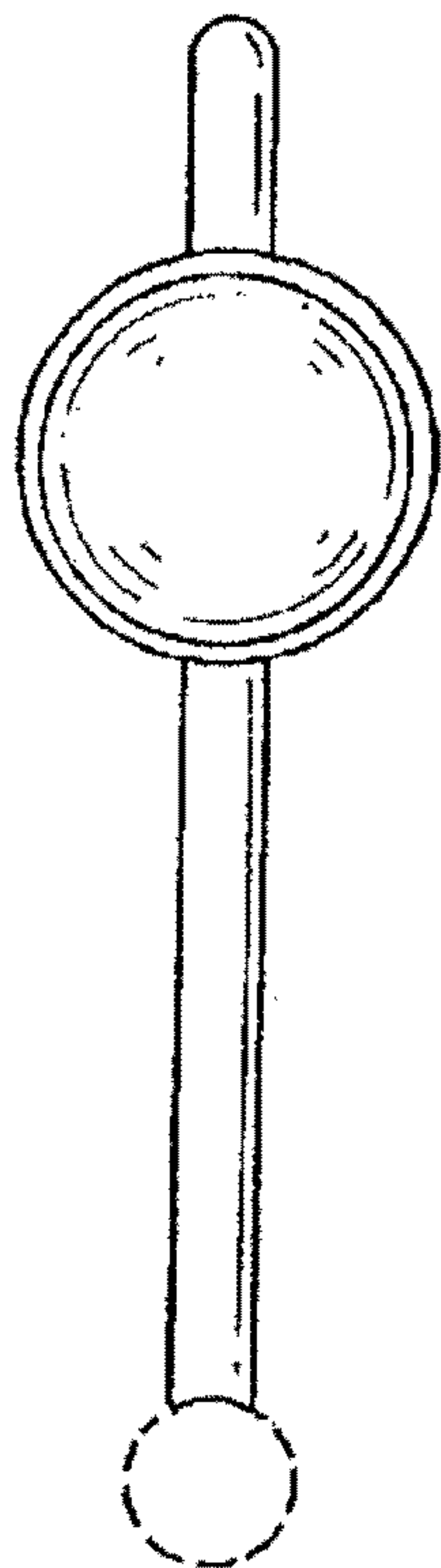

Fig. 5

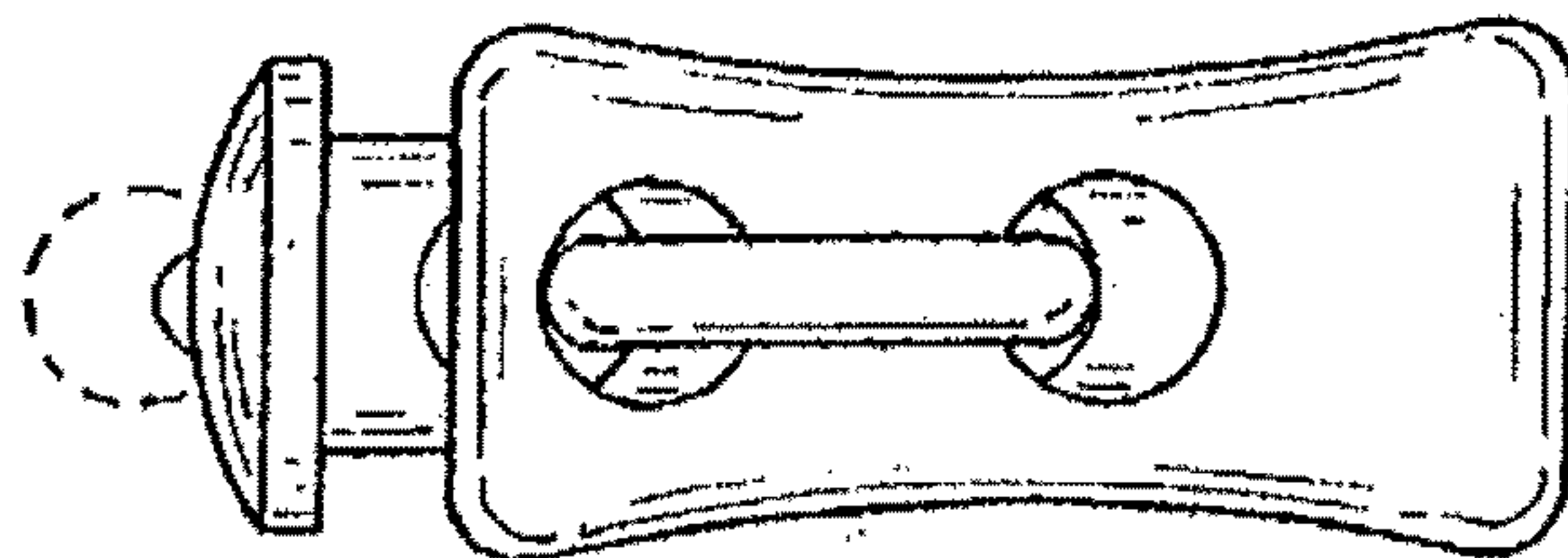

Fig. 2

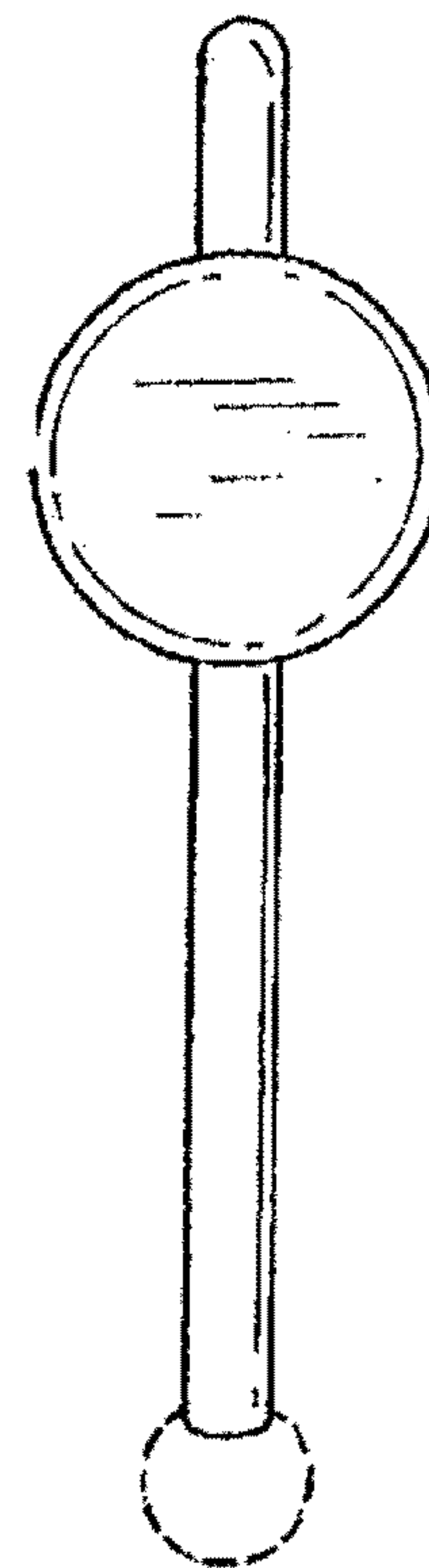

Fig. 6

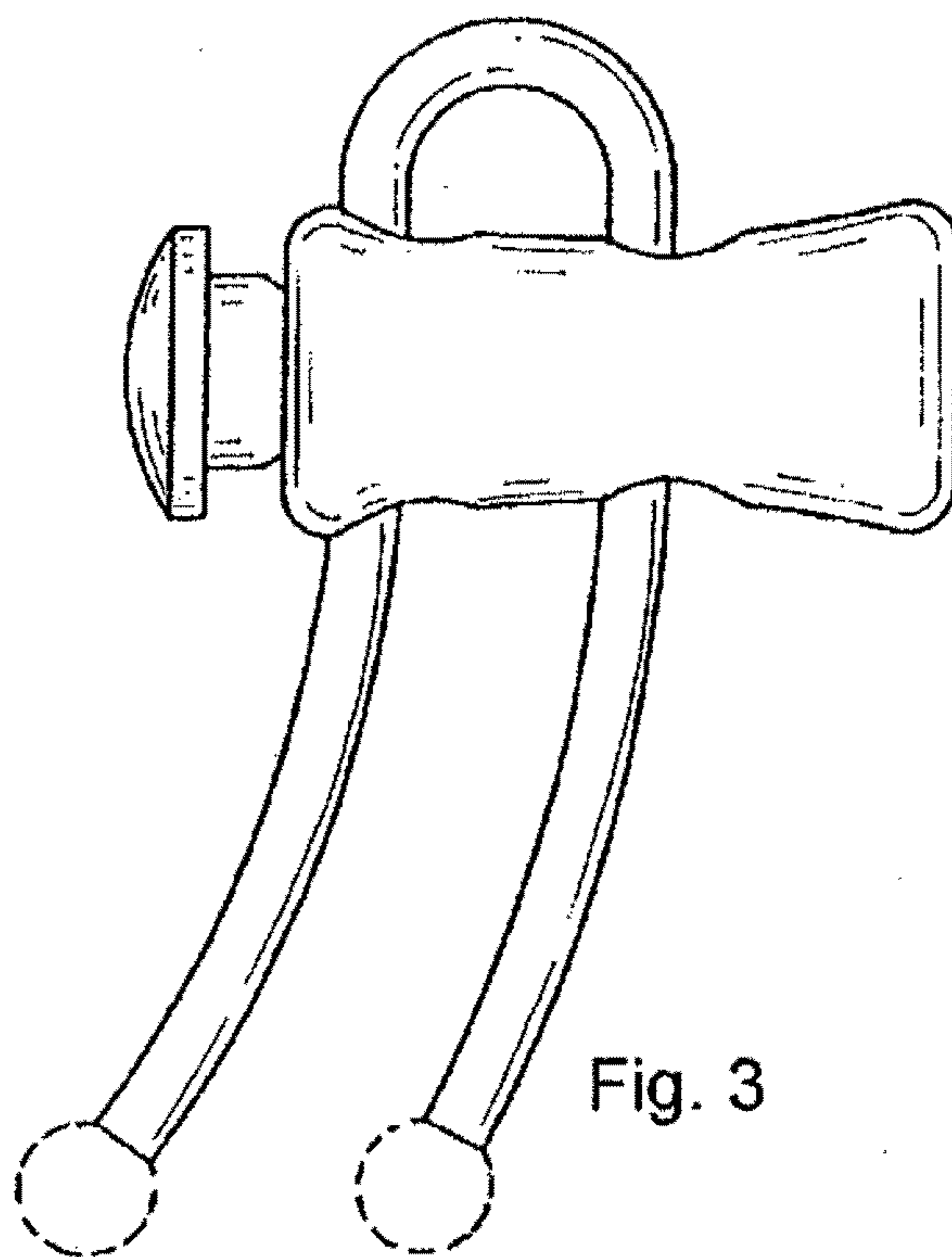

Fig. 3

Fig. 4

