



US00D748194S

(12) **United States Design Patent**
St. John

(10) **Patent No.:** **US D748,194 S**
(45) **Date of Patent:** **** Jan. 26, 2016**

- (54) **BOOK JACKET**
- (71) Applicant: **Tracy St. John**, Sausalito, CA (US)
- (72) Inventor: **Tracy St. John**, Sausalito, CA (US)
- (**) Term: **14 Years**
- (21) Appl. No.: **29/524,214**
- (22) Filed: **Apr. 17, 2015**
- (51) **LOC (10) Cl.** **19-04**
- (52) **U.S. Cl.**
USPC **D19/26**
- (58) **Field of Classification Search**
USPC D6/626, 632, 407; D3/303, 301;
D19/27, 26, 90, 30, 31; D9/423;
D8/105
CPC B42C 1/00; B42C 3/00; B42C 17/00
See application file for complete search history.

- D338,455 S * 8/1993 Suge D14/345
- D350,271 S * 9/1994 Landy D26/38
- D356,111 S * 3/1995 Casteneda, Jr. D19/27
- D364,327 S * 11/1995 Graham D8/105
- D399,405 S * 10/1998 Savoia D8/105
- D404,762 S * 1/1999 Vogel D19/27
- 6,047,619 A * 4/2000 Anderson B25F 1/003
7/118
- D427,875 S * 7/2000 Chiu D8/105
- D433,057 S * 10/2000 Chu D18/7
- D433,915 S * 11/2000 Elsener, Sr. D8/105
- D434,797 S * 12/2000 Meyerhoff D19/26
- D434,961 S * 12/2000 Elsener, Sr. D8/105
- D448,267 S * 9/2001 Jean D8/105
- D452,524 S 12/2001 Fernandes et al.

(Continued)

Primary Examiner — T. Chase Nelson
Assistant Examiner — Michelle E Wilson
(74) *Attorney, Agent, or Firm* — Cislo & Thomas, LLP

(57) **CLAIM**
I claim the ornamental design for a book jacket, as shown and described.

(56) **References Cited**

U.S. PATENT DOCUMENTS

- 2,147,369 A * 2/1939 Grumbacher B42B 5/12
281/27.2
- 2,193,348 A * 3/1940 Schade B42B 5/12
281/27.2
- 2,194,010 A * 3/1940 Cooke G09F 7/00
40/119
- 2,228,355 A * 1/1941 Key B42B 5/12
402/26
- 2,299,319 A * 10/1942 Gale B42D 5/005
281/19.1
- D153,988 S 5/1949 Smoleroff
- 2,657,071 A * 10/1953 Busse B42B 5/12
281/19.2
- D172,725 S * 7/1954 Polk D27/142
- D201,663 S * 7/1965 Bifare D19/27
- D278,722 S 5/1985 Becker et al.
- D302,102 S 7/1989 Amagaya
- D321,211 S * 10/1991 Moor D19/27
- D330,115 S * 10/1992 O'Brien D19/27

DESCRIPTION

FIG. 1 is a top perspective view in a closed configuration of my book jacket;
FIG. 2 is a left side view in a closed configuration thereof;
FIG. 3 is a front view in a closed configuration thereof;
FIG. 4 is a bottom view in a closed configuration thereof;
FIG. 5 is a top view in a closed configuration thereof;
FIG. 6 is a front view in a closed configuration thereof;
FIG. 7 is a front perspective view in an open configuration thereof;
FIG. 8 is a front view in an open configuration thereof;
FIG. 9 is a left side view in an open configuration thereof; and,
FIG. 10 is a front view in a closed configuration of my book jacket.
The broken lines are for environmental purposes only and form no part of the claimed design.

1 Claim, 7 Drawing Sheets

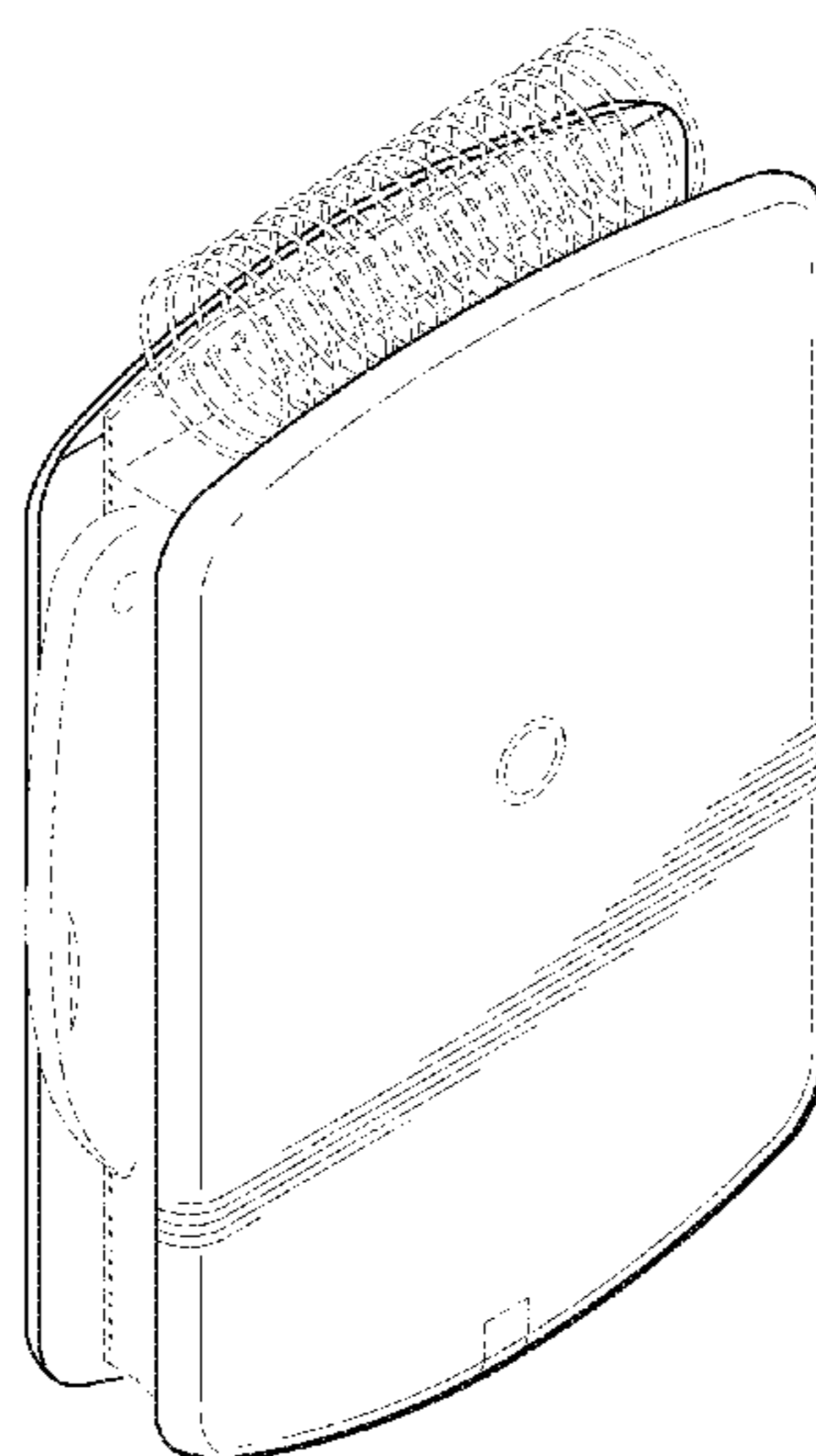

(56)

References Cited

U.S. PATENT DOCUMENTS

D482,984 S *	12/2003	Marchand	D11/79	D590,016 S *	4/2009	Weinstein	D19/27
D495,360 S *	8/2004	Keagy	D19/26	D602,079 S *	10/2009	Auster	D19/27
D509,318 S *	9/2005	Poinstingl	D27/143	D610,893 S *	3/2010	Mudrick	D8/105
7,059,741 B2 *	6/2006	Elsener	B25F 1/04 362/109	D617,831 S *	6/2010	Scroggins	D19/27
D569,214 S *	5/2008	Telfser	D8/105	D617,832 S *	6/2010	Scroggins	D19/27
7,393,017 B2 *	7/2008	Carmichael	B42D 5/00 281/15.1	D645,722 S *	9/2011	Yamaguchi	D8/105
D586,391 S *	2/2009	Pascale	D19/27	D657,651 S *	4/2012	Rubin	D8/105
					2004/0253045 A1 *	12/2004	Walley	B42B 5/12 402/57
					2005/0081302 A1 *	4/2005	Elsener	B25F 1/04 7/118

* cited by examiner

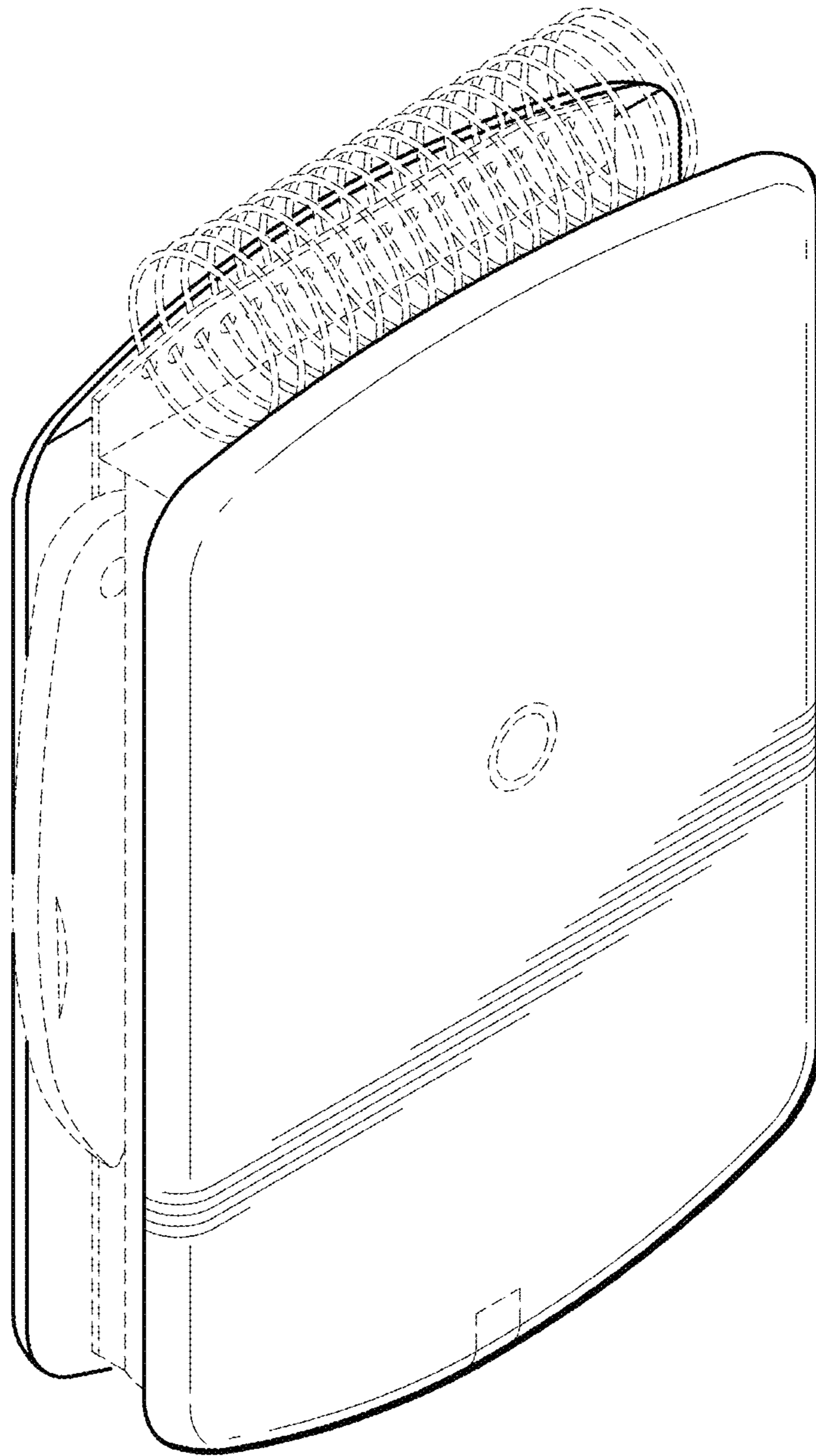

FIG. 1

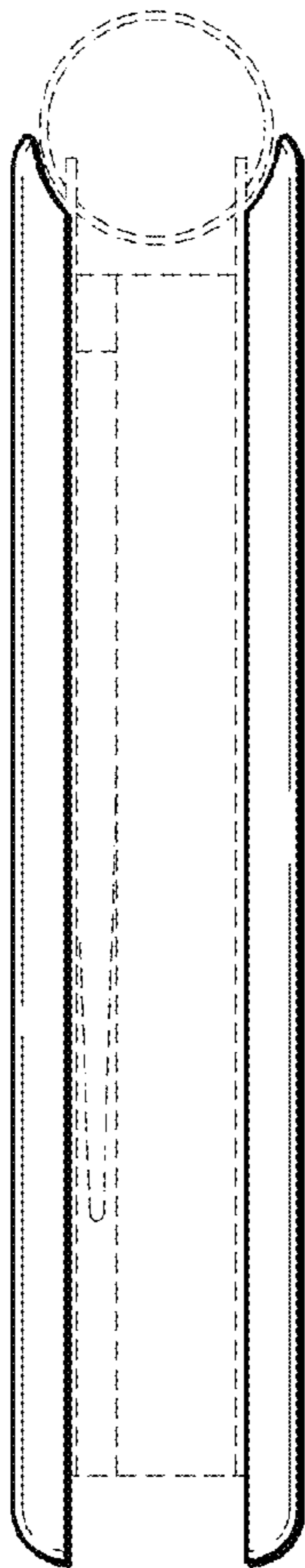

FIG. 2

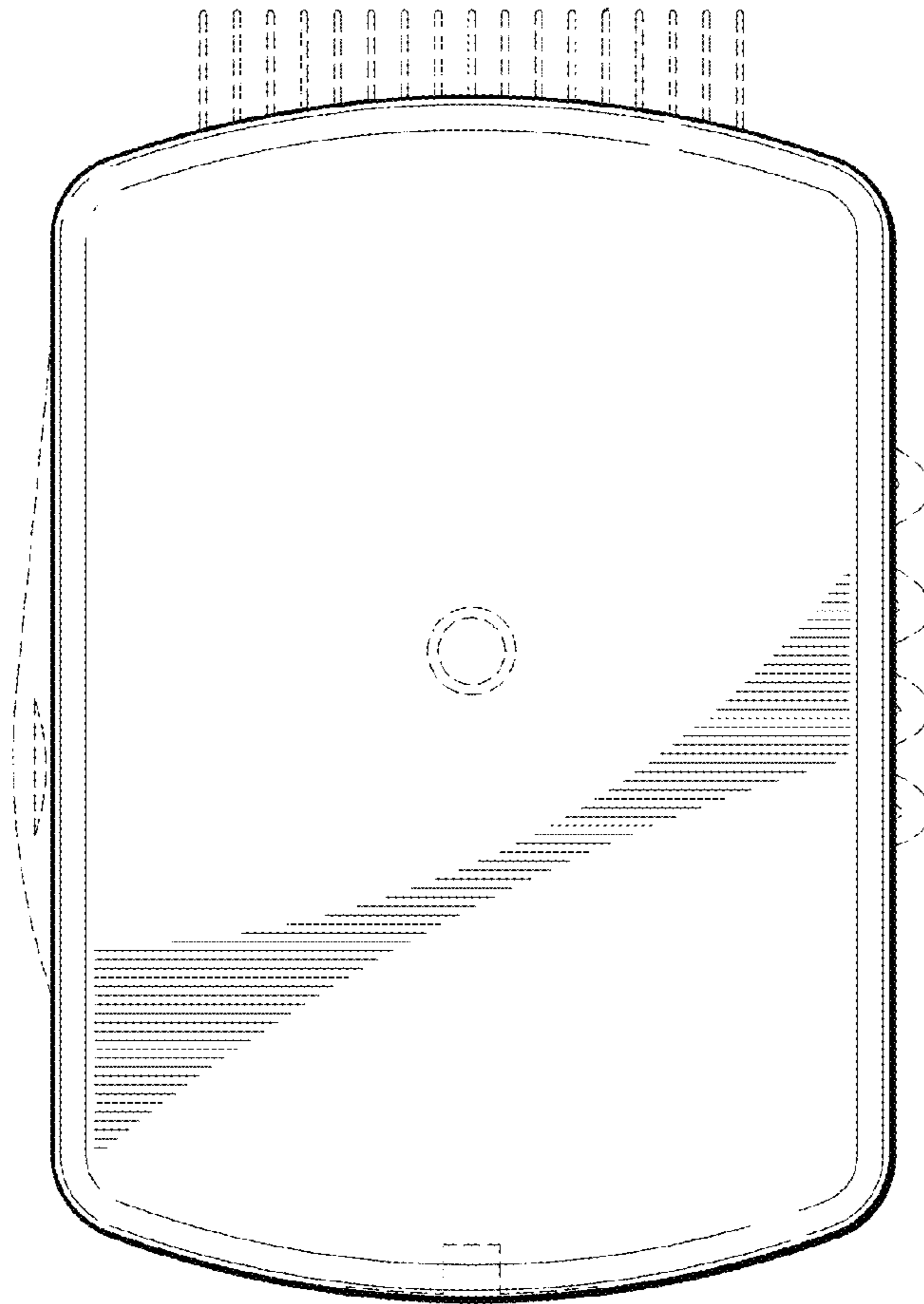

FIG. 3

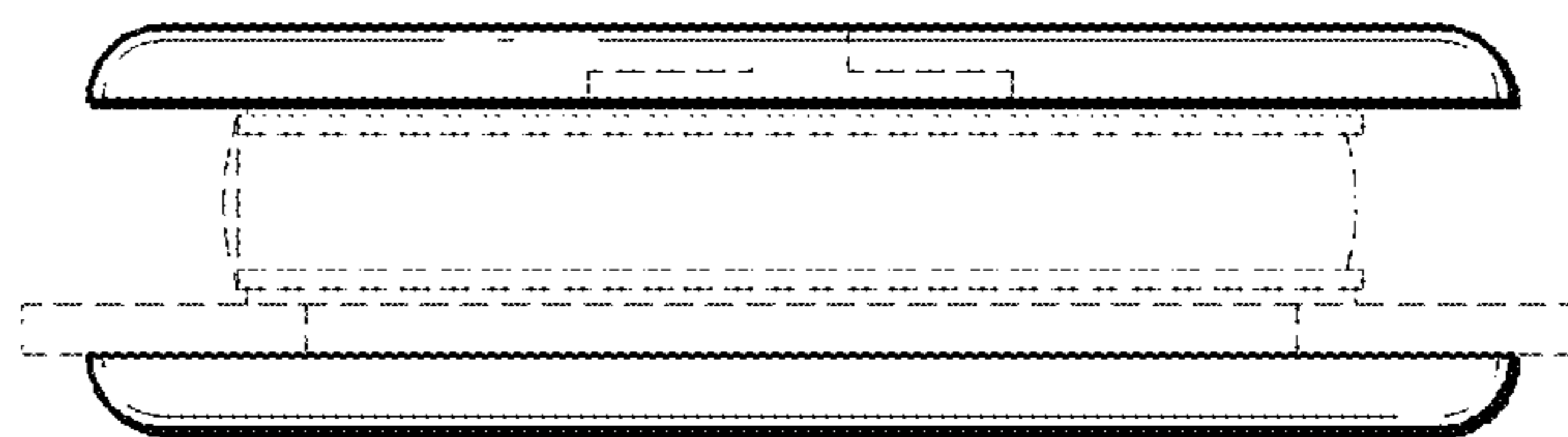

FIG. 4

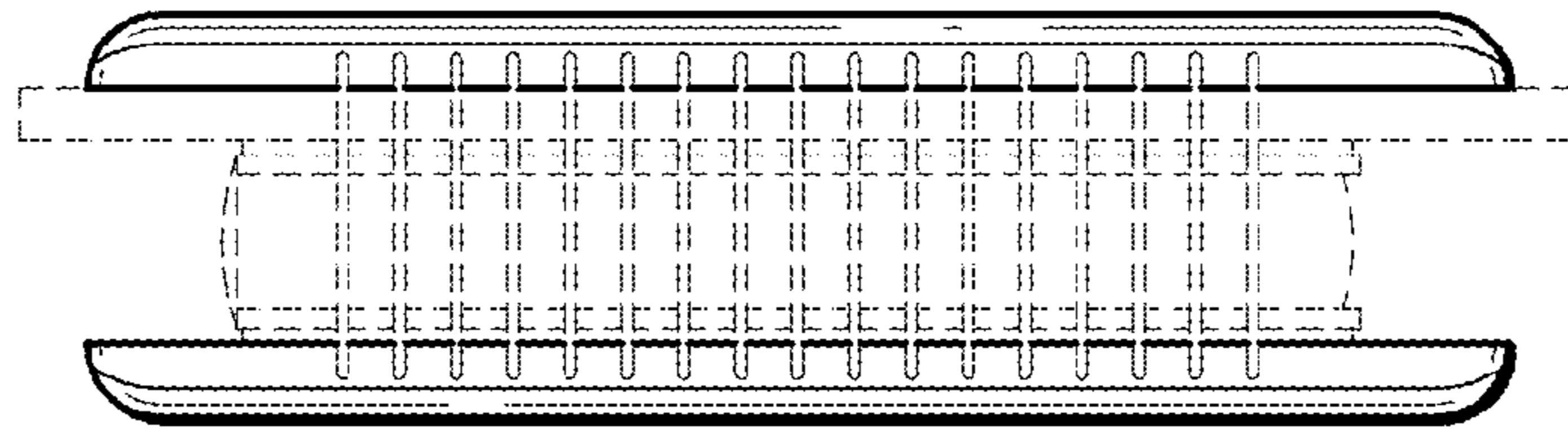

FIG. 5

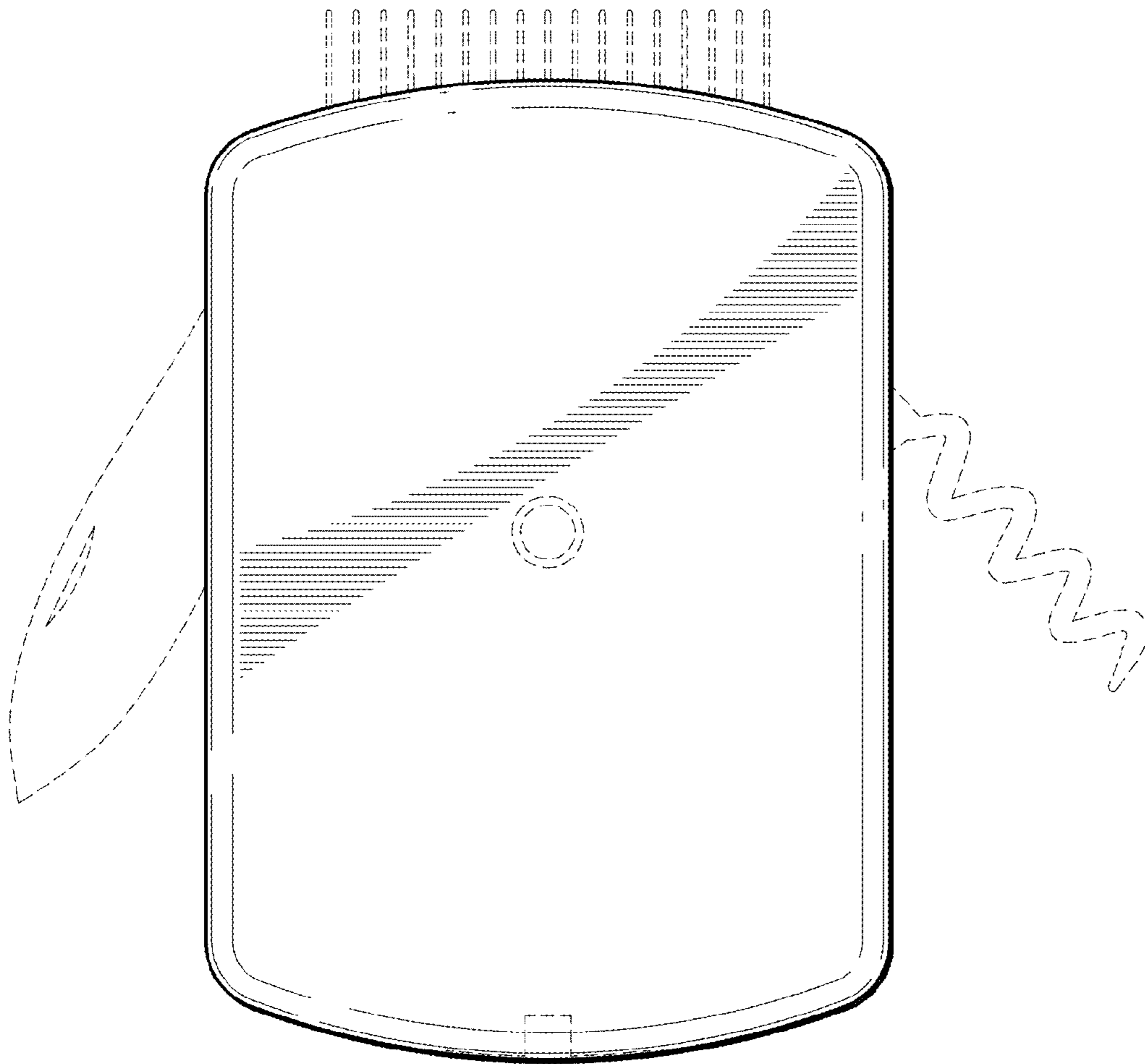

FIG. 6

FIG. 7

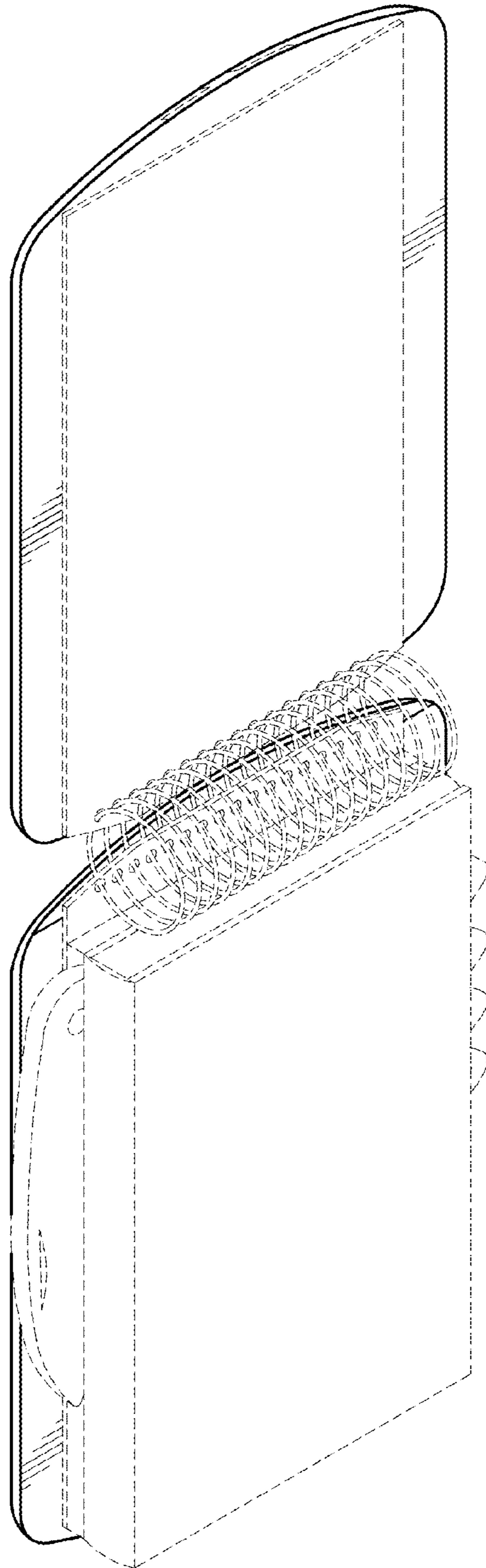

FIG. 8

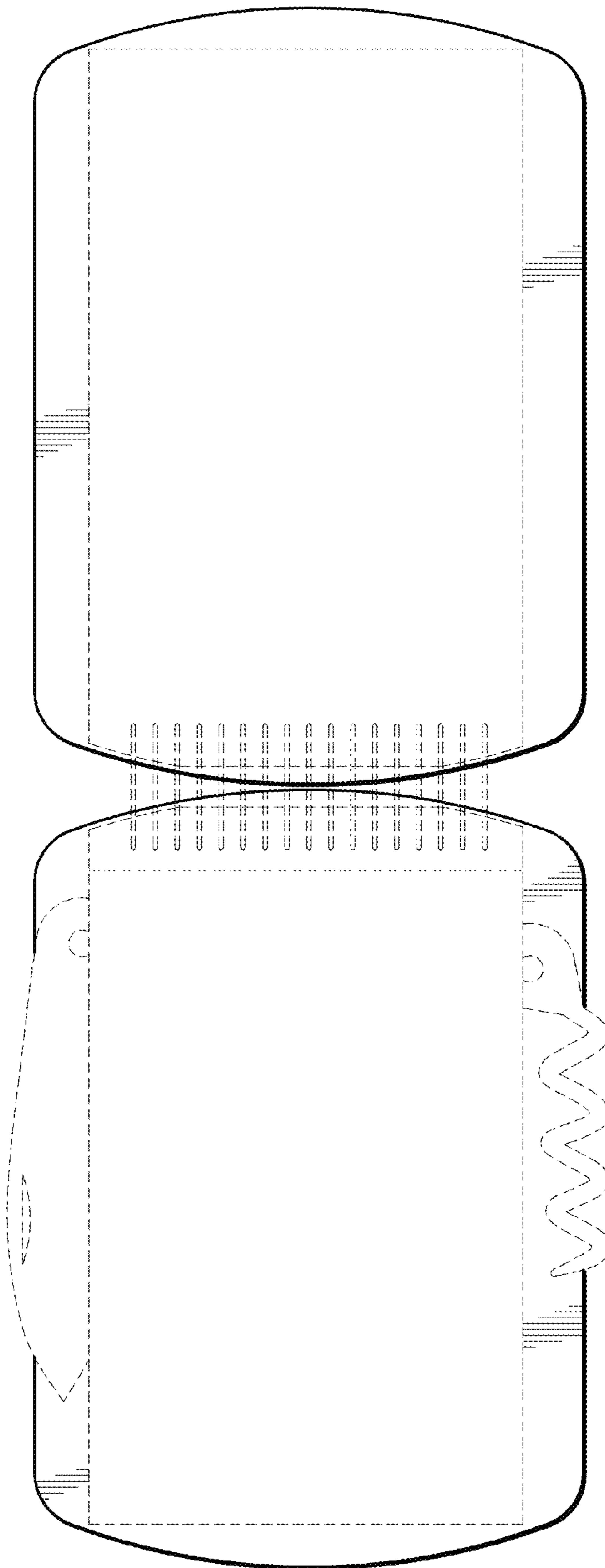
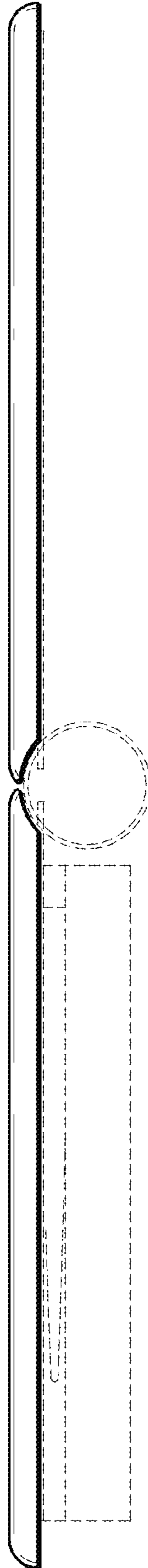

FIG. 9



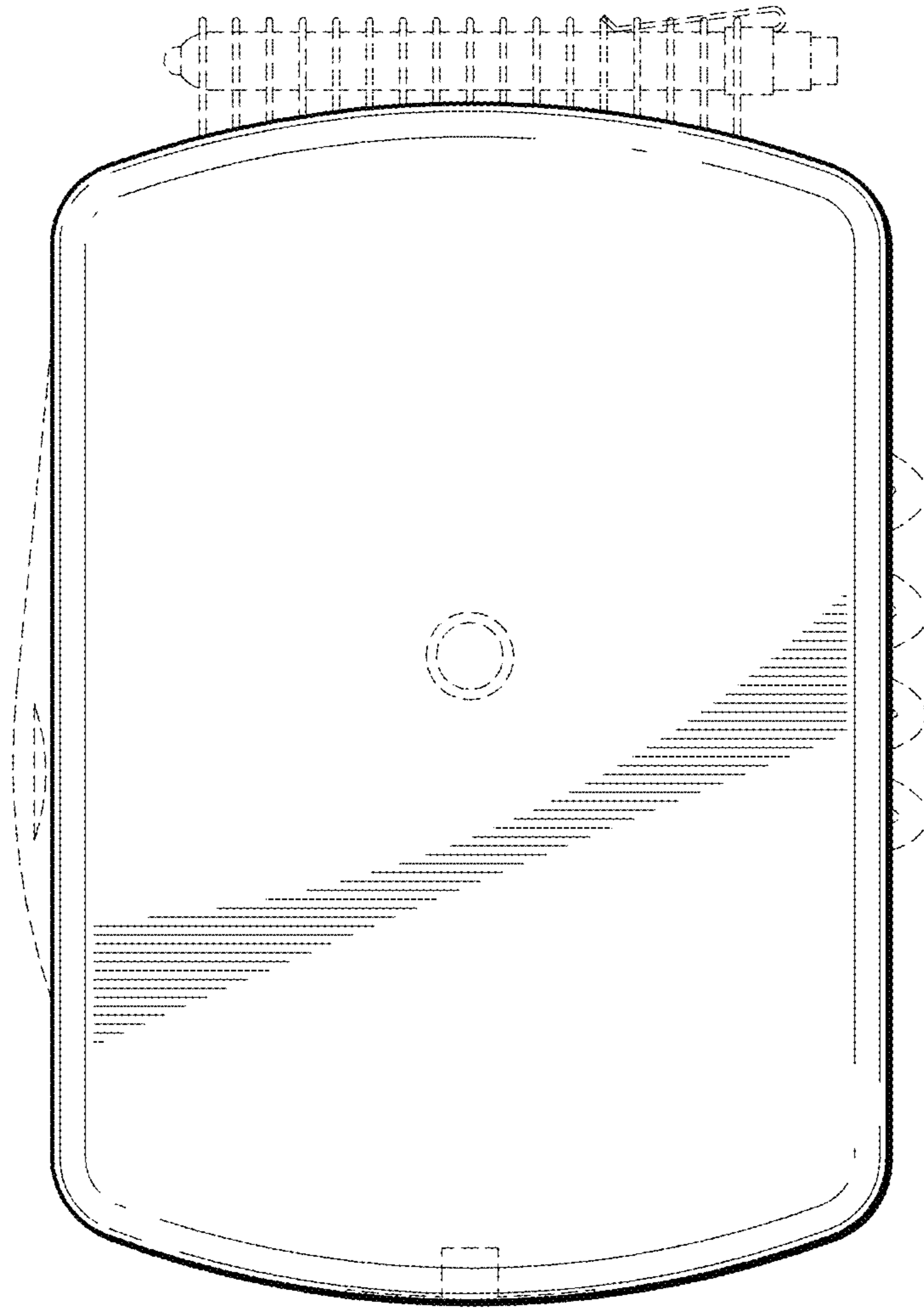

FIG. 10