



US00D748188S

(12) **United States Design Patent**
Shin

(10) **Patent No.:** **US D748,188 S**
(45) **Date of Patent:** **** Jan. 26, 2016**

- (54) **EYEGLASSES**
- (71) Applicant: **Oakley, Inc.**, Foothill Ranch, CA (US)
- (72) Inventor: **Jae Shin**, Irvine, CA (US)
- (73) Assignee: **Oakley, Inc.**, Foothill Ranch, CA (US)
- (**) Term: **14 Years**
- (21) Appl. No.: **29/509,894**
- (22) Filed: **Nov. 21, 2014**
- (51) **LOC (10) Cl.** **16-06**
- (52) **U.S. Cl.**
USPC **D16/326**
- (58) **Field of Classification Search**
USPC D16/300, 304, 309-311, 314-330,
D16/334-338, 341; D29/109, 110;
D21/483, 660, 661; D14/372;
351/41-46, 48, 49, 51, 52, 59, 61-63,
351/92, 103-126, 140-153, 158, 159, 178;
2/13, 15, 426-432, 434-437, 441, 447,
2/448, 449
CPC G02C 2200/08; G02C 1/06; G02C 5/14;
G02C 5/16
See application file for complete search history.

- D323,333 S 1/1992 Jannard et al.
- 5,137,242 A * 8/1992 Reath A47F 7/021
248/309.1
- 5,270,743 A * 12/1993 Hofmair G02C 1/08
351/106
- D343,182 S 1/1994 Jannard
- D356,323 S 3/1995 Yee
- D356,324 S 3/1995 Yee
- D359,302 S 6/1995 Yee et al.
- D359,748 S 6/1995 Yee
- D359,749 S 6/1995 Yee
- D377,498 S 1/1997 Jannard et al.
- D380,766 S 7/1997 Simioni
- D397,132 S 8/1998 Yee
- D401,607 S 11/1998 Miniutti
- D409,222 S 5/1999 Raub
- D423,034 S 4/2000 Arnette
- D427,622 S 7/2000 Conway

(Continued)

OTHER PUBLICATIONS

U.S. Appl. No. 29/471,296, filed Oct. 30, 2013, Yoo.
(Continued)

Primary Examiner — Susan Moon Lee
(74) *Attorney, Agent, or Firm* — Knobbe Martens Olson & Bear, LLP

(57) **CLAIM**
The ornamental design for eyeglasses, as shown and described.

(56) **References Cited**

U.S. PATENT DOCUMENTS

- D150,924 S 9/1948 Bright
- D158,963 S 6/1950 Jonassen
- D175,555 S * 9/1955 Kono D16/323
- D202,658 S 10/1965 Petitto
- D209,237 S 11/1967 Kono
- 3,402,005 A * 9/1968 Liautaud G02C 5/00
351/111
- 3,476,466 A 11/1969 Hopkins
- D218,569 S 9/1970 Mccracken
- 3,582,194 A * 6/1971 Liautaud G02C 3/003
16/228
- 4,196,982 A * 4/1980 Watkins G02C 1/06
2/443
- D268,683 S 4/1983 Tenny
- D320,402 S 10/1991 Jannard et al.

DESCRIPTION

FIG. 1 is a front perspective view of eyeglasses showing an embodiment of the new design;
FIG. 2 is a front elevational view thereof;
FIG. 3 is a rear elevational view thereof;
FIG. 4 is a left side elevational view thereof, the right side elevational view being a mirror image thereof;
FIG. 5 is a top plan view thereof; and,
FIG. 6 is a bottom plan view thereof.
The broken lines in the Figures show portions of the eyeglasses which form no part of the claimed design.

1 Claim, 4 Drawing Sheets

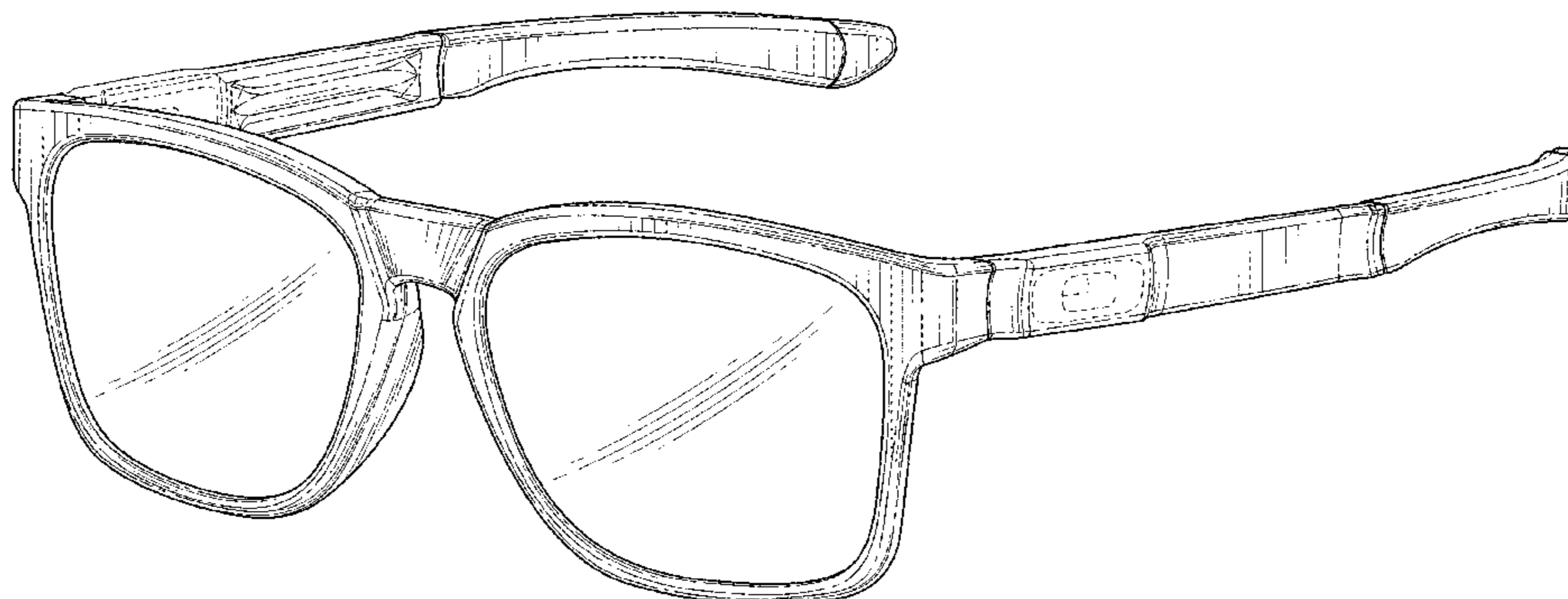

(56)

References Cited

U.S. PATENT DOCUMENTS

6,099,117 A * 8/2000 Gregory G02C 5/22
351/153

D500,781 S 1/2005 Mage
D536,027 S 1/2007 Paulson
D536,363 S 2/2007 Miklitarian
D539,833 S 4/2007 Chuang
D543,572 S 5/2007 Yee et al.
D545,348 S 6/2007 Chen
D549,764 S 8/2007 Teng
D553,176 S 10/2007 Yee et al.
D575,324 S 8/2008 Moritz
D577,759 S 9/2008 Yee
D581,449 S 11/2008 Yee
D581,450 S 11/2008 Moritz
D590,432 S 4/2009 Yee
D599,836 S 9/2009 Rohrbach
D599,838 S 9/2009 Rohrbach
D599,839 S 9/2009 Rohrbach
D601,613 S 10/2009 Yee
D604,758 S 11/2009 Rohrbach et al.
D604,759 S 11/2009 Rohrbach et al.
D607,040 S 12/2009 Rohrbach
D615,580 S 5/2010 Baden et al.
D621,438 S 8/2010 Markovitz et al.
D622,755 S 8/2010 Yee
D623,217 S 9/2010 Markovitz et al.
D629,444 S 12/2010 Akarra et al.
D640,727 S 6/2011 Moritz et al.
8,020,988 B2 9/2011 Ogren et al.
D648,772 S 11/2011 Shin et al.
D650,825 S 12/2011 Yee et al.
D652,442 S 1/2012 Yee et al.
D653,699 S 2/2012 Shin
D654,530 S 2/2012 Markovitz et al.
D654,947 S 2/2012 Shin et al.

D659,182 S * 5/2012 Shin D16/326
D661,340 S * 6/2012 Kim D16/309
D662,536 S 6/2012 Shin
D662,967 S 7/2012 Shin
D664,590 S 7/2012 Shin
8,240,846 B2 8/2012 Ogren et al.
D675,666 S 2/2013 Thixton et al.
D676,480 S 2/2013 Shin
D676,898 S 2/2013 Shin et al.
D678,389 S 3/2013 Rohrbach
D680,574 S * 4/2013 DeCelles D16/309
D700,933 S * 3/2014 Shin D16/326
D702,757 S 4/2014 Thixton et al.
D703,260 S 4/2014 Yoo
D707,284 S 6/2014 Yoo
D709,122 S * 7/2014 Markovitz D16/326
D711,958 S 8/2014 Yoo
D714,858 S 10/2014 Thixton
D718,371 S * 11/2014 Morton D16/326
D718,372 S * 11/2014 Markovitz D16/326
D720,799 S 1/2015 Thixton
D720,800 S 1/2015 Shin
D734,808 S * 7/2015 Markovitz D16/326
D737,886 S * 9/2015 Markovitz D16/326

OTHER PUBLICATIONS

U.S. Appl. No. 29/477,328, filed Dec. 20, 2013, Yoo.
U.S. Appl. No. 29/477,377, filed Dec. 20, 2013, Thixton.
U.S. Appl. No. 29/507,142, filed Oct. 24, 2014, Shin.
U.S. Appl. No. 29/509,141, filed Nov. 14, 2014, Garfias.
U.S. Appl. No. 29/509,142, filed Nov. 14, 2014, Yoo.
U.S. Appl. No. 29/509,137, filed Nov. 14, 2014, Yoo.
U.S. Appl. No. 29/509,138, filed Nov. 14, 2014, Thixton.
U.S. Appl. No. 29/509,136, filed Nov. 14, 2014, Thixton.
Oakley, Inc. Website (HJ26003164), published around Oct. 2013, in
1 page.

* cited by examiner

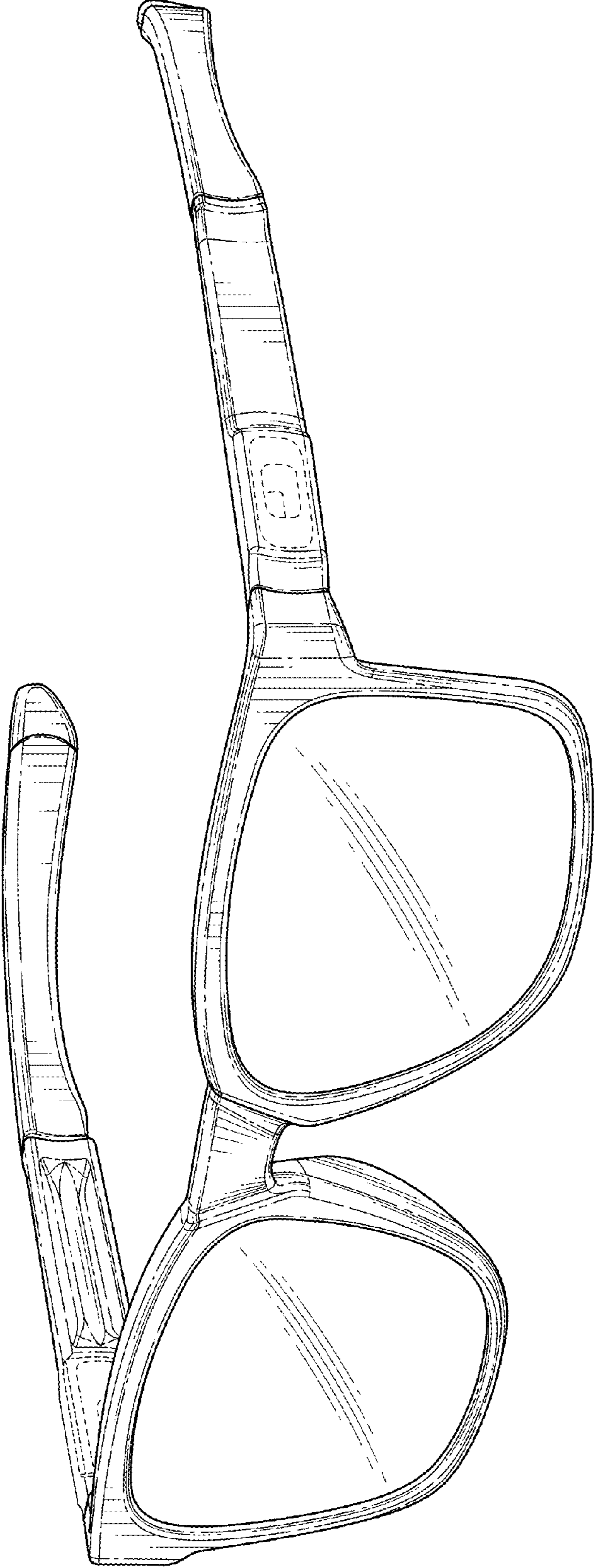

FIG. 1

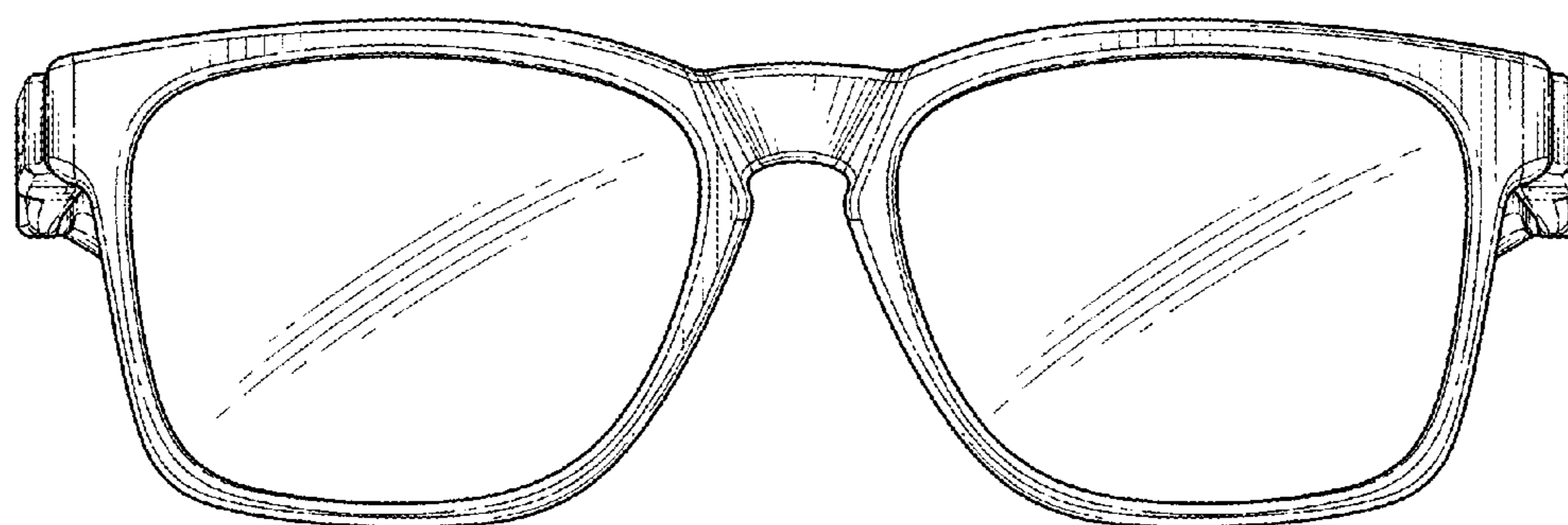

FIG. 2

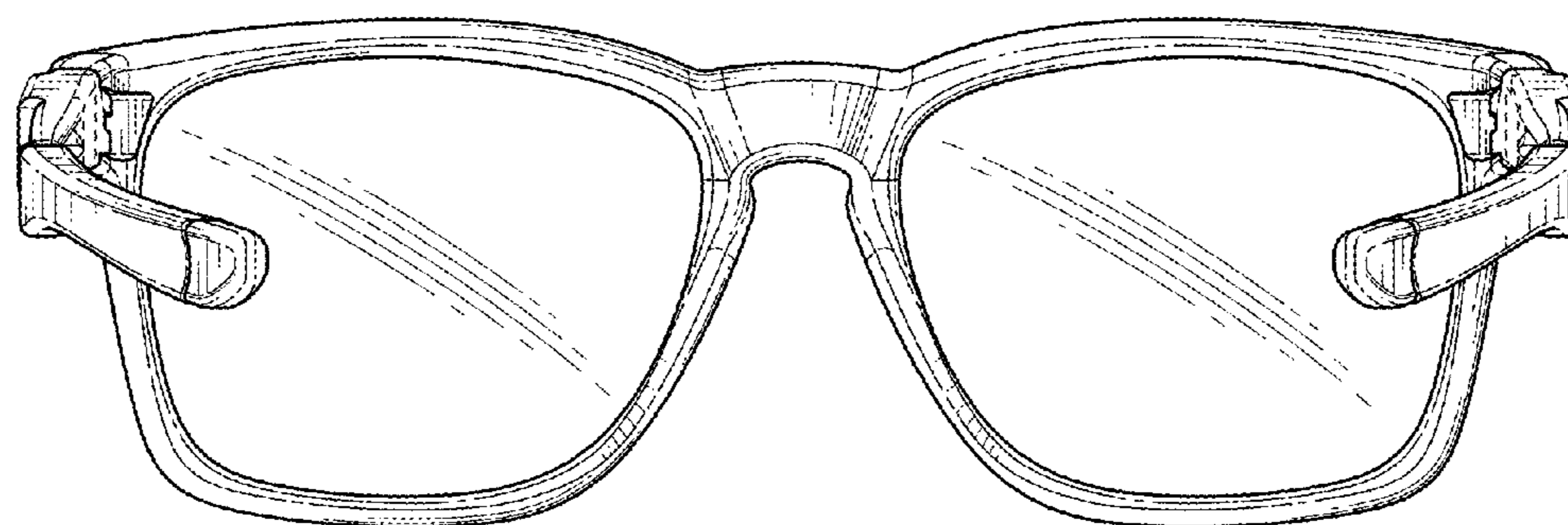

FIG. 3

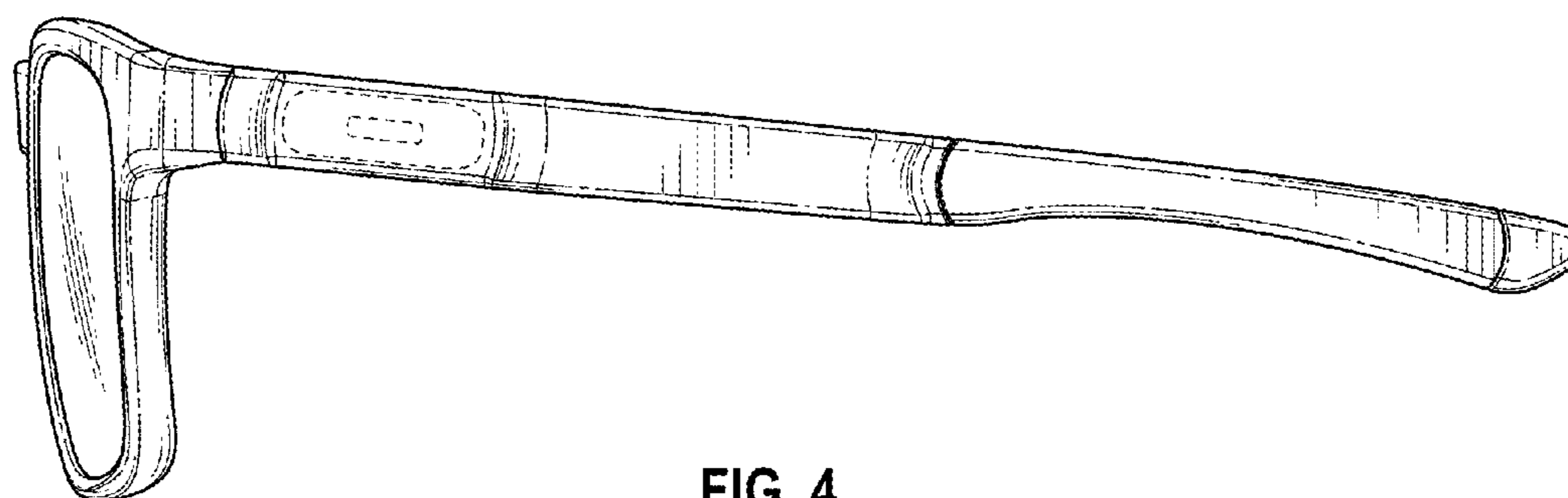

FIG. 4

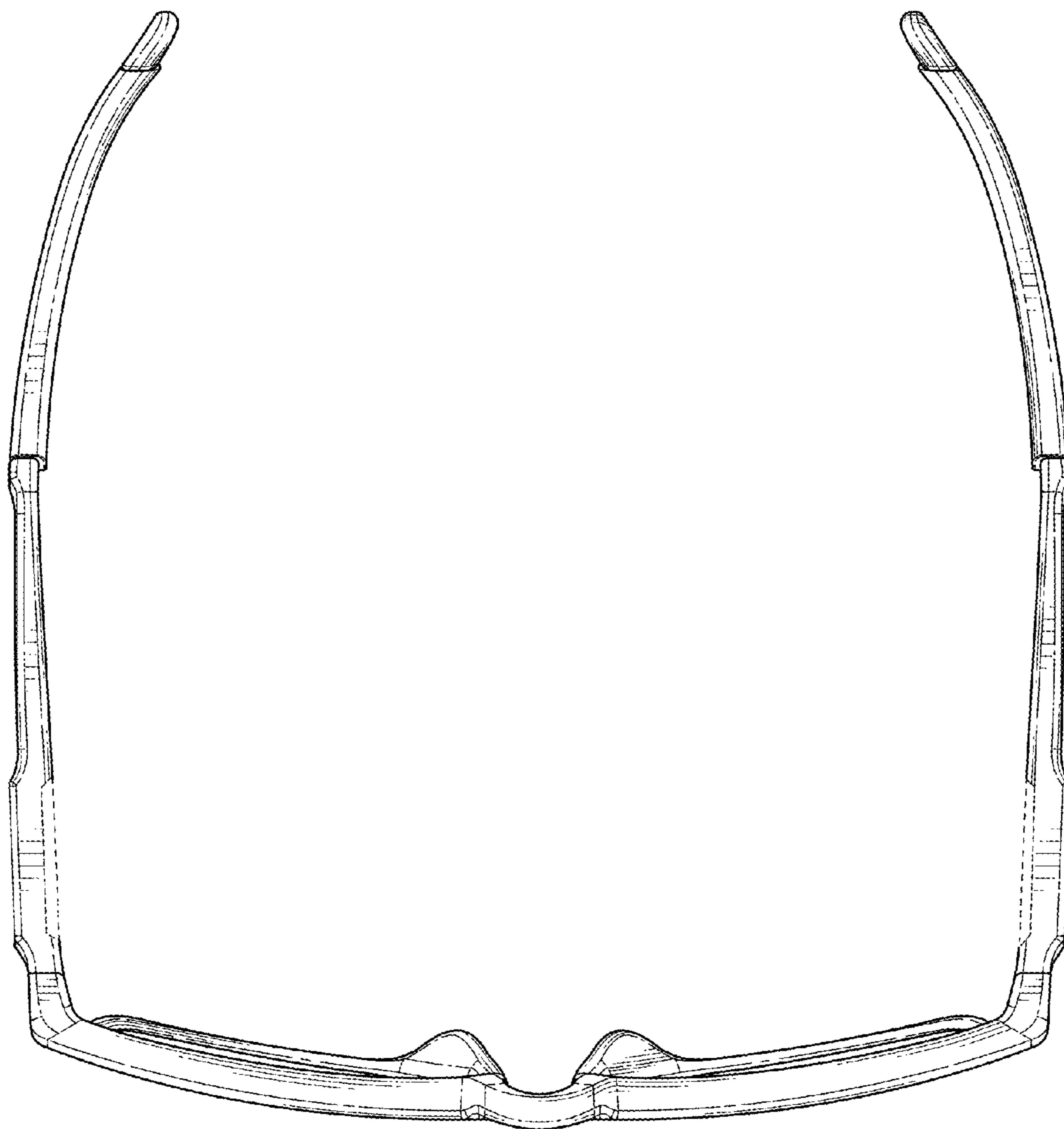

FIG. 5

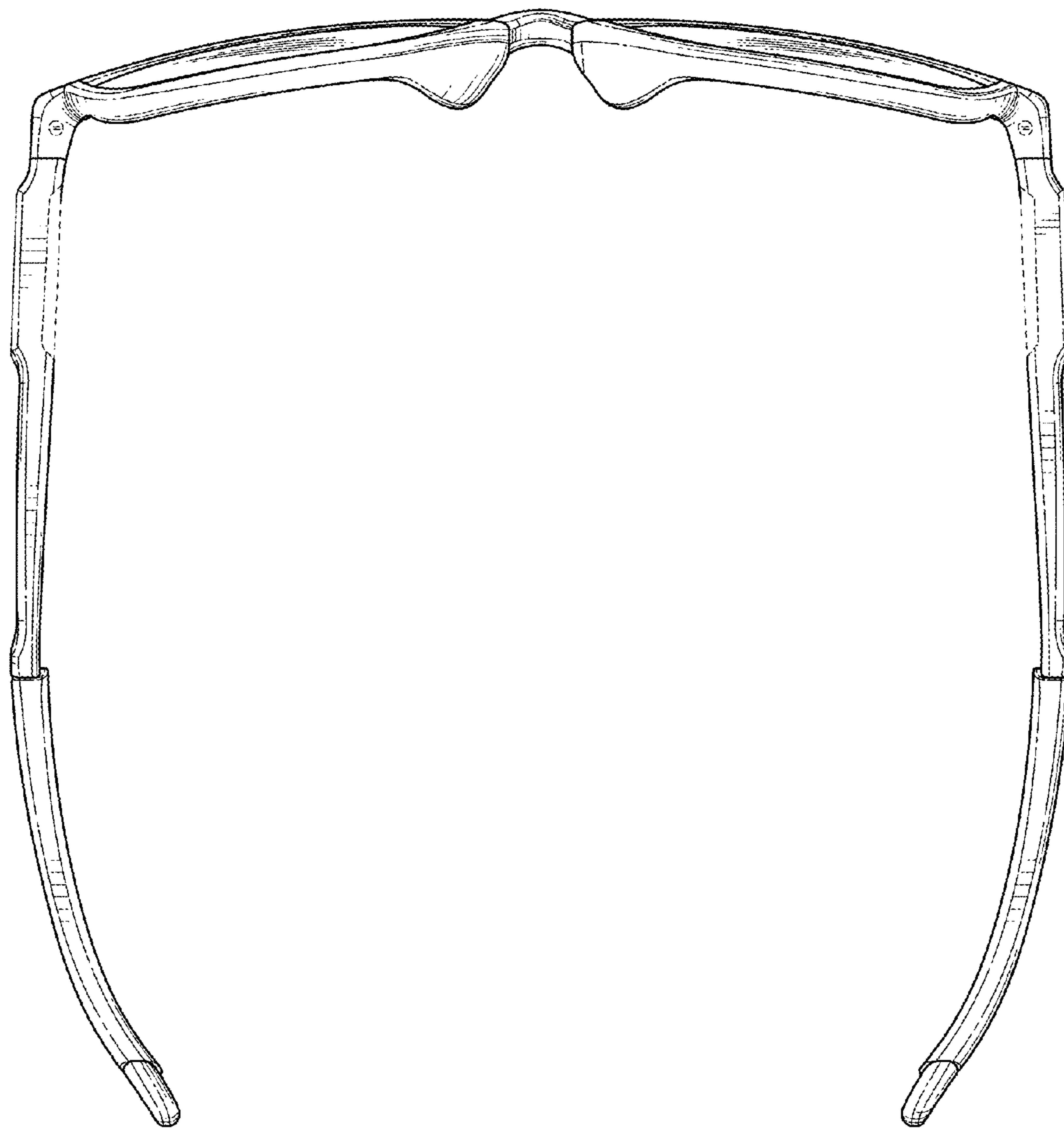

FIG. 6