



US00D748126S

(12) **United States Design Patent**
Sarukkai et al.

(10) **Patent No.:** **US D748,126 S**
(45) **Date of Patent:** **** Jan. 26, 2016**

(54) **DISPLAY SCREEN WITH A GRAPHICAL USER INTERFACE FOR CLOUD USAGE ANALYSIS**

D719,968 S * 12/2014 Ebtakar D14/486
D733,178 S * 6/2015 Omiya D14/486
D737,840 S * 9/2015 Omiya D14/486
2009/0210813 A1 * 8/2009 Sawczak G06F 1/206
715/771
2014/0028682 A1 * 1/2014 Omiya G09G 5/363
345/440

(71) Applicant: **Skyhigh Networks, Inc.**, Cupertino, CA (US)

* cited by examiner

(72) Inventors: **Sekhhar Sarukkai**, Cupertino, CA (US);
Kaushik Narayan, San Jose, CA (US);
Rajiv Gupta, Los Altos, CA (US);
Dejan Curcic, San Jose, CA (US);
Christopher M. Guidroz, London (GB)

Primary Examiner — Cathron Brooks
(74) *Attorney, Agent, or Firm* — Van Pelt, Yi & James LLP

(73) Assignee: **Skyhigh Networks, Inc.**, Campbell, CA (US)

(57) **CLAIM**
We claim the ornamental design for a display screen with a graphical user interface for cloud usage analysis, as shown and described.

(**) Term: **14 Years**

DESCRIPTION

(21) Appl. No.: **29/477,584**

A portion of the disclosure of this patent document contains material to which a claim for copyright and trademark is made. The copyright and trademark owner has no objection to the reproduction by anyone of the patent document or the patent disclosure, as it appears in the U.S. Patent and Trademark Office patent file or records, but reserves all other copyrights and trademark rights whatsoever.

(22) Filed: **Dec. 23, 2013**

(51) **LOC (10) Cl.** **14-04**

(52) **U.S. Cl.**
USPC **D14/486**

(58) **Field of Classification Search**
USPC D14/485-488; 715/212-220, 777, 779, 715/792, 702; 705/37
CPC G06F 17/30115; G06F 3/0481; G06F 3/0482; G06F 3/0483; H04N 1/00408; H04M 1/2477; H04M 1/274558
See application file for complete search history.

FIG. 1 is a front view of a first embodiment of a display screen with a graphical user interface for cloud usage analysis showing our new design.

FIG. 2 is a front view of a second embodiment thereof.

FIG. 3 is a front view of a third embodiment thereof.

FIG. 4 is a front view of a fourth embodiment thereof.

FIG. 5 is a front view of a fifth embodiment thereof; and,

FIG. 6 is a front view of a sixth embodiment thereof.

The broken line on the outer boundary of the figures illustrates a display screen and forms no part of the claimed design. All broken lines within the graphical user interface illustrate portions of the display screen with graphical user interface, and form no part of the claimed design.

(56) **References Cited**

U.S. PATENT DOCUMENTS

D420,340 S * 2/2000 Bailer D14/486
7,248,263 B2 * 7/2007 Freeman G06T 11/206
345/440
D640,264 S * 6/2011 Fujii D14/486
D681,651 S * 5/2013 Fletcher D14/485

1 Claim, 6 Drawing Sheets

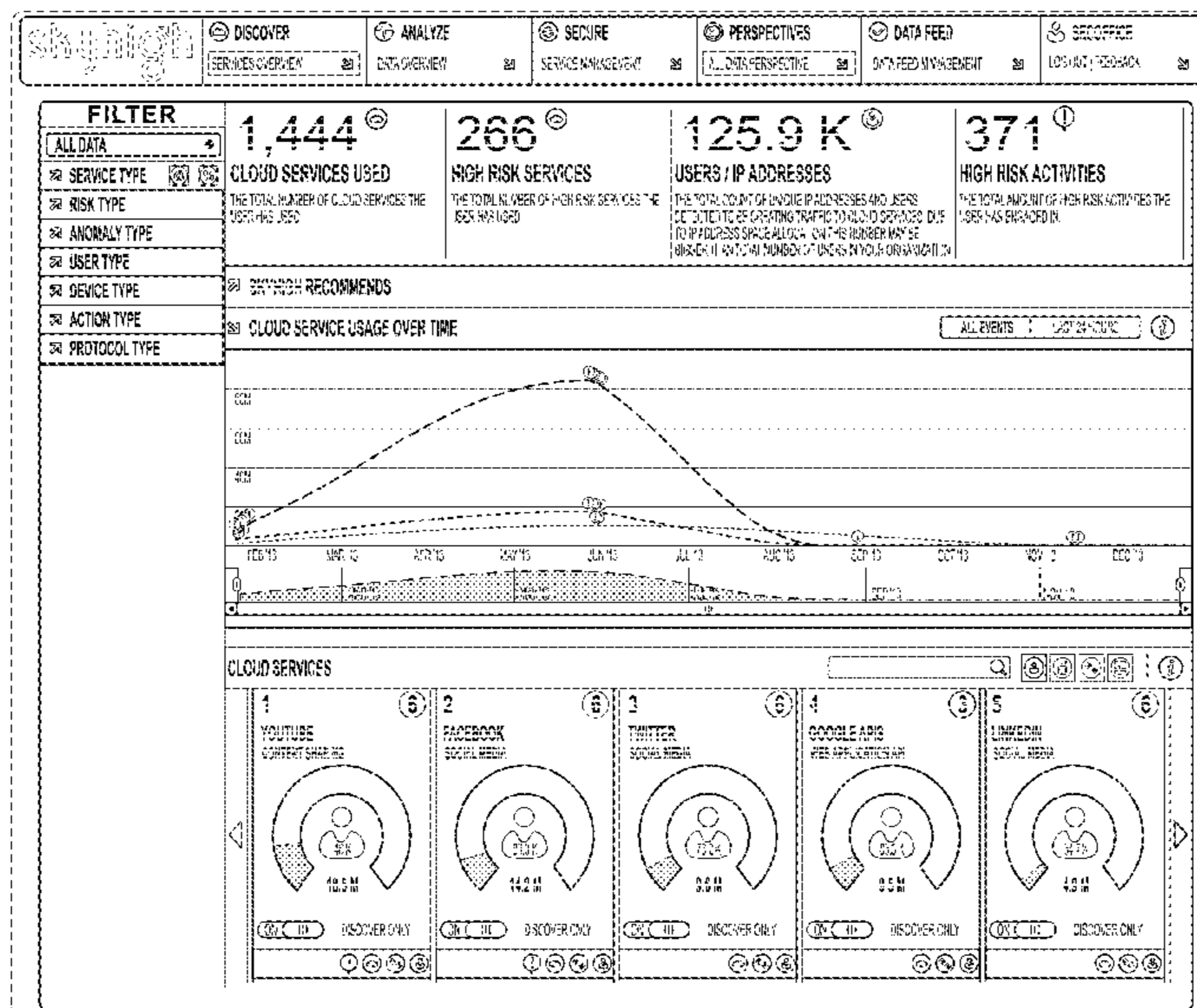

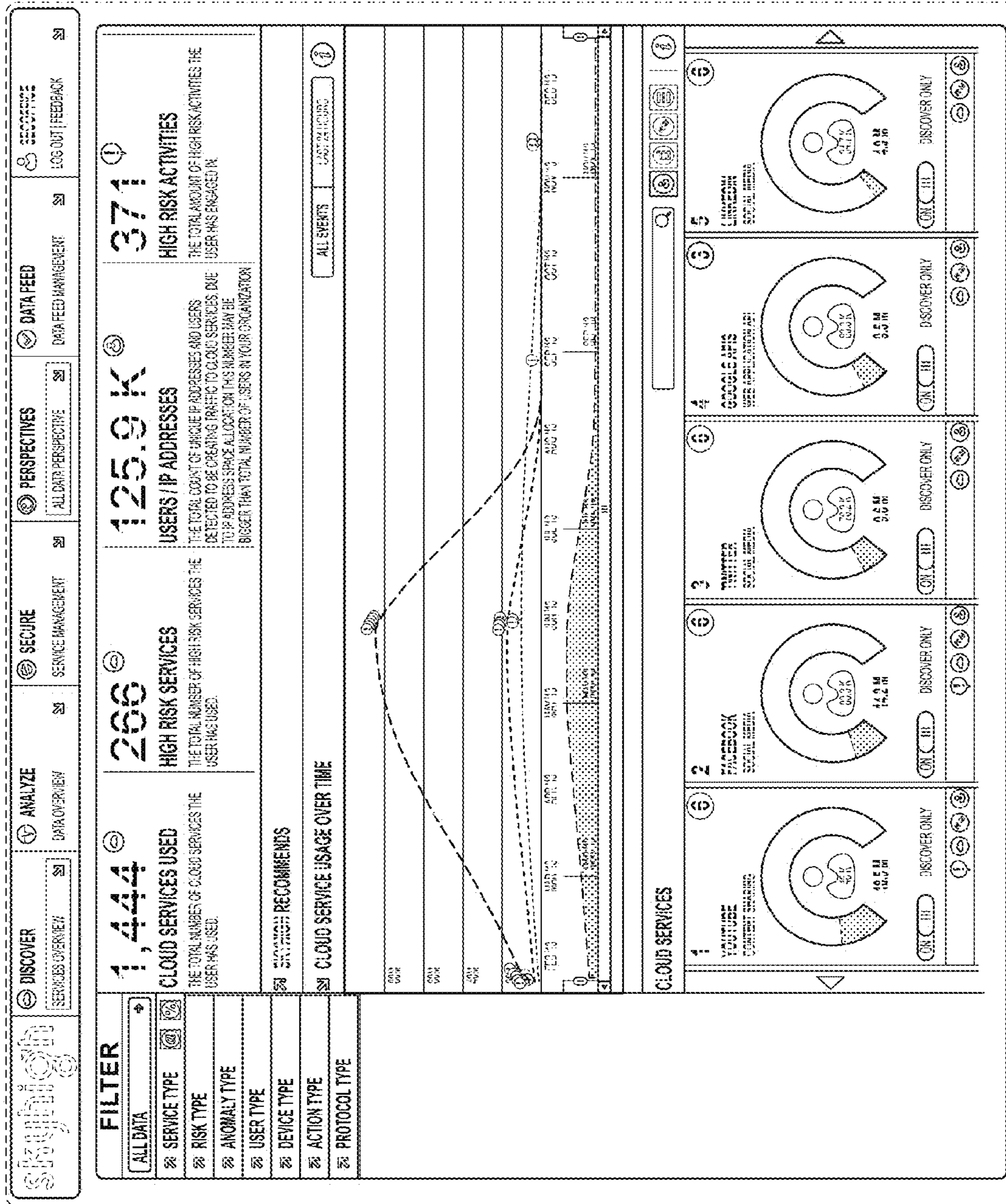

FIG. 1

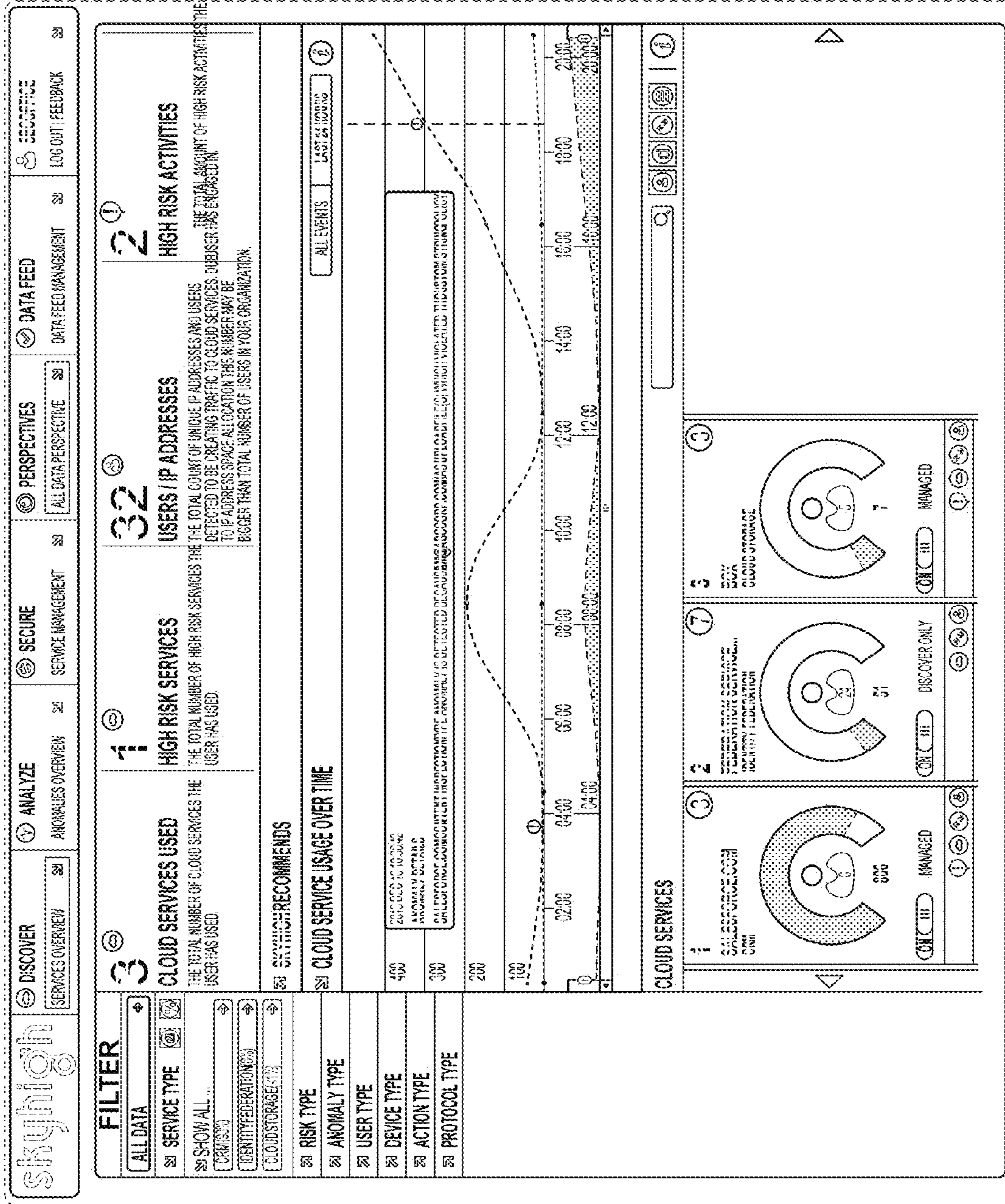

FIG. 2

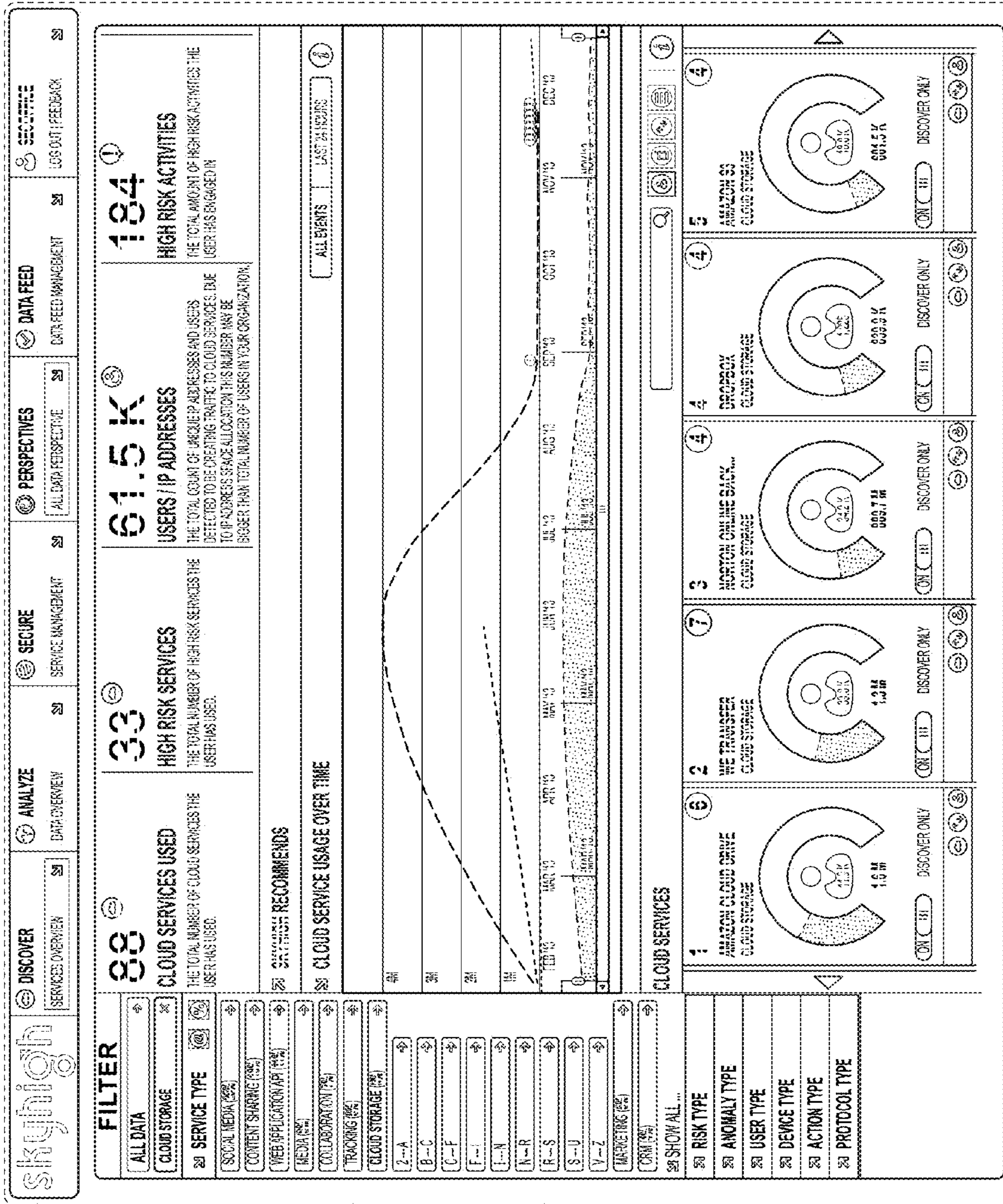

FIG. 3

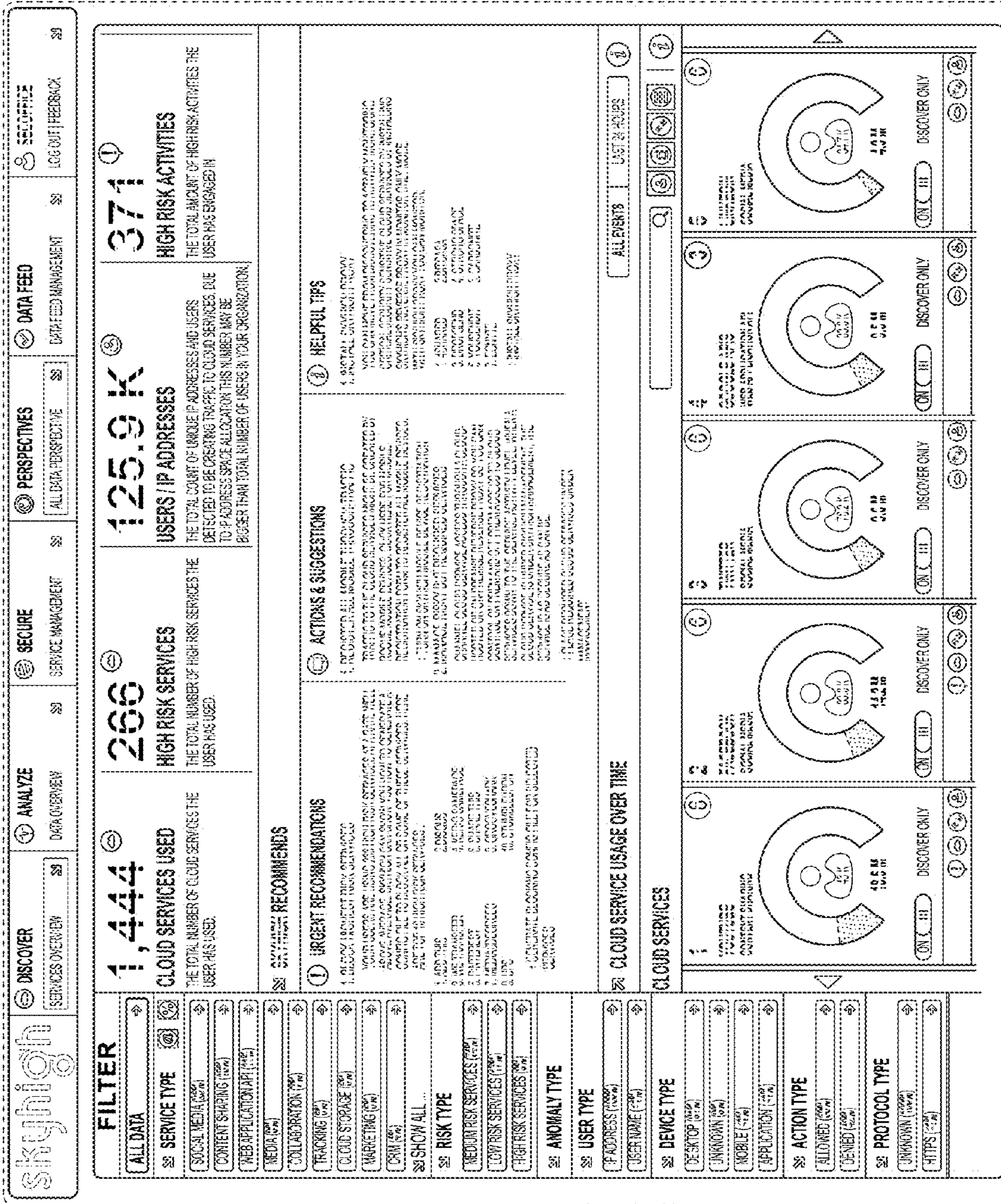

FIG. 4

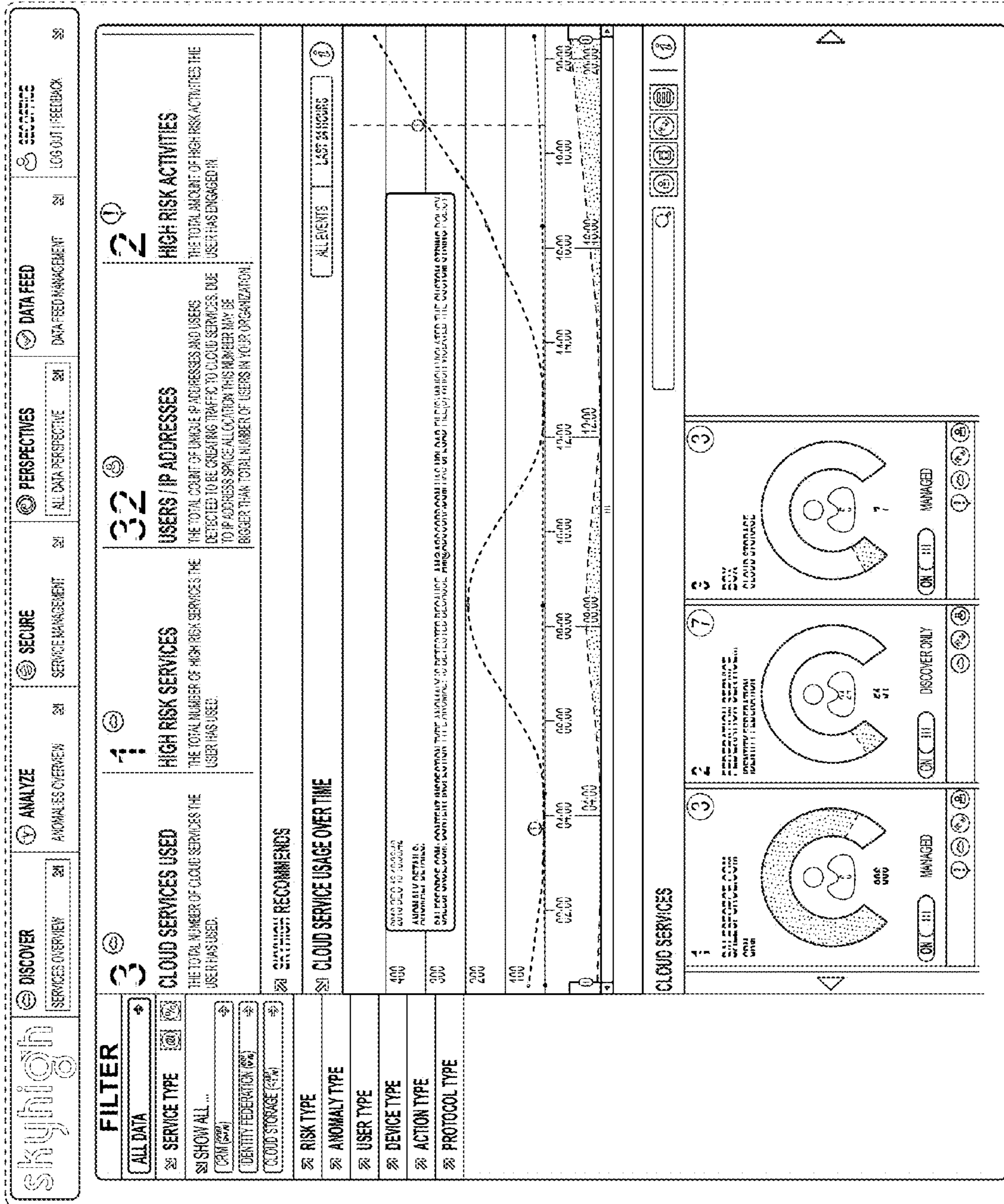

FIG. 5

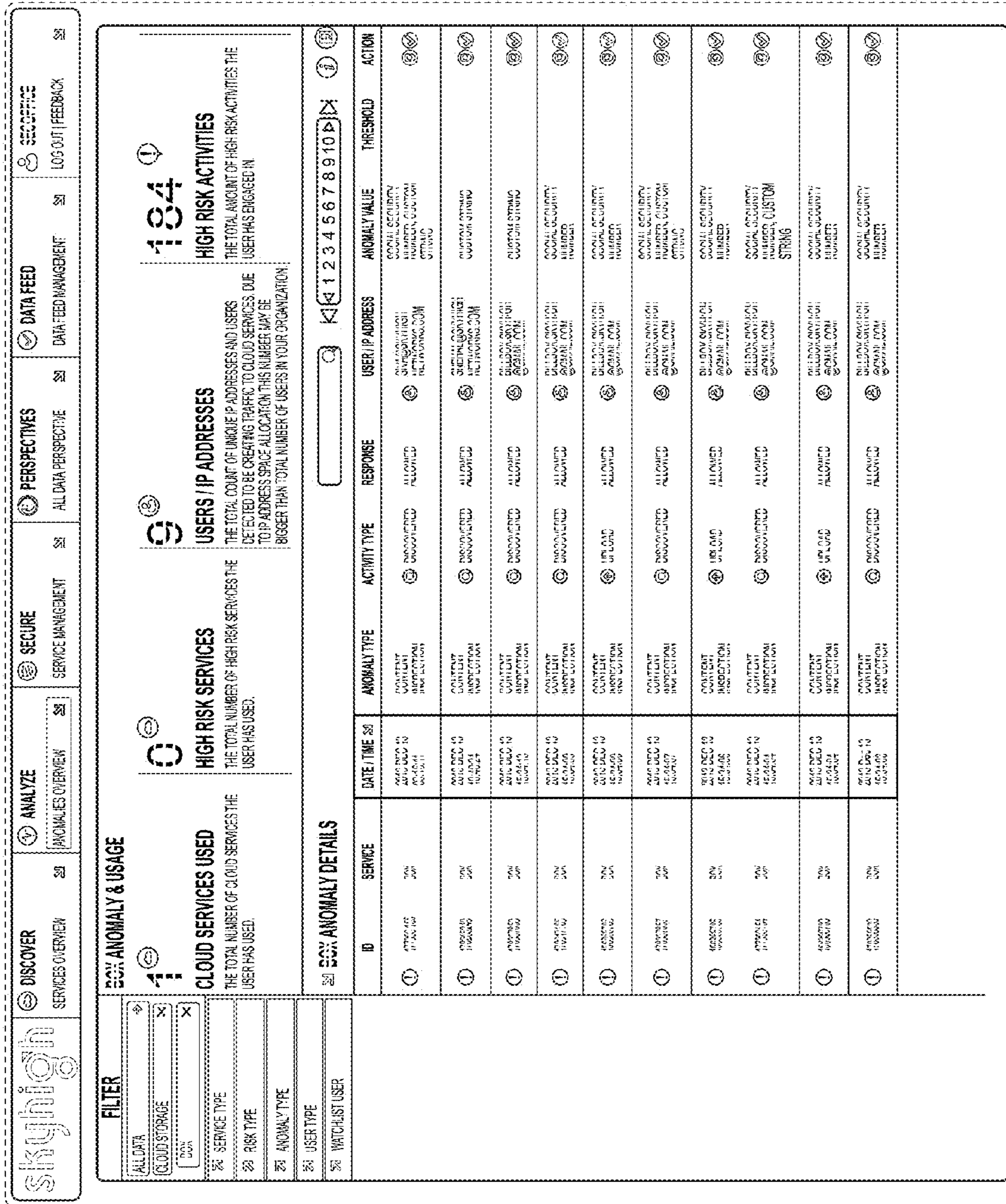

FIG. 6