



US00D748097S

(12) **United States Design Patent**
Feng

(10) **Patent No.:** **US D748,097 S**
(45) **Date of Patent:** **** Jan. 26, 2016**

(54) **TABLET CASE**

(71) Applicant: **Youru Feng**, Guangzhou (CN)

(72) Inventor: **Youru Feng**, Guangzhou (CN)

(**) Term: **14 Years**

(21) Appl. No.: **29/500,593**

(22) Filed: **Aug. 26, 2014**

(30) **Foreign Application Priority Data**

Jul. 25, 2014 (CN) 2014 3 0256244

(51) **LOC (10) Cl.** **14-02**

(52) **U.S. Cl.**
USPC **D14/440**

(58) **Field of Classification Search**
USPC D14/250, 251, 253, 240, 217, 496, 440,
D14/203.3, 203.4, 203.5, 203.8, 341, 318;
D3/218, 215, 201, 294, 289, 900;
220/4.02; 248/309.1; 361/679.56;
379/426, 433.11, 455; 455/575.1,
455/575.8, 457.1; 190/100; 206/305, 320,
206/45.2; D21/469; 312/240
CPC ... G06F 1/1601; G06F 1/1626; G06F 1/1633;
G06F 1/1675; G06F 1/1679; G02F 1/1306;
G02F 1/133; G02F 1/133308; G02F 1/153;
G02F 1/1533; G02F 2001/133317; H04M
1/185; H04M 1/0252; H04B 1/3888
See application file for complete search history.

(56) **References Cited**

U.S. PATENT DOCUMENTS

1,613,536 A * 1/1927 Rose 132/315
D118,197 S * 12/1939 Trussell D19/26
D230,376 S * 2/1974 Andrew D19/91
4,259,568 A * 3/1981 Dynesen 235/1 D
6,772,879 B1 * 8/2004 Domotor 206/45.23
7,281,698 B2 * 10/2007 Patterson, Jr. 248/458
7,414,833 B2 * 8/2008 Kittayapong 361/679.27
7,735,644 B2 * 6/2010 Sirichai et al. 206/320

D658,187 S * 4/2012 Diebel D14/440
D658,188 S * 4/2012 Diebel D14/440
D663,304 S * 7/2012 Akana et al. D14/440
8,230,992 B2 * 7/2012 Law et al. 206/320
8,245,843 B1 * 8/2012 Wu 206/320
8,312,991 B2 * 11/2012 Diebel et al. 206/45.24
D671,948 S * 12/2012 Akana et al. D14/440
D672,353 S * 12/2012 Liu D14/440
D672,781 S * 12/2012 Lu D14/440
D675,625 S * 2/2013 Hasbrook et al. D14/440
D678,260 S * 3/2013 Bau D14/250
D679,279 S * 4/2013 Yang et al. D14/440
D679,715 S * 4/2013 Akana et al. D14/440
8,424,830 B2 * 4/2013 Yang et al. 248/459
D681,641 S * 5/2013 Van Den Nieuwenhuizen
et al. D14/440
D682,836 S * 5/2013 Akana et al. D14/440
D682,838 S * 5/2013 Akana et al. D14/440
D683,141 S * 5/2013 Symons D6/310
D684,978 S * 6/2013 Phillips et al. D14/440

(Continued)

Primary Examiner — Cynthia Underwood

(74) *Attorney, Agent, or Firm* — Mintz Levin Cohn Ferris
Glovsky and Popeo, P.C.

(57) **CLAIM**

The ornamental design for a tablet case, as shown and
described.

DESCRIPTION

FIG. 1 is a Front View of the tablet case;
FIG. 2 is a Rear View thereof;
FIG. 3 is a Perspective View thereof,
FIG. 4 is a Perspective View in USE stage thereof,
FIG. 5 is a Perspective View thereof,
FIG. 6 is a Perspective View thereof; and,
FIG. 7 is a Perspective View thereof.
In the figures, the long-segmented broken lines represent
stitching that is not part of the claimed design. The short-
segmented broken lines show a plurality of grooves that also
do not form part of the claimed design. The plurality of
grooves is configured to support and hold an inner case of the
tablet case.

1 Claim, 7 Drawing Sheets

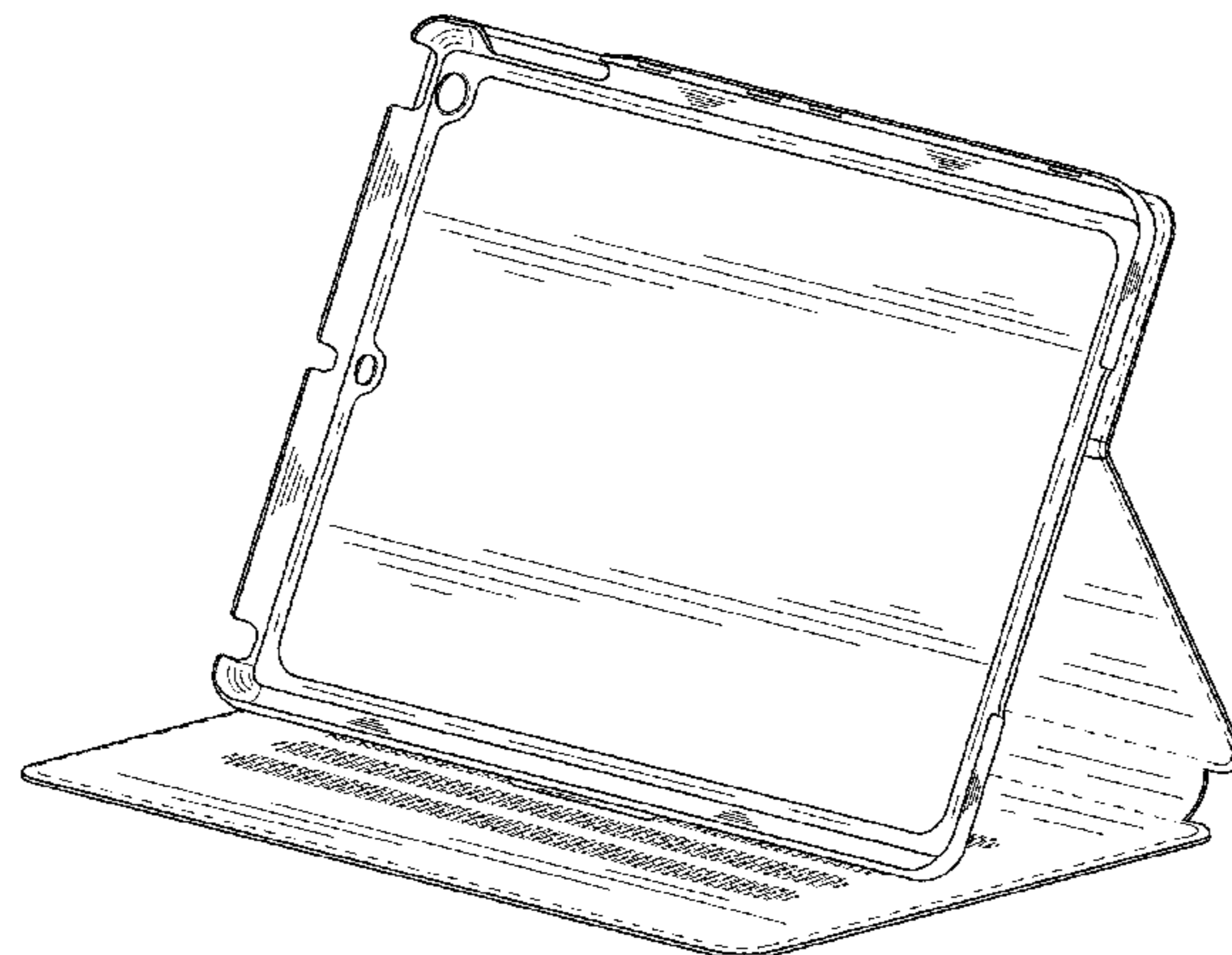

(56)

References Cited

U.S. PATENT DOCUMENTS

D686,629 S *	7/2013	Trinh et al.	D14/447	8,763,795 B1 *	7/2014	Oten et al.	206/45.23
D687,438 S *	8/2013	Lu	D14/440	8,766,921 B2 *	7/2014	Ballagas et al.	345/168
D688,250 S *	8/2013	Phillips et al.	D14/440	8,773,353 B2 *	7/2014	Wei	345/156
D690,305 S *	9/2013	Wen	D14/440	8,783,458 B2 *	7/2014	Gallagher et al.	206/320
D690,702 S *	10/2013	Chung	D14/440	D710,859 S *	8/2014	Mecchella et al.	D14/440
D691,142 S *	10/2013	Diebel	D14/440	8,797,132 B2 *	8/2014	Childs et al.	335/219
D692,434 S *	10/2013	Kim	D14/440	D723,570 S *	3/2015	Sirichai	D14/440
D693,823 S *	11/2013	Chen et al.	D14/440	D724,595 S *	3/2015	Sirichai	D14/440
D695,296 S *	12/2013	Hsu	D14/440	D724,596 S *	3/2015	Sirichai	D14/440
D696,253 S *	12/2013	Akana et al.	D14/345	2003/0034263 A1 *	2/2003	D'Hoste	206/320
D696,256 S *	12/2013	Piedra et al.	D14/440	2008/0302687 A1 *	12/2008	Sirichai et al.	206/320
D696,669 S *	12/2013	Akana et al.	D14/440	2009/0159763 A1 *	6/2009	Kim	248/174
8,640,864 B2 *	2/2014	Chen et al.	206/45.2	2011/0266194 A1 *	11/2011	Bau	206/736
8,644,893 B2 *	2/2014	Liang	455/575.1	2011/0290687 A1 *	12/2011	Han	206/320
8,657,112 B2 *	2/2014	Igarashi	206/320	2012/0091312 A1 *	4/2012	Baker	248/682
D701,205 S *	3/2014	Akana et al.	D14/345	2012/0211377 A1 *	8/2012	Sajid	206/216
D702,673 S *	4/2014	Murchison et al.	D14/250	2012/0211613 A1 *	8/2012	Yang et al.	248/174
D704,689 S *	5/2014	Chang	D14/250	2012/0305413 A1 *	12/2012	Chung	206/45.23
D704,693 S *	5/2014	Kim	D14/250	2012/0308981 A1 *	12/2012	Libin et al.	434/362
D706,270 S *	6/2014	Akana et al.	D14/440	2013/0015088 A1 *	1/2013	Wu	206/320
D706,783 S *	6/2014	Almodova	D14/440	2013/0020216 A1 *	1/2013	Chiou	206/320
D707,229 S *	6/2014	Almodova	D14/440	2013/0140203 A1 *	6/2013	Chiang	206/320
8,757,375 B2 *	6/2014	Huang	206/320	2013/0213838 A1 *	8/2013	Tsai et al.	206/320
D708,838 S *	7/2014	Lee	D3/201	2013/0214661 A1 *	8/2013	McBroom	312/325
				2013/0241381 A1 *	9/2013	Hyneczek et al.	312/240
				2013/0264459 A1 *	10/2013	McCosh et al.	248/688

* cited by examiner



FIG.1

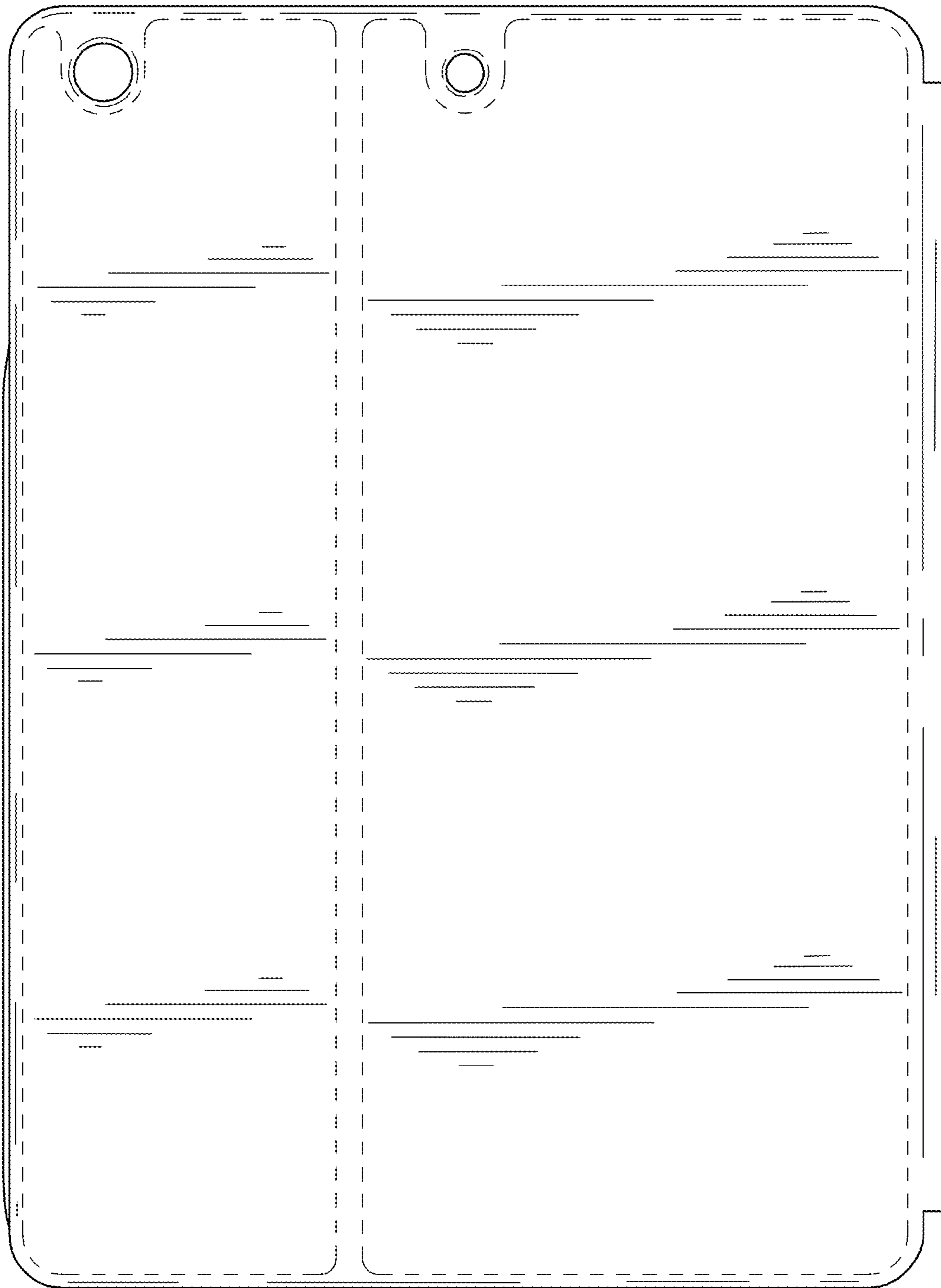

FIG. 2

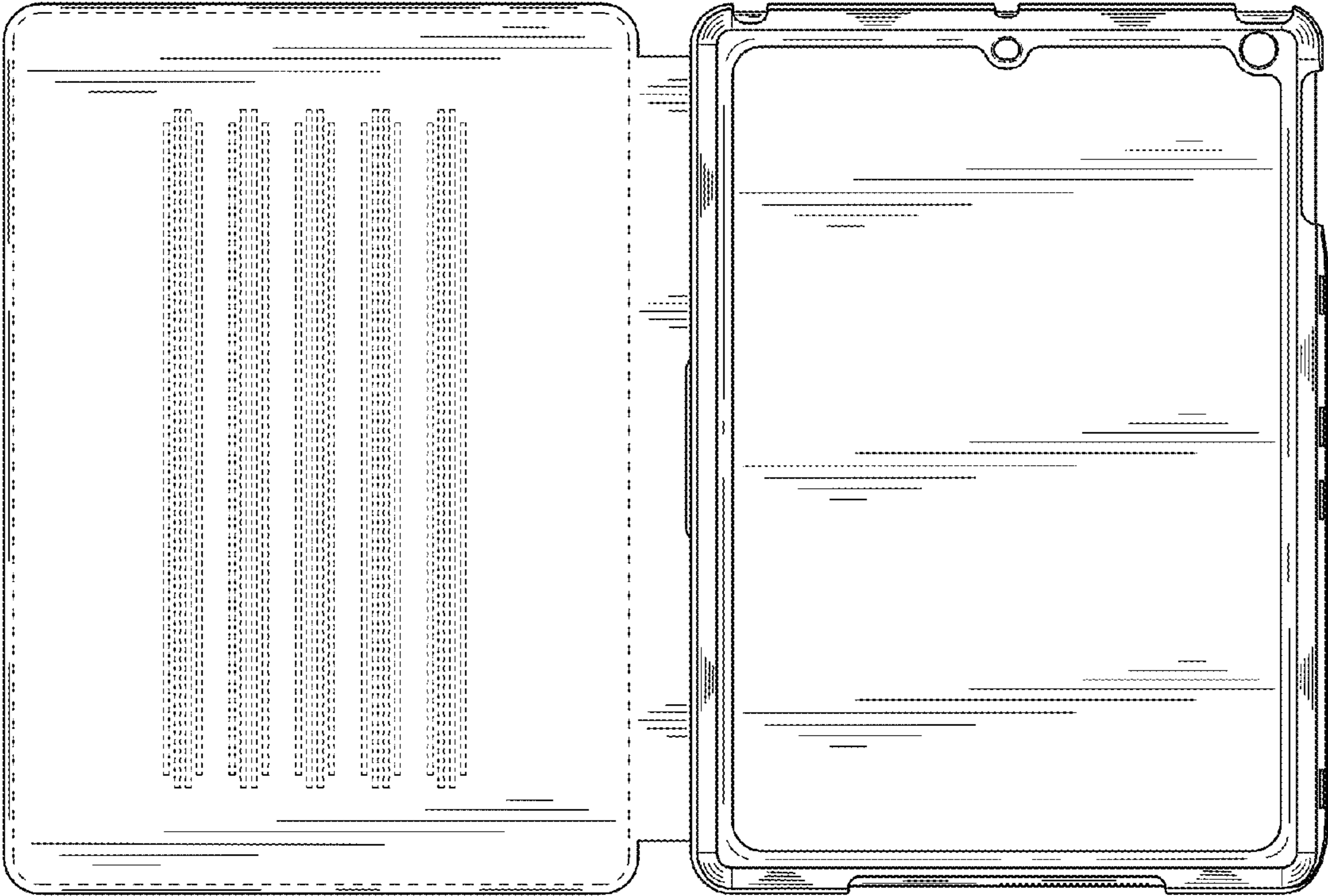

FIG.3

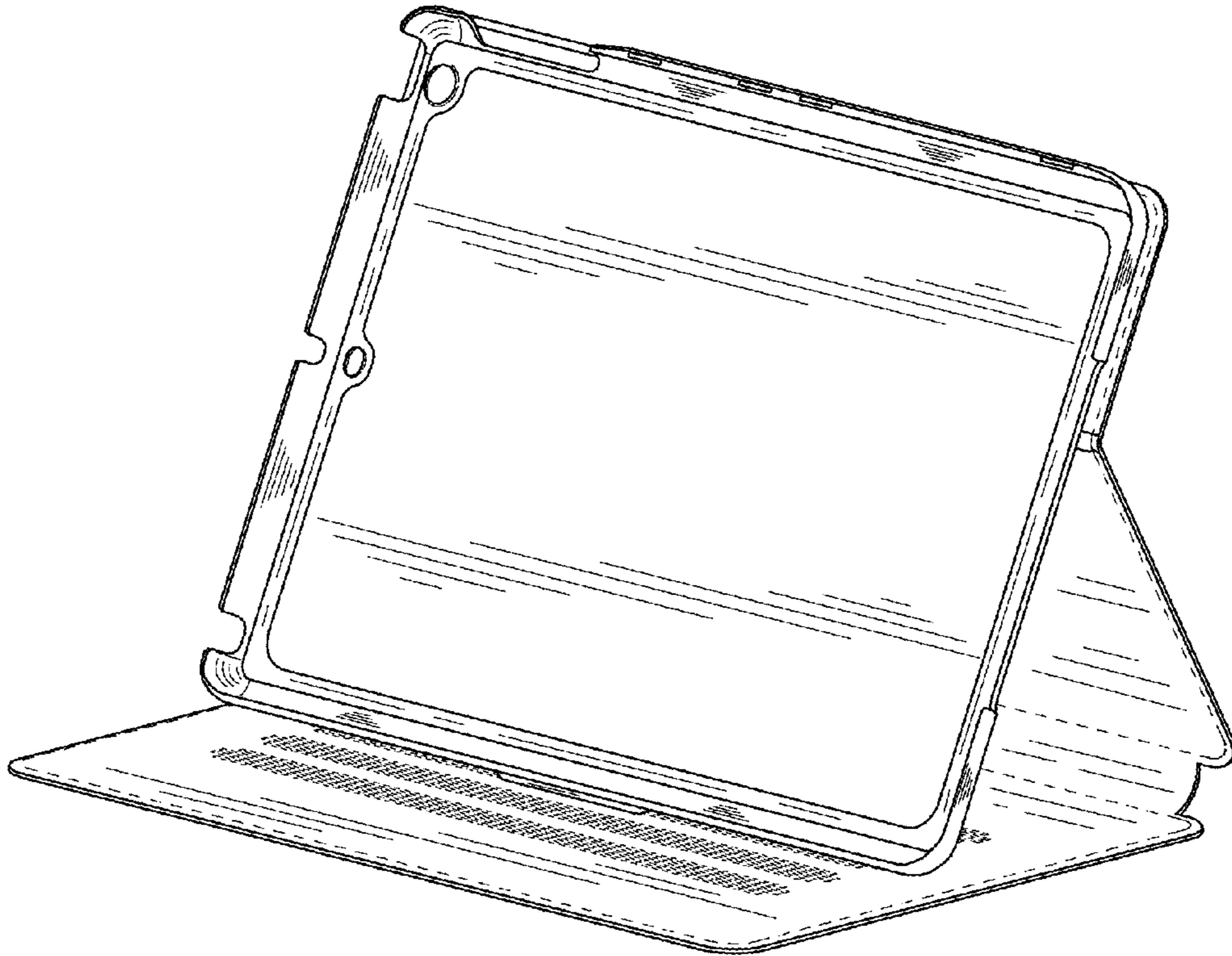

FIG.4

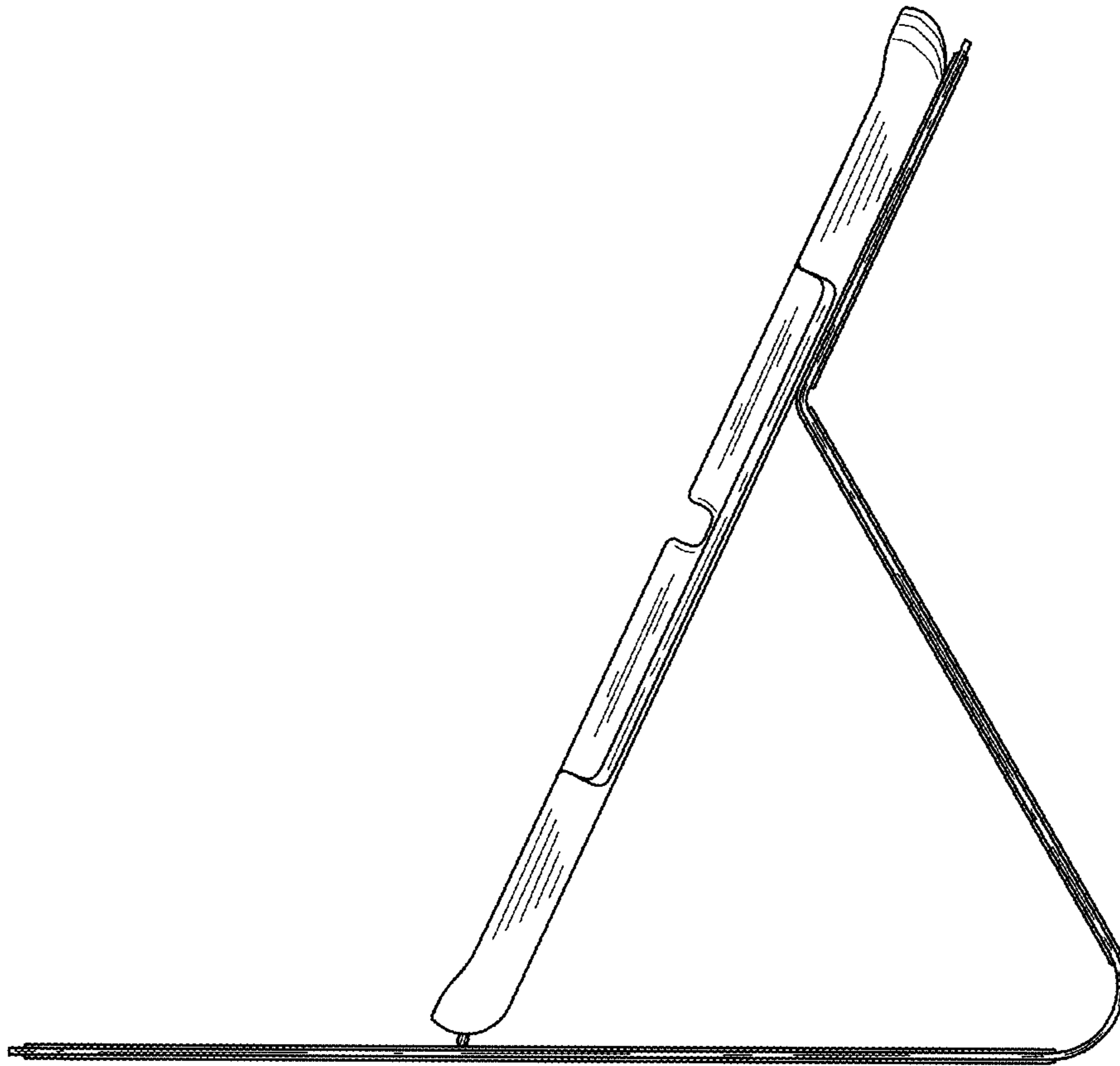

FIG.5

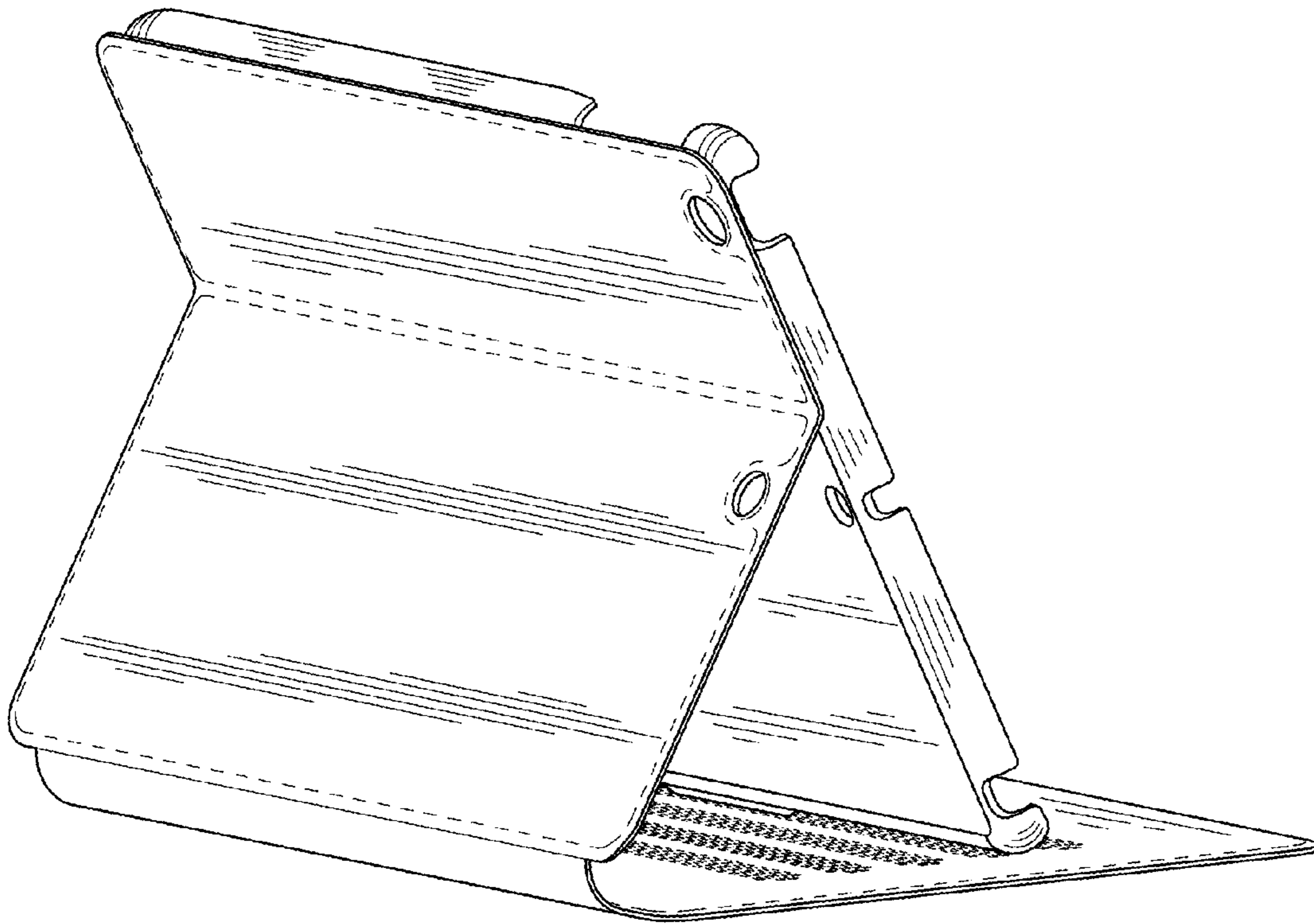

FIG.6

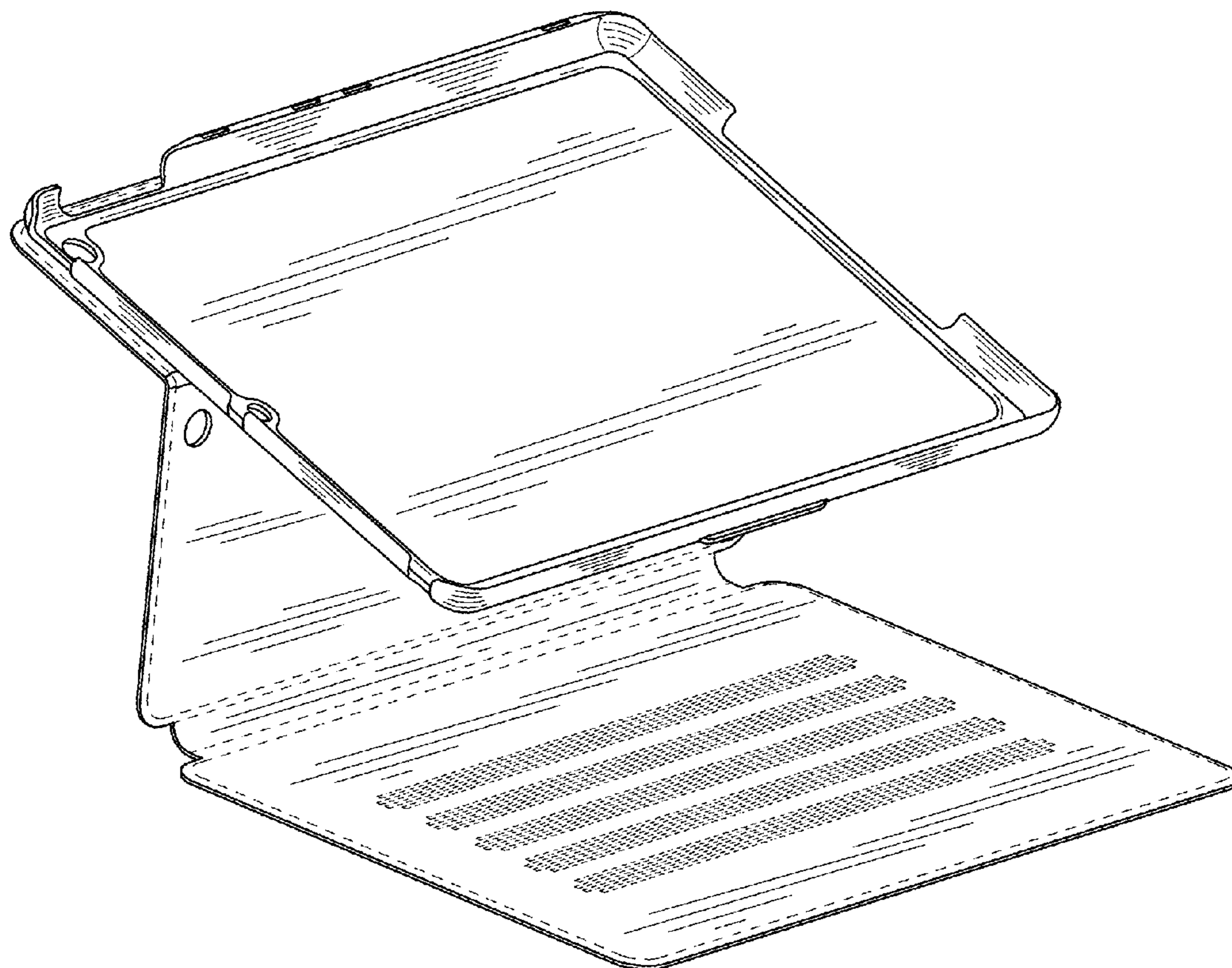

FIG.7