



US00D748092S

(12) **United States Design Patent**
Fujimoto et al.

(10) **Patent No.:** **US D748,092 S**
(45) **Date of Patent:** **** Jan. 26, 2016**

(54) **PERSONAL COMPUTER**

(71) Applicant: **FUJITSU LIMITED**, Kawasaki-shi,
Kanagawa (JP)

(72) Inventors: **Masahiro Fujimoto**, Tokyo (JP); **Ichiro
Itano**, Chigasaki (JP); **Yuki Iida**,
Yokohama (JP)

(73) Assignee: **FUJITSU LIMITED**, Kawasaki (JP)

(**) Term: **14 Years**

(21) Appl. No.: **29/485,700**

(22) Filed: **Mar. 21, 2014**

(30) **Foreign Application Priority Data**

Sep. 27, 2013 (JP) 2013-022528

(51) **LOC (10) Cl.** **14-02**

(52) **U.S. Cl.**
USPC **D14/341**

(58) **Field of Classification Search**

USPC D14/315-318, 341-344, 129, 130, 496,
D14/137, 138 R, 138 AA, 138 C, 138 G, 147,
D14/203.1, 203.3, 203.4, 203.7, 247, 389;
D6/300-302, 308, 310; D18/6, 7;
D21/324, 329, 330, 332; 455/556.2,
455/566; 379/916, 433.04, 433.1; 345/901,
345/905, 173; 361/679.26, 679.3, 679.55,
361/679.56

CPC H04M 1/0202; H04M 1/0279; H04M
1/0281; H04M 1/0283; G06F 1/1613; G06F
15/00; A63H 33/3016; G01S 17/74; G01S
17/08

See application file for complete search history.

(56) **References Cited**

U.S. PATENT DOCUMENTS

6,426,870 B1 * 7/2002 Oross et al. 361/679.55
D540,203 S * 4/2007 Jeon D10/65

D630,182 S * 1/2011 Park et al. D14/138 AA
D659,692 S * 5/2012 Jung et al. D14/341
D663,281 S * 7/2012 Hwang D14/138 G
D663,298 S * 7/2012 Song et al. D14/341
D664,540 S * 7/2012 Kim et al. D14/341
D671,514 S * 11/2012 Kim et al. D14/138 G
D672,346 S * 12/2012 Shen et al. D14/341
D678,270 S * 3/2013 Song et al. D14/341
D681,582 S * 5/2013 Park D14/138 G
D689,481 S * 9/2013 Song et al. D14/341
D691,575 S * 10/2013 Park D14/138 AD
D691,980 S * 10/2013 Park D14/138 G

(Continued)

OTHER PUBLICATIONS

Fujitsu Stylistic Q704, available Apr. 27, 2014, [online], [site visited
May 19, 2015]. Available from internet, <URL: <http://www.fujitsu.com/fts/products/computing/pc/tablets/stylistic-q704/>>.*

(Continued)

Primary Examiner — Cathron Brooks

Assistant Examiner — Teddy Falloway

(74) *Attorney, Agent, or Firm* — Staas & Halsey LLP

(57) **CLAIM**

The ornamental design for a personal computer, as shown and
described.

DESCRIPTION

FIG. 1 is a perspective view of front, top and right side of a
personal computer showing our new design;
FIG. 2 is a perspective view of rear, top and left side thereof;
FIG. 3 is a front view thereof;
FIG. 4 is a rear view thereof;
FIG. 5 is a left side view thereof;
FIG. 6 is a right side view thereof;
FIG. 7 is a top view thereof; and,
FIG. 8 is a bottom view thereof.

1 Claim, 6 Drawing Sheets

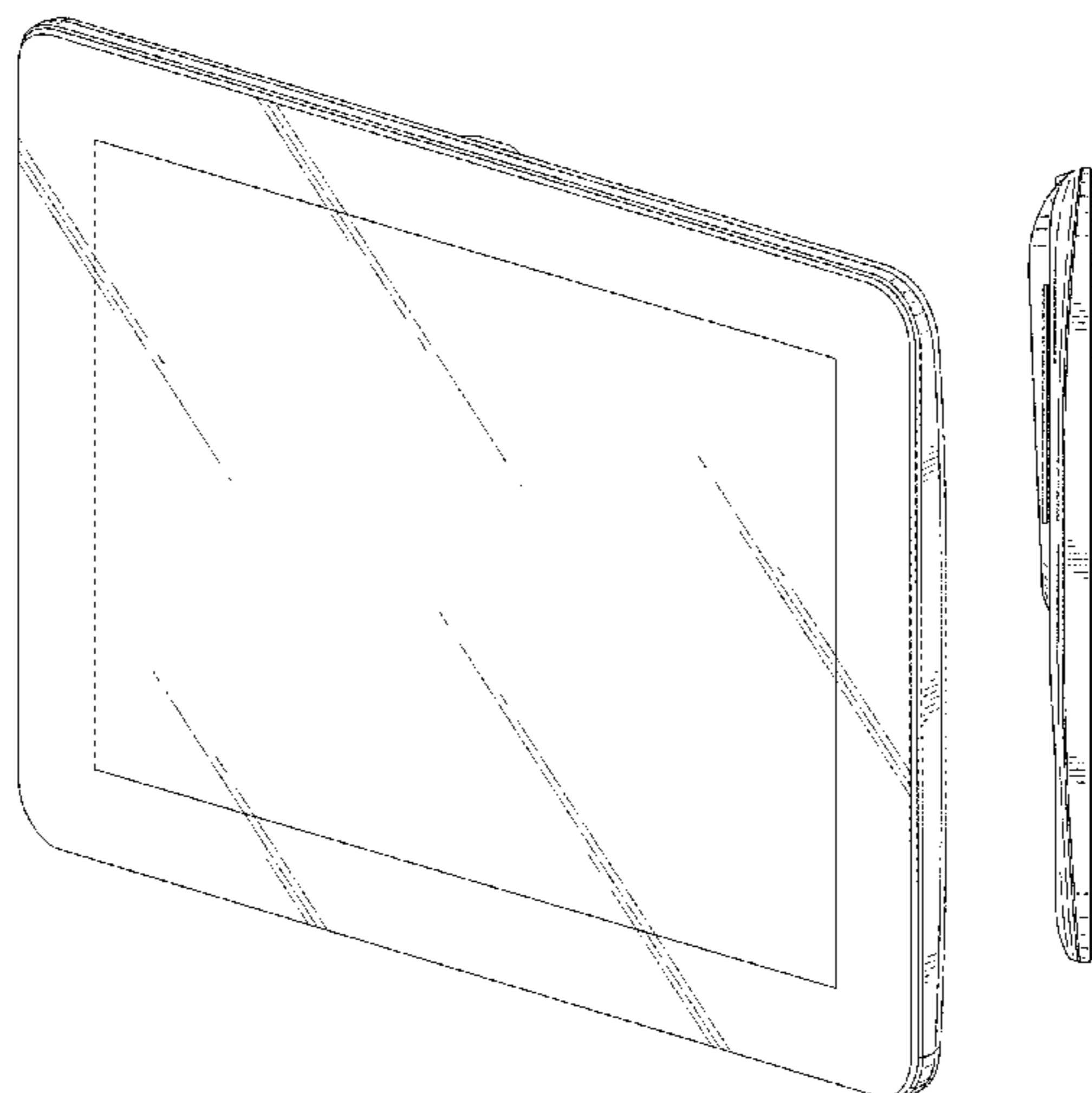

(56)

References Cited

OTHER PUBLICATIONS

U.S. PATENT DOCUMENTS

D692,880	S *	11/2013	Song et al.	D14/341
D694,211	S *	11/2013	Yuu et al.	D14/138 G
D694,212	S *	11/2013	Yuu et al.	D14/138 G
D695,249	S *	12/2013	Kim et al.	D14/138 G
D695,250	S *	12/2013	Kim et al.	D14/138 G
D695,255	S *	12/2013	Kim	D14/138 G
D696,249	S *	12/2013	Lee	D14/341
D696,250	S *	12/2013	Wang et al.	D14/341
D701,202	S *	3/2014	Choi	D14/341
D709,474	S *	7/2014	Kim et al.	D14/138 G
D711,360	S *	8/2014	Park	D14/248
D716,780	S *	11/2014	Park	D14/248
D716,799	S *	11/2014	Green et al.	D14/341
D720,345	S *	12/2014	Chu et al.	D14/341
D721,700	S *	1/2015	Satzger et al.	D14/341
D726,716	S *	4/2015	Green et al.	D14/341
2012/0314354	A1 *	12/2012	Rayner	361/679.01
2013/0016485	A1 *	1/2013	Allore et al.	361/752
2013/0057785	A1 *	3/2013	Hiratomo et al.	348/843
2013/0342977	A1 *	12/2013	Chang et al.	361/679.01
2014/0080542	A1 *	3/2014	Pan et al.	455/556.1

Fujitsu Stylistic Q704 (YouTube), available Feb. 16, 2014, [online], [site visited May 19, 2015]. Video available from internet, <URL: <https://www.youtube.com/watch?v=G9Wmg6vZXEc>.*

AMD Tablet (via Mobile Phone Advisor), available Nov. 16, 2013, [online], [site visited May 19, 2015]. Available from internet, <URL: <http://mobilephoneadvise.com/exclusive-amd-entering-the-tablet-business-new-images-reveal-all-new-device>.*

ASUS Transformer Pad, available Oct. 29, 2013, [online], [site visited May 19, 2015]. Available from internet, <URL: <http://raqwe.blogspot.com/2013/10/review-of-tablet-asus-transformer-pad.html>.*

Fujitsu Stylistic Q584, available Oct. 23, 2014, [online], [site visited May 19, 2015]. Available from internet, <URL: <http://www.ferra.ru/ru/notebooks/review/fujitsu-stylistic-q584-tablet-lte-wqnga/#VVqq0mdFBaT>.*

Xolo Play Tegra Note, available Dec. 14, 2013, [online], [site visited May 19, 2015]. Available from internet, <URL: <http://tech.firstpost.com/news-analysis/first-look-xolos-nvidia-powered-play-tegra-note-tablet-105834.html>.*

* cited by examiner

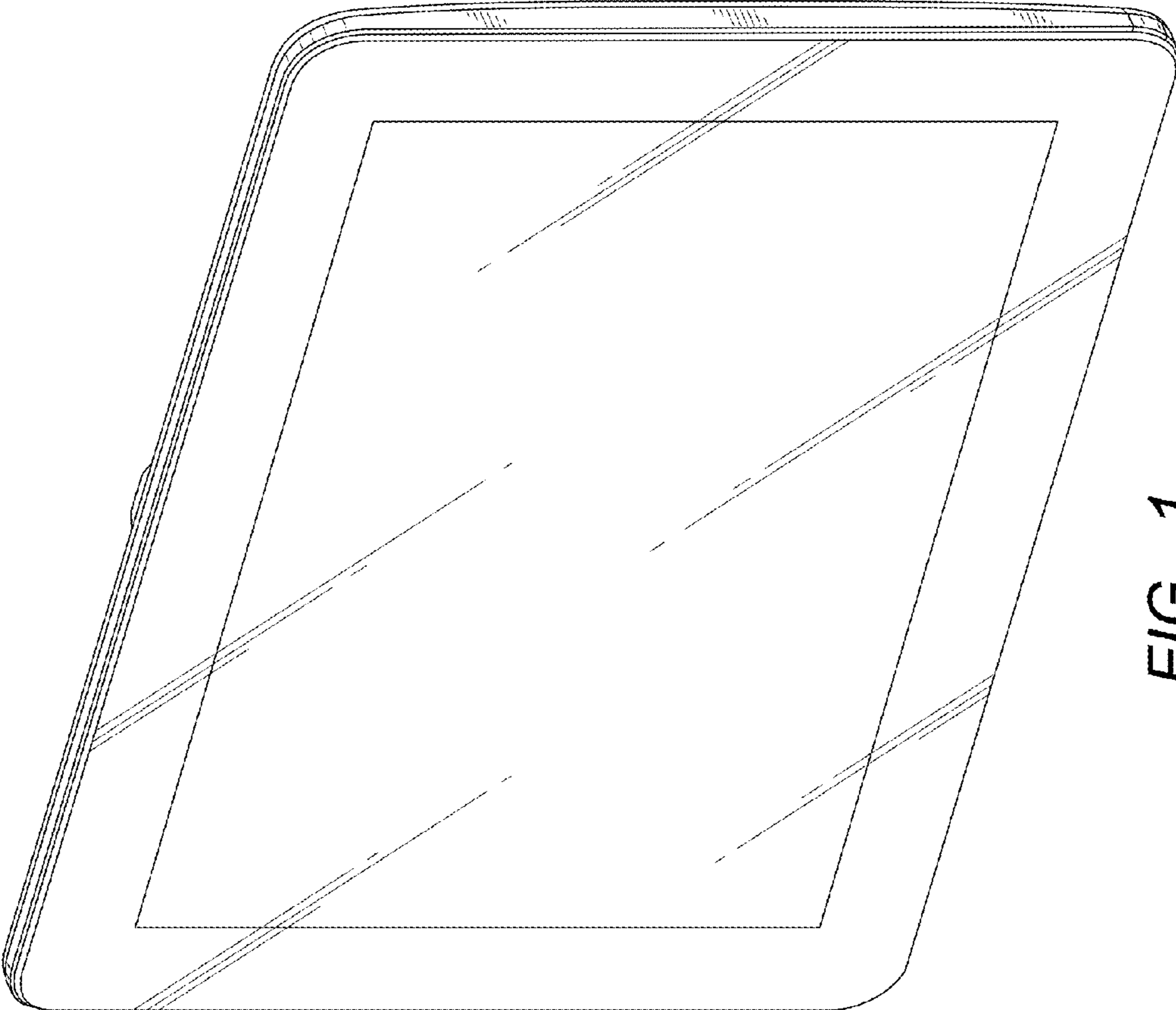

FIG. 1

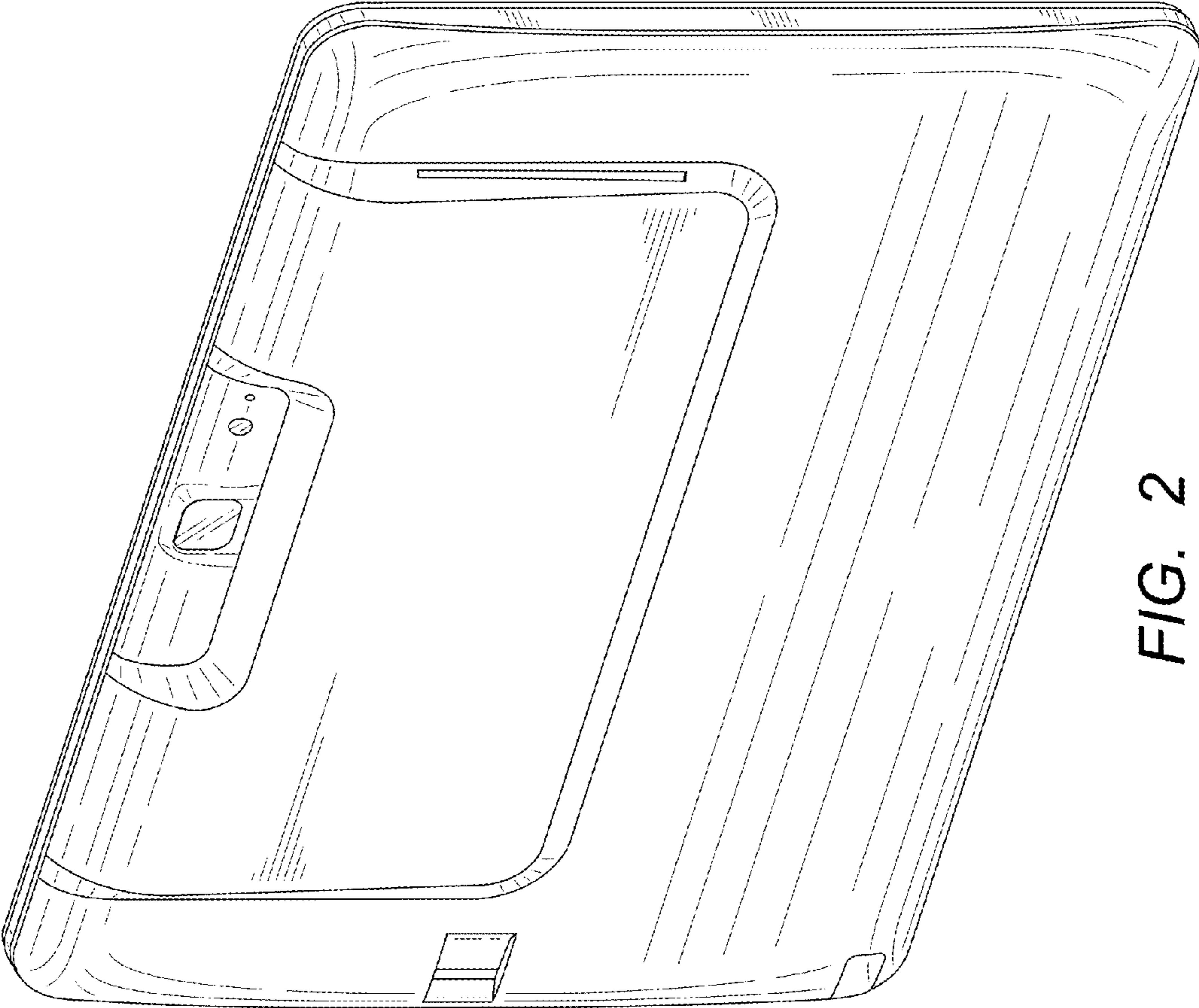

FIG. 2

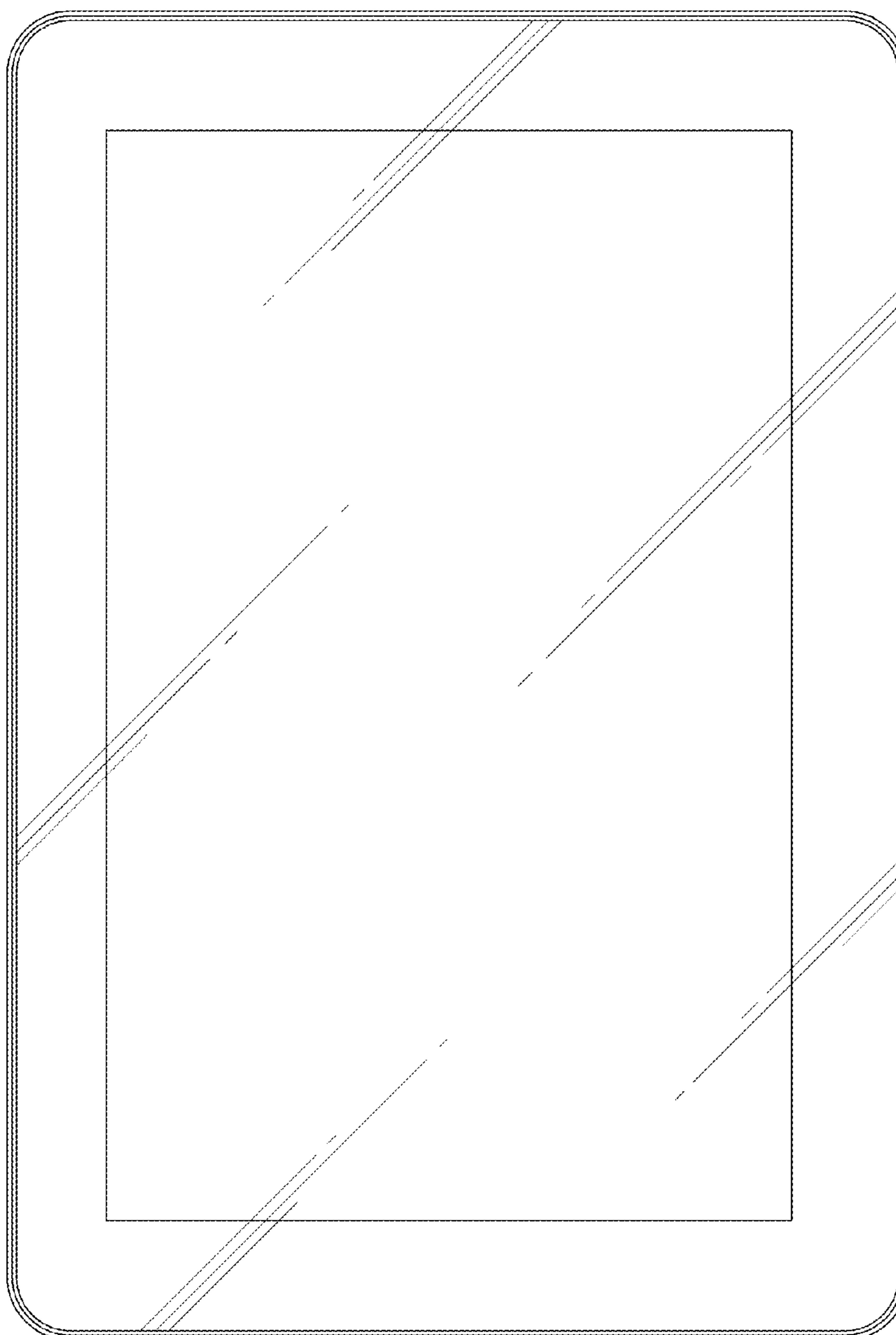

FIG. 3

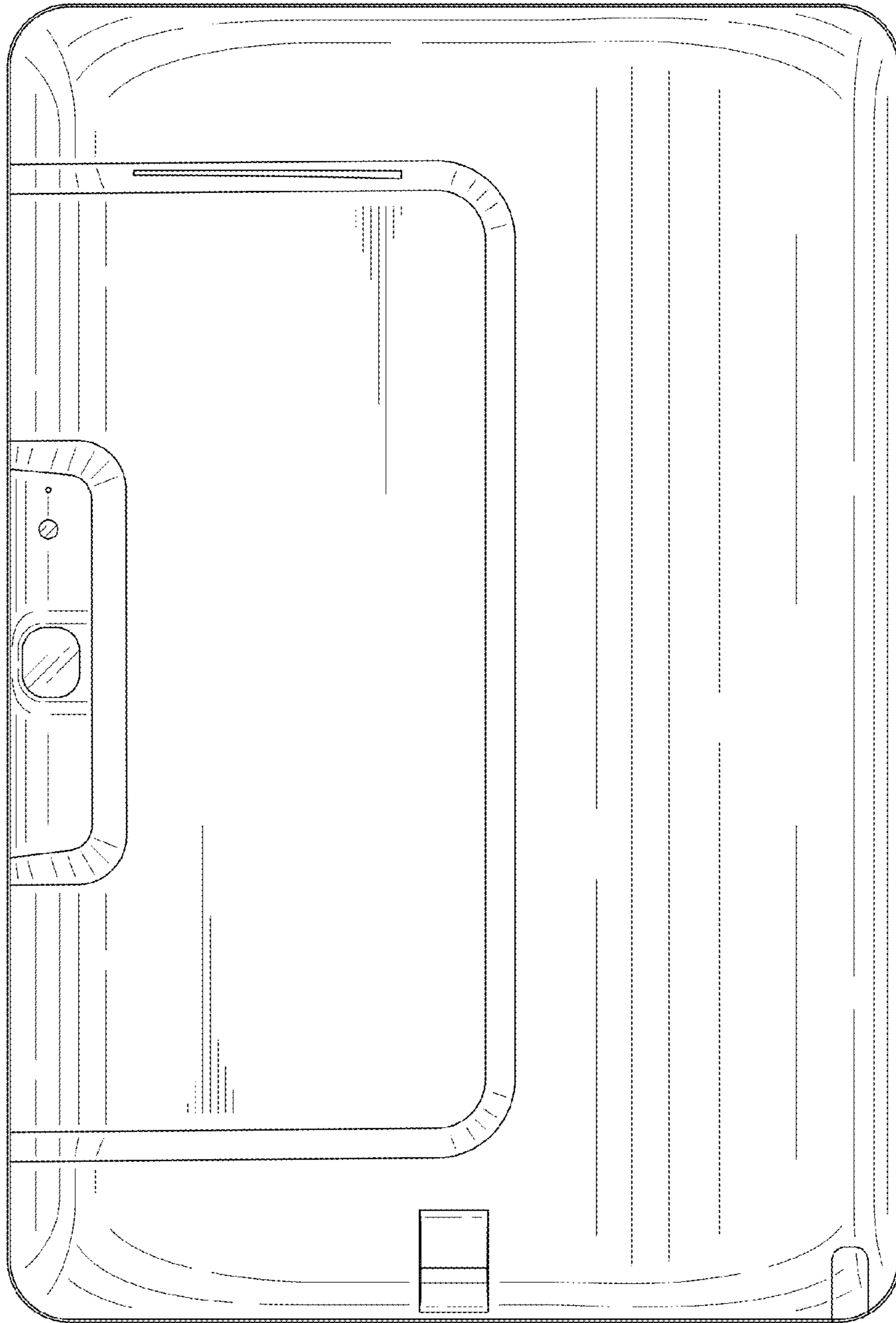

FIG. 4

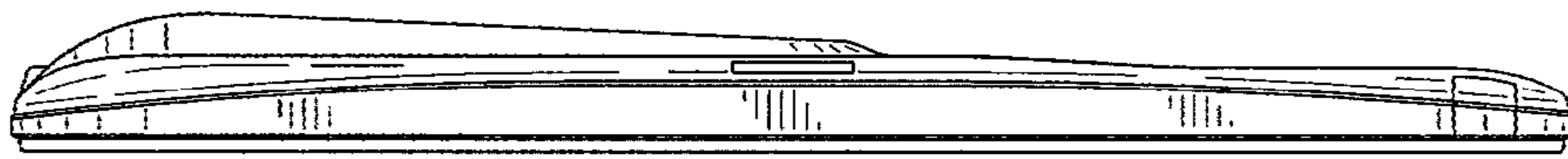

FIG. 6

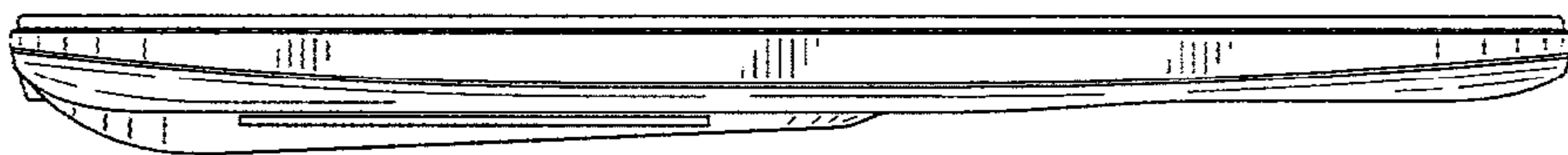

FIG. 5

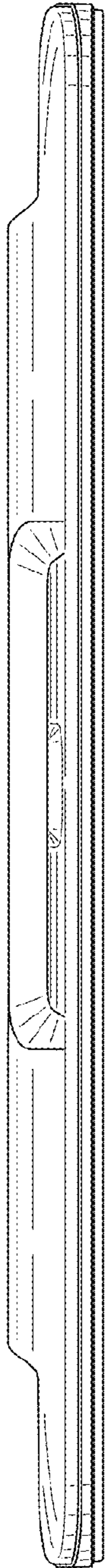

FIG. 7

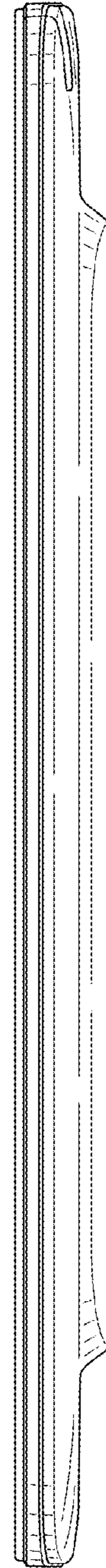

FIG. 8