



US00D748089S

(12) **United States Design Patent**
Shi

(10) **Patent No.:** **US D748,089 S**
(45) **Date of Patent:** **** Jan. 26, 2016**

(54) **ELECTRONIC DEVICE**
(71) Applicant: **LENOVO (BEIJING) CO., LTD.**,
Beijing (CN)
(72) Inventor: **Wenbo Shi**, Beijing (CN)
(73) Assignee: **Lenovo (Beijing) Co., Ltd.**, Beijing
(CN)
(**) Term: **14 Years**
(21) Appl. No.: **29/483,811**
(22) Filed: **Mar. 3, 2014**
(30) **Foreign Application Priority Data**
Sep. 2, 2013 (CN) 2013 3 0424816
(51) **LOC (10) Cl.** **14-02**
(52) **U.S. Cl.**
USPC **D14/315**
(58) **Field of Classification Search**
USPC D14/315-327; D18/1, 2, 7, 11;
235/145 A, 145 R; 341/22, 23; 345/104,
345/156, 168, 169, 173; 361/679.08,
361/679.09, 679.11, 679.26, 679.27
CPC G06F 1/16; G06F 1/1616; G06F 1/1681;
G06F 1/1683; H01R 35/02; H03M 11/00;
G09B 13/04; H03K 17/94
See application file for complete search history.

(56) **References Cited**
U.S. PATENT DOCUMENTS
6,775,129 B1 * 8/2004 Ghosh et al. 361/679.27
D631,472 S * 1/2011 Kawase et al. D14/327
D631,879 S * 2/2011 Kawase D14/327
D651,206 S * 12/2011 Kim et al. D14/315
D675,611 S * 2/2013 Wen et al. D14/315

* cited by examiner

Primary Examiner — Freda S Nunn
(74) *Attorney, Agent, or Firm* — Oppedahl Patent Law Firm
LLC

(57) **CLAIM**
The ornamental design for an electronic device, as shown and
described.

DESCRIPTION

FIG. 1 is a top plan view of an electronic device showing our
new design;

FIG. 2 is a bottom plan view thereof;
FIG. 3 is a left side elevational view thereof;
FIG. 4 is a right side elevational view thereof;
FIG. 5 is a front elevational view thereof;
FIG. 6 is a back elevational view thereof;
FIG. 7 is a front elevational view thereof with the lid being in
a first open position, it being understood that all other surfaces
are the same;
FIG. 8 is a left side elevational view thereof;
FIG. 9 is a right side elevational view thereof;
FIG. 10 is a top plan view thereof;
FIG. 11 is a bottom plan view thereof;
FIG. 12 is a top perspective view thereof;
FIG. 13 is a top plan view thereof with the lid being in a
second open position, it being understood that all other sur-
faces are the same;
FIG. 14 is a left side elevational view thereof;
FIG. 15 is a right side elevational view thereof;
FIG. 16 is a front elevational view thereof;
FIG. 17 is a back elevational view thereof;
FIG. 18 is a right side perspective view thereof;
FIG. 19 is a back elevational view with the lid being in a
third open position, it being understood that all other surfaces
are the same;
FIG. 20 is a left side elevational view thereof;
FIG. 21 is a right side elevational view thereof;
FIG. 22 is a top plan view thereof;
FIG. 23 is a bottom plan view thereof;
FIG. 24 is a top side perspective view thereof wherein the
keyboard surface is face down on a supporting surface;
FIG. 25 is a top side back perspective view thereof wherein
the front edges are touching a supporting surface;
FIG. 26 is a top front side perspective view thereof;
FIG. 27 is a top plan view thereof with the lid being in a fourth
position, it being understood that all other surfaces are the
same;
FIG. 28 is a bottom plan view thereof;
FIG. 29 is a left side elevational view thereof;
FIG. 30 is a right side elevational view thereof;
FIG. 31 is a back elevational view thereof; and,
FIG. 32 is a back side perspective view thereof.
The features shown in broken lines in the drawings depict
environmental subject matter and form no part of the claimed
design.

1 Claim, 19 Drawing Sheets

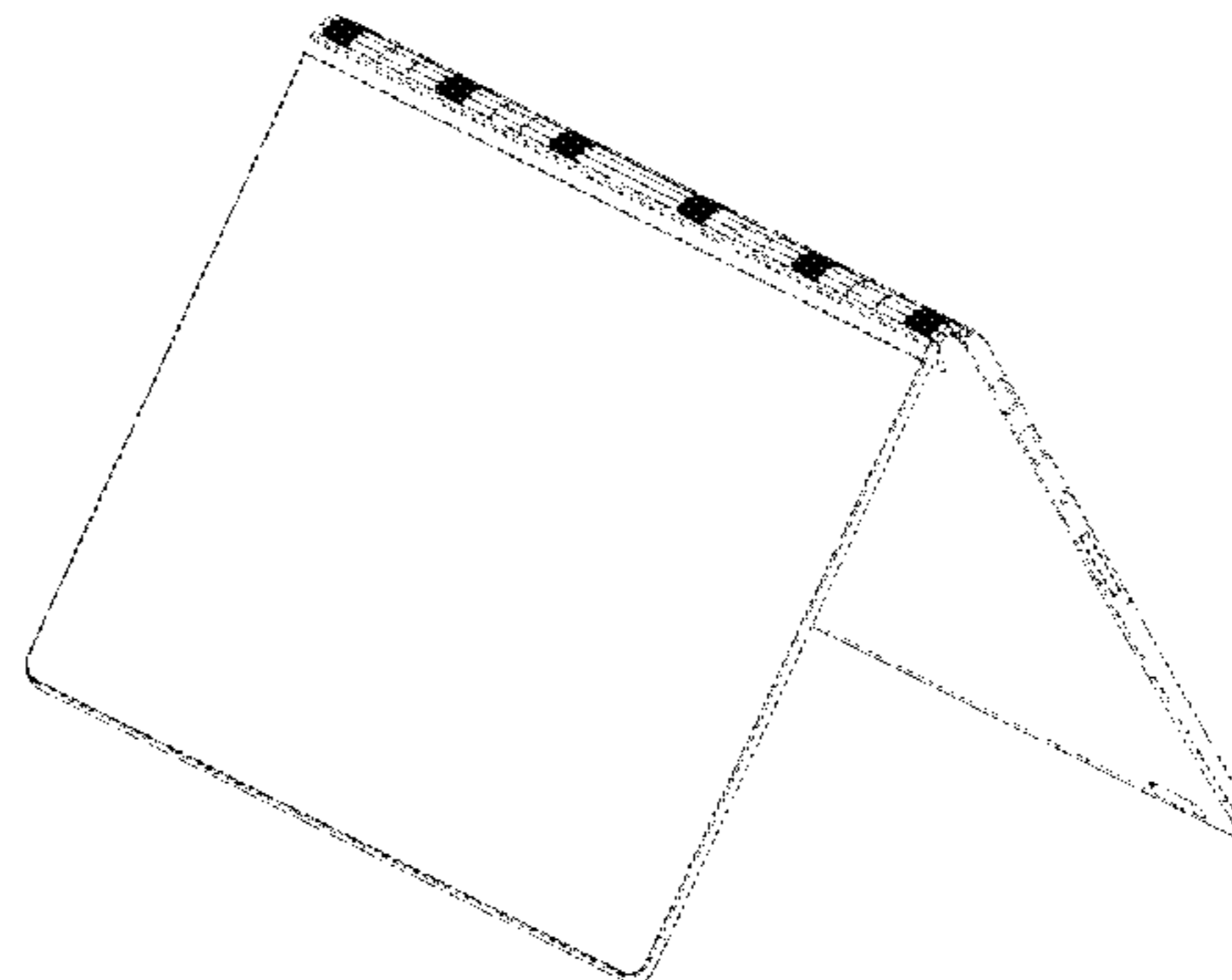
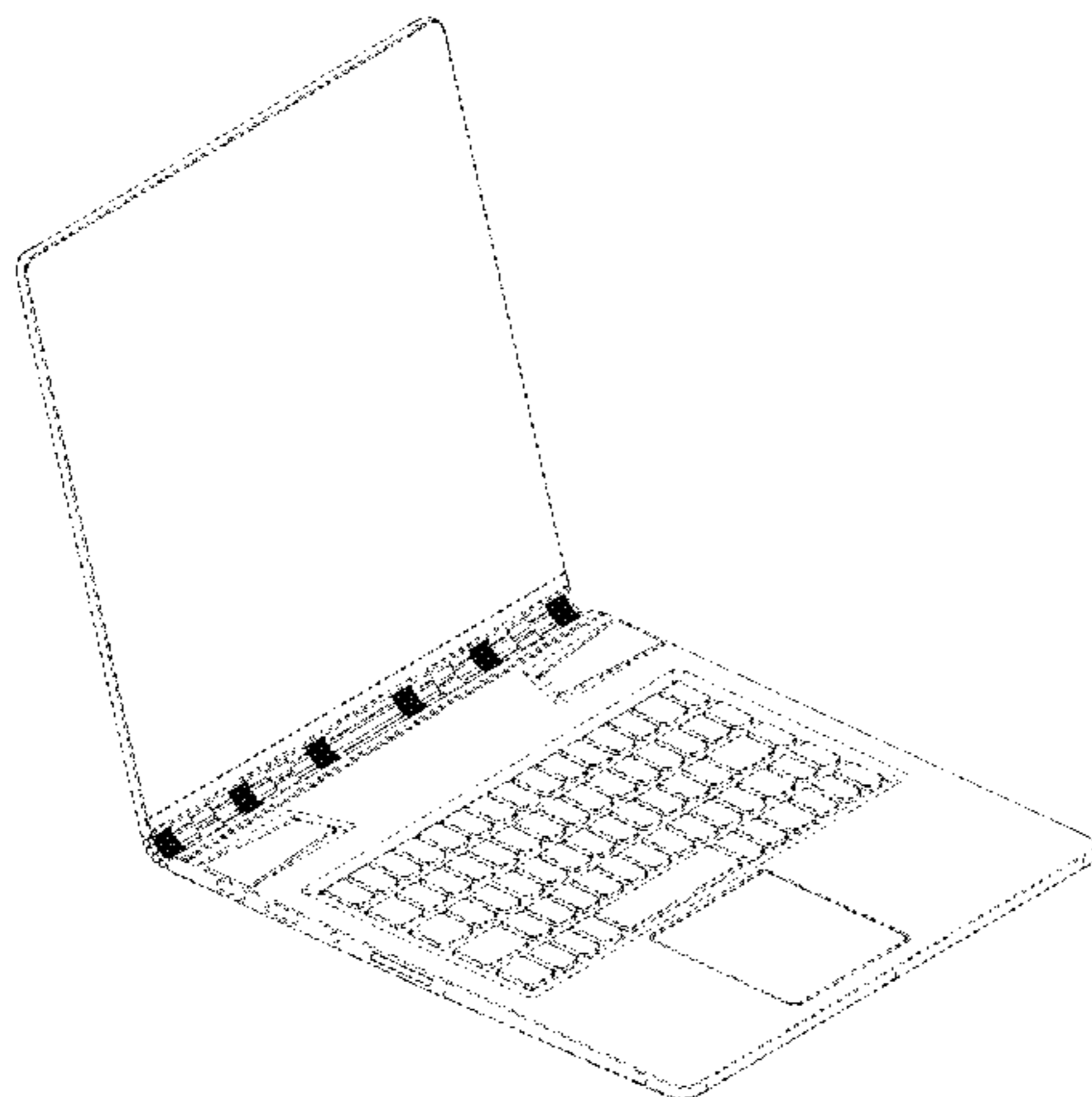

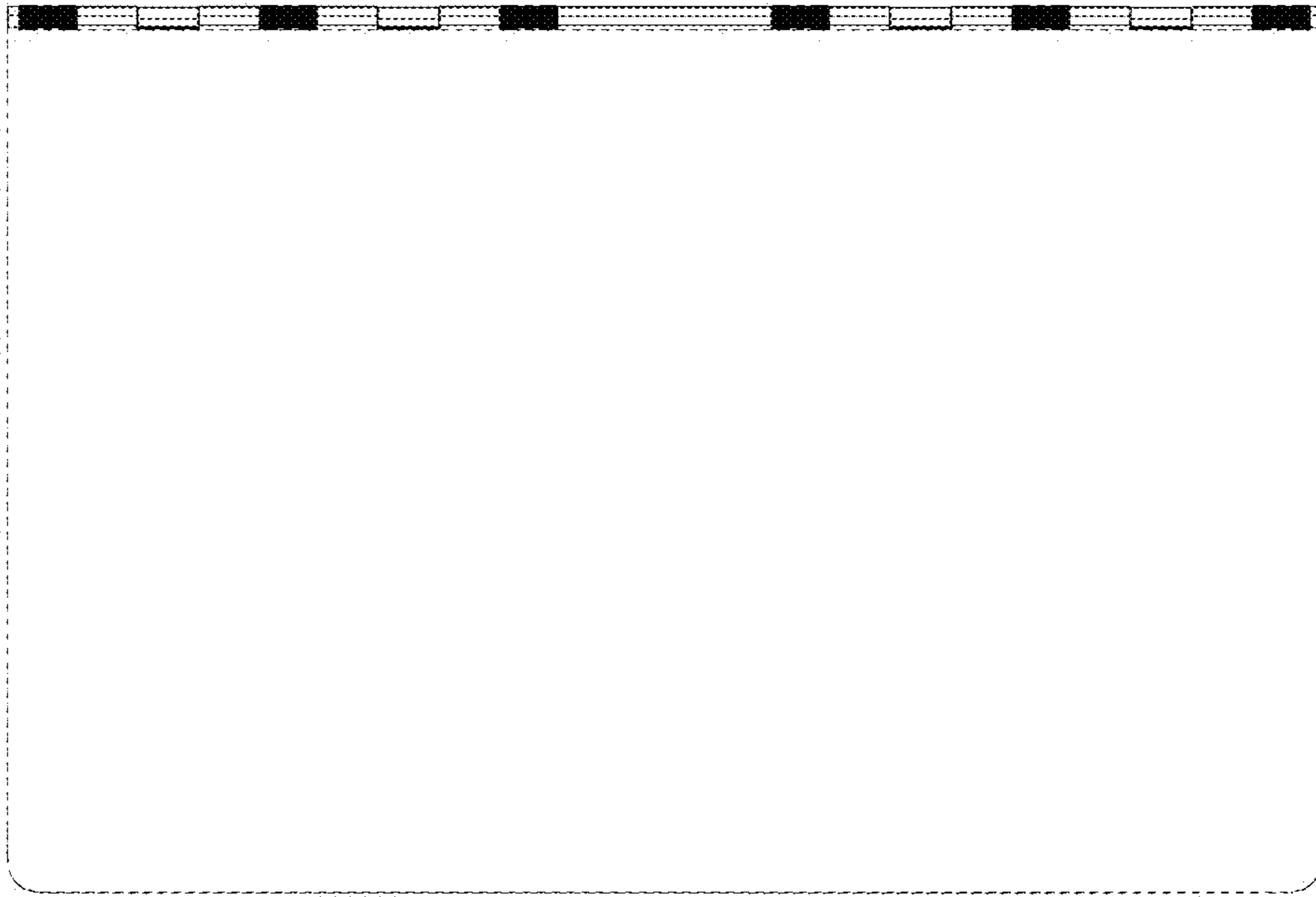

Fig.1

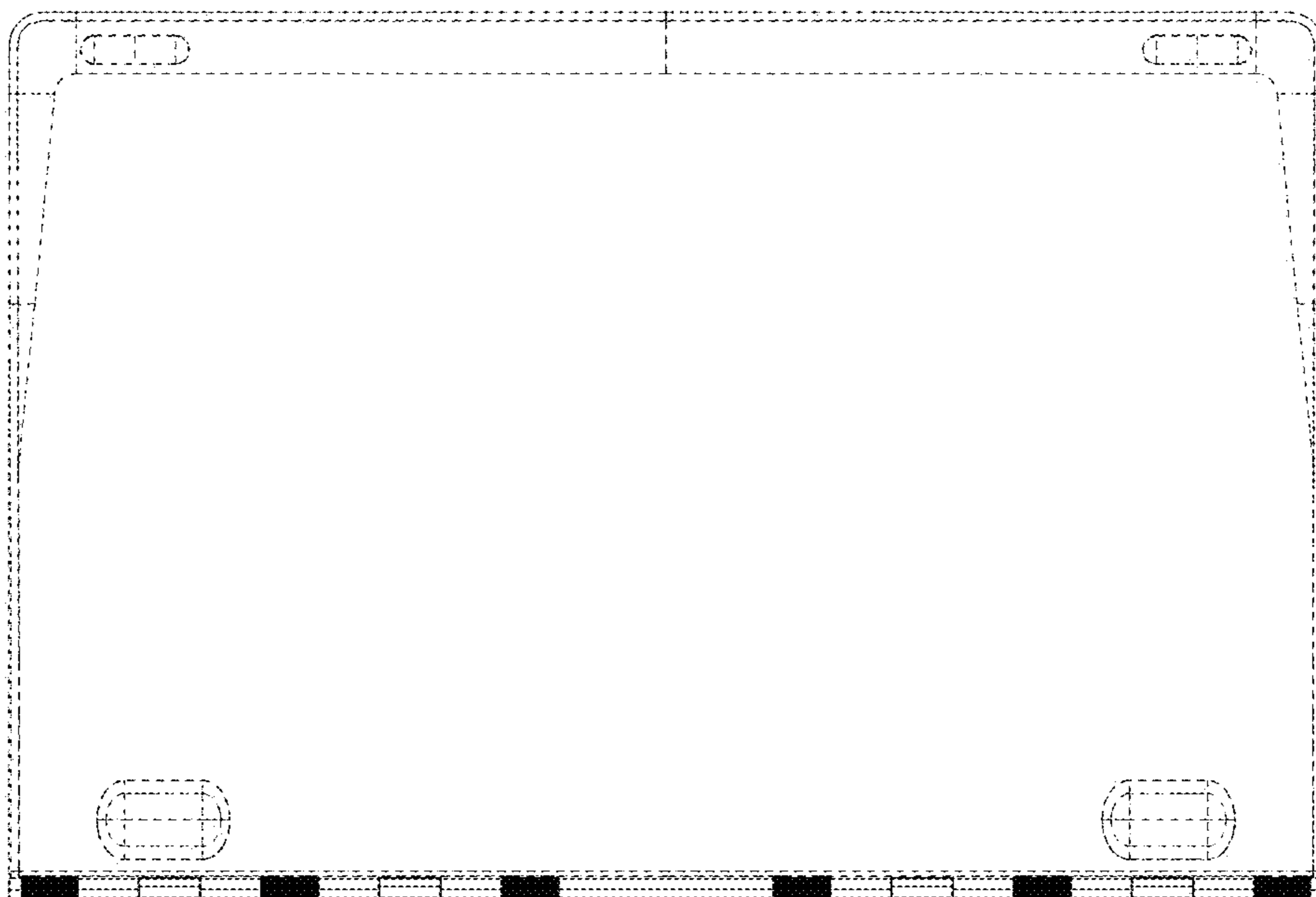

Fig.2

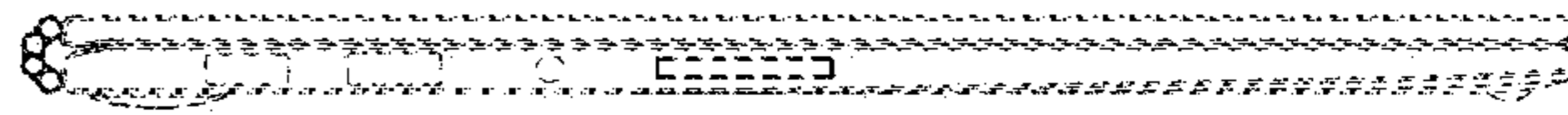

Fig.3

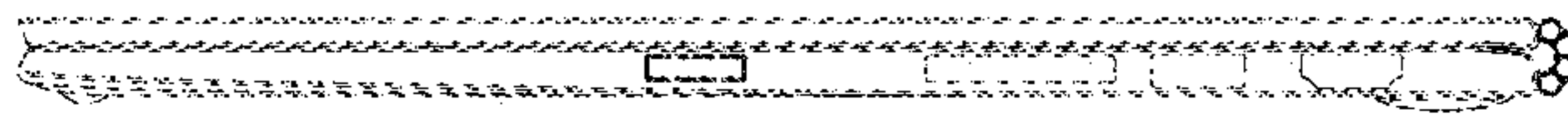

Fig.4

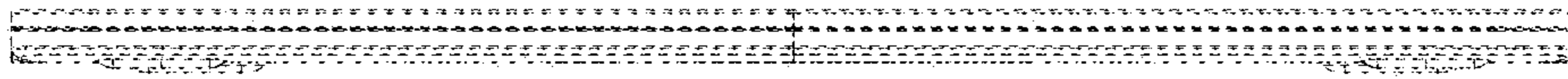

Fig.5

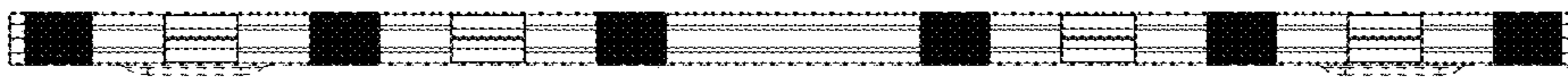

Fig.6

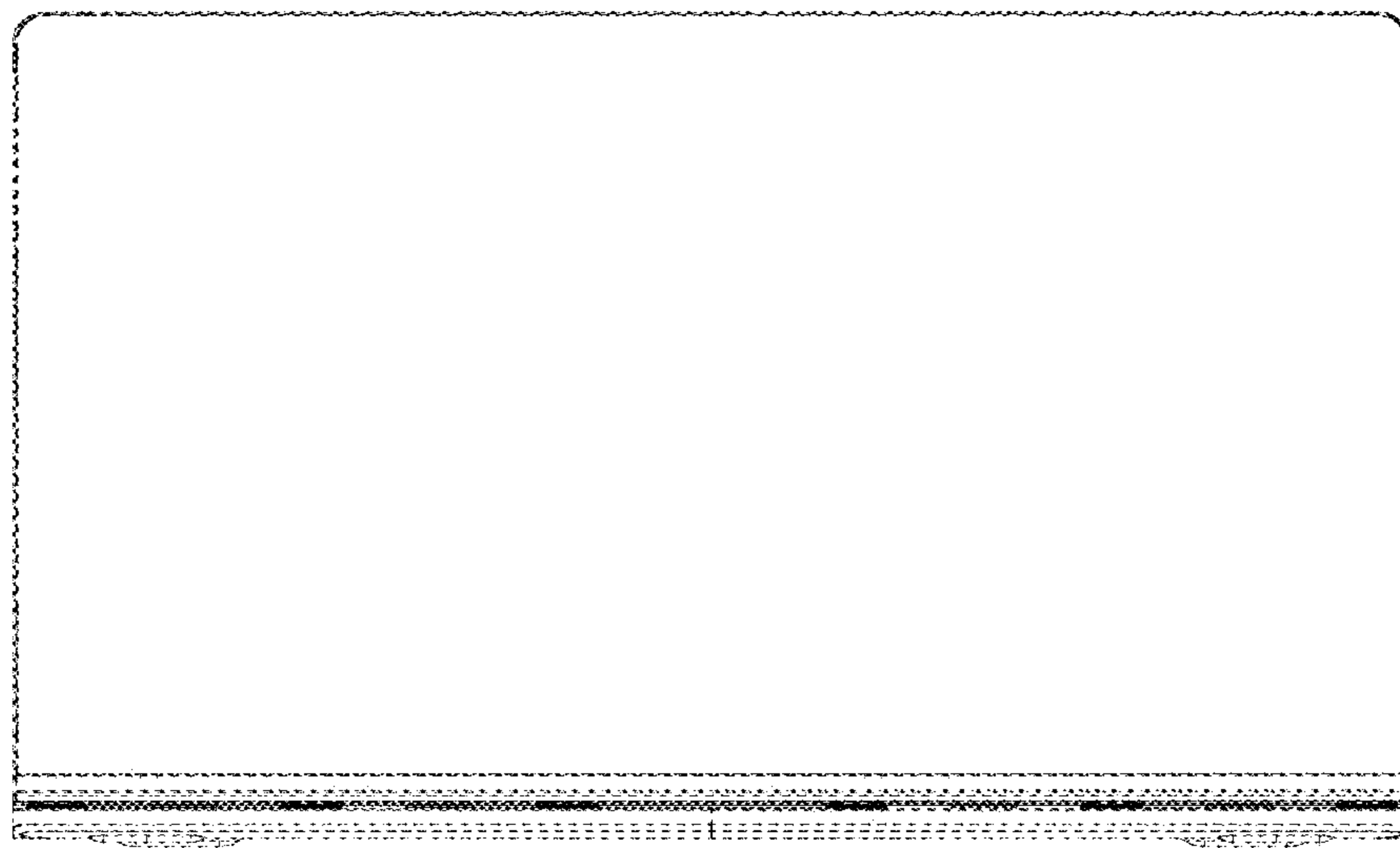

Fig.7

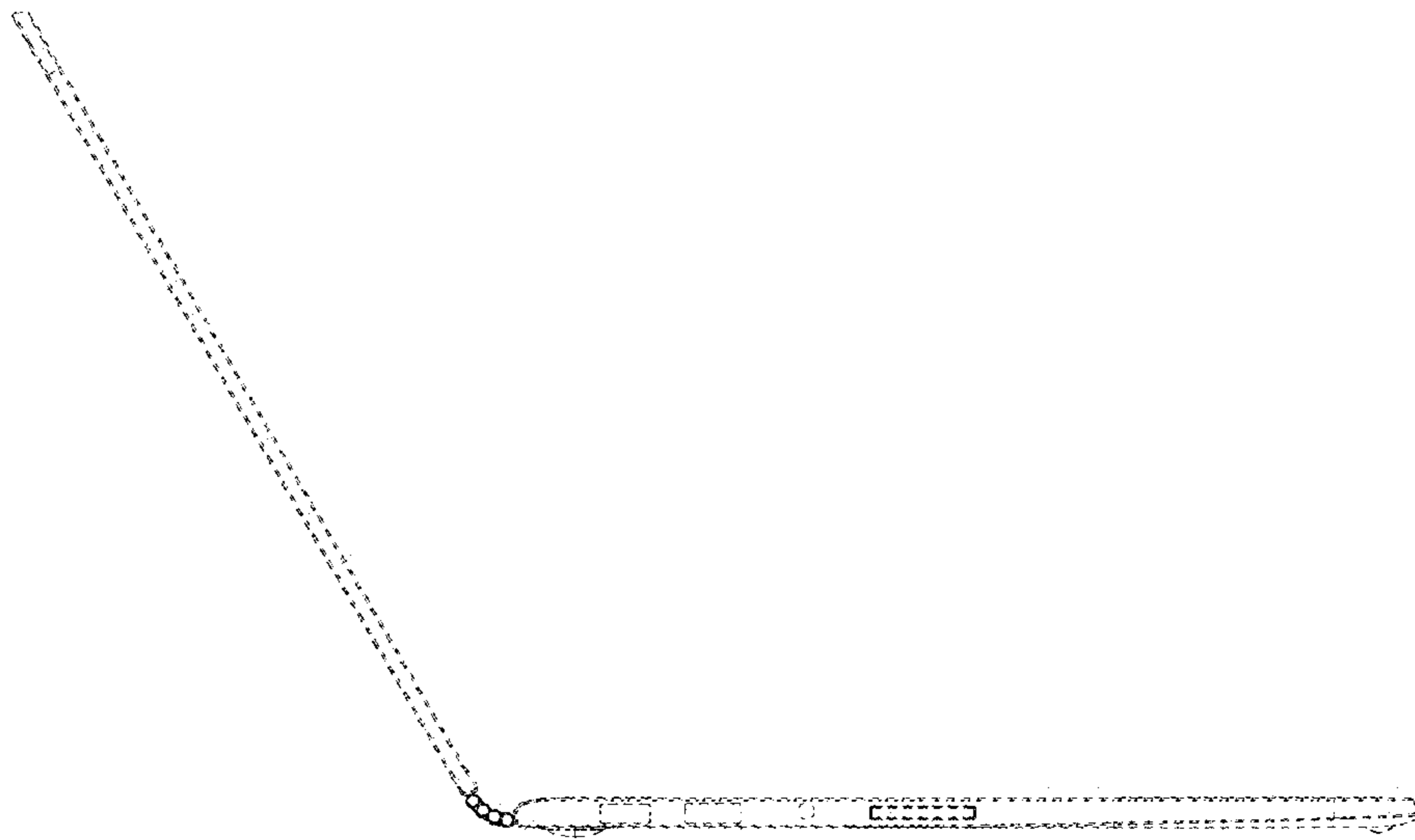

Fig.8

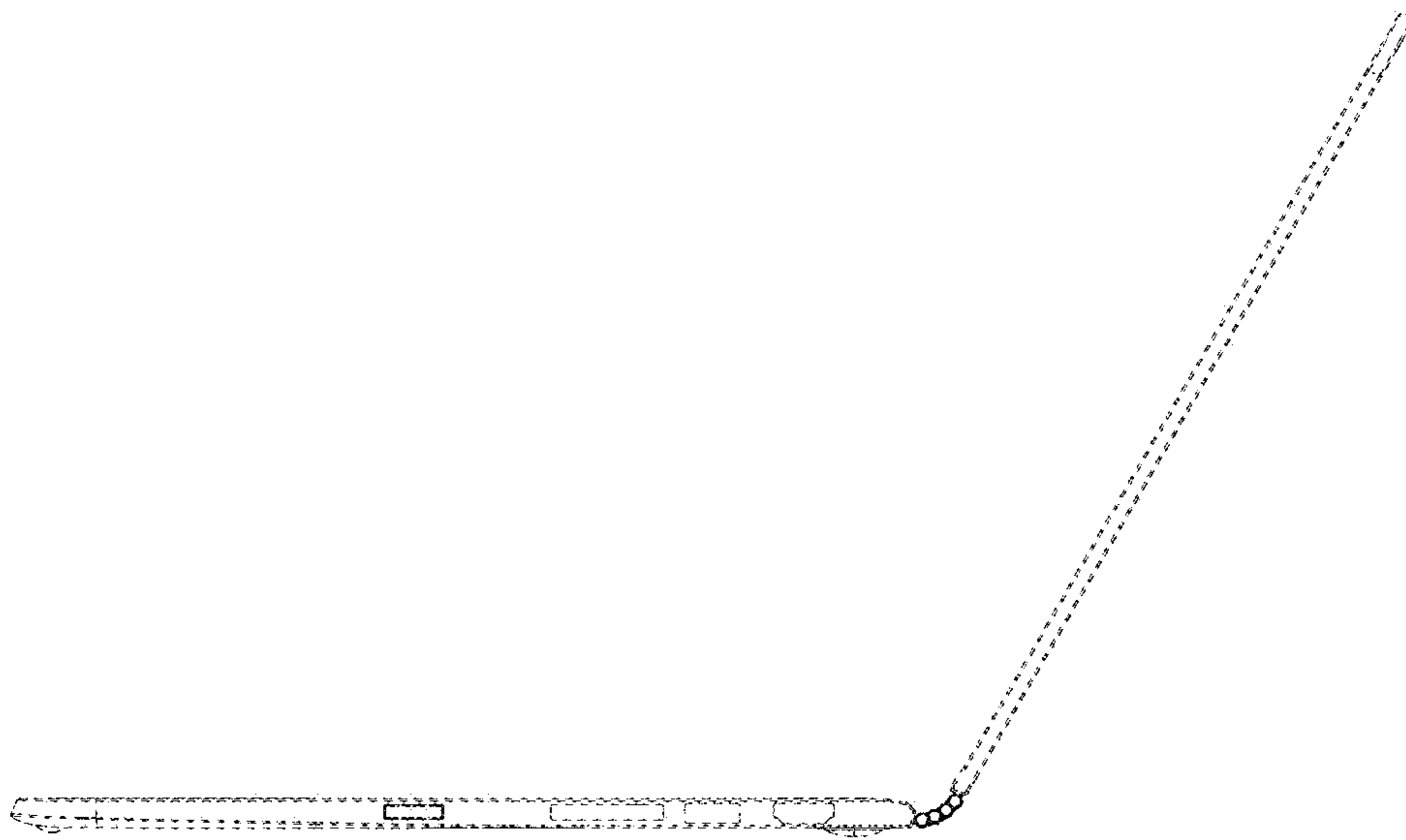

Fig.9

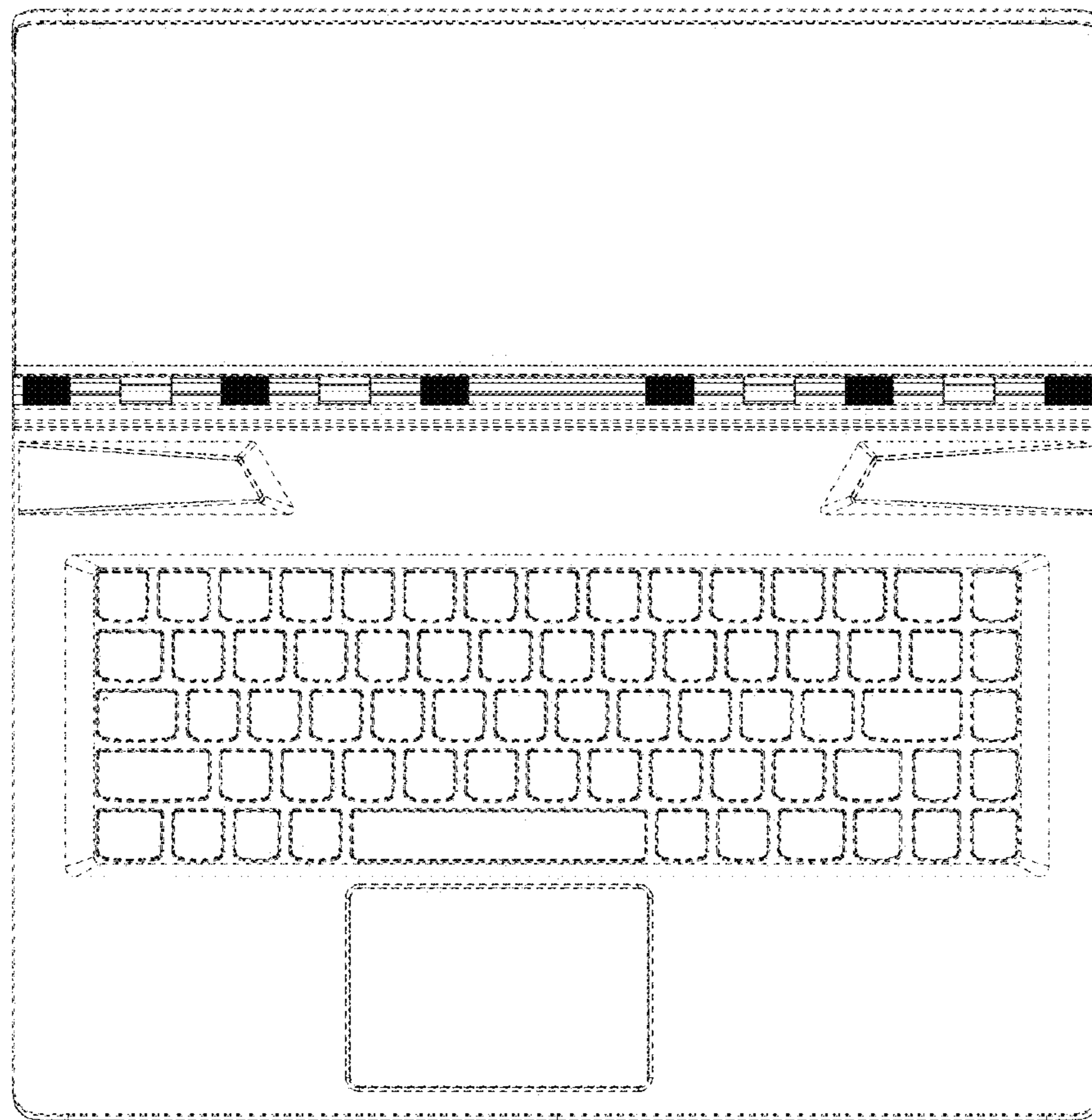

Fig.10

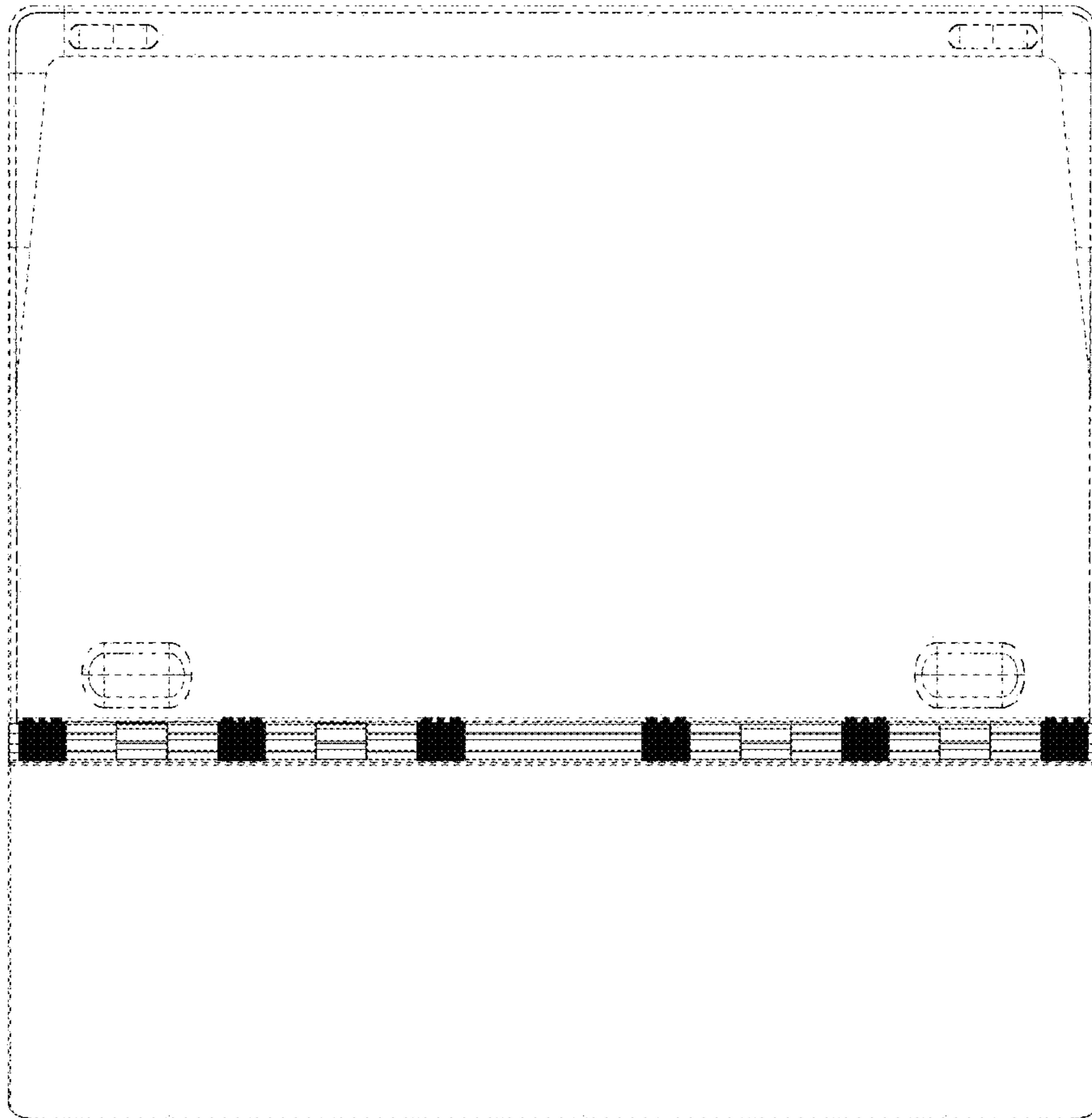

Fig.11

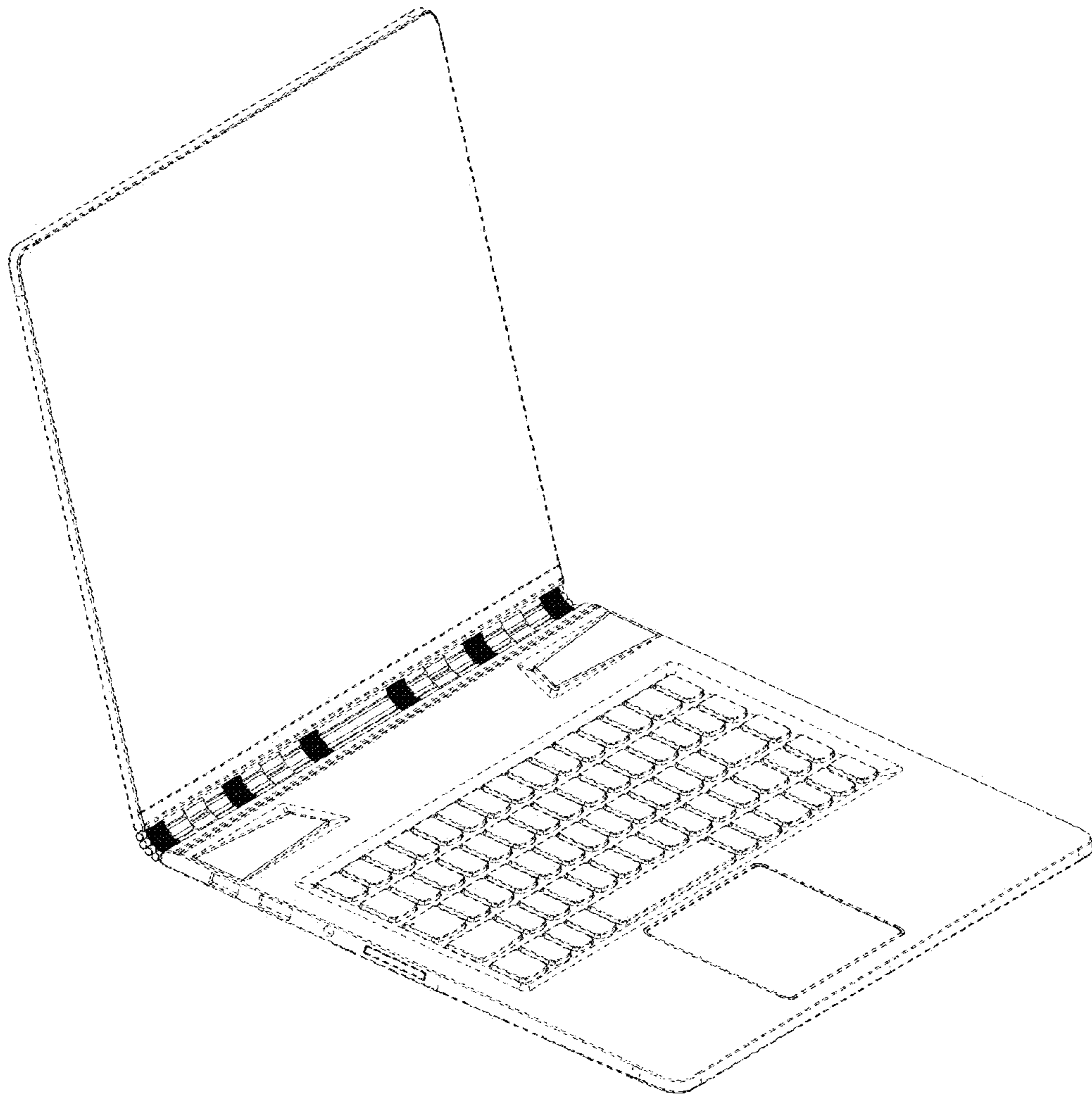

Fig.12

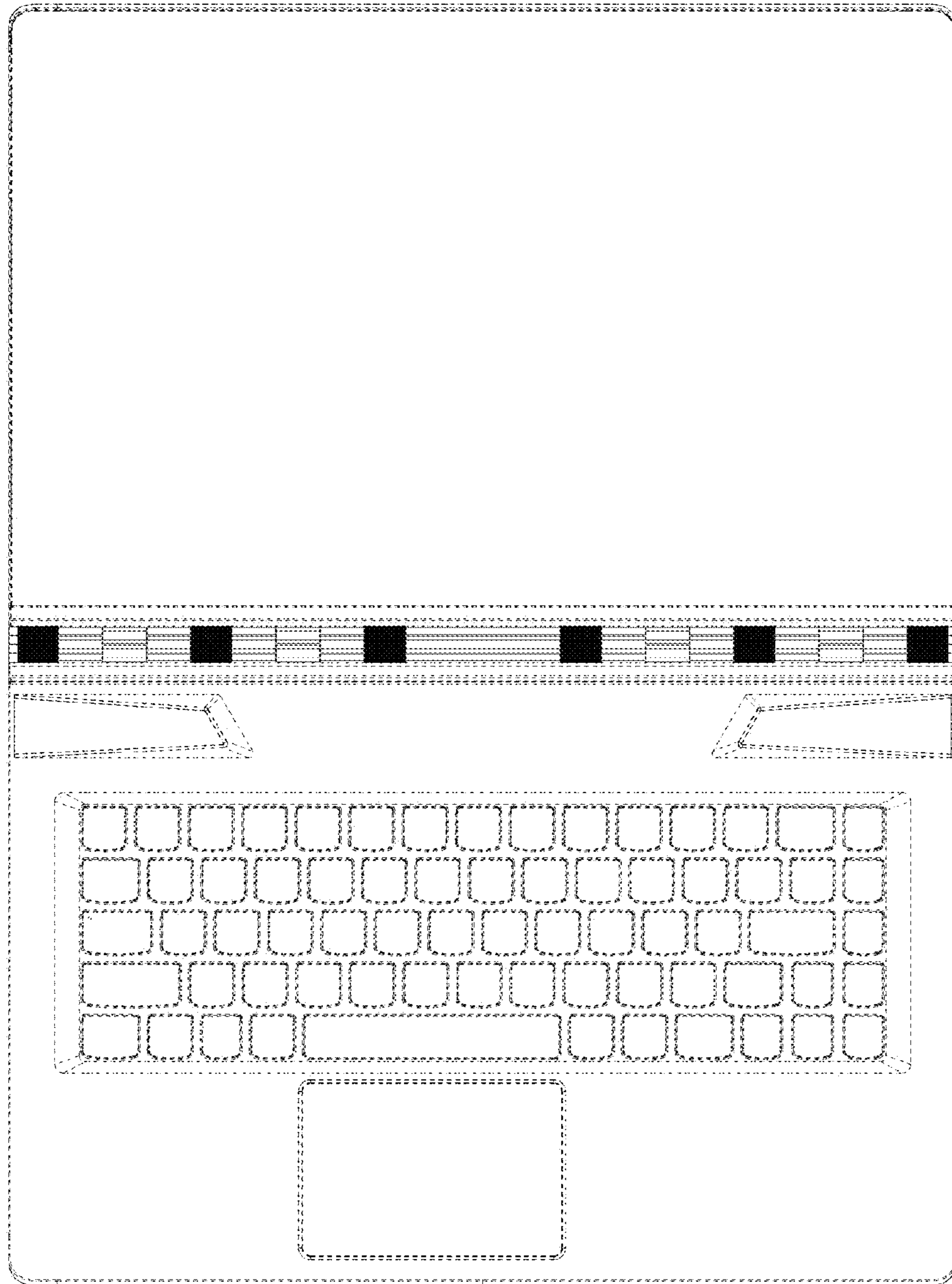

Fig.13



Fig. 14



Fig. 15

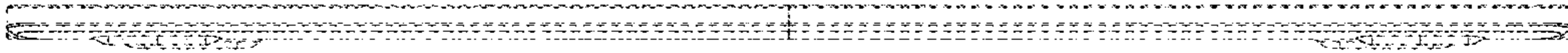

Fig.16

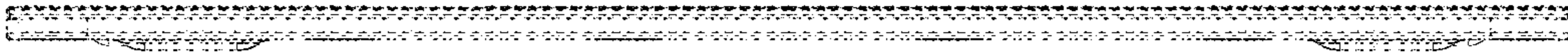

Fig.17

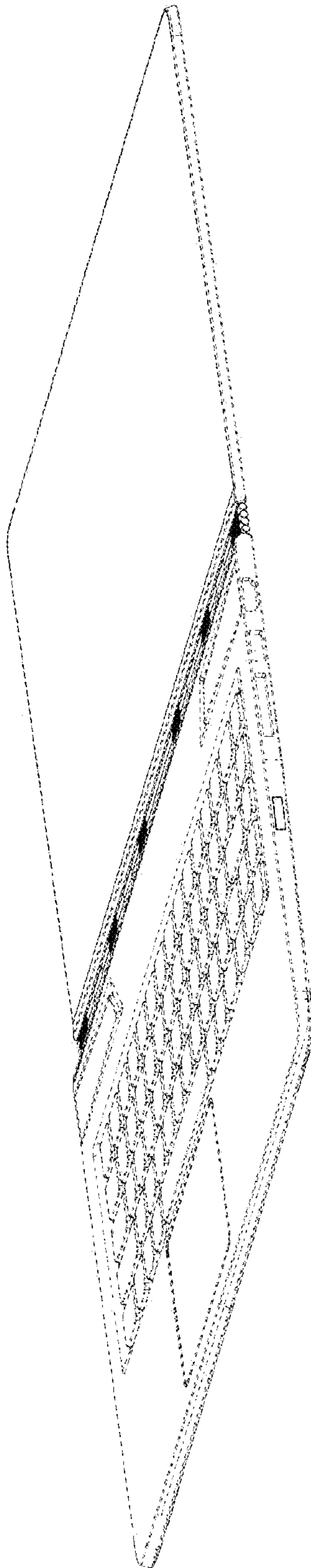

Fig.18

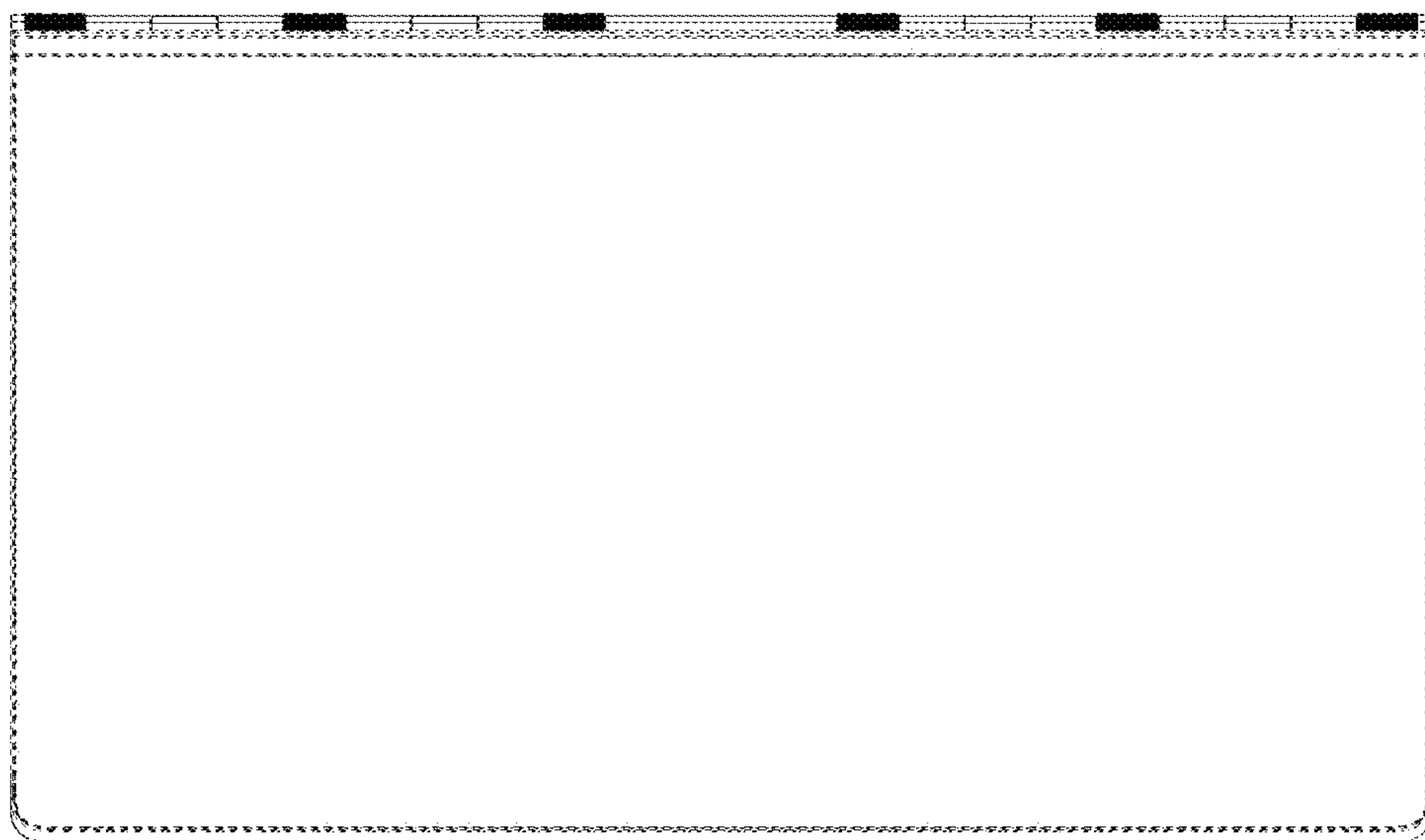

Fig.19

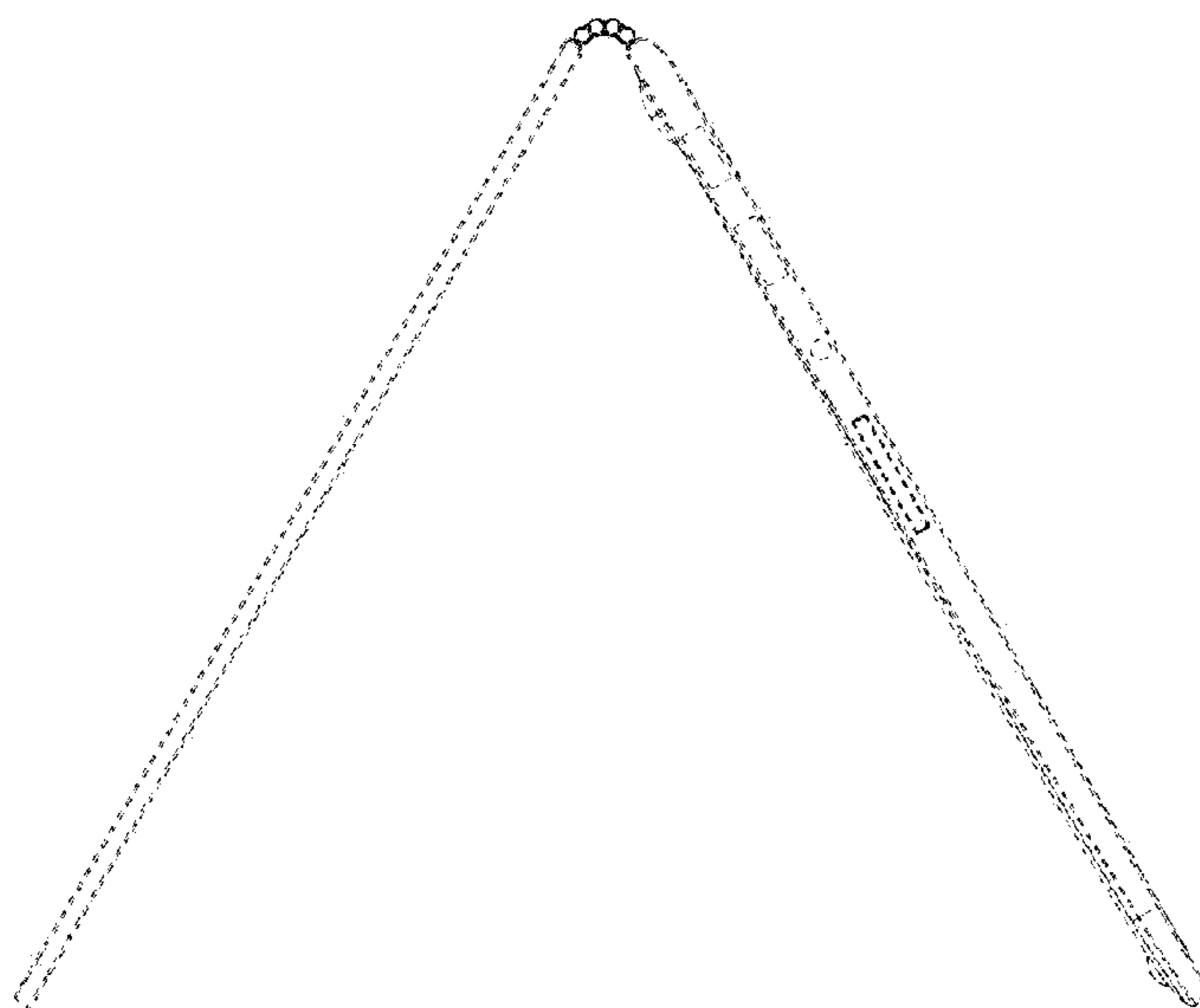

Fig.20

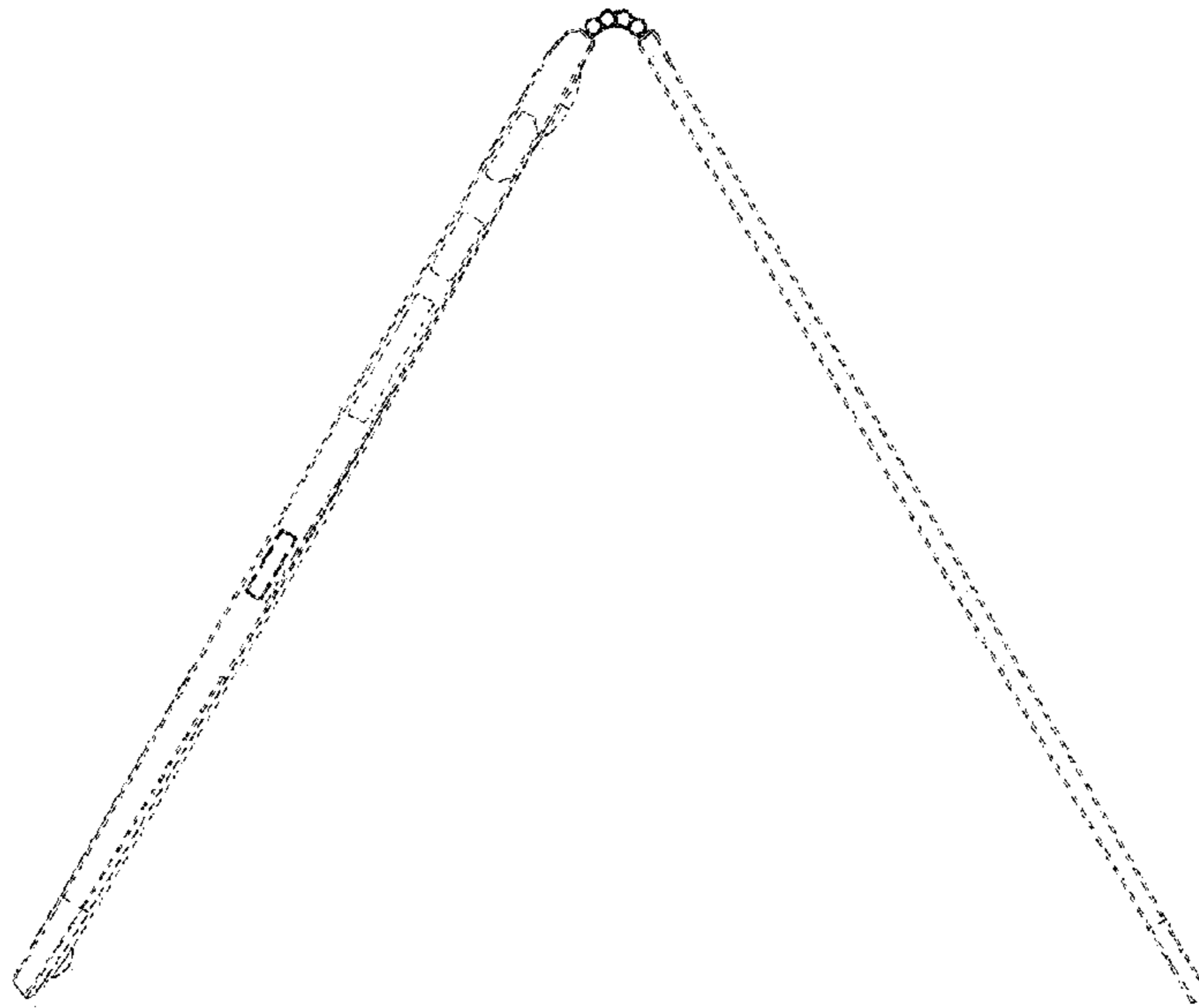

Fig.21

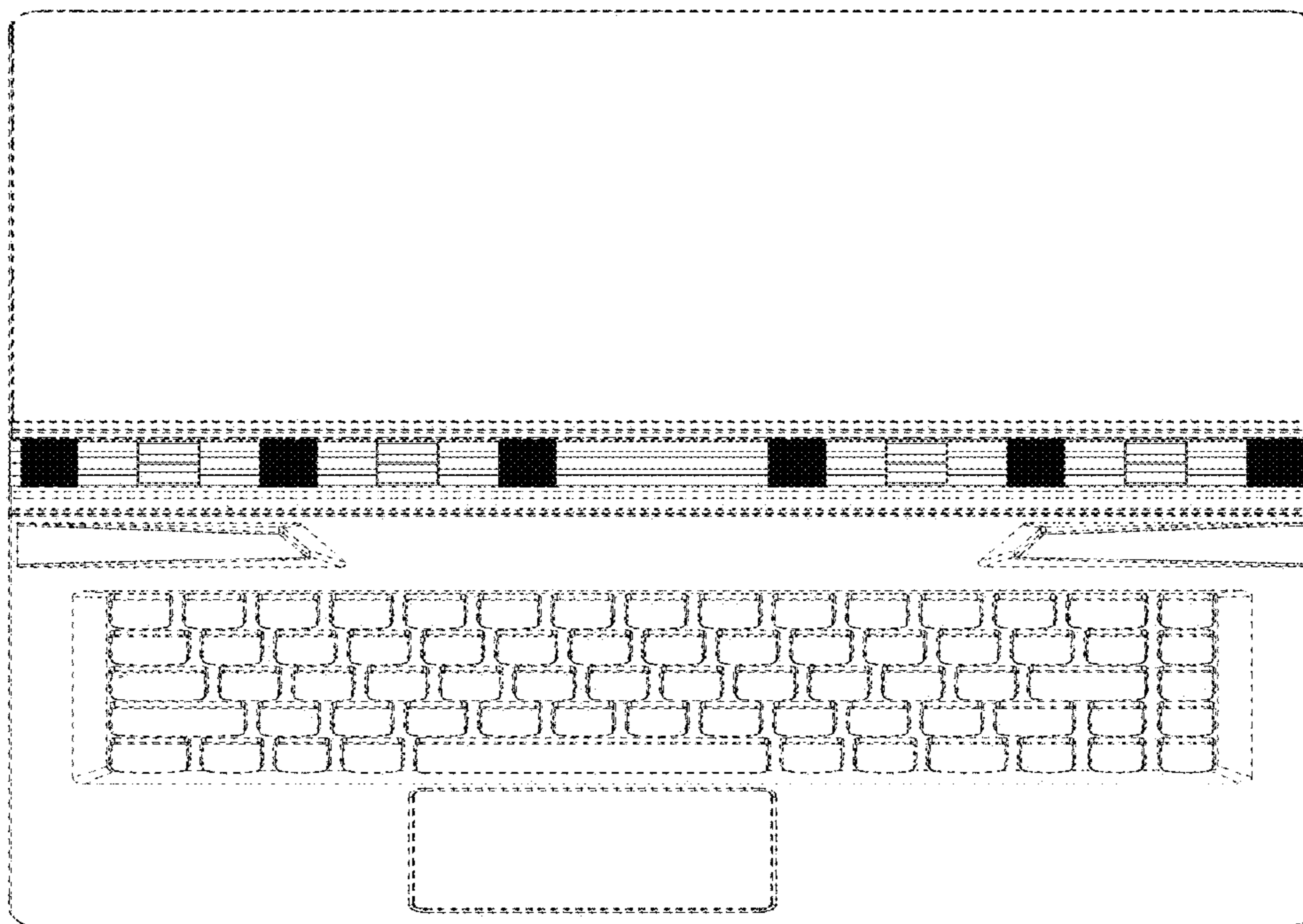

Fig.22

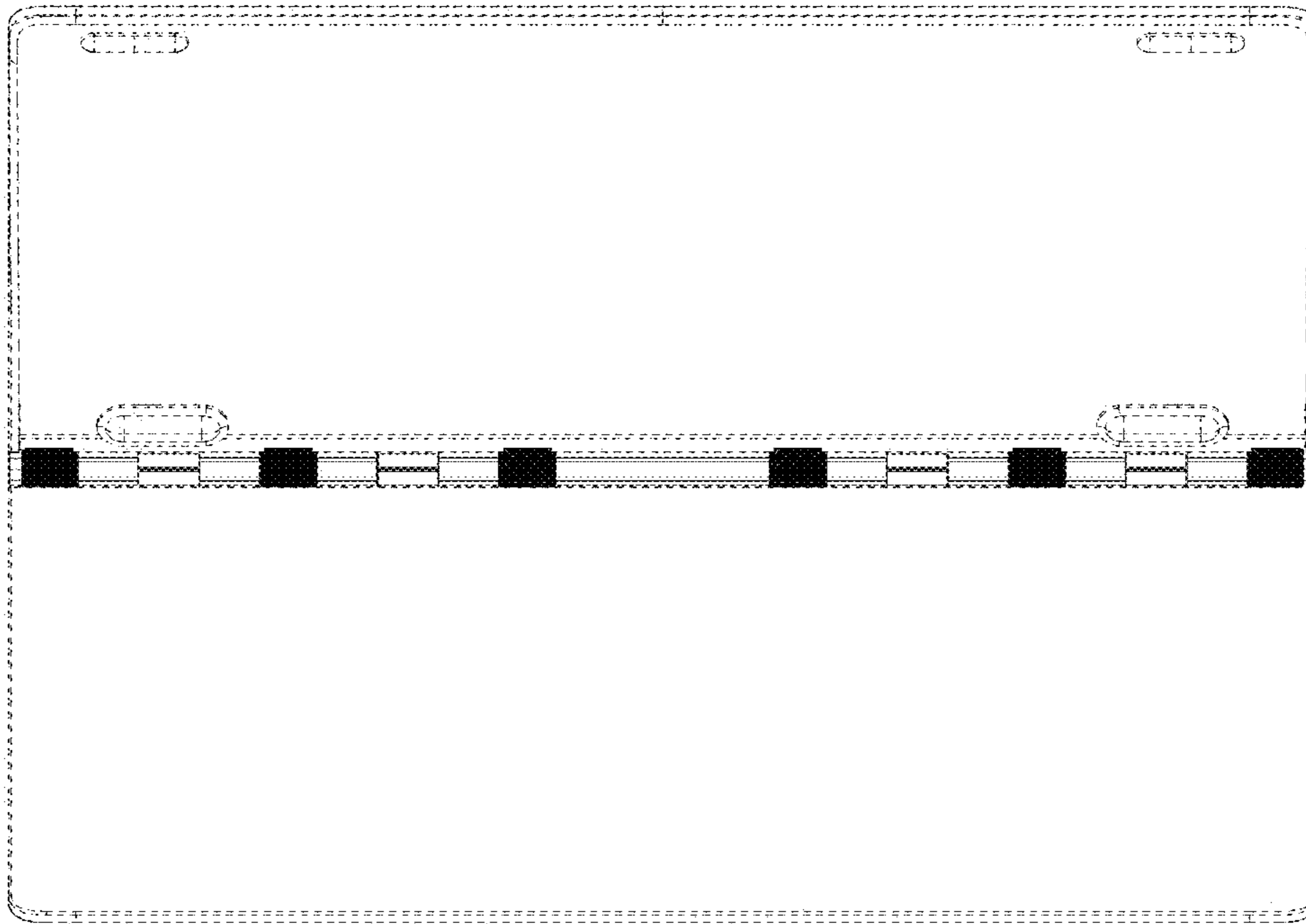

Fig.23

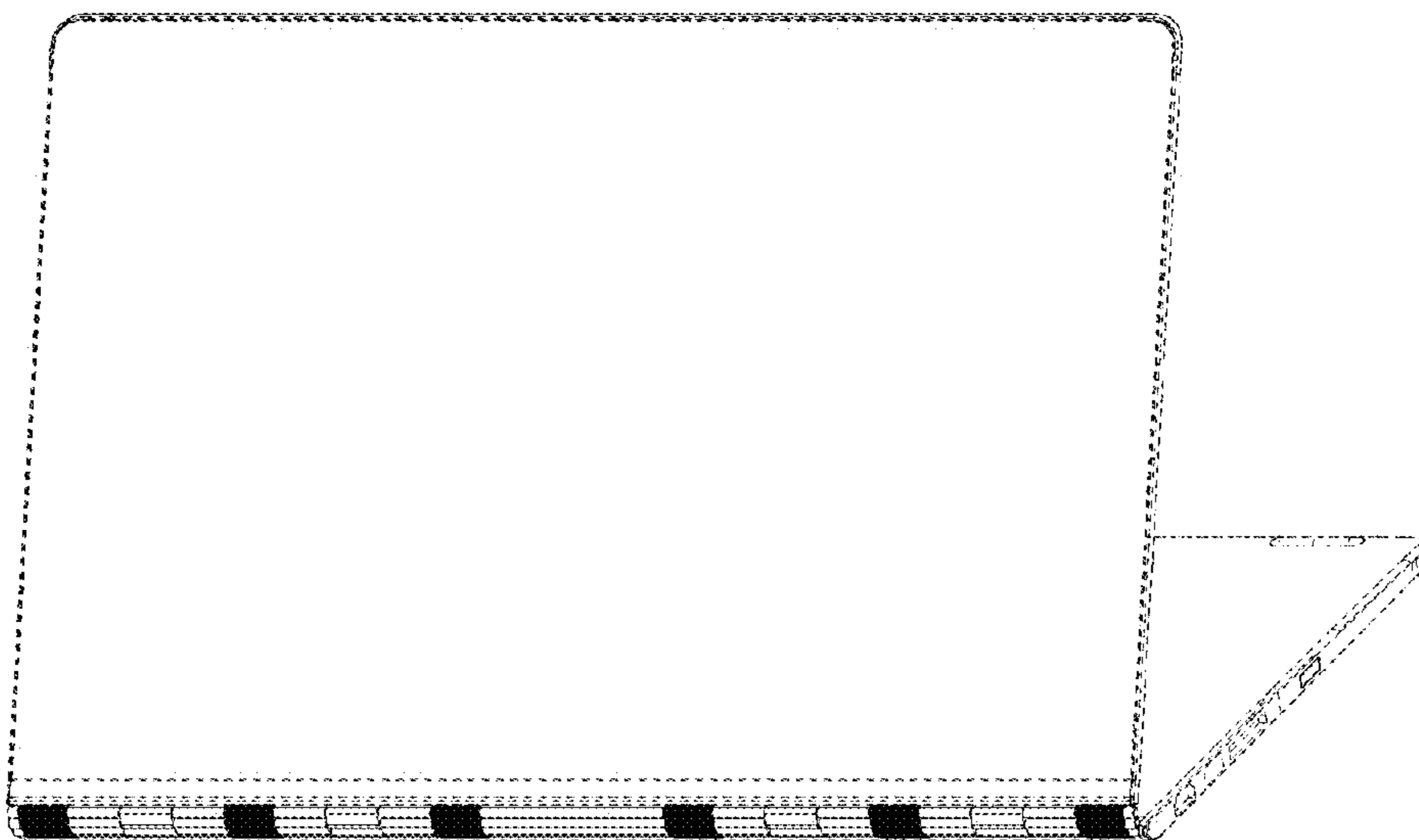

Fig.24

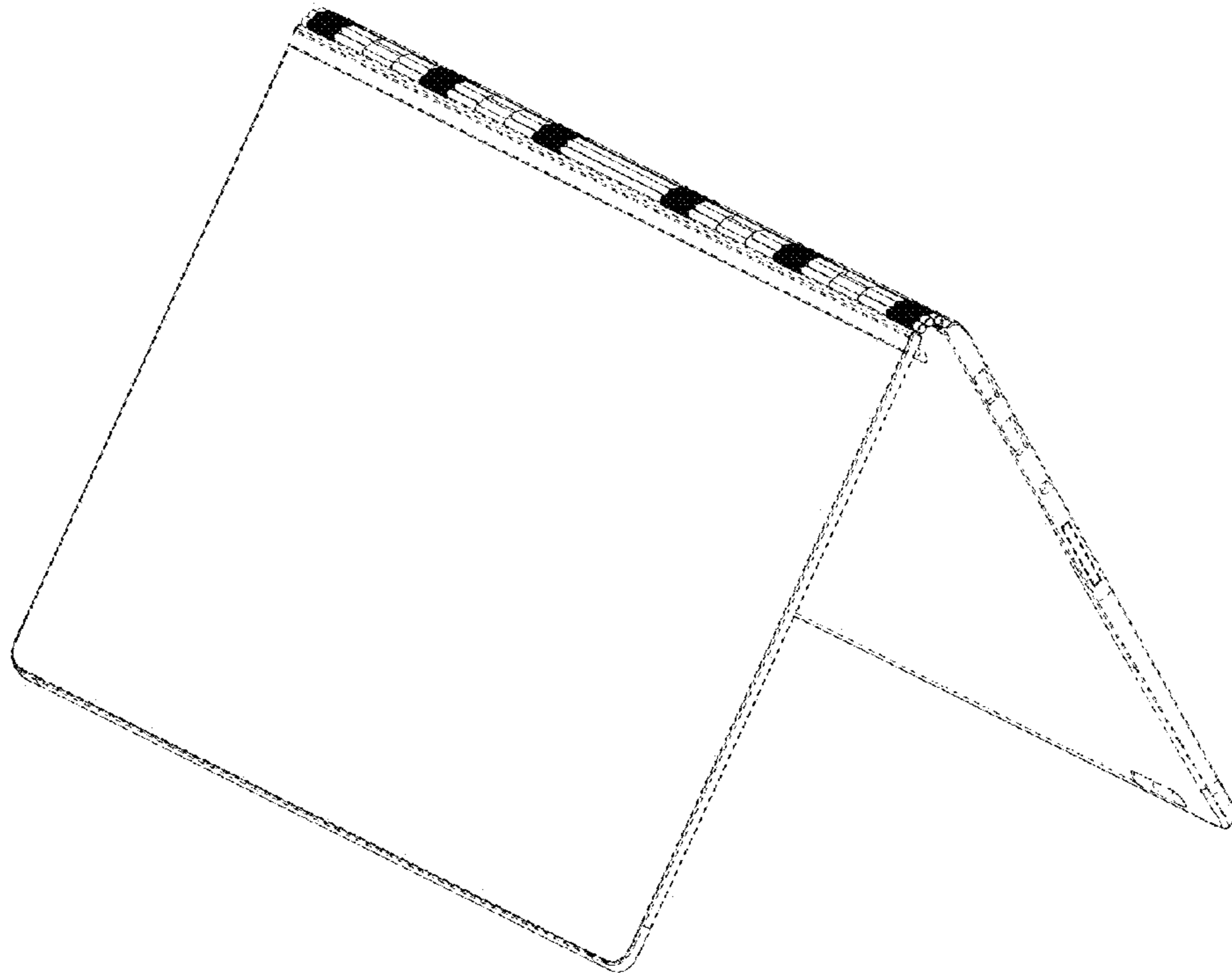

Fig.25

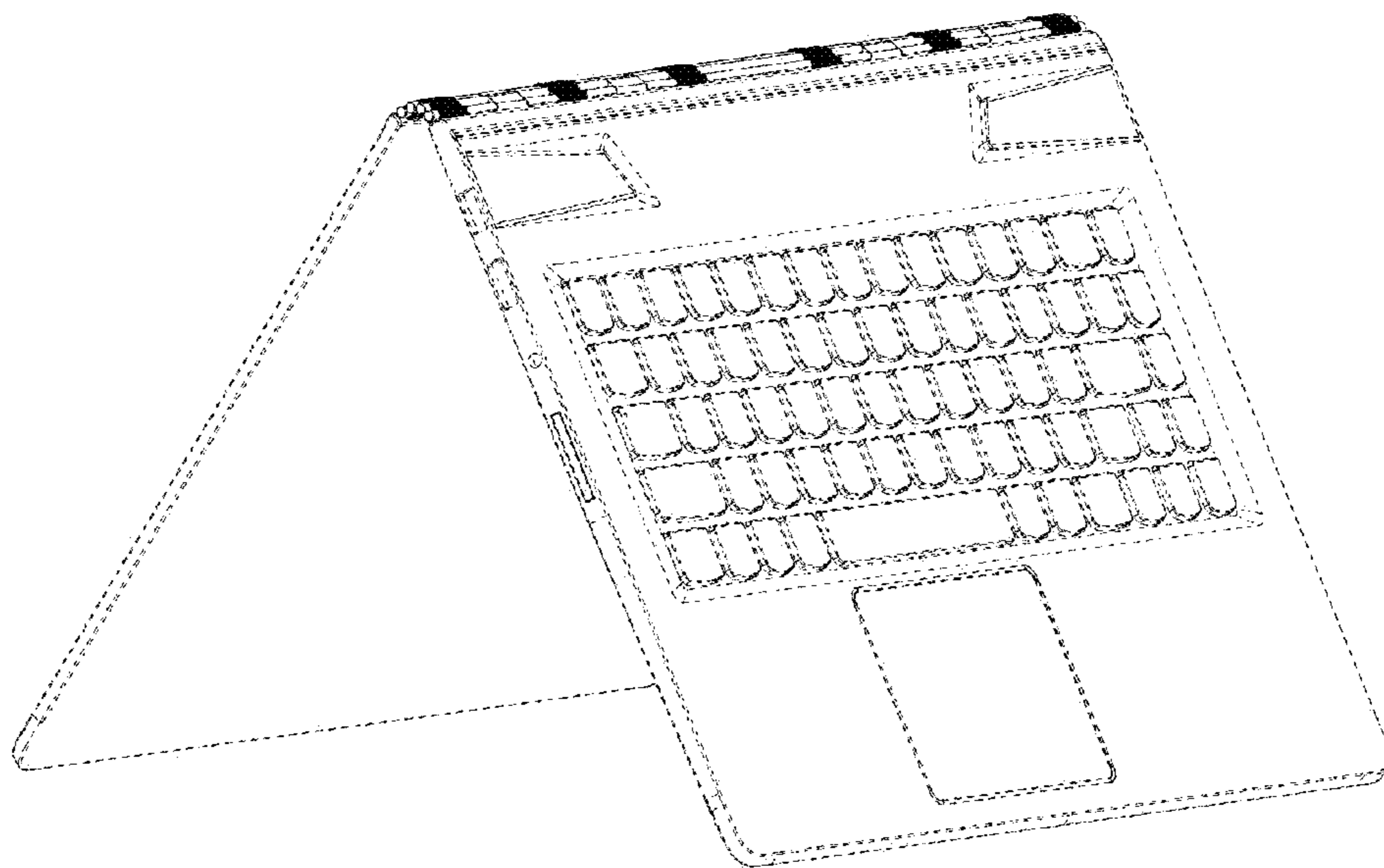

Fig.26

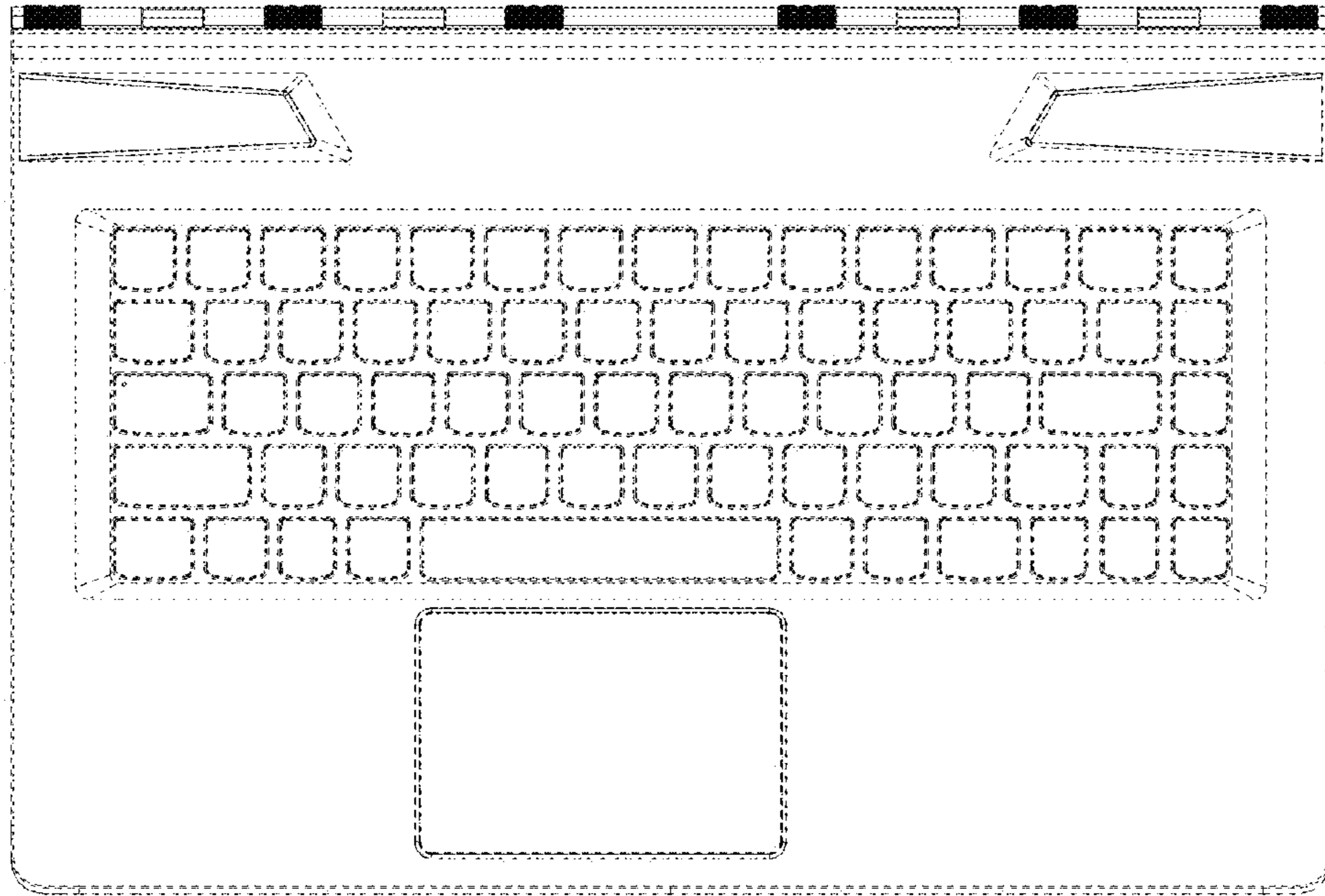

Fig.27

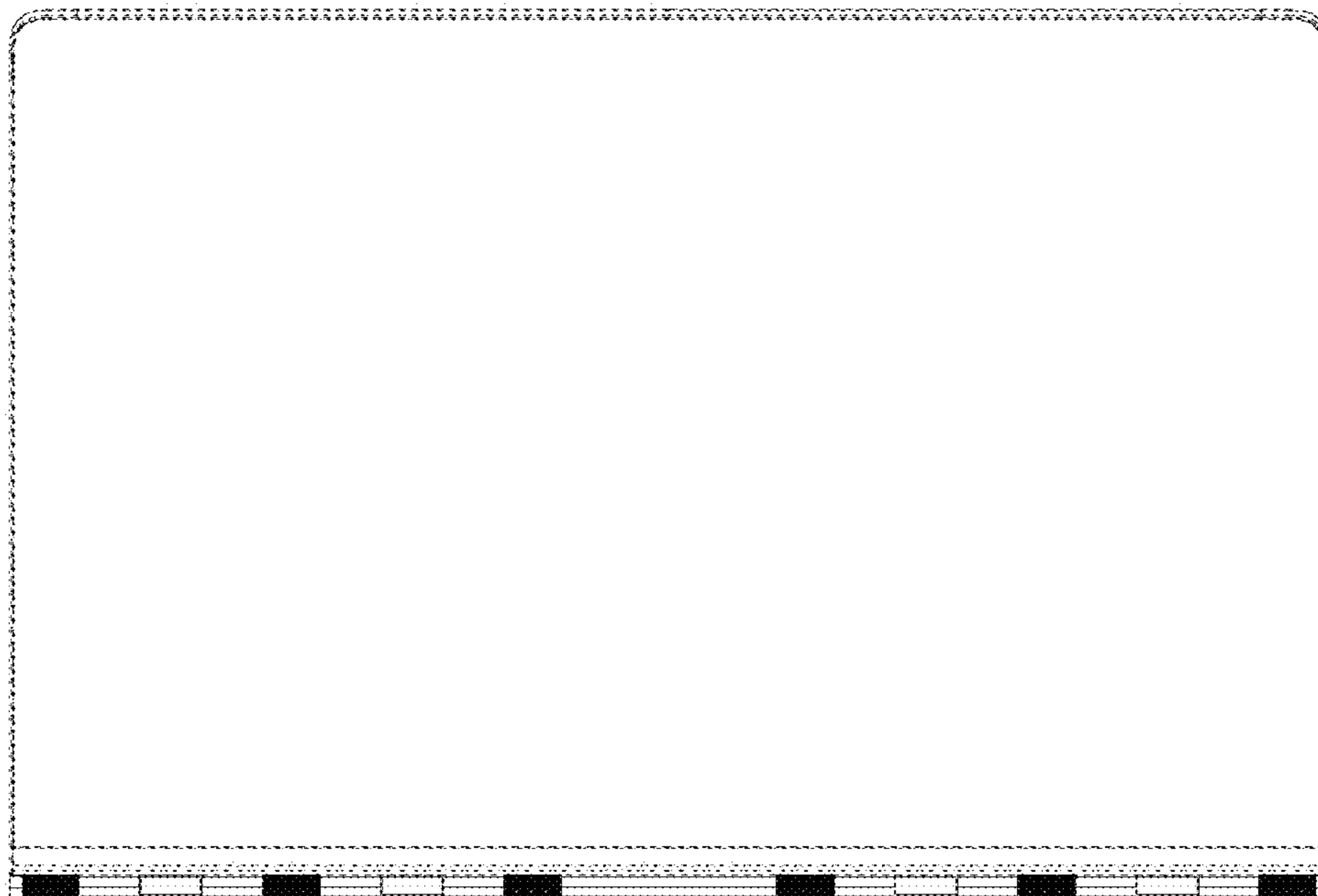

Fig.28

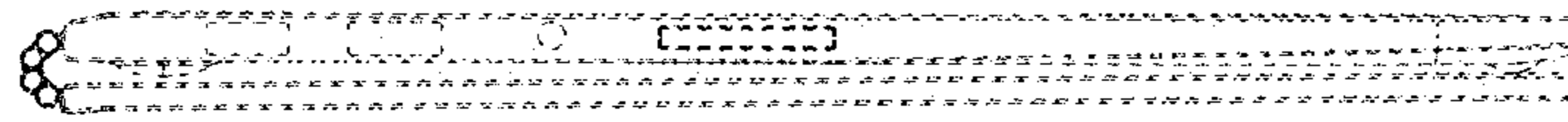

Fig.29

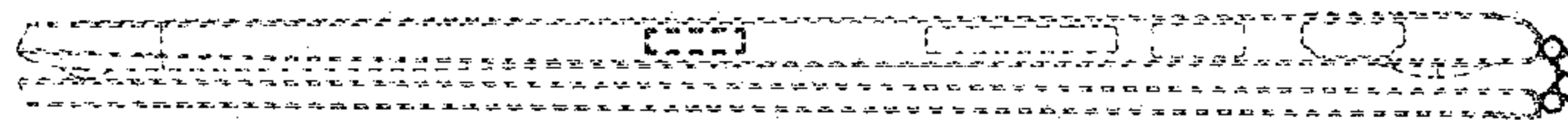

Fig.30

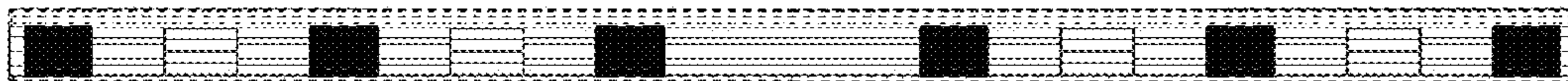

Fig.31

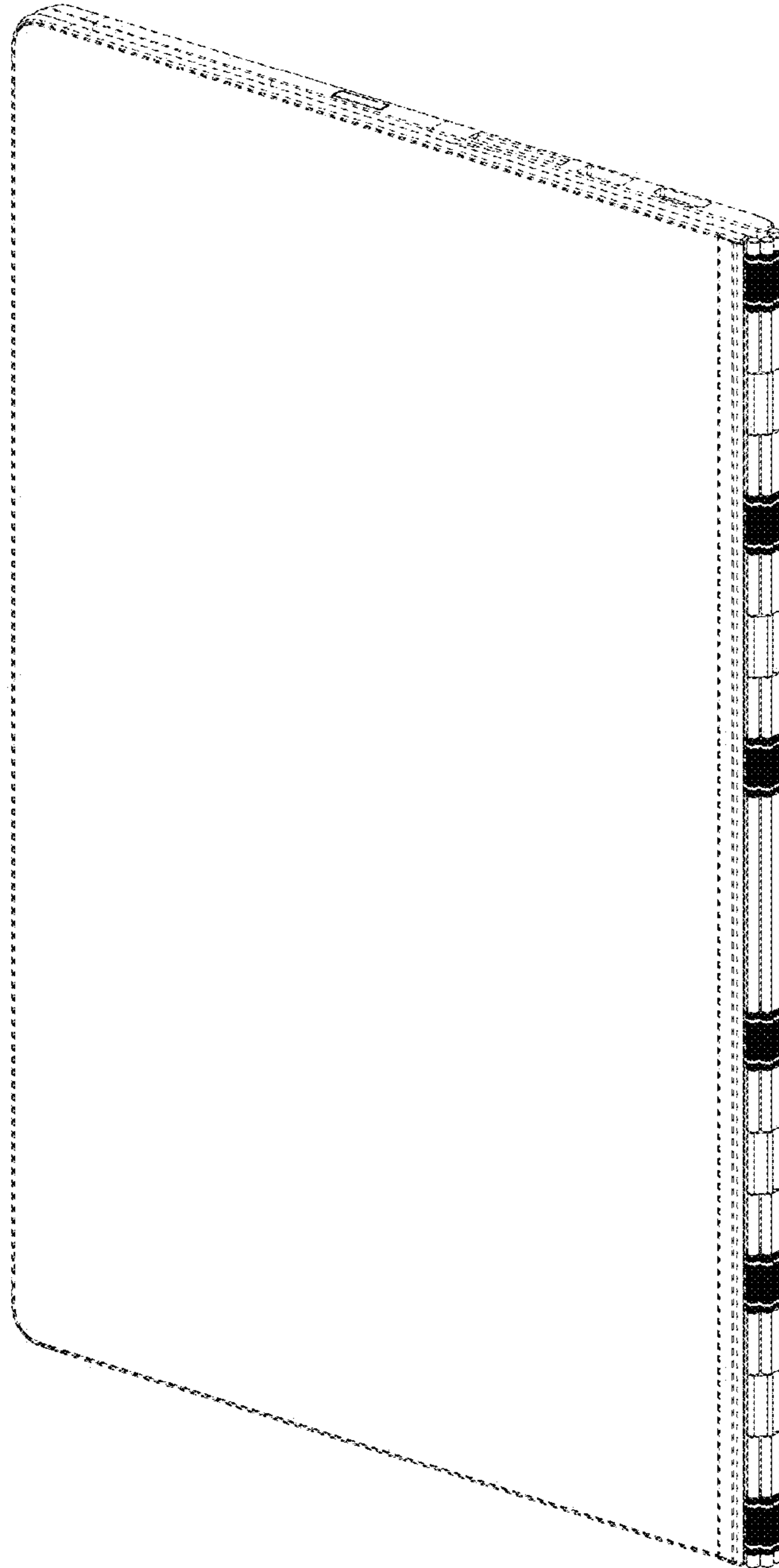

Fig.32