



US00D748086S

(12) **United States Design Patent**
Choe et al.

(10) **Patent No.:** **US D748,086 S**
(45) **Date of Patent:** **** Jan. 26, 2016**

(54) **CASE FOR CELLULAR PHONE**
(71) Applicant: **LG ELECTRONICS INC.**, Seoul (KR)
(72) Inventors: **Sharim Choe**, Seoul (KR); **Kyubong Choi**, Gyeonggi-do (KR); **Joonhyung Kim**, Gyeonggi-do (KR)
(73) Assignee: **LG Electronics Inc.**, Seoul (KR)
(**) Term: **14 Years**
(21) Appl. No.: **29/488,994**
(22) Filed: **Apr. 25, 2014**
(30) **Foreign Application Priority Data**

Nov. 8, 2013 (KR) 30-2013-0056394

(51) **LOC (10) Cl.** **14-03**
(52) **U.S. Cl.**
USPC **D14/250**

(58) **Field of Classification Search**
USPC D14/238.1, 250, 440, 203.3–203.7, 217, D14/240, 248, 251–253, 447, 496; D3/201, D3/218, 247, 269, 273, 301, 303; D13/103, 107–108, 119
CPC A45C 1/06; A45C 11/00; A45C 13/02; A45C 2011/002; A45F 5/02; A45F 2005/026; A45F 2200/0525; A45F 2200/0516; H04B 1/3888; H04M 1/0283; H04M 1/0202
See application file for complete search history.

(56) **References Cited**

U.S. PATENT DOCUMENTS

D597,089 S * 7/2009 Khan D14/250
D603,389 S * 11/2009 Khan D14/250
D619,361 S * 7/2010 Andre D3/269
D625,303 S * 10/2010 Kim D14/250
D646,266 S * 10/2011 Kim D14/250
D662,503 S * 6/2012 Akana D14/439
D674,798 S * 1/2013 Kim D14/440
D675,198 S * 1/2013 Andre D14/250
D682,260 S * 5/2013 Tages D14/250

D685,802 S * 7/2013 Canizares D14/440
D688,251 S * 8/2013 Akana D14/440
D710,838 S * 8/2014 Song D14/250
D711,861 S * 8/2014 Mei D14/250
D712,393 S * 9/2014 Kim D14/250
D714,280 S * 9/2014 Ahn D14/250
D716,286 S * 10/2014 Ahn D14/250
D721,693 S * 1/2015 Lee D14/250
D721,694 S * 1/2015 Lee D14/250
D733,110 S * 6/2015 Lee D14/248
D733,111 S * 6/2015 Kim D14/250
D733,150 S * 6/2015 Sirichai D14/440
D735,183 S * 7/2015 Kim D14/250
D738,364 S * 9/2015 Han D14/248
2012/0244920 A1 * 9/2012 Lee H04B 1/3888
455/575.8
2013/0020214 A1 * 1/2013 Chiou G06F 1/1626
206/320
2014/0030474 A1 * 1/2014 Hsu A45C 11/00
428/99

* cited by examiner

Primary Examiner — Carla Jobe Wright

(74) *Attorney, Agent, or Firm* — Morgan, Lewis & Bockius LLP

(57) **CLAIM**

The ornamental design for a case for cellular phone, as shown and described.

DESCRIPTION

FIG. 1 is a front, left side, perspective view of a case for cellular phone showing our new design;
FIG. 2 is a front view thereof;
FIG. 3 is a rear view thereof;
FIG. 4 is a left side view thereof;
FIG. 5 is a right side view thereof;
FIG. 6 is a top view thereof;
FIG. 7 is a bottom view thereof;
FIG. 8 is a rear, perspective view thereof; and,
FIG. 9 is a perspective view thereof showing an environmental state.

The broken lines are for illustrative purposes only and form no part of the claimed design.

1 Claim, 7 Drawing Sheets

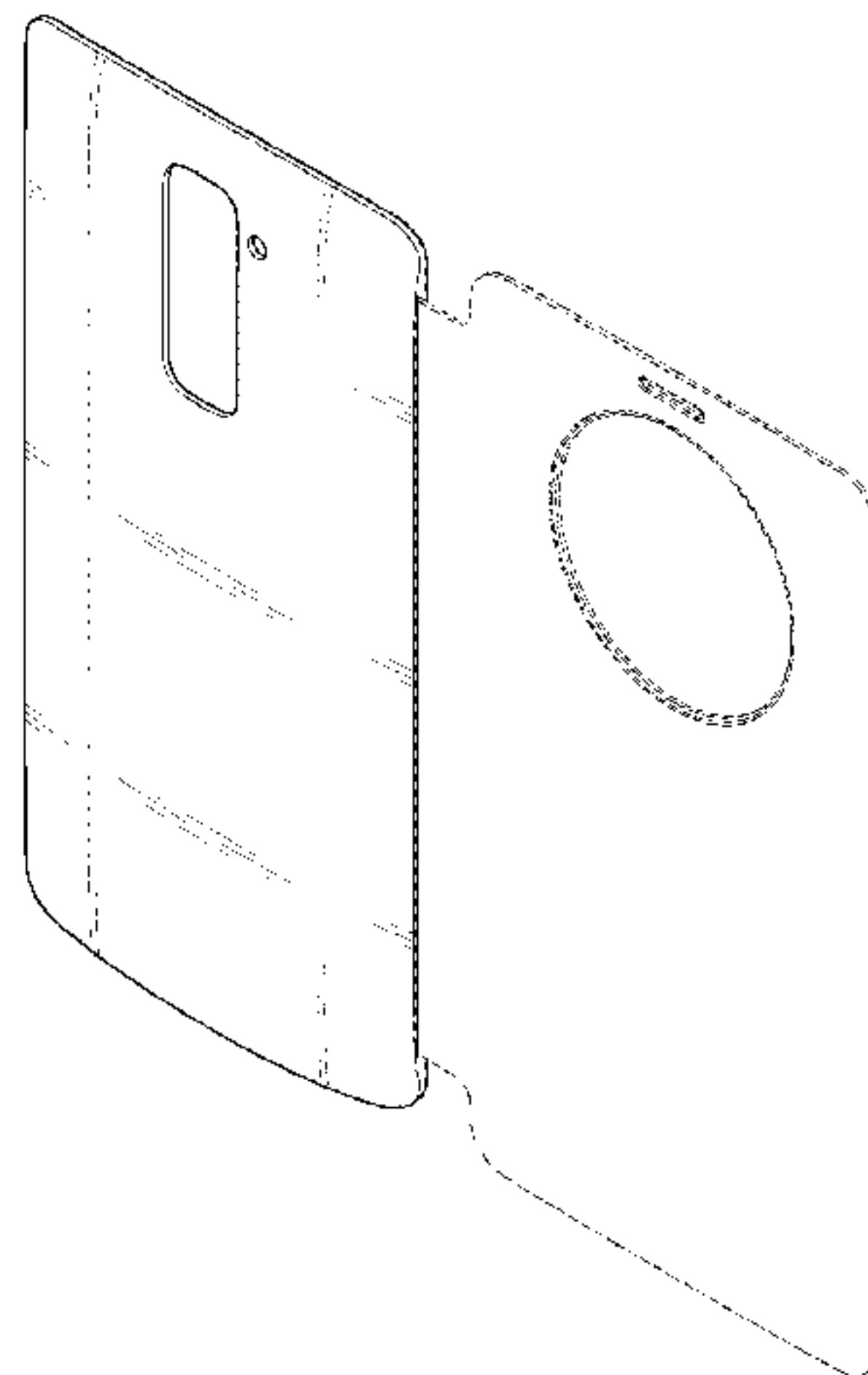

FIG. 1

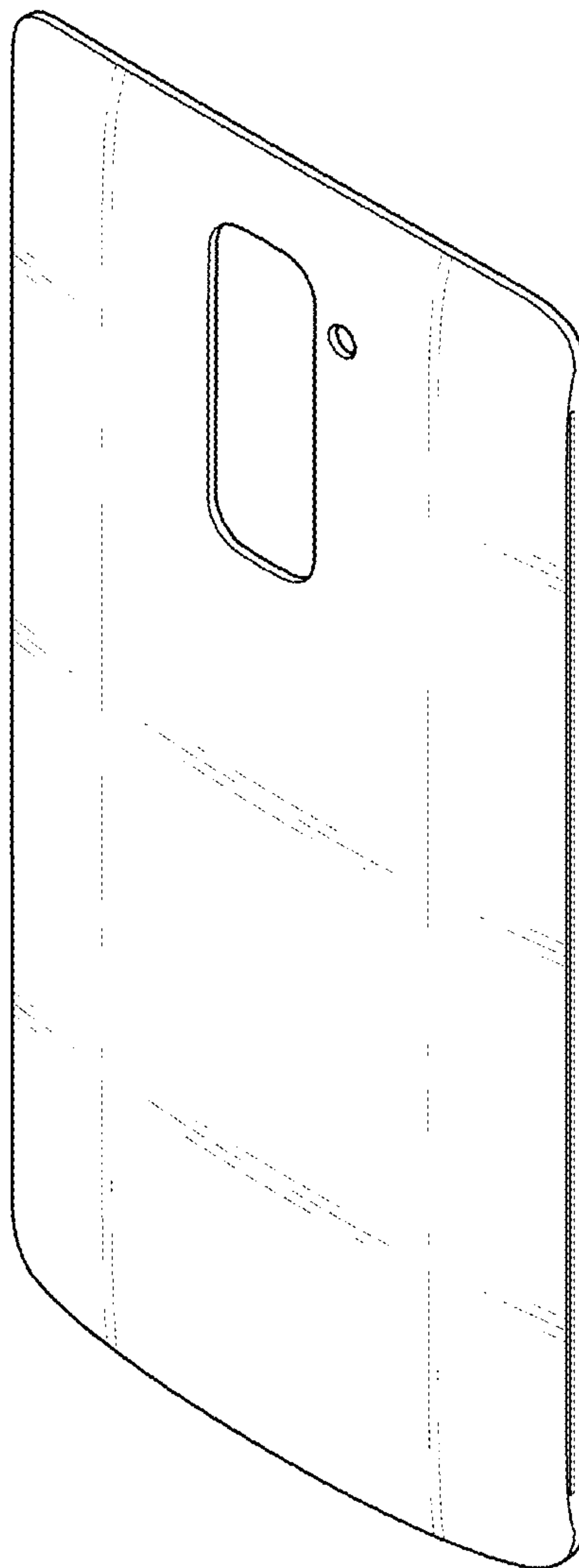

FIG. 2

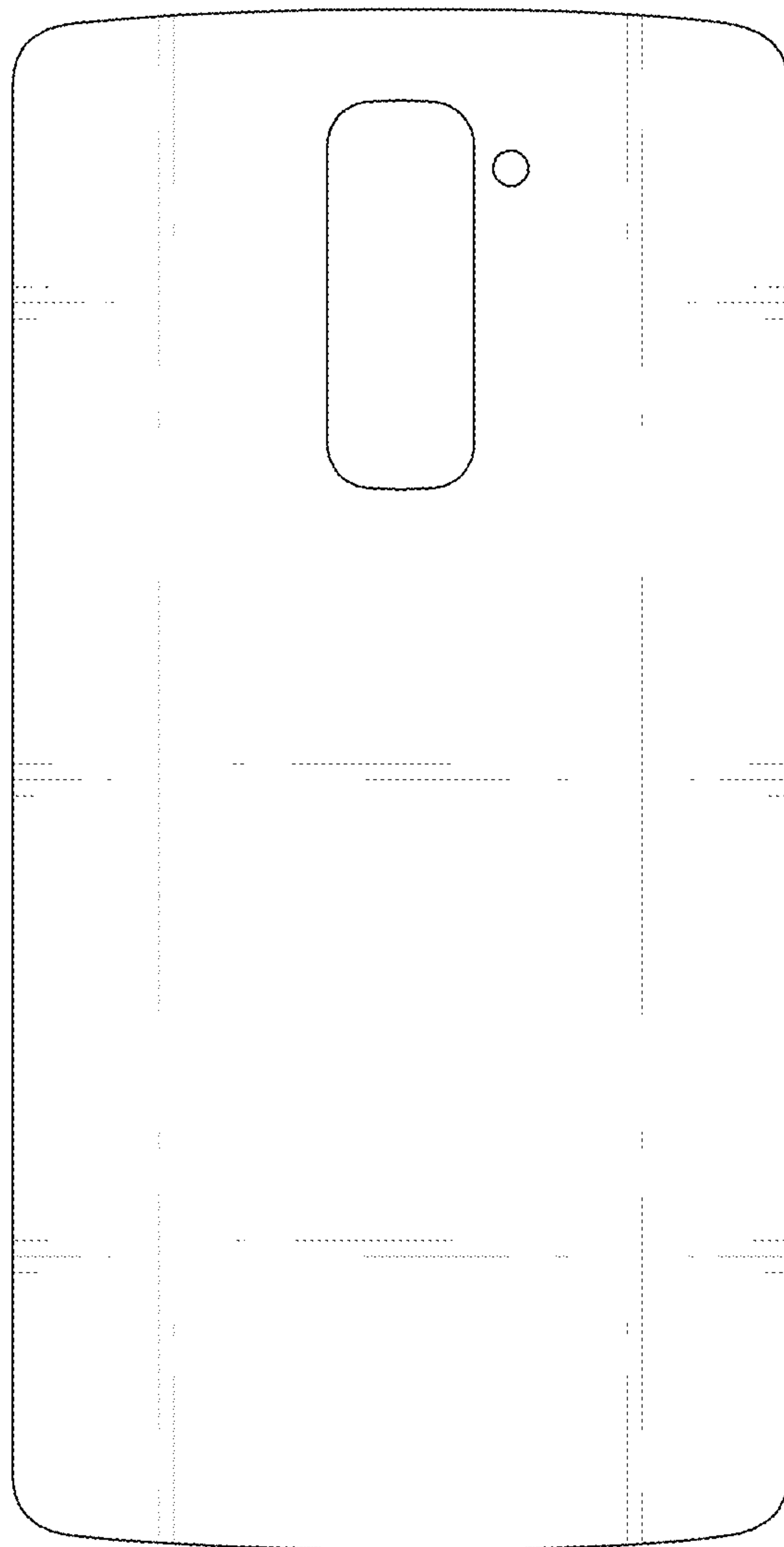

FIG. 3

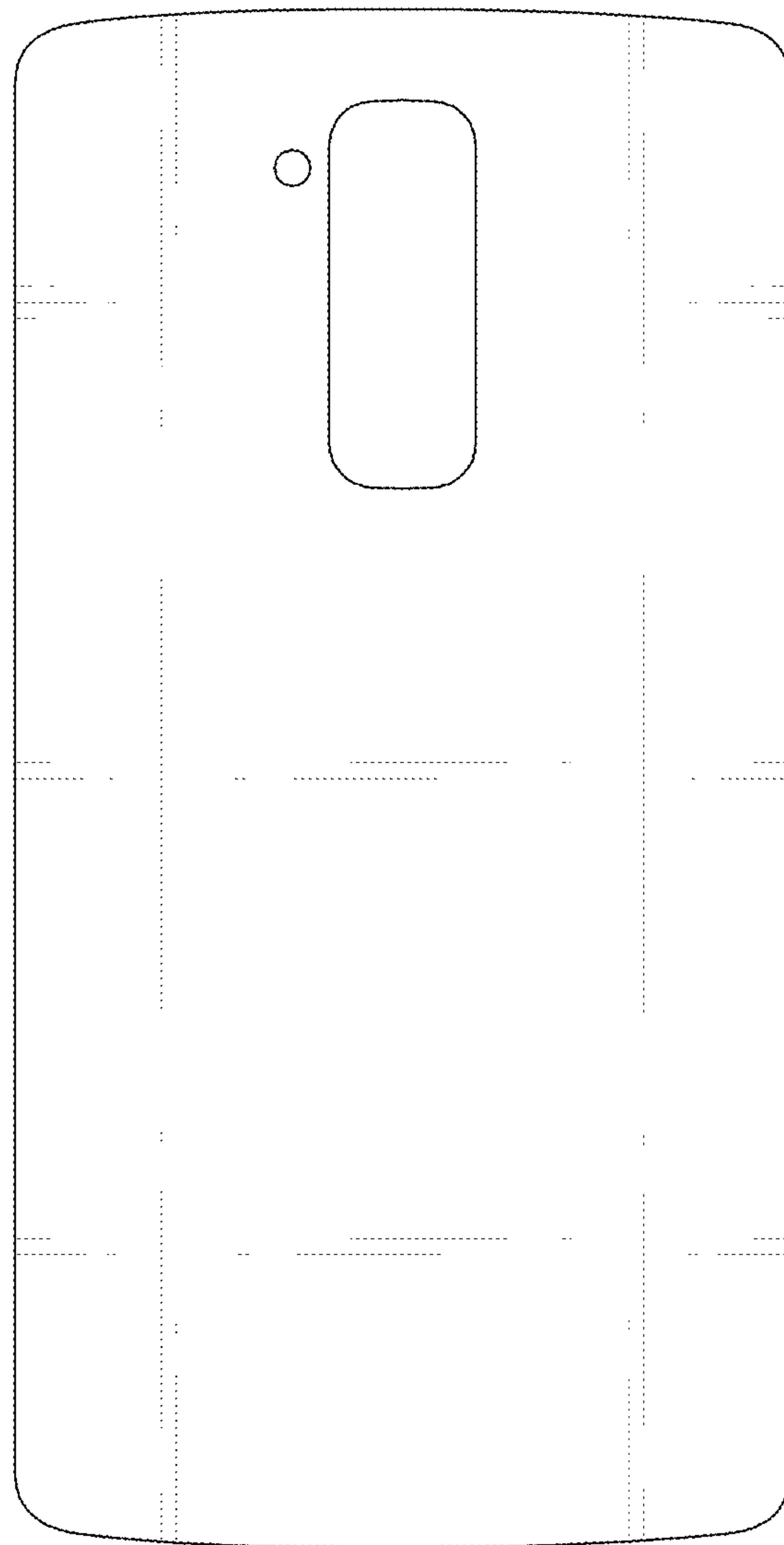

FIG. 4

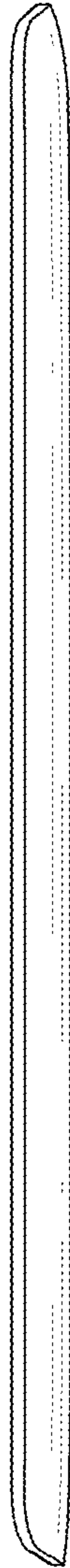

FIG. 5

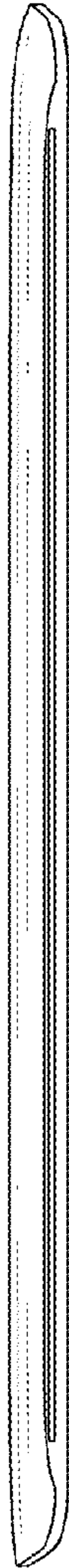

FIG. 6

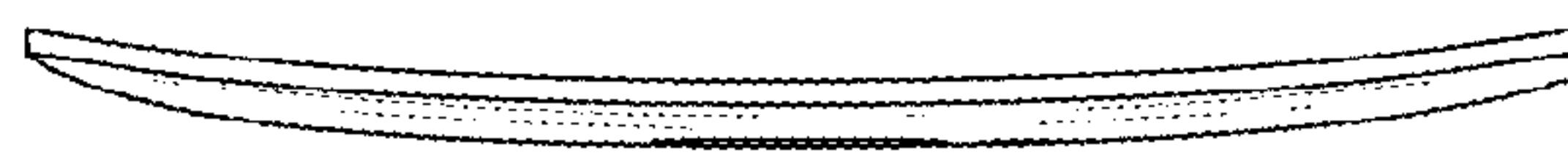

FIG. 7

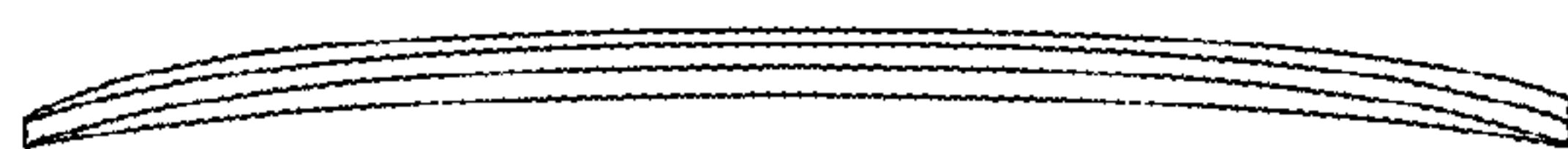

FIG. 8

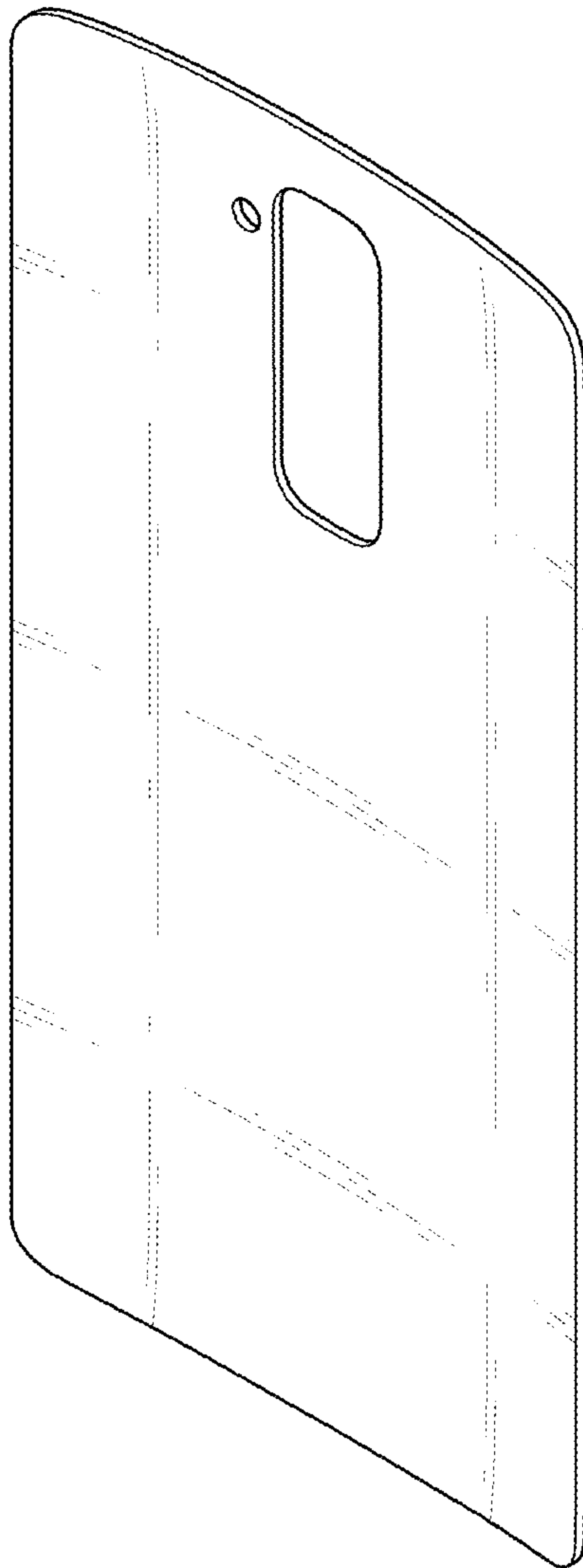

FIG. 9

