



US00D748081S

(12) **United States Design Patent**  
**Chung et al.**

(10) **Patent No.:** **US D748,081 S**  
(45) **Date of Patent:** **\*\* Jan. 26, 2016**

(54) **PORTABLE TERMINAL**

(71) Applicant: **Samsung Electronics Co., Ltd.**,  
Suwon-si (KR)

(72) Inventors: **In-Sik Chung**, Seoul (KR); **Dae-Yeob Park**, Gimpo-si (KR)

(73) Assignee: **Samsung Electronics Co., Ltd.**,  
Suwon-si (KR)

(\*\*) Term: **14 Years**

(21) Appl. No.: **29/464,566**

(22) Filed: **Aug. 19, 2013**

(30) **Foreign Application Priority Data**

Feb. 18, 2013 (KR) ..... 30-2013-0008373

(51) **LOC (10) Cl.** ..... **14-03**

(52) **U.S. Cl.**  
USPC ..... **D14/240**; D14/138 G

(58) **Field of Classification Search**  
USPC ..... D14/138 G, 138 AD, 138 R, 496, 203.1,  
D14/203.3, 203.5, 203.7, 248, 218, 341,  
D14/138 AC, 250; D21/517, 329, 331;  
D13/168; D10/65, 78; 455/575.1,  
455/556.1, 556.2; 379/433.01, 433.04;  
361/679.3, 679.56

CPC ..... H04M 1/02; H04M 1/0202; H04M  
1/0202-1/035; H04M 1/0235; H04M 1/0237;  
H04M 1/0239; H04M 2250/22

See application file for complete search history.

(56) **References Cited**

**U.S. PATENT DOCUMENTS**

D640,663 S \* 6/2011 Arnholt et al. .... D14/138 G  
D646,248 S \* 10/2011 Lee ..... D14/138 G  
D655,269 S \* 3/2012 Kim ..... D14/138 G  
D661,277 S \* 6/2012 Kim ..... D14/138 G  
D668,628 S \* 10/2012 Ha et al. .... D14/138 G  
D669,447 S \* 10/2012 Hong ..... D14/138 G  
D671,086 S \* 11/2012 Yu et al. .... D14/138 G

D671,089 S \* 11/2012 Joung et al. .... D14/138 G  
D676,400 S \* 2/2013 Kitamura ..... D14/138 G  
D677,644 S \* 3/2013 Park ..... D14/138 G  
D687,793 S \* 8/2013 Park ..... D14/138 G  
D687,795 S \* 8/2013 Kim et al. .... D14/138 AD

(Continued)

**OTHER PUBLICATIONS**

Samsung G910S Galaxy Round telephone, announced Oct. 2013, [online], [site visited Nov. 31, 2014]. Available from Internet, <URL:http://www.gsmarena.com/samsung\_galaxy\_round\_g910s-5766.php>.\*

Acer Liquid C1 telephone, announced Jan. 2013, [online], [site visited Nov. 31, 2014]. Available from Internet, <URL:http://www.gsmarena.com/acer\_liquid\_c1-5276.php>.\*

LG Optimus G Pro E985 telephone, announced Feb. 2013, [online], [site visited Nov. 31, 2014]. Available from Internet, <URL:http://www.gsmarena.com/lg\_optimus\_g\_pro\_e985-5254.php>.\*

(Continued)

*Primary Examiner* — Rosemary K Tarcza

*Assistant Examiner* — Sanjeev Paul

(74) *Attorney, Agent, or Firm* — NSIP Law

(57) **CLAIM**

The ornamental design for a portable terminal, as shown and described.

**DESCRIPTION**

FIG. 1 is a front perspective view of a portable terminal showing our new design;  
FIG. 2 is a front view thereof;  
FIG. 3 is a rear view thereof;  
FIG. 4 is a left-side view thereof;  
FIG. 5 is a right-side view thereof;  
FIG. 6 is a top view thereof;  
FIG. 7 is a bottom view thereof; and,  
FIG. 8 is an enlarged view of the portion A encircled in FIG. 5.

The broken lines shown in the figures that are immediately adjacent to the shaded areas and define regions that are consistently unshaded, represent bounds of the claim, while all other broken lines, including those within the broken line boundaries and those that have been shaded through, are directed to non-claimed environment; the broken lines form no part of the claimed design.

**1 Claim, 6 Drawing Sheets**

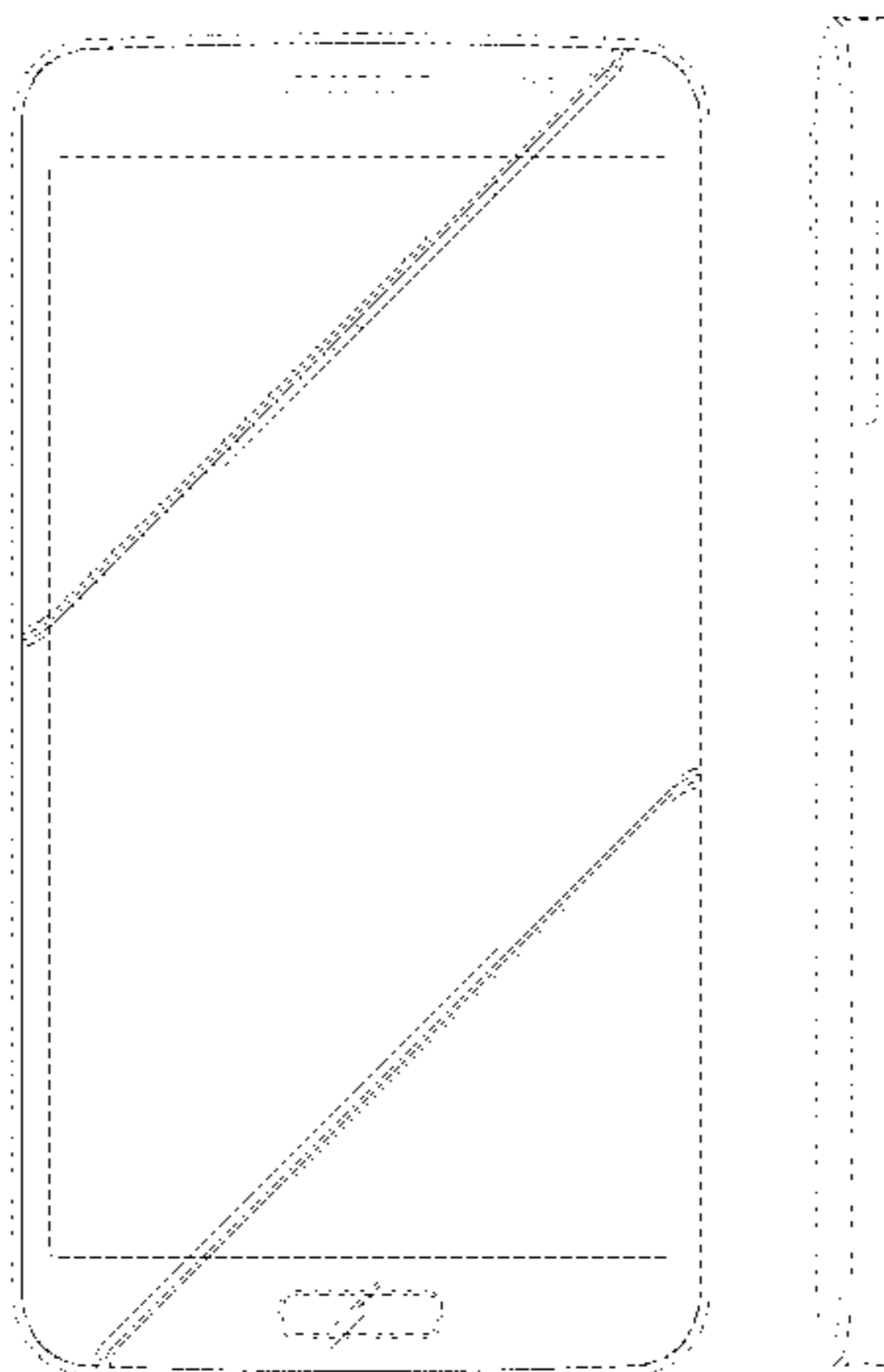

(56)

**References Cited**

U.S. PATENT DOCUMENTS

D694,214	S	*	11/2013	Kim et al.	.....	D14/138	G
D695,247	S	*	12/2013	Kim et al.	.....	D14/138	G
D697,492	S	*	1/2014	Minamide et al.	.....	D14/138	G
D698,782	S	*	2/2014	Hong	.....	D14/341	
D699,206	S	*	2/2014	Kim	.....	D14/138	G
D699,207	S	*	2/2014	Kim	.....	D14/138	G
D702,203	S	*	4/2014	Son	.....	D14/138	G
D702,661	S	*	4/2014	Oh et al.	.....	D14/138	G
D708,159	S	*	7/2014	Kim	.....	D14/138	G
D708,160	S	*	7/2014	Wooseung	.....	D14/138	G
D710,812	S	*	8/2014	Yonghee	.....	D14/138	G
D711,339	S	*	8/2014	Yang	.....	D14/138	G
D712,861	S	*	9/2014	Fujimura et al.	.....	D14/138	G
D716,746	S	*	11/2014	Du et al.	.....	D14/138	G

OTHER PUBLICATIONS

Samsung Galaxy Grand 2 telephone, announced Nov. 2013, [online], [site visited Dec. 12, 2014]. Available from Internet, <URL:[http://www.gsmarena.com/samsung\\_galaxy\\_grand\\_2-5862.php](http://www.gsmarena.com/samsung_galaxy_grand_2-5862.php)>.\*

Samsung G3812B Galaxy S3 Slim telephone, announced Mar. 2014, [online], [site visited Dec. 12, 2014]. Available from Internet, <URL:[http://www.gsmarena.com/samsung\\_g3812b\\_galaxy\\_s3\\_slim-6209.php](http://www.gsmarena.com/samsung_g3812b_galaxy_s3_slim-6209.php)>.\*

LG G Pro Lite Dual telephone, announced Oct. 2013, [online], [site visited Dec. 12, 2014]. Available from Internet, <URL:[http://www.gsmarena.com/lg\\_g\\_pro\\_lite\\_dual-5736.php](http://www.gsmarena.com/lg_g_pro_lite_dual-5736.php)>.\*

Motorola Atrix 4G telephone, announced Nov. 2011, [online], [site visited Jan. 5, 2015]. Available from Internet, <URL:[http://www.gsmarena.com/motorola\\_atrix\\_4g-3708.php](http://www.gsmarena.com/motorola_atrix_4g-3708.php)>.\*

\* cited by examiner

FIG. 1

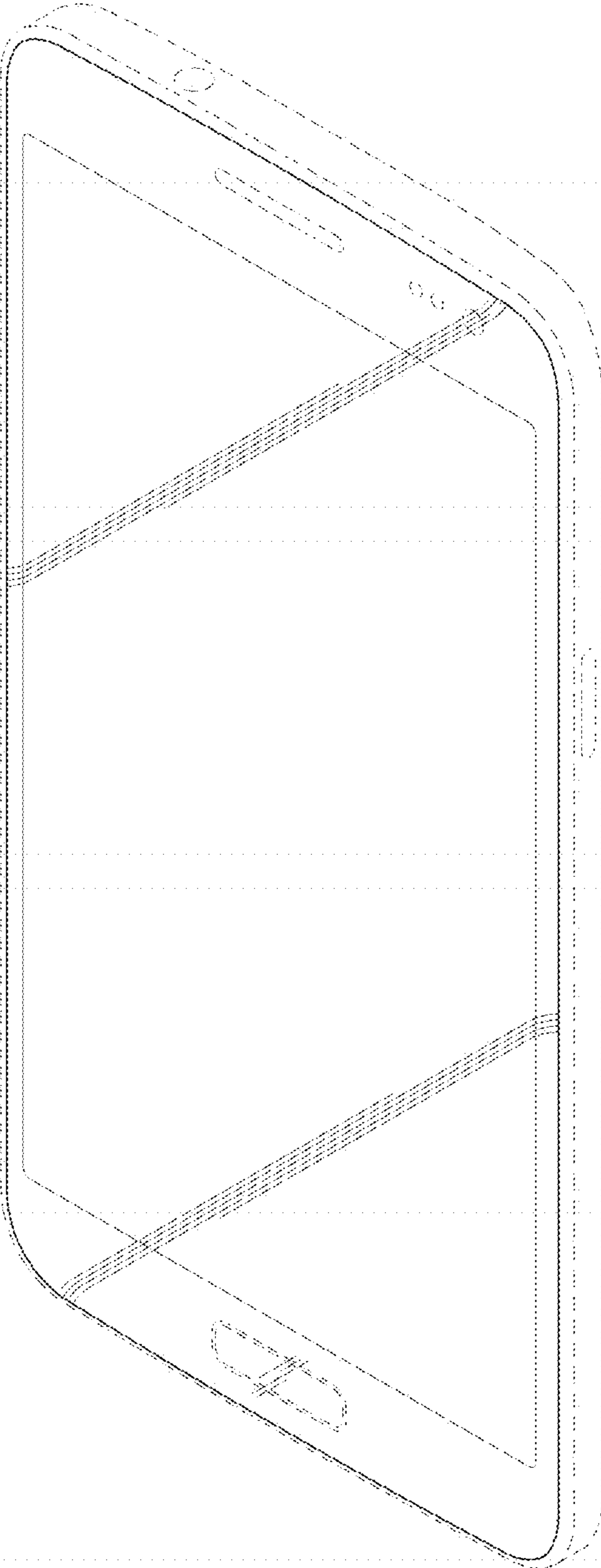

FIG.2

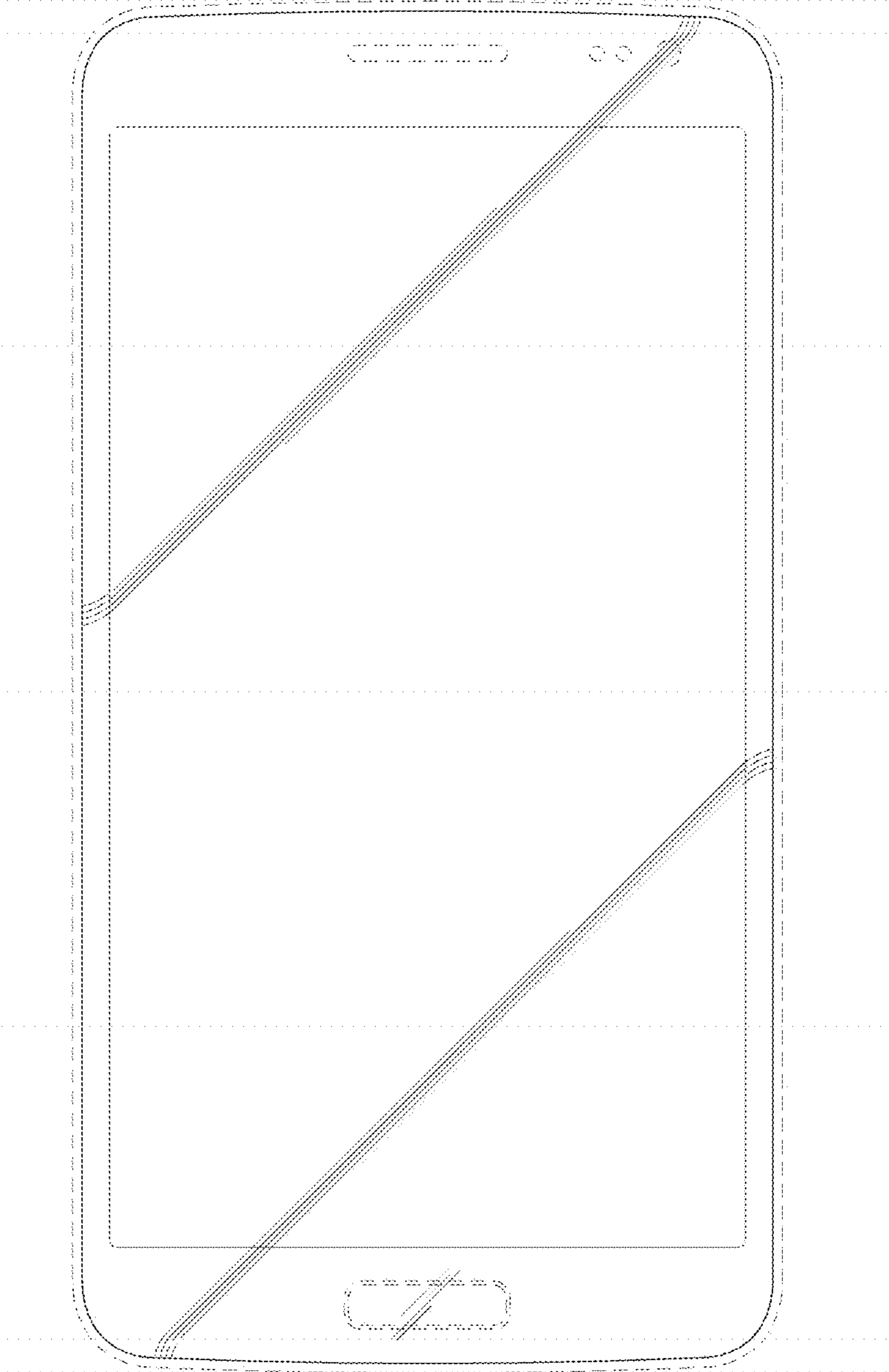

FIG.3

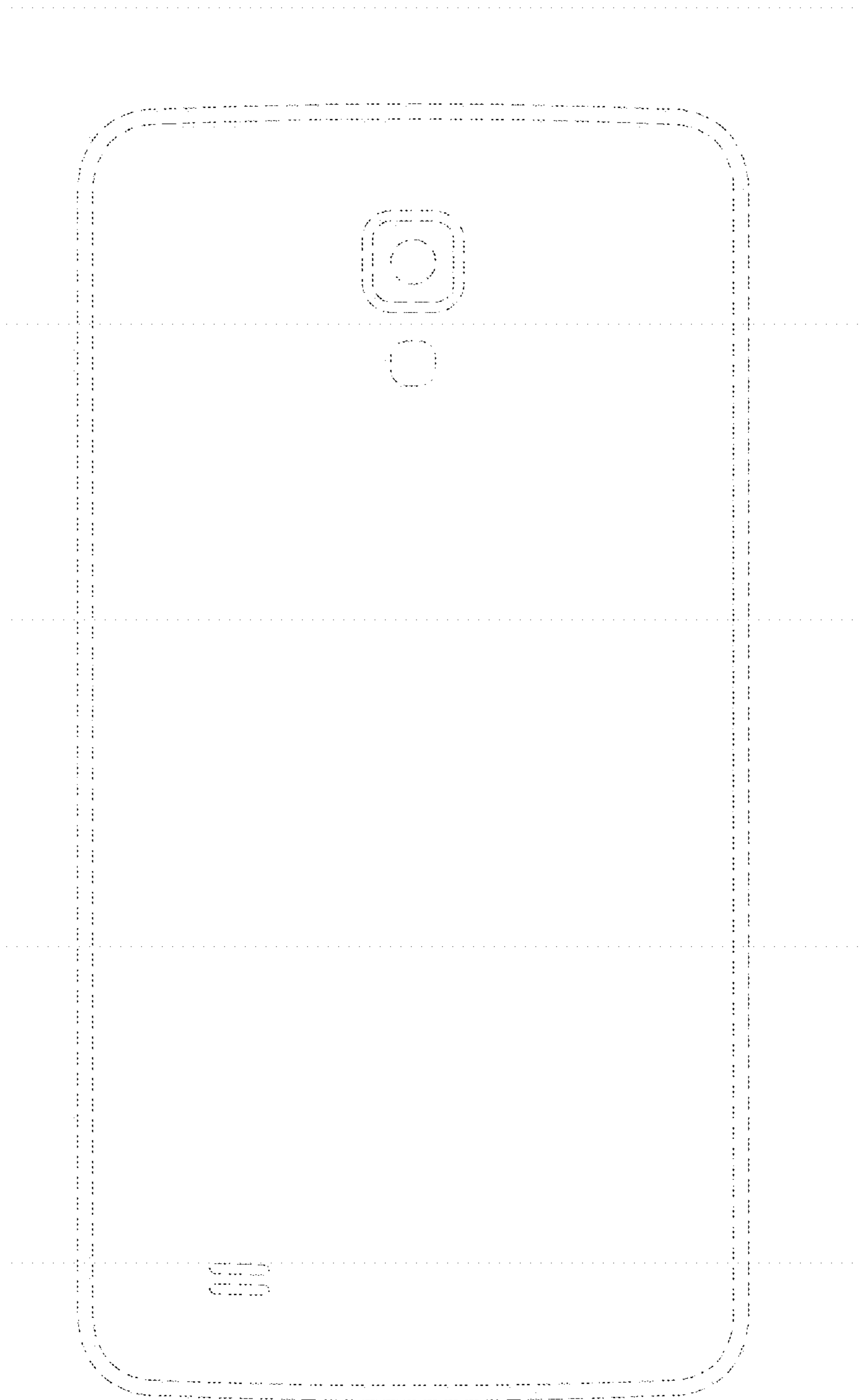

FIG.4

FIG.5

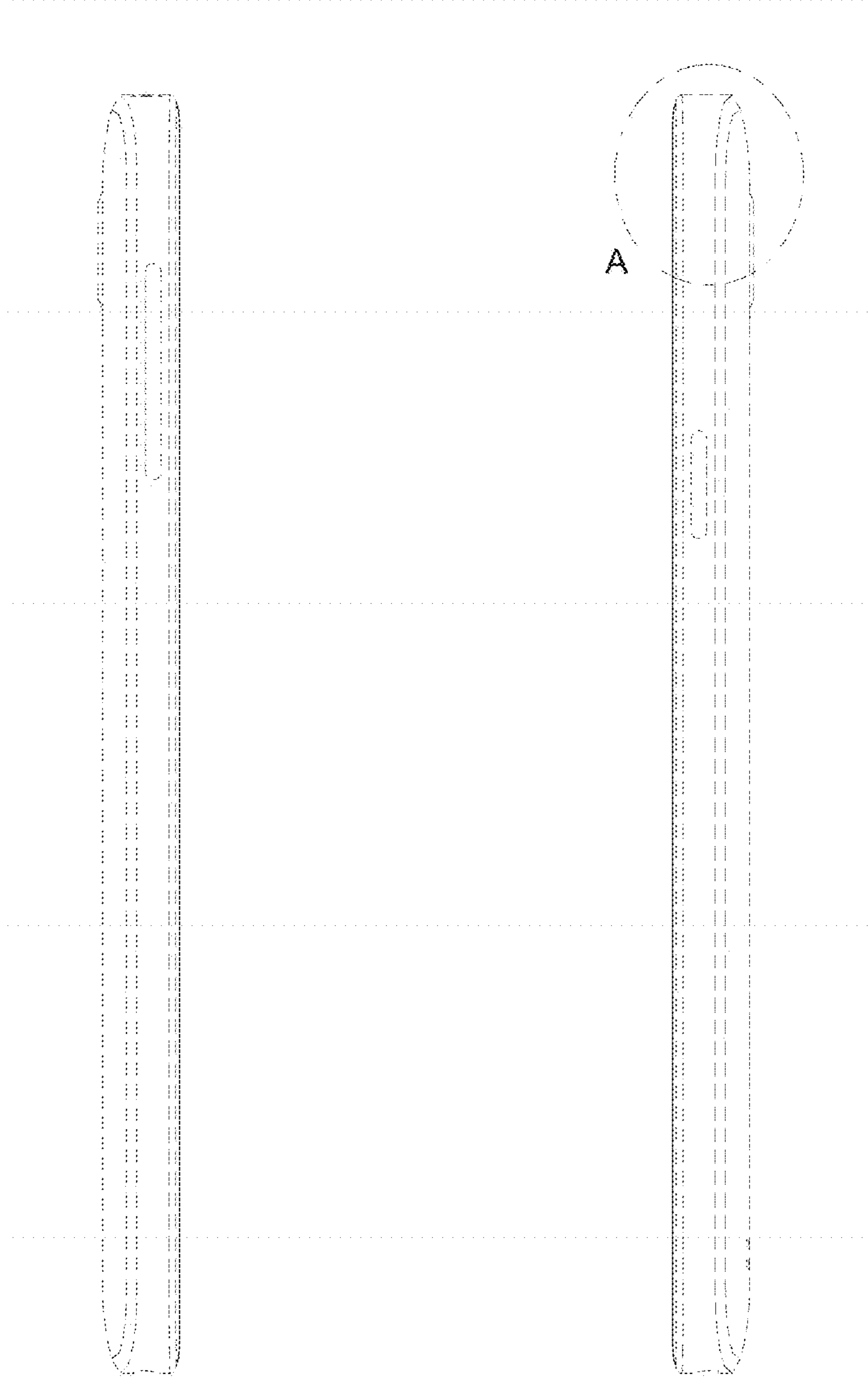

FIG.6

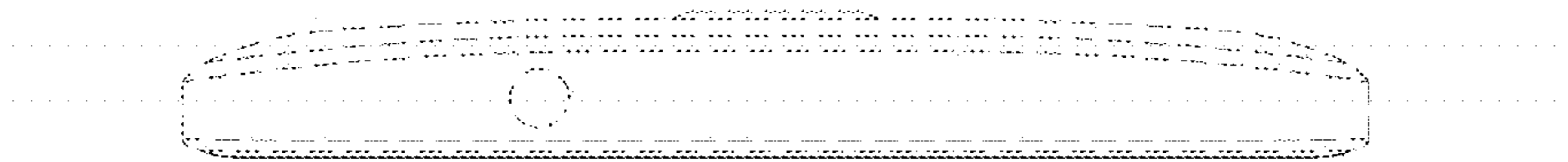

FIG.7

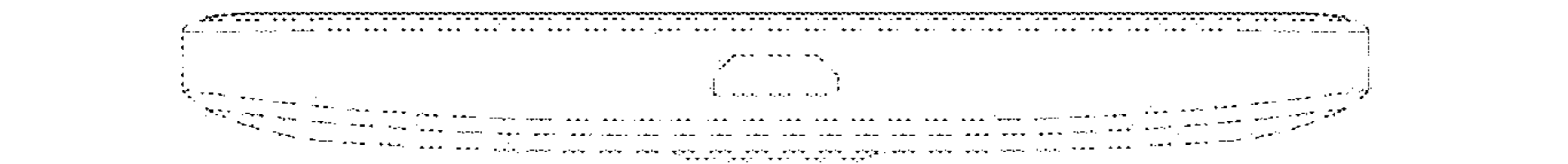

FIG.8

