



US00D748075S

(12) **United States Design Patent**  
**McManigal**

(10) **Patent No.:** **US D748,075 S**  
(45) **Date of Patent:** **\*\* Jan. 26, 2016**

(54) **AUDIO DEVICE**

(71) Applicant: **Scott McManigal**, Irvine, CA (US)

(72) Inventor: **Scott McManigal**, Irvine, CA (US)

(73) Assignee: **Vizio Inc**, Irvine, CA (US)

(\*\*) Term: **14 Years**

(21) Appl. No.: **29/499,930**

(22) Filed: **Aug. 20, 2014**

(51) **LOC (10) Cl.** ..... **14-03**

(52) **U.S. Cl.**  
USPC ..... **D14/214**

(58) **Field of Classification Search**  
USPC ..... D14/167, 168, 170–172, 188, 194–196,  
D14/204, 207, 209.1, 210–216, 219, 221,  
D14/222, 224, 496; 181/143, 144, 147, 148,  
181/150, 153, 157, 198, 199; 381/300–303,  
381/306, 332, 333, 336, 345, 361–364,  
381/386–388; 369/6–12  
CPC .... B60R 11/0217; G06F 1/1688; H04M 1/03;  
H04M 1/035; H04R 1/02; H04R 1/06; H04R  
1/021; H04R 1/025; H04R 1/026; H04R  
1/028; H04R 1/105; H04R 1/323; H04R  
1/403; H04R 1/2803; H04R 1/2834; H04R  
5/02; H04R 7/20; H04R 9/06; H04R 9/025;  
H04R 2201/021; H04R 2400/00; H04R  
2400/07; H04R 2499/11; H04R 2499/13;  
H04R 2499/15; H04S 3/00; H04S 7/30  
See application file for complete search history.

(56) **References Cited**

U.S. PATENT DOCUMENTS

D582,416 S *	12/2008	Duarte et al. ....	D14/434
D597,529 S *	8/2009	Tan et al. ....	D14/214
D620,921 S *	8/2010	Skurdal ....	D14/209.1
D641,338 S *	7/2011	Chen ....	D14/209.1
D672,747 S *	12/2012	Khoo et al. ....	D14/214
D676,413 S *	2/2013	Poandl ....	D14/171
D677,244 S *	3/2013	Funayama ....	D14/209.1
D681,604 S *	5/2013	Funayama ....	D14/209.1
D726,143 S *	4/2015	Cheng ....	D14/197
D726,153 S *	4/2015	Chang ....	D14/215

\* cited by examiner

*Primary Examiner* — Keli L Hill

(74) *Attorney, Agent, or Firm* — Law Office of Scott C Harris, Inc

(57) **CLAIM**

I claim the ornamental design for an audio device, as shown and described.

**DESCRIPTION**

FIG. 1 shows a front perspective view of the audio device; FIG. 2 shows a front view of the audio device; FIG. 3 shows a rear view of the audio device; FIG. 4 shows a first side view of the audio device; FIG. 5 shows a second side view of the audio device; FIG. 6 shows a top view of the audio device; and, FIG. 7 shows a bottom view of the audio device. The portions of the audio device shown in broken lines form no part of the claimed design.

**1 Claim, 6 Drawing Sheets**

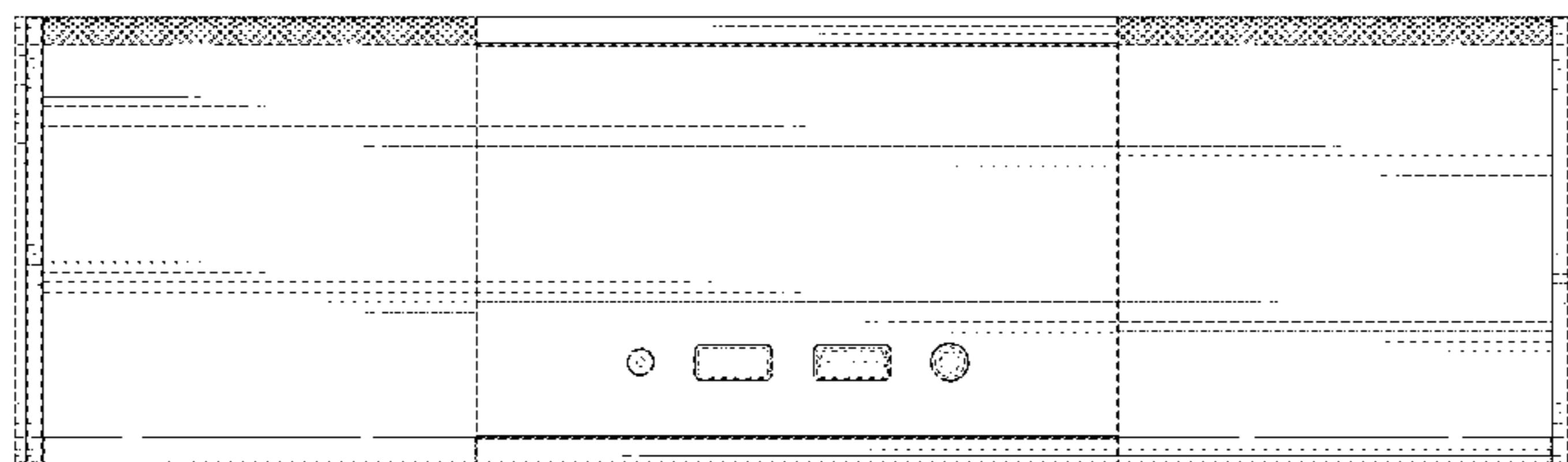
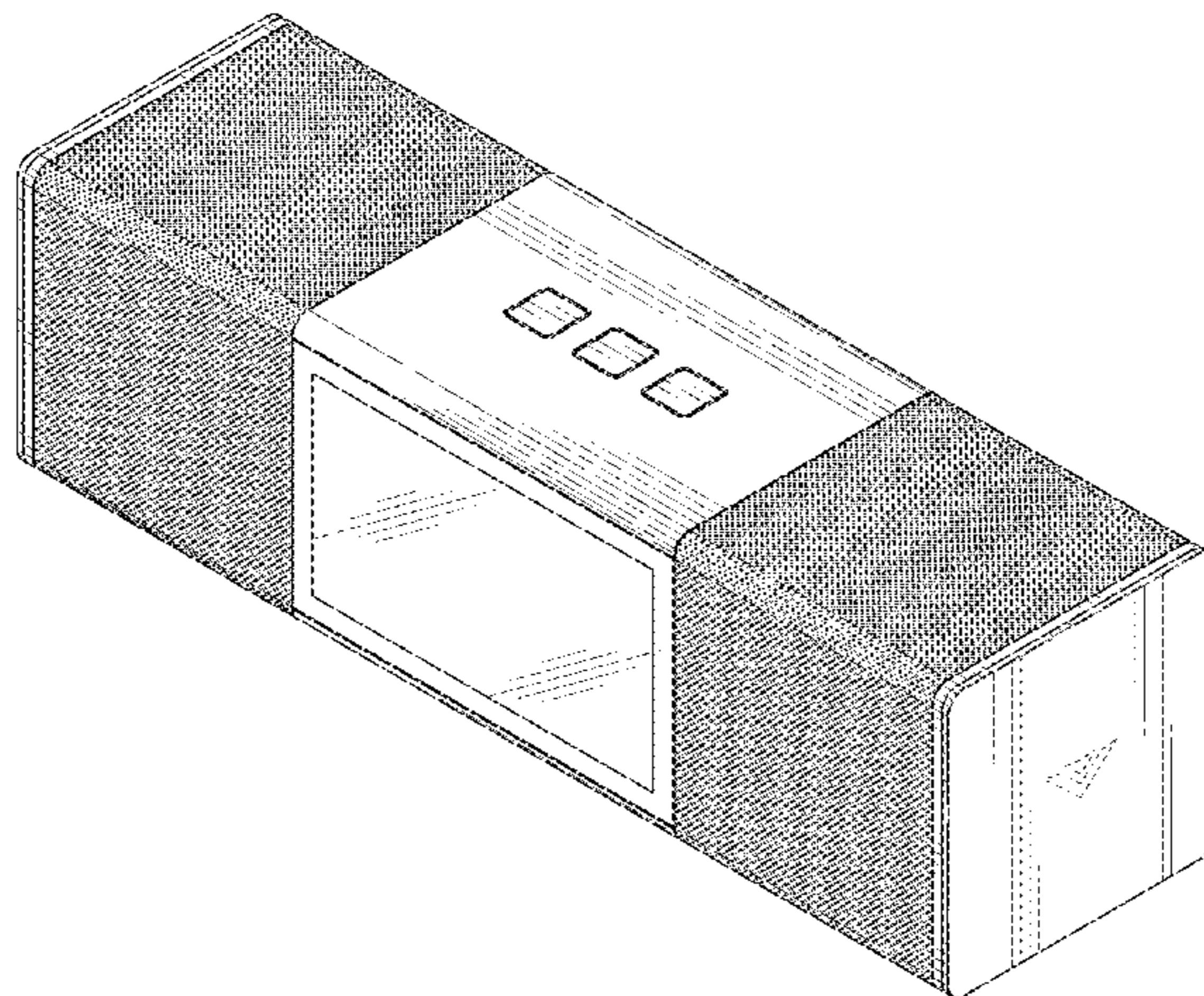

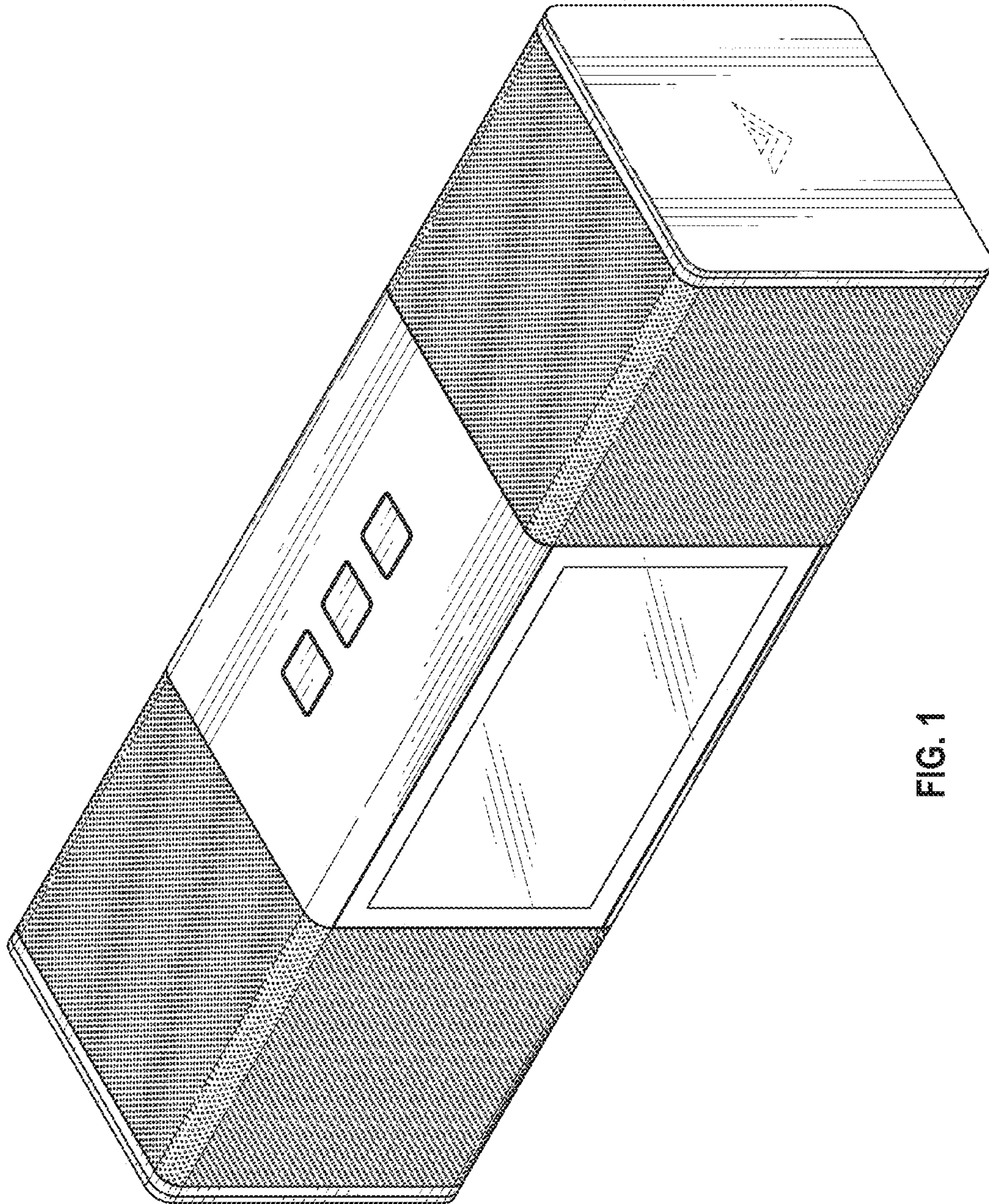

FIG. 1

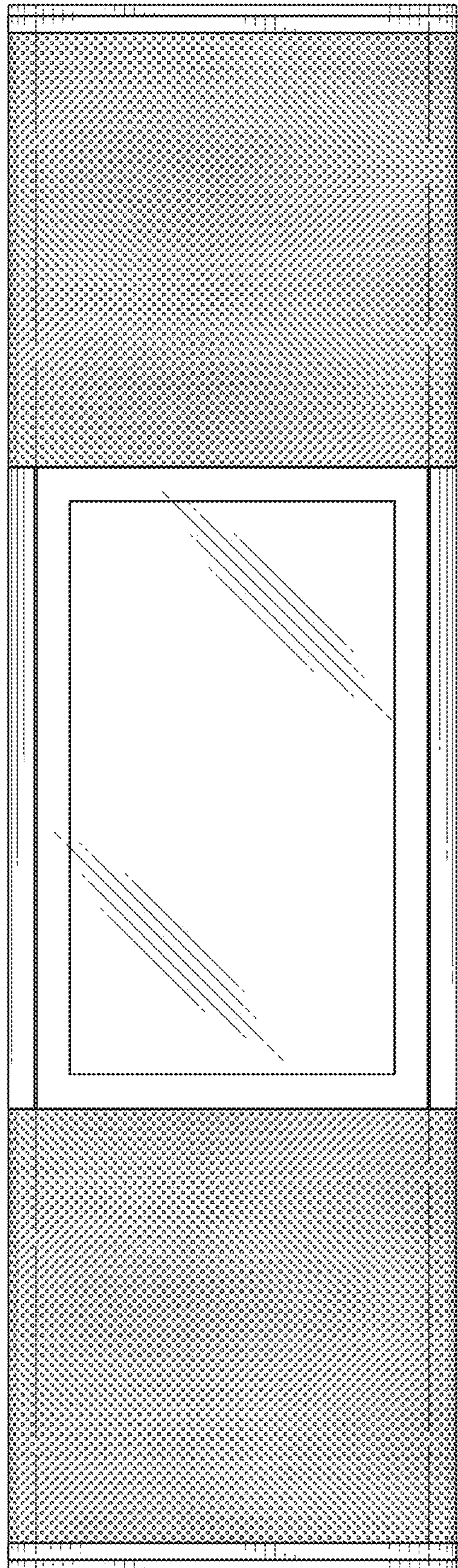

FIG. 2

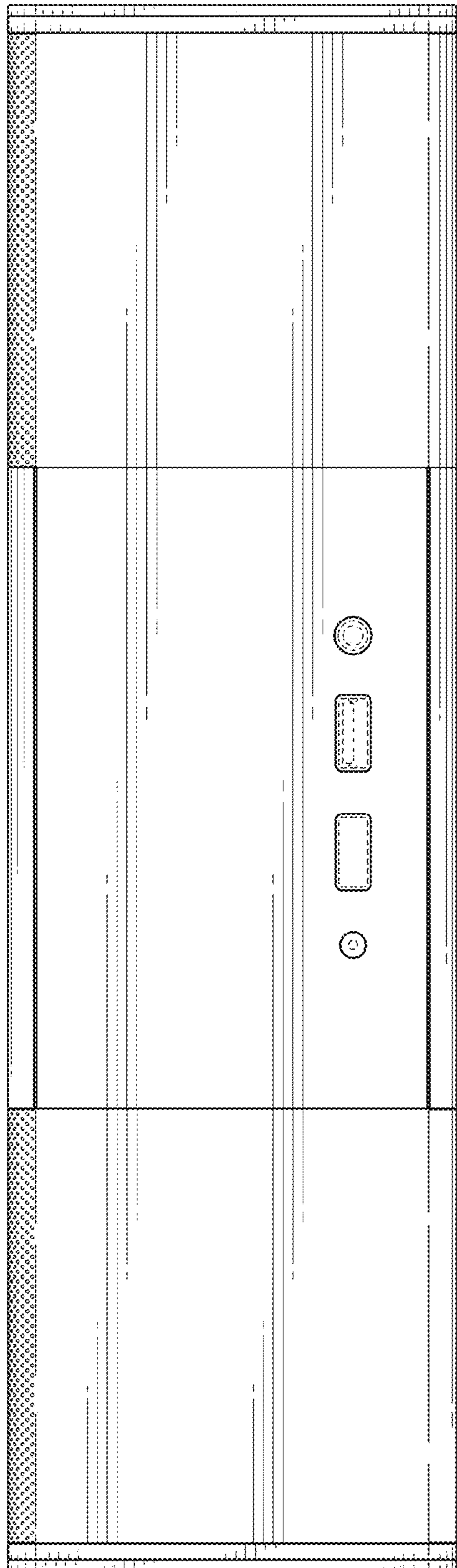

FIG. 3

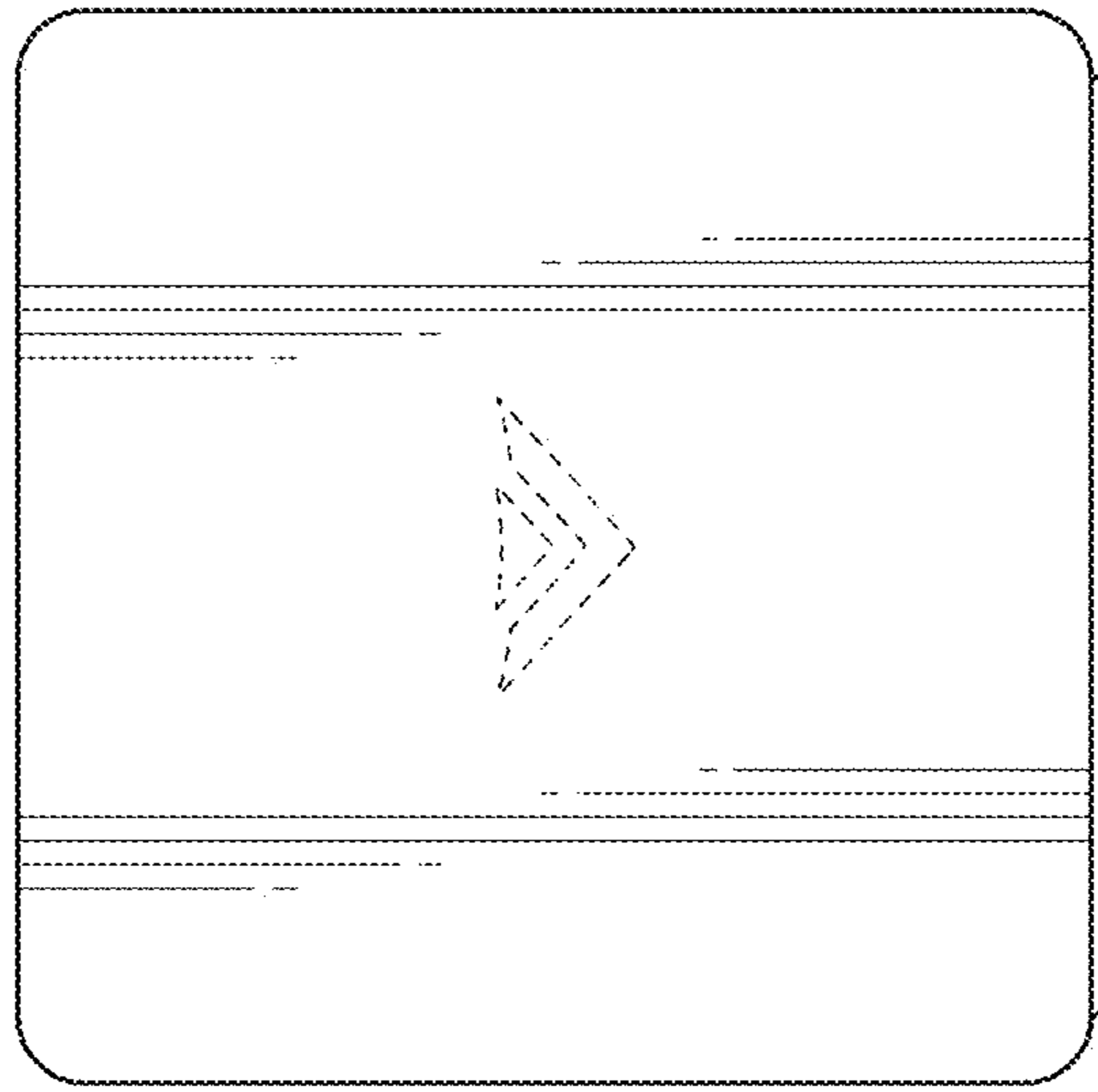

FIG. 4

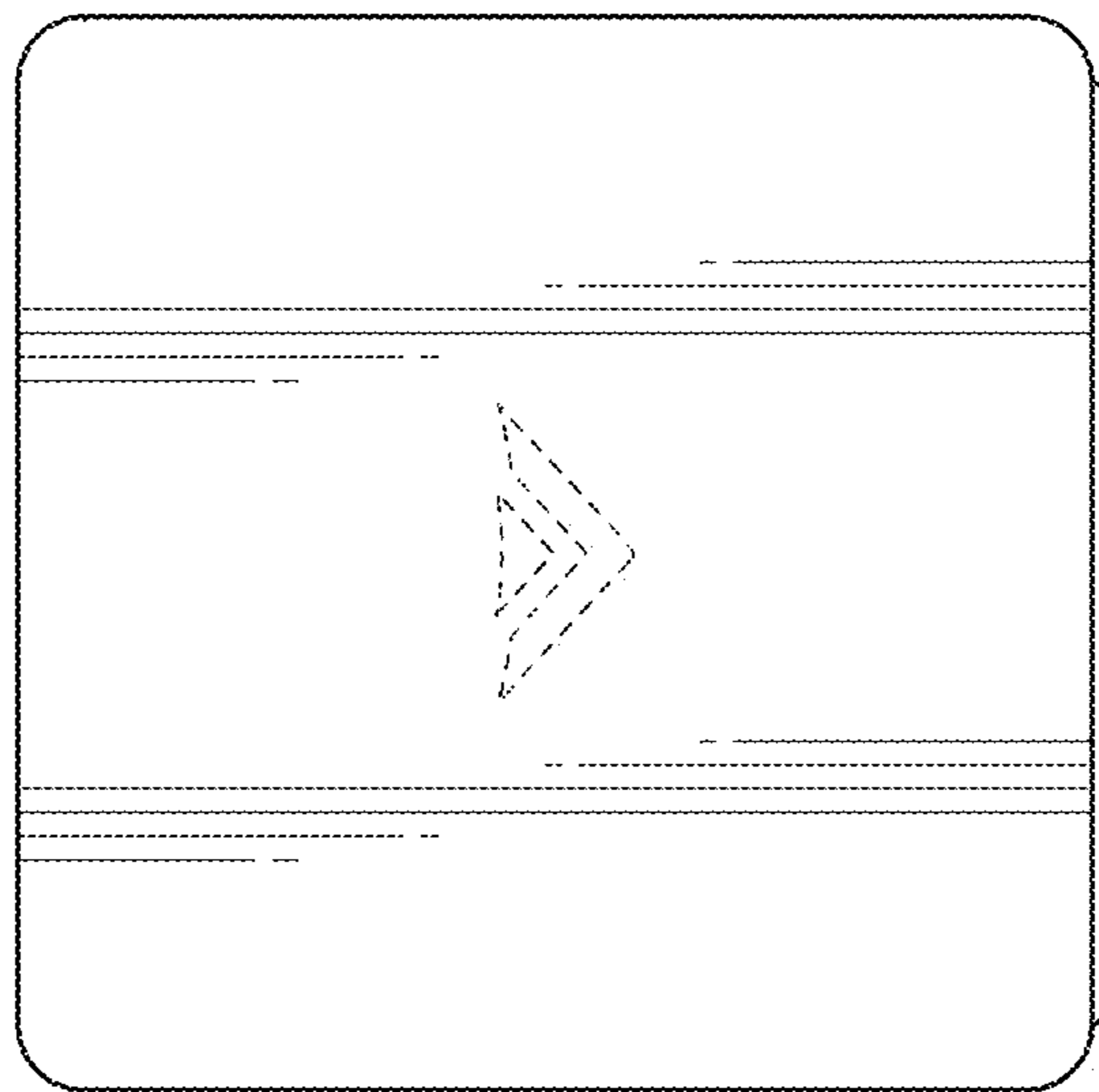

FIG. 5

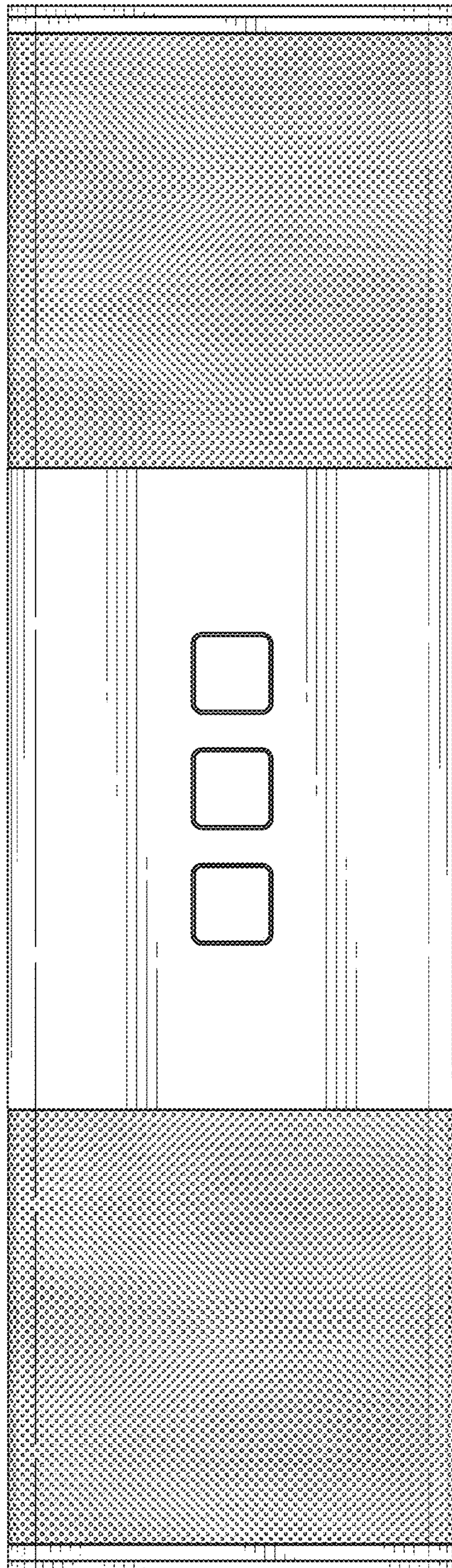

FIG. 6

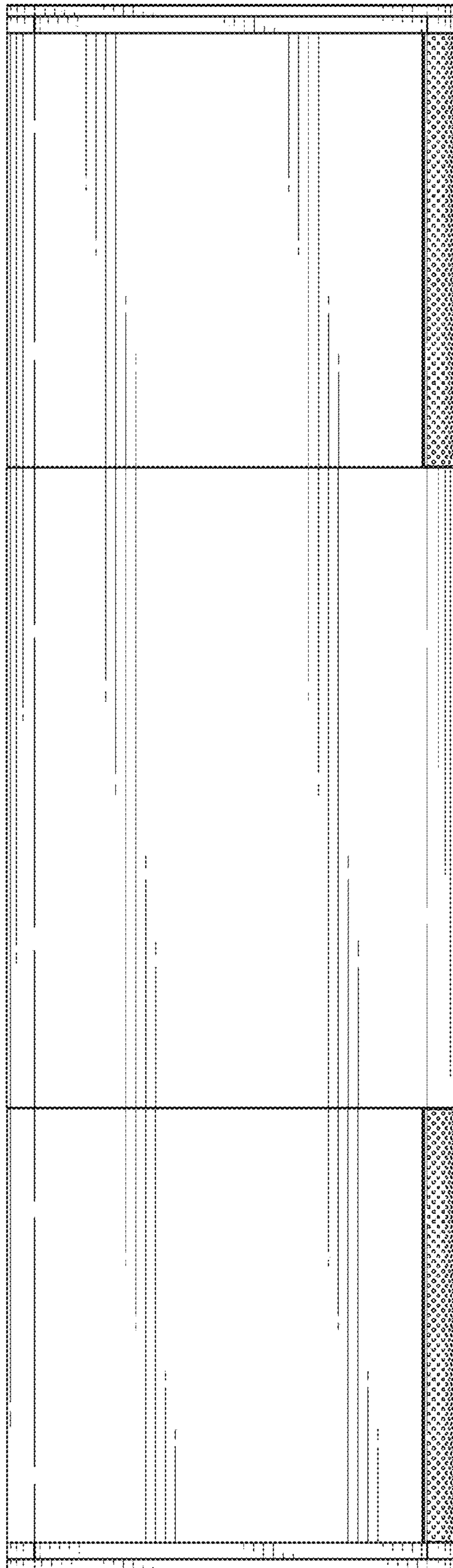

FIG. 7