



US00D748074S

(12) **United States Design Patent**  
**Schmiedbauer**

(10) **Patent No.:** **US D748,074 S**  
(45) **Date of Patent:** **\*\* Jan. 26, 2016**

(54) **LOUDSPEAKER**

- (71) Applicant: **Harman International Industries, Incorporated**, Northridge, CA (US)
- (72) Inventor: **Matthias Schmiedbauer**, Munich (DE)
- (73) Assignee: **Harman International Industries, Incorporated**, Northridge, CA (US)
- (\*\*) Term: **14 Years**
- (21) Appl. No.: **29/518,224**
- (22) Filed: **Feb. 20, 2015**

**Related U.S. Application Data**

- (62) Division of application No. 29/465,408, filed on Aug. 27, 2013, now Pat. No. Des. 726,684.
- (51) **LOC (10) Cl.** ..... **14-03**
- (52) **U.S. Cl.**  
USPC ..... **D14/210; D14/216**
- (58) **Field of Classification Search**  
USPC ..... D14/167, 168, 170-172, 188, 194-196, D14/204, 207, 209.1, 210-216, 219, 221, D14/222, 224, 496; 181/143, 144, 147, 148, 181/150, 153, 157, 198, 199; 381/300-303, 381/306, 332, 333, 336, 345, 361-364, 381/386-388; 369/6-12  
CPC .... B60R 11/0217; G06F 1/1688; G10K 9/22; G10K 11/004; H03F 1/327; H04M 1/03; H04M 1/035; H04N 5/642; H04N 21/4852; H04R 1/02; H04R 1/06; H04R 1/021; H04R 1/025; H04R 1/026; H04R 1/028; H04R 1/105; H04R 1/323; H04R 1/403; H04R 1/2803; H04R 1/2834; H04R 5/02; H04R 7/20; H04R 9/06; H04R 9/025; H04R 2201/021; H04R 2400/00; H04R 2400/07; H04R 2499/11; H04R 2499/13; H04R 2499/15; H04S 3/00; H04S 7/30  
See application file for complete search history.

(56) **References Cited**

**U.S. PATENT DOCUMENTS**

D555,636	S	*	11/2007	Chen	.....	D14/216
D571,359	S	*	6/2008	Chang	.....	D14/216
D611,450	S	*	3/2010	Miyazaki	.....	D14/209.1
D644,206	S	*	8/2011	Ponnert	.....	D14/216
D722,595	S	*	2/2015	Mackiewicz	.....	D14/216
D726,155	S	*	4/2015	Cheng	.....	D14/216
D726,684	S	*	4/2015	Schmiedbauer	.....	D14/210
D727,298	S	*	4/2015	Chang	.....	D14/216
D731,463	S	*	6/2015	Ho	.....	D14/214
D734,741	S	*	7/2015	Brunner	.....	D14/216
D737,246	S	*	8/2015	Billington	.....	D14/210
D737,248	S	*	8/2015	Billington	.....	D14/215
2014/0079267	A1	*	3/2014	Lyons	.....	H04R 1/026 381/334

\* cited by examiner

*Primary Examiner* — Keli L Hill

(74) *Attorney, Agent, or Firm* — Plumsea Law Goup, LLC

(57) **CLAIM**

The ornamental design for a loudspeaker, as shown and described.

**DESCRIPTION**

FIG. 1 is a perspective view of a loudspeaker showing my new design;  
 FIG. 2 is a front elevational view thereof;  
 FIG. 3 is a rear elevational view thereof;  
 FIG. 4 is a top plan view thereof;  
 FIG. 5 is a bottom plan view thereof;  
 FIG. 6 is an end elevational view of one end thereof; and,  
 FIG. 7 is an end elevational view of the opposite end thereof.  
 The broken line showings form no part of the claimed design.

**1 Claim, 7 Drawing Sheets**

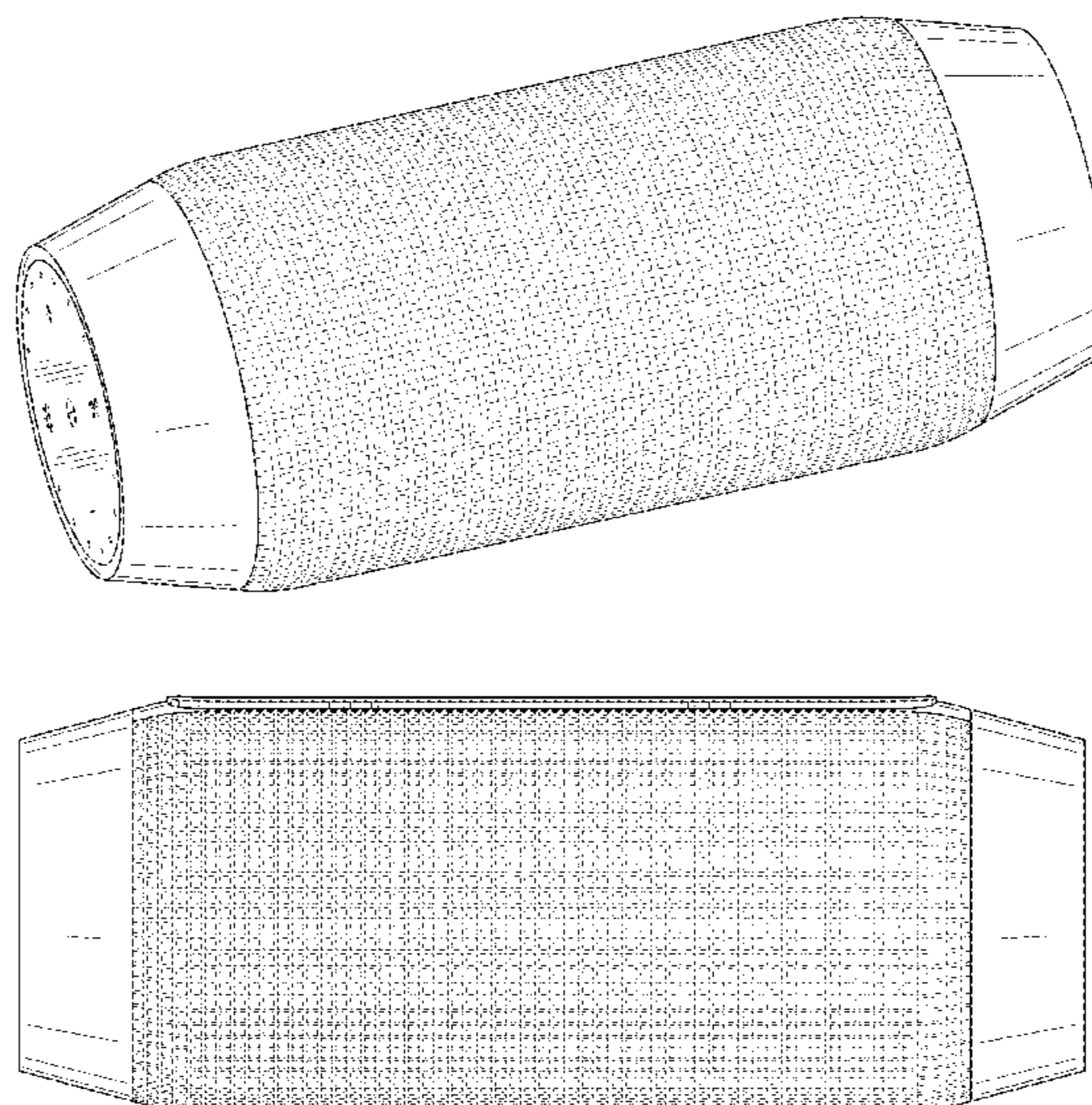

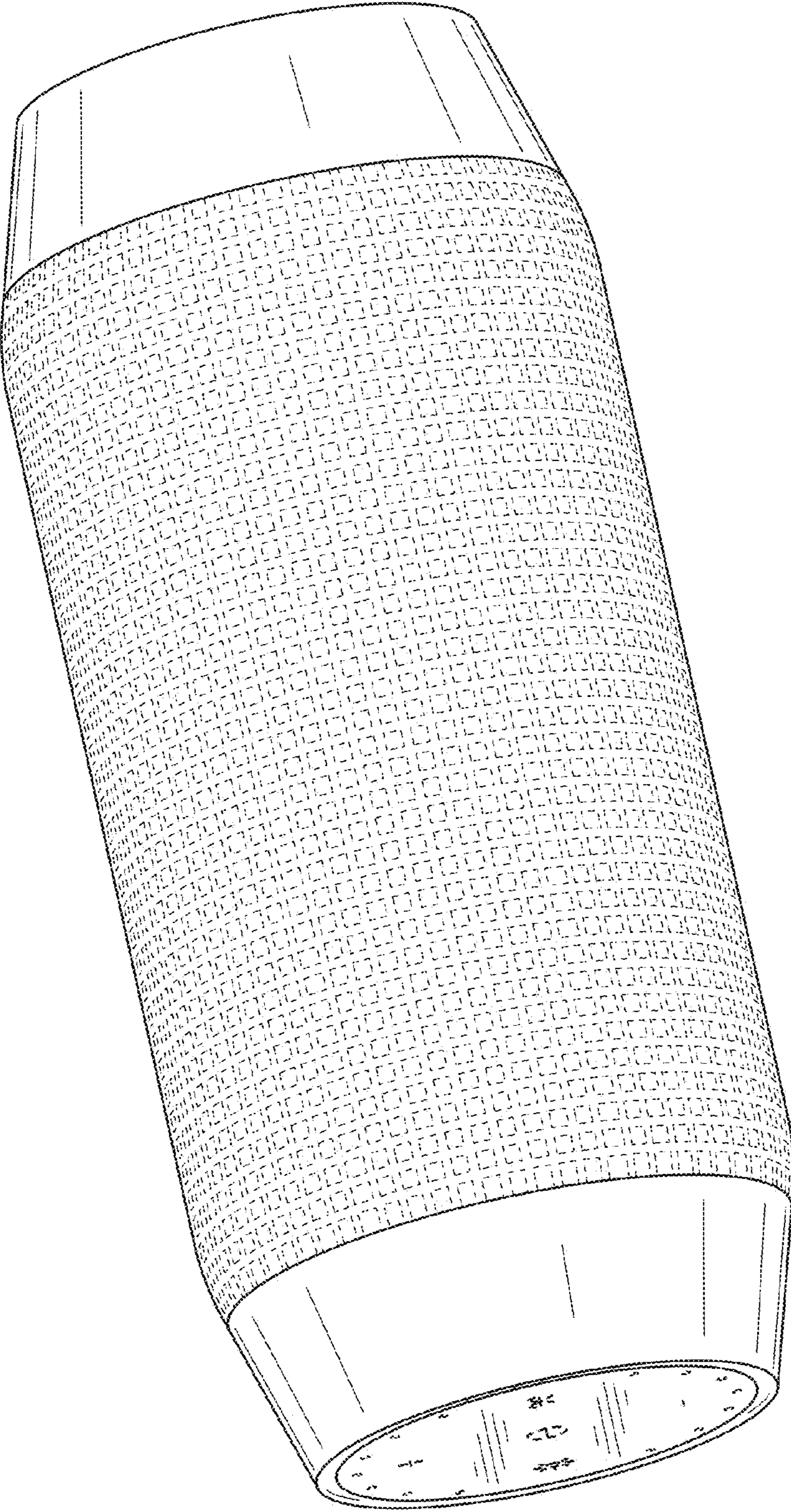

FIG. 1



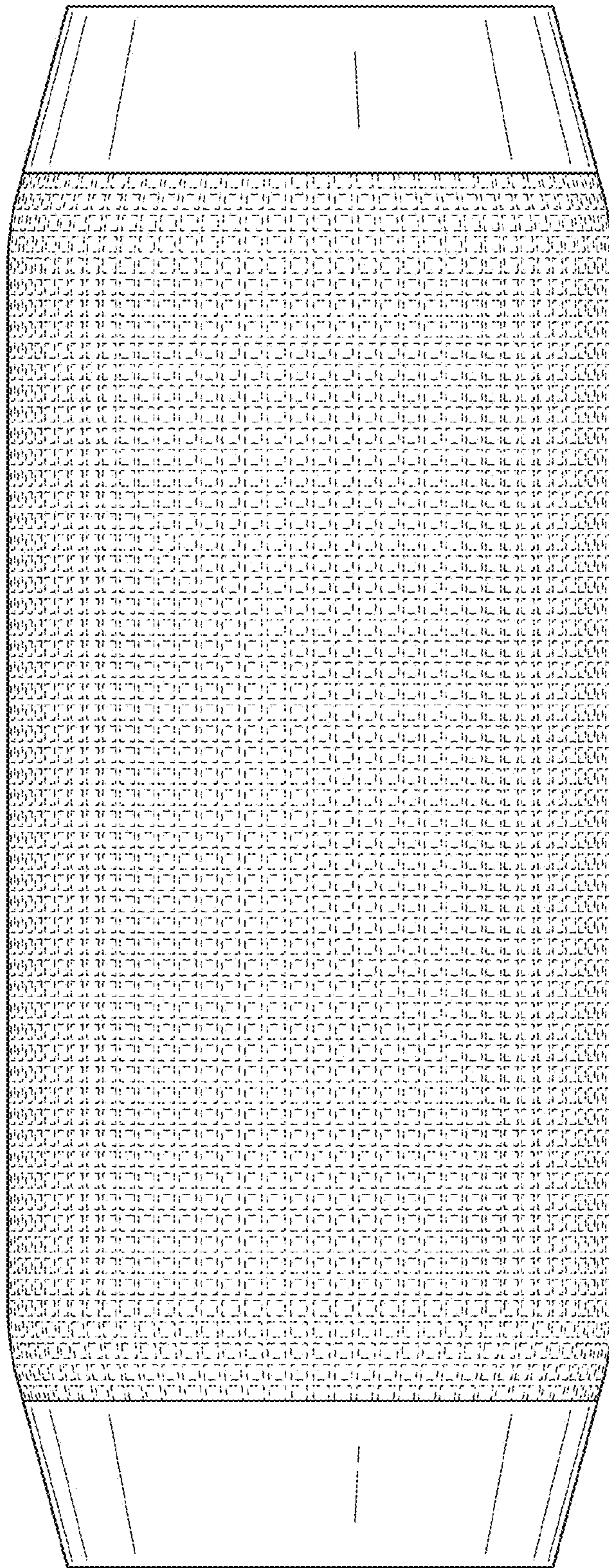

FIG. 2

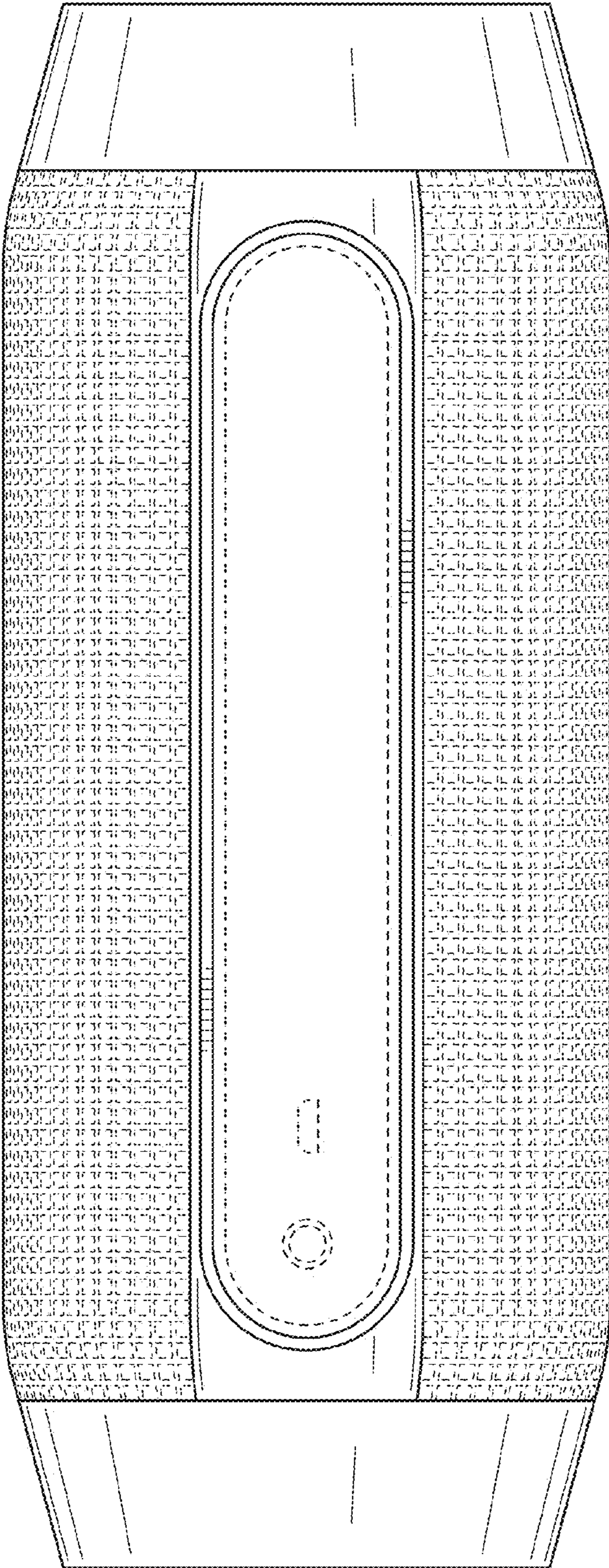

FIG. 3



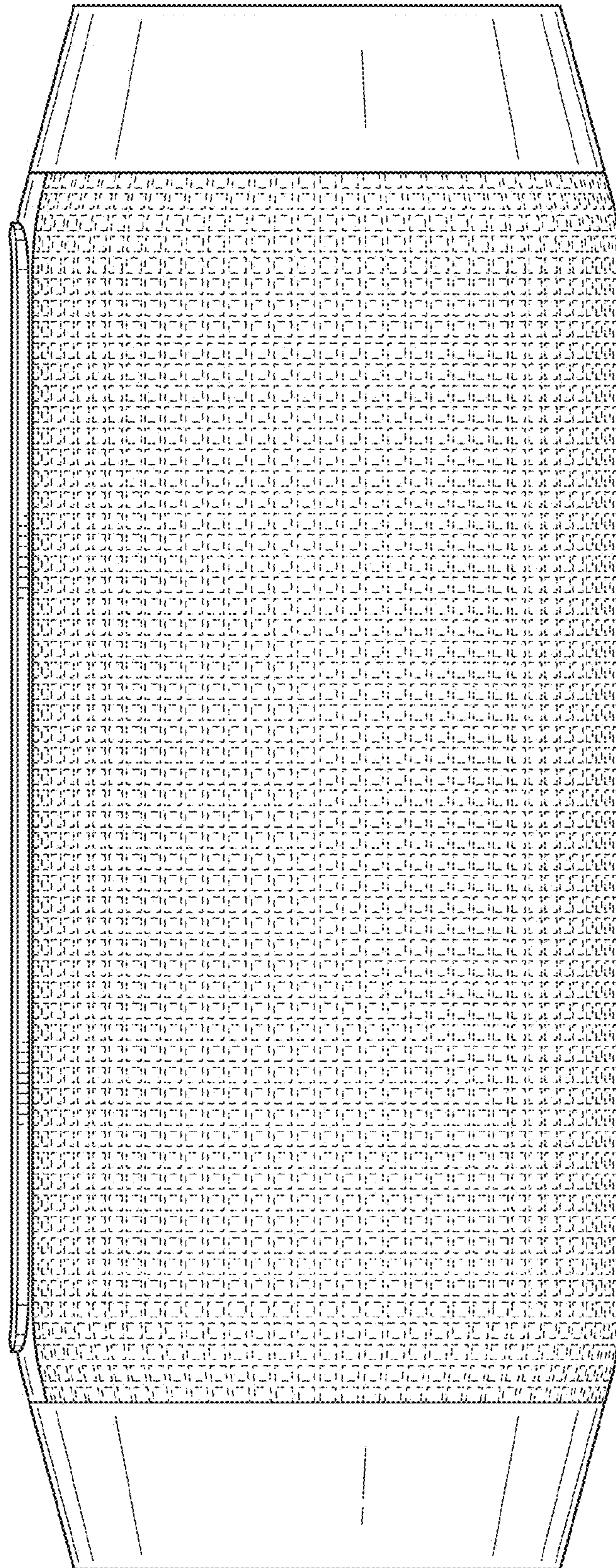

FIG. 4

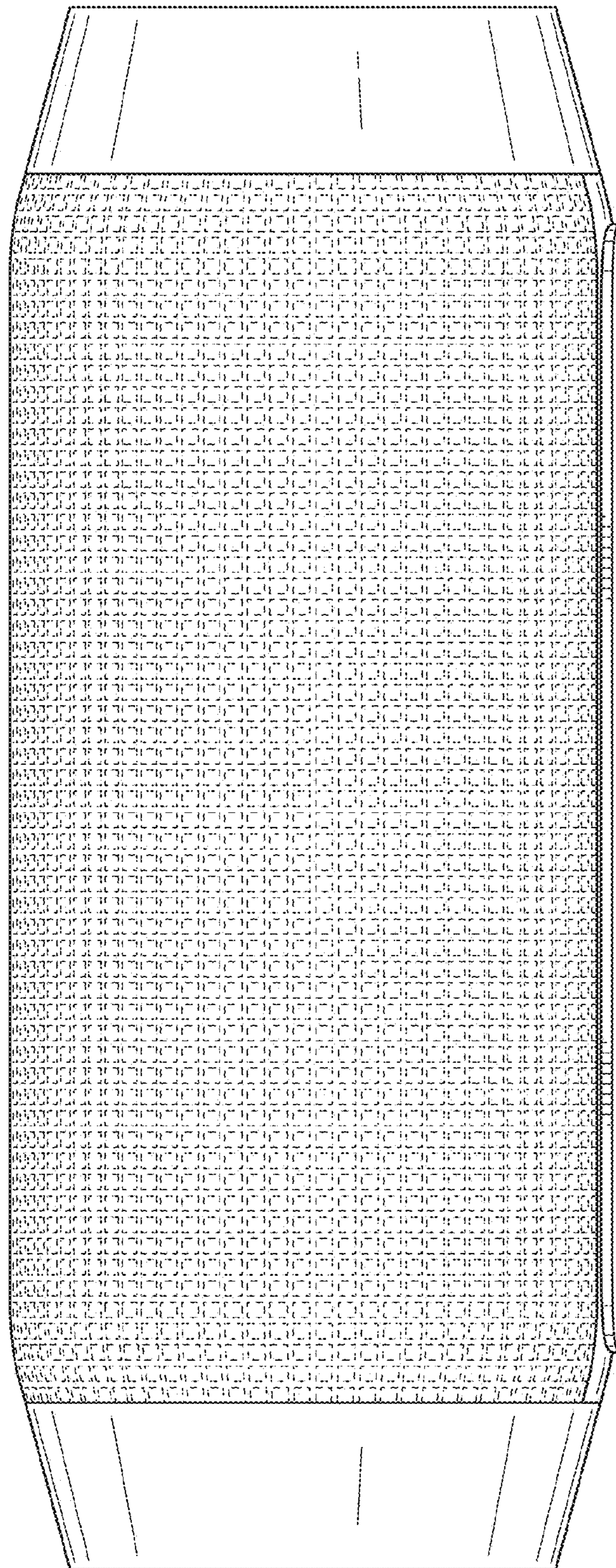

FIG. 5



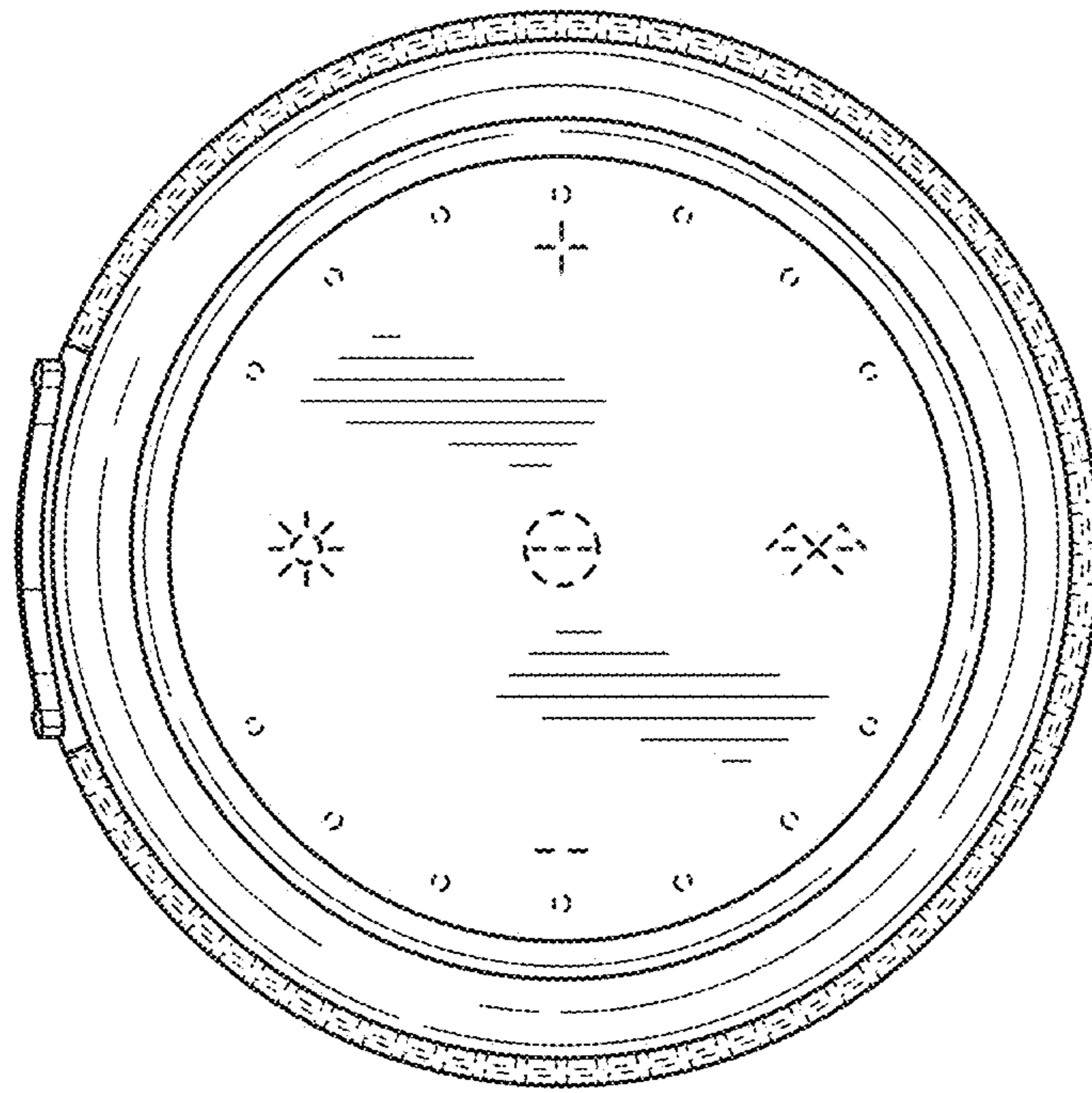
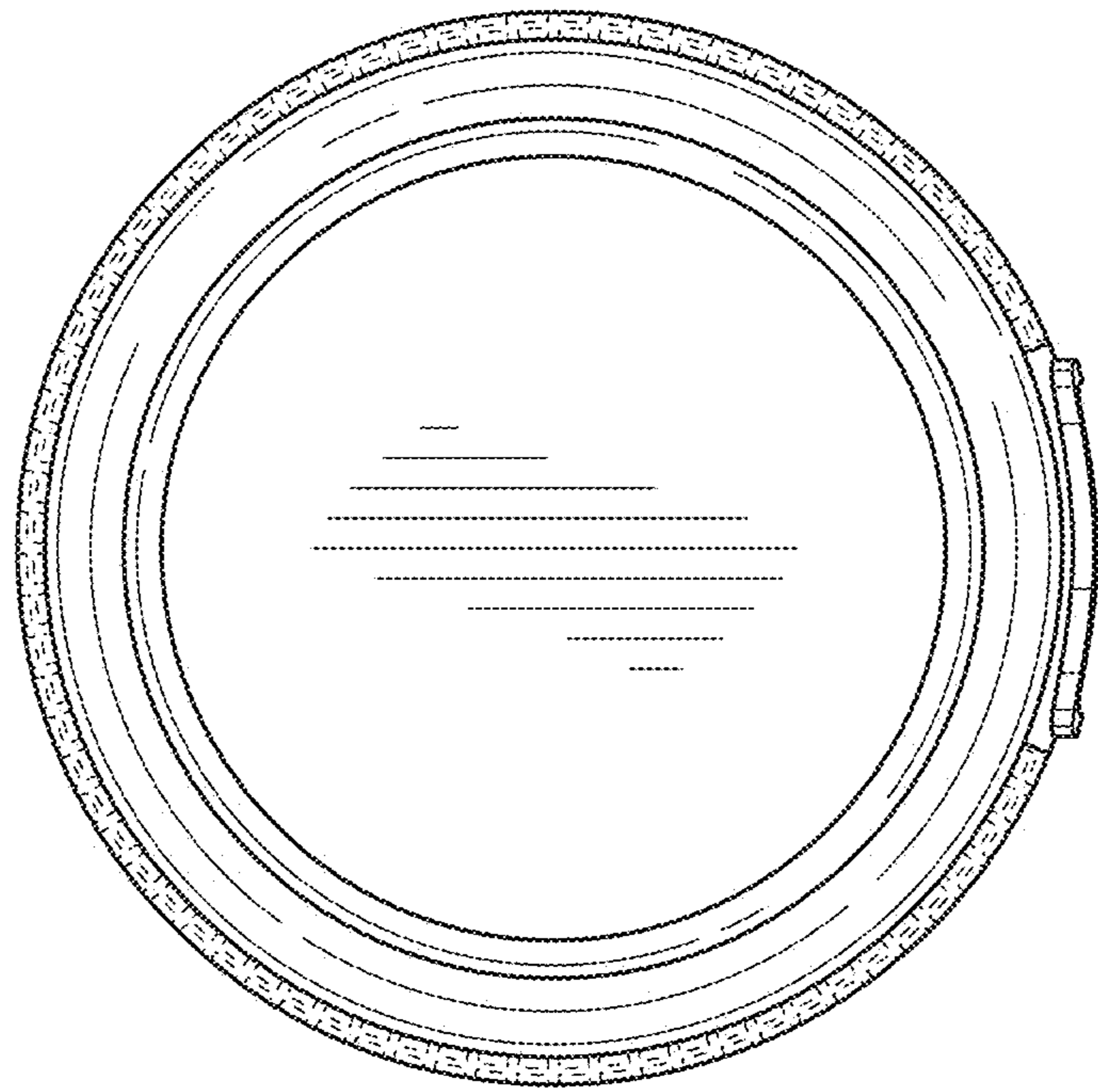

FIG. 6



**FIG. 7**