



US00D748011S

(12) **United States Design Patent**  
**Hoffman**

(10) **Patent No.:** **US D748,011 S**  
(45) **Date of Patent:** **\*\* Jan. 26, 2016**

(54) **REUSABLE APPARATUS FOR AFFIXING GIFT MATERIAL TO A PRESENTATION DEVICE**

(71) Applicant: **Donald Hoffman**, Oceanside, CA (US)

(72) Inventor: **Donald Hoffman**, Oceanside, CA (US)

(\*\*) Term: **14 Years**

(21) Appl. No.: **29/437,872**

(22) Filed: **Nov. 21, 2012**

**Related U.S. Application Data**

(63) Continuation of application No. 12/846,610, filed on Jul. 29, 2010, now abandoned.

(51) **LOC (10) Cl.** ..... **11-99**

(52) **U.S. Cl.**  
USPC ..... **D11/184**

(58) **Field of Classification Search**  
USPC ..... D6/404, 702; D11/117, 130, 143, 157,  
D11/164, 184; D13/183; D20/22, 23, 26;  
428/17, 19, 23, 24, 25  
See application file for complete search history.

(56) **References Cited**

**U.S. PATENT DOCUMENTS**

D28,734 S *	5/1898	Muller	.....	D26/101
2,012,085 A *	8/1935	Lorius	.....	428/360
D126,561 S *	4/1941	Tenney	.....	D6/404
D319,705 S *	9/1991	Tsai	.....	D26/127
D345,021 S *	3/1994	Storey et al.	.....	D26/27
D387,700 S *	12/1997	Shieh	.....	D11/143
D417,887 S *	12/1999	Coipel	.....	D19/6
D504,082 S *	4/2005	Weiser et al.	.....	D11/117
D509,315 S *	9/2005	Weiser et al.	.....	D26/101
D516,944 S *	3/2006	Weiser et al.	.....	D11/117
D525,903 S *	8/2006	Weiser et al.	.....	D11/117
7,326,452 B1 *	2/2008	Vargas et al.	.....	428/23

D600,224 S *	9/2009	Lanktree	.....	D13/183
D675,126 S *	1/2013	Hauskins	.....	D11/117
2010/0159162 A1 *	6/2010	Hao et al.	.....	428/24
2011/0114525 A1 *	5/2011	Hoffman	.....	206/457
2012/0121826 A1 *	5/2012	Marlow	.....	428/24

\* cited by examiner

*Primary Examiner* — Eric Goodman

*Assistant Examiner* — Amy Wierenga

(74) *Attorney, Agent, or Firm* — K&L Gates LLP; Louis C. Cullman; Brent A. Johnson

(57) **CLAIM**

The ornamental design for a reusable apparatus for affixing gift material to a presentation device, as shown and described.

**DESCRIPTION**

FIG. 1 is a top-down 45 degree tilted perspective view of a reusable apparatus for affixing gift material to a presentation device, showing my new design;

FIG. 2 is a back-side view of a reusable apparatus for affixing gift material to a presentation device, showing my new design;

FIG. 3 is a front-side view of a reusable apparatus for affixing gift material to a presentation device, showing my new design;

FIG. 4 is a bottom-up 45 degree tilted perspective view of a reusable apparatus for affixing gift material to a presentation device, showing my new design;

FIG. 5 is a bottom view of a reusable apparatus for affixing gift material to a presentation device, showing my new design; and,

FIG. 6 is a top-down view of a reusable apparatus for affixing gift material to a presentation device, showing my new design.

The dashed lines shown in the drawings are for the purpose of depicting shading only and form no part of the claimed design.

**1 Claim, 2 Drawing Sheets**

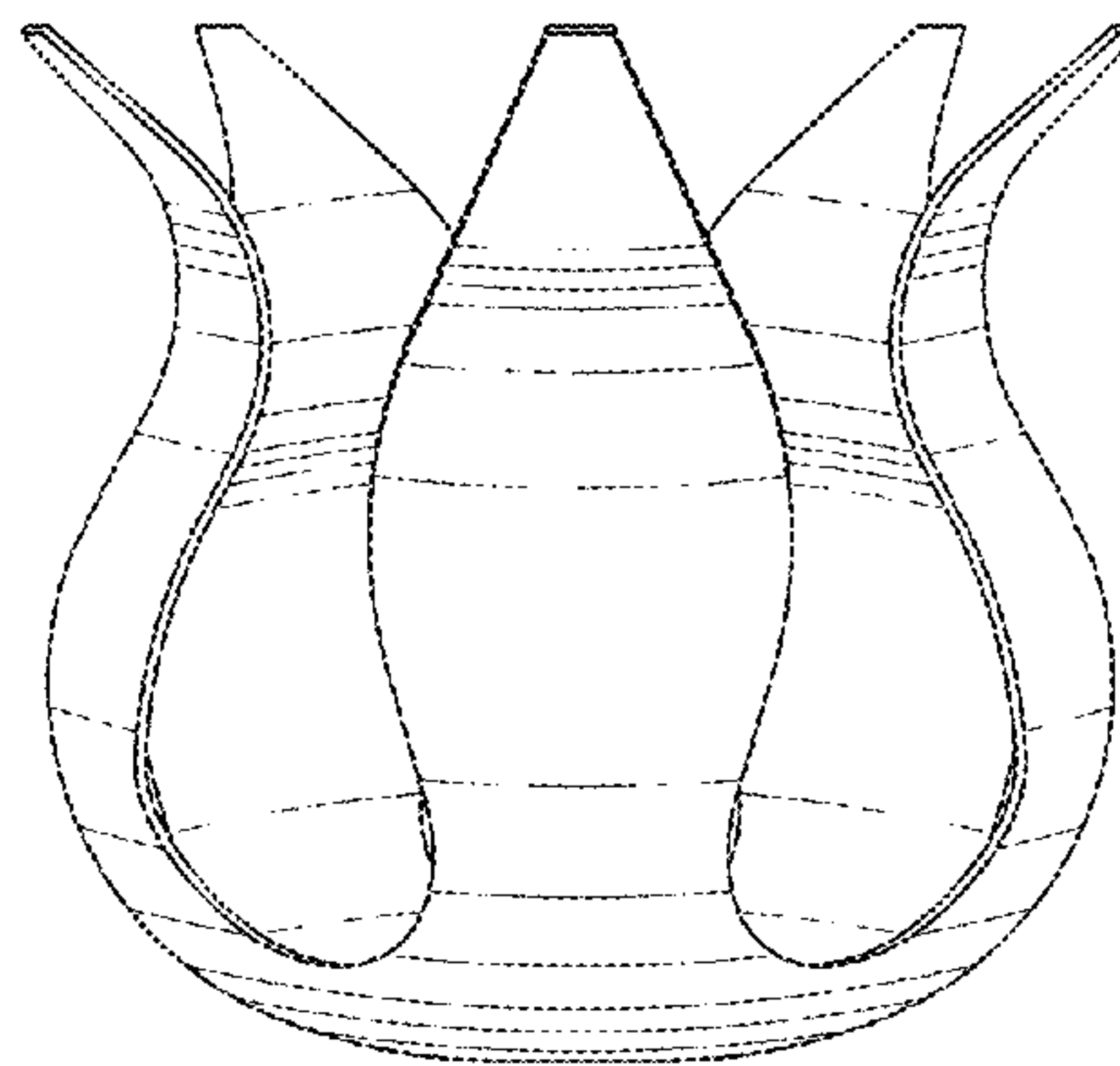
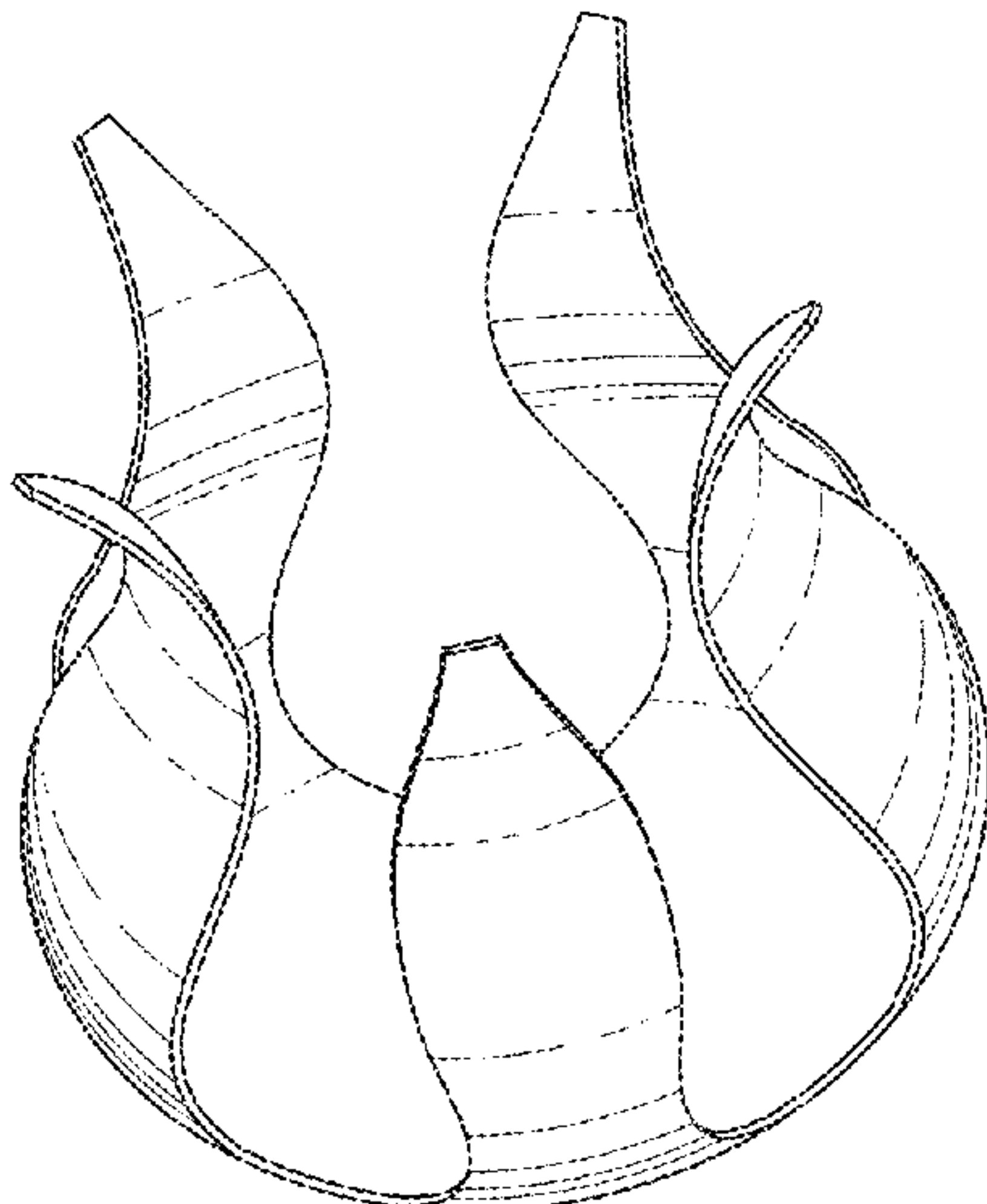

FIG. 1

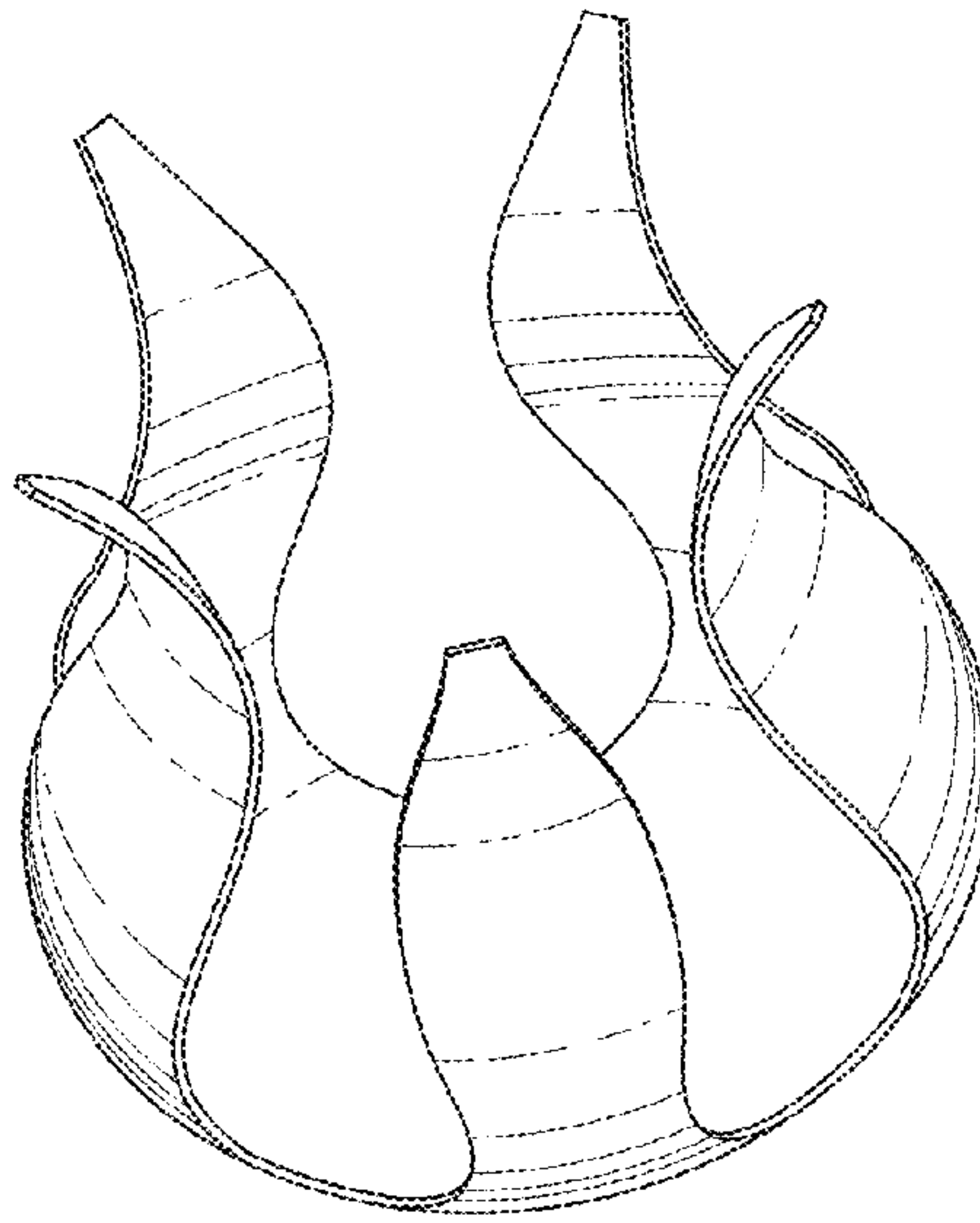

FIG. 2

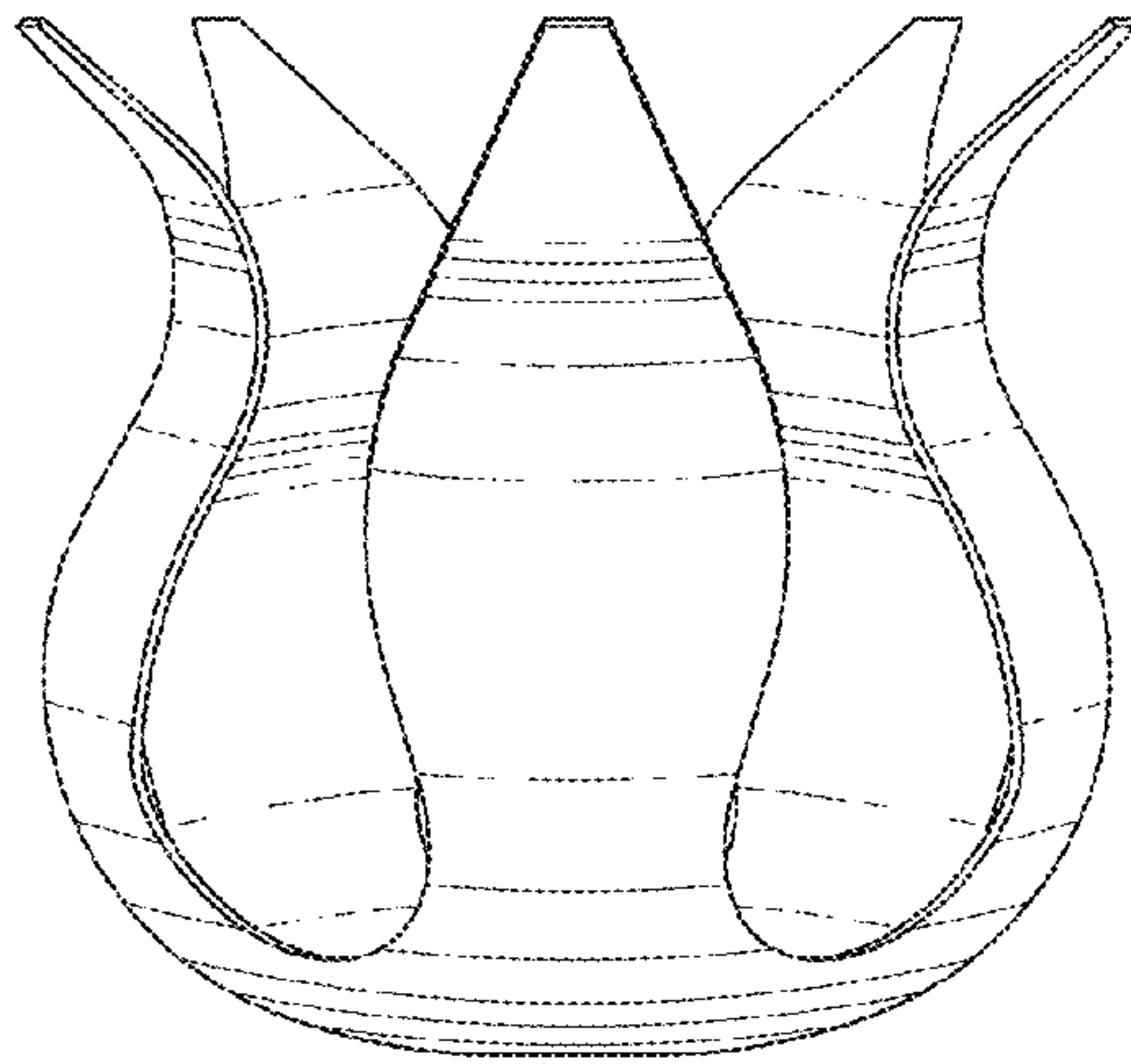
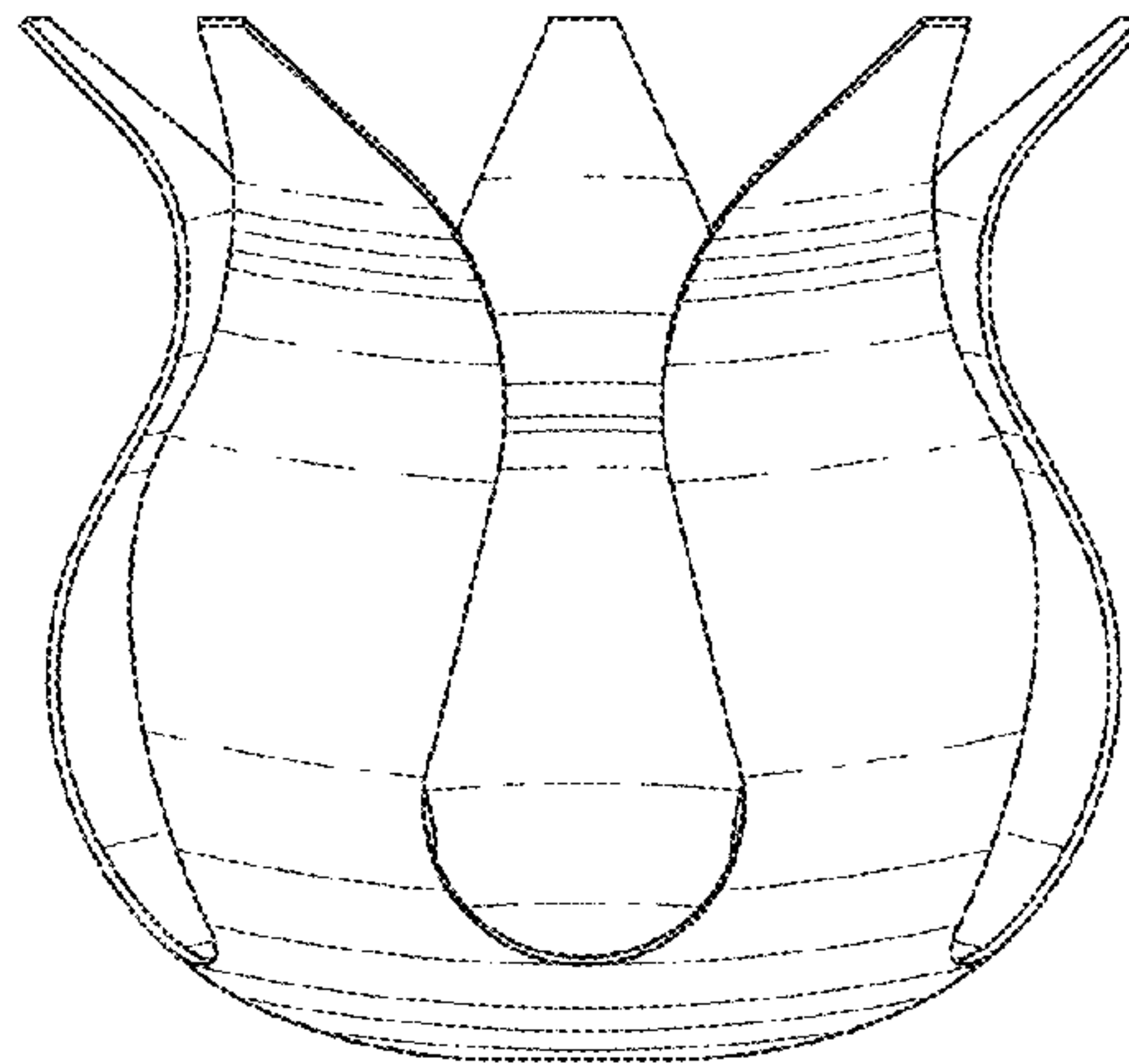

FIG. 3



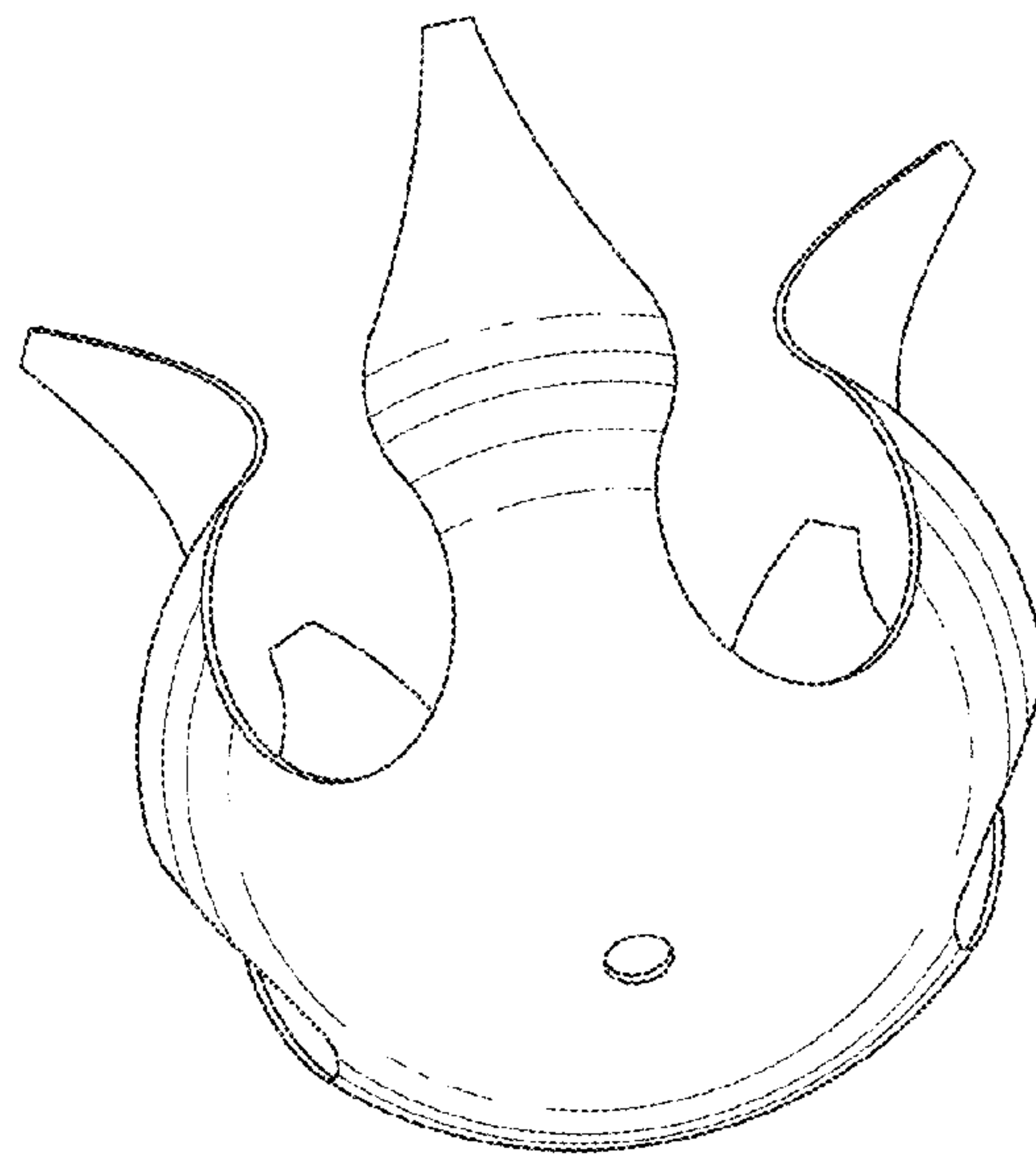

FIG. 4

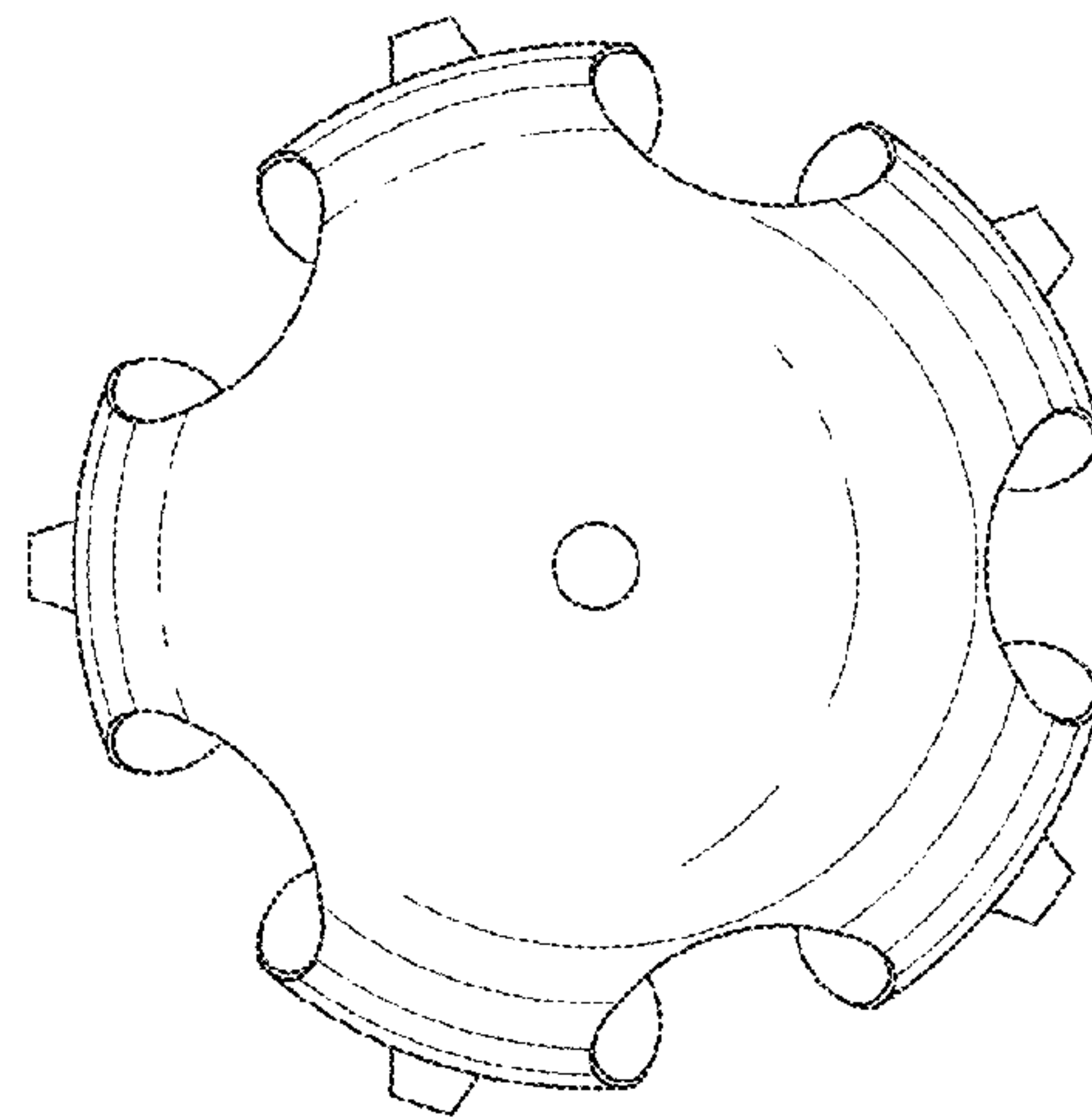

FIG. 5

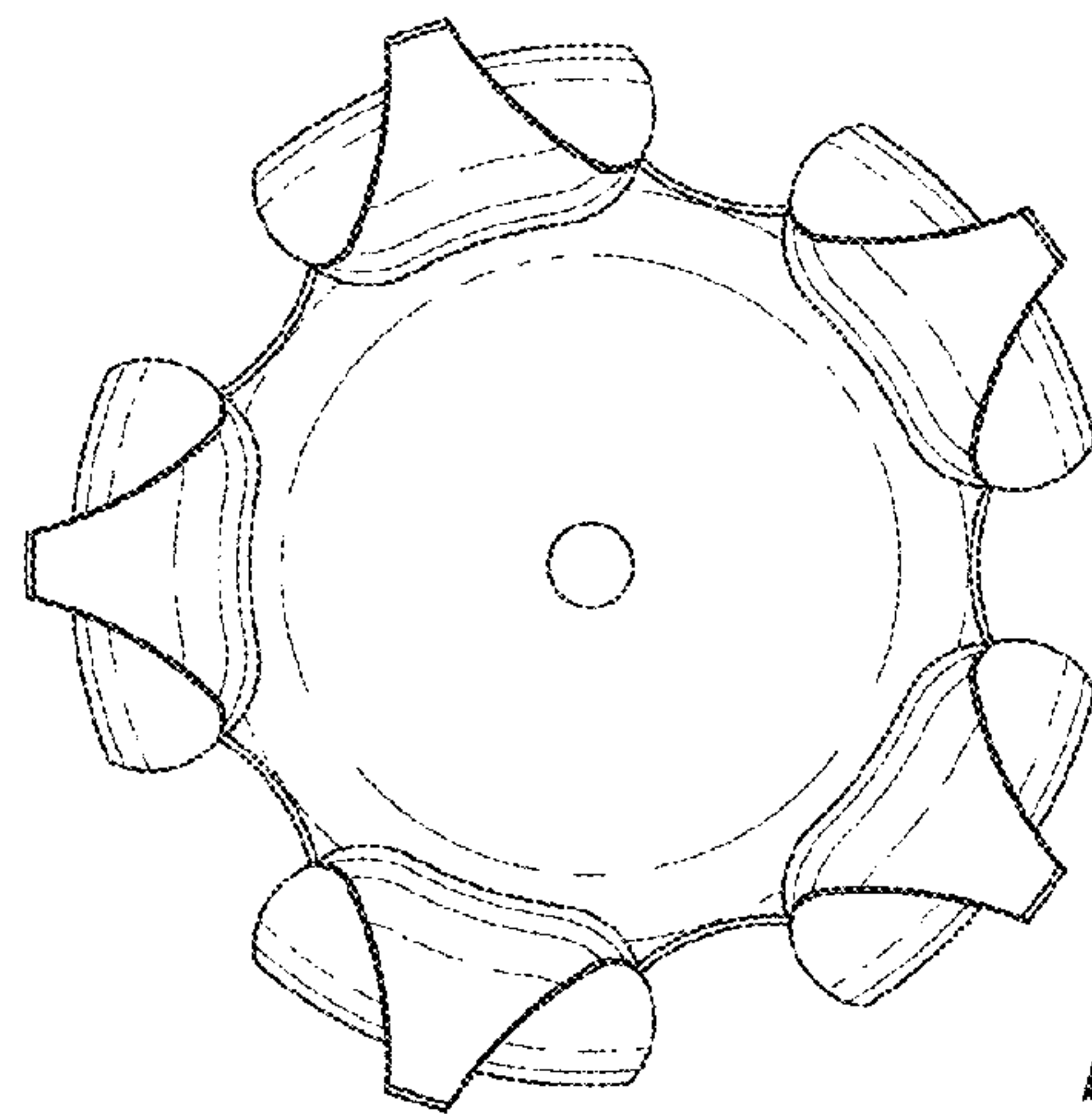

FIG. 6