



US00D747958S

(12) **United States Design Patent**  
**Hyakutake et al.**

(10) **Patent No.:** **US D747,958 S**  
(45) **Date of Patent:** **\*\* Jan. 26, 2016**

- (54) **JOINT FOR CONNECTION**
- (71) Applicant: **ADAMANT KOGYO CO., LTD.**,  
Tokyo (JP)
- (72) Inventors: **Yasuhiro Hyakutake**, Tokyo (JP);  
**Shinichi Takeda**, Tokyo (JP); **Yusuke**  
**Akiyama**, Tokyo (JP)
- (73) Assignee: **ADAMANT KOGYO CO., LTD.**,  
Tokyo (JP)
- (\*\*) Term: **14 Years**
- (21) Appl. No.: **29/421,934**
- (22) Filed: **Oct. 23, 2012**
- (30) **Foreign Application Priority Data**  
May 22, 2012 (JP) ..... 2012-011976
- (51) **LOC (10) Cl.** ..... **08-08**
- (52) **U.S. Cl.**  
USPC ..... **D8/382**
- (58) **Field of Classification Search**  
USPC ..... D8/30, 382, 330, 331, 339, 341, 343,  
D8/344, 499; D10/80, 103, 121; D11/206,  
D11/220, 87, 86, 93, 184; D21/578, 597,  
D21/584, 658  
CPC .. F16C 11/06; F16C 11/0604; F16C 11/0619;  
F16C 11/0623; F16B 2012/403; A63H 33/10;  
A63H 33/101; Y10T 403/32631  
See application file for complete search history.

4,044,725	A *	8/1977	Miller	.....	119/865
4,338,755	A *	7/1982	Chichester, Jr.	.....	411/80.2
D392,555	S *	3/1998	Glickman et al.	.....	D8/382
D393,417	S *	4/1998	Glickman et al.	.....	D8/382
D423,919	S *	5/2000	Galinski	.....	D8/382
7,695,170	B1 *	4/2010	Baldwin et al.	.....	362/371
D659,523	S *	5/2012	Nielsen	.....	D8/382
8,277,095	B2 *	10/2012	Juang et al.	.....	362/421
2006/0030234	A1 *	2/2006	Stiber et al.	.....	446/124
2009/0196682	A1 *	8/2009	Kuhlman	.....	403/133

**FOREIGN PATENT DOCUMENTS**

EP	1925831	A2 *	5/2008	.....	F16C 11/0604
FR	2521445	A1 *	8/1983	.....	A63H 33/101
WO	WO 2007008172	A1 *	1/2007	.....	F16C 11/06

\* cited by examiner

*Primary Examiner* — Sheryl Lane  
*Assistant Examiner* — Ieisha Price

(74) *Attorney, Agent, or Firm* — Manabu Kanesaka

(57) **CLAIM**

The ornamental design for a joint for connection, as shown and described.

**DESCRIPTION**

FIG. 1 is a front view of a joint for connection showing our new design, which is identical to the rear view,  
 FIG. 2 is a right side view thereof;  
 FIG. 3 is a left side view thereof;  
 FIG. 4 is a top plan view thereof,  
 FIG. 5 is a bottom view thereof  
 FIG. 6 is a sectional view taken along line 6-6 in FIG. 4,  
 FIG. 7 is a perspective view thereof; and,  
 FIG. 8 is a perspective view thereof, showing the joint for connection in its environment.  
 The broken line showing in FIG. 8 represents the environment of the claimed design and forms no part thereof.

**1 Claim, 8 Drawing Sheets**

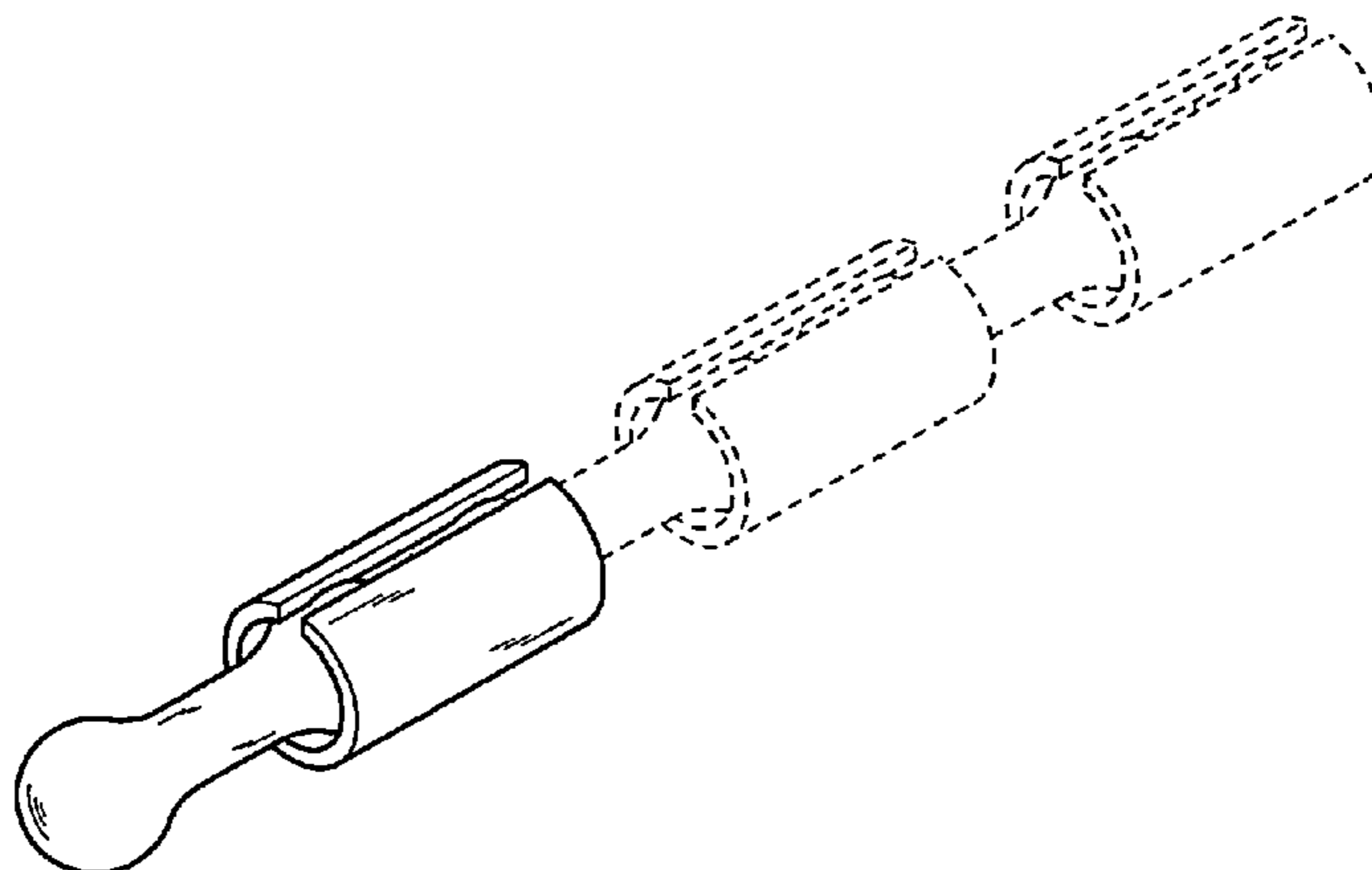

Fig. 1

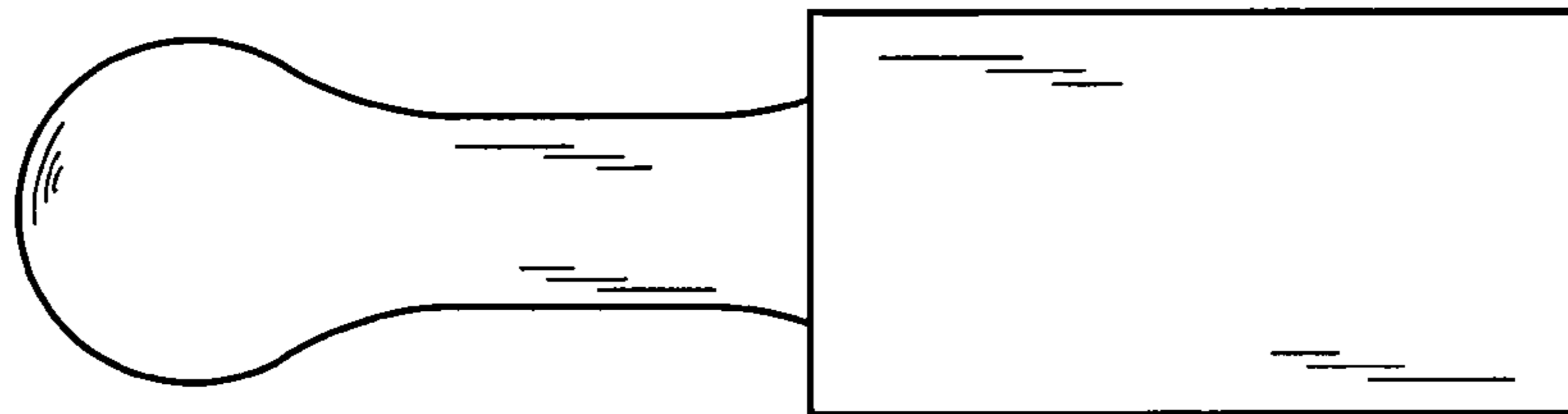

Fig. 2

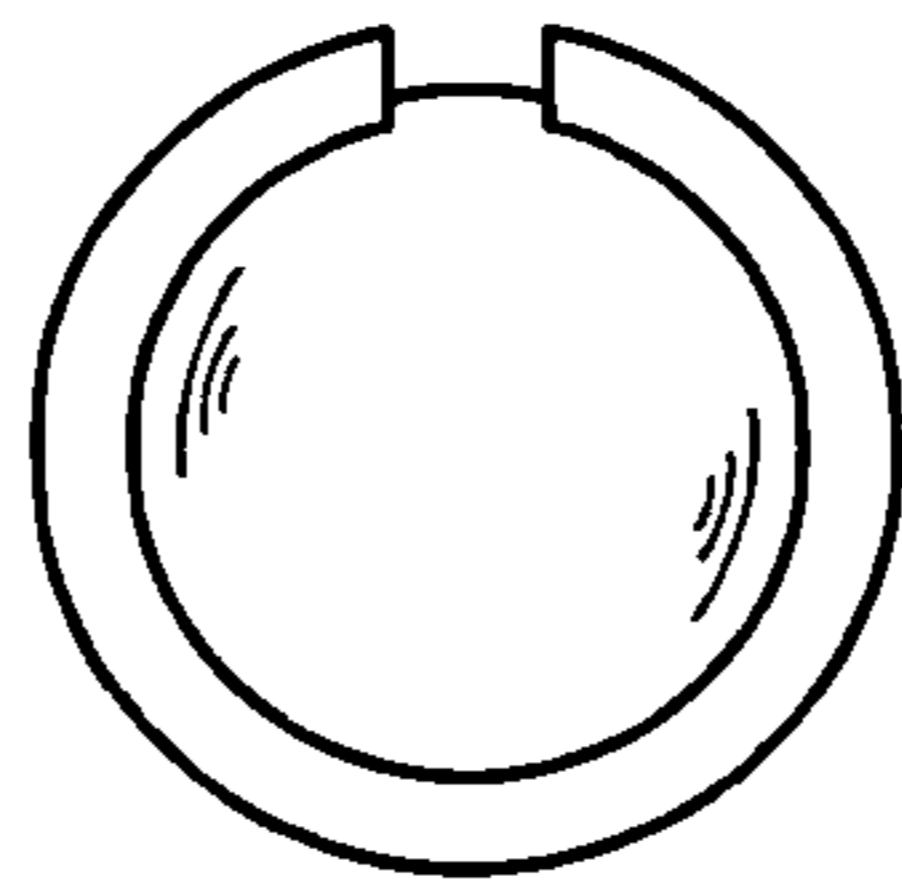

Fig. 3

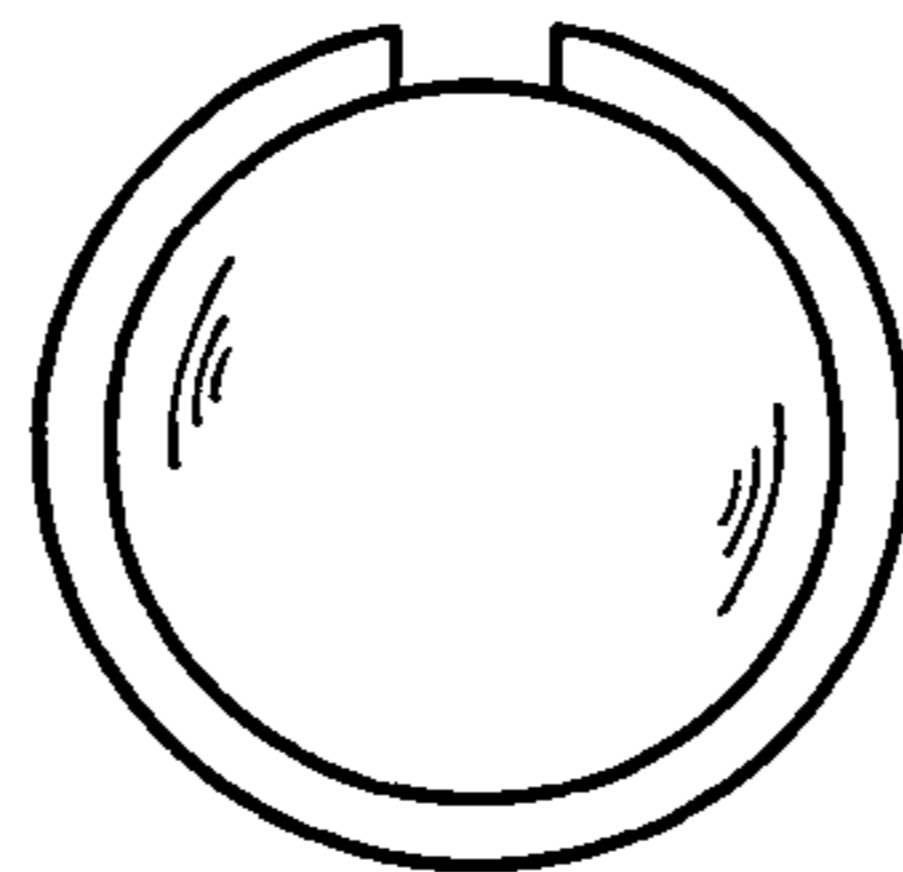

Fig. 4

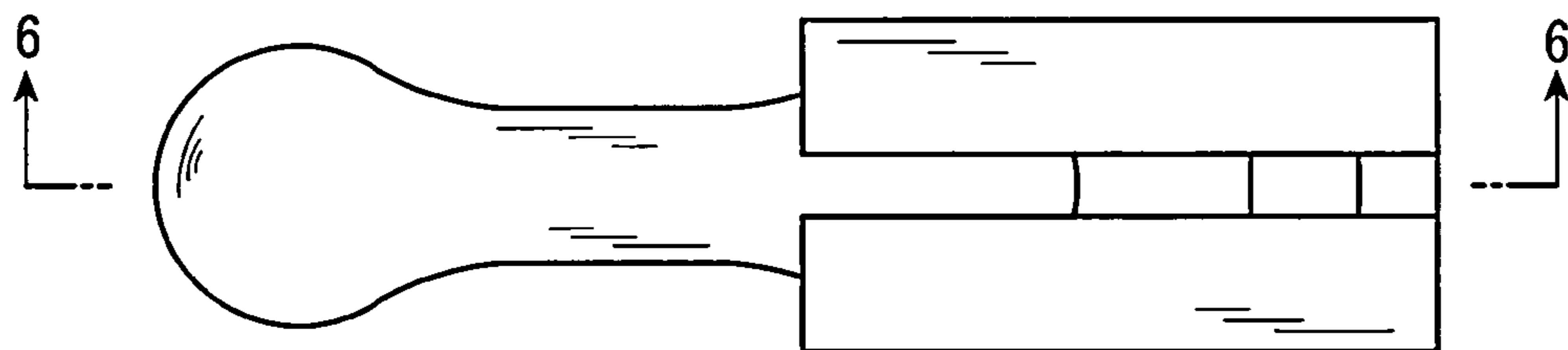

Fig. 5

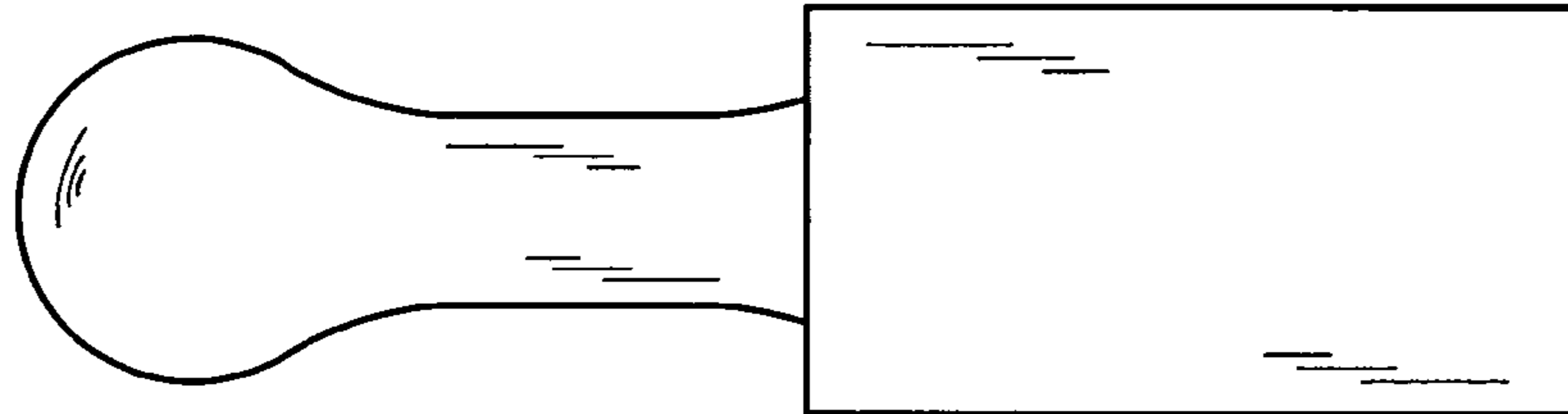

Fig. 6

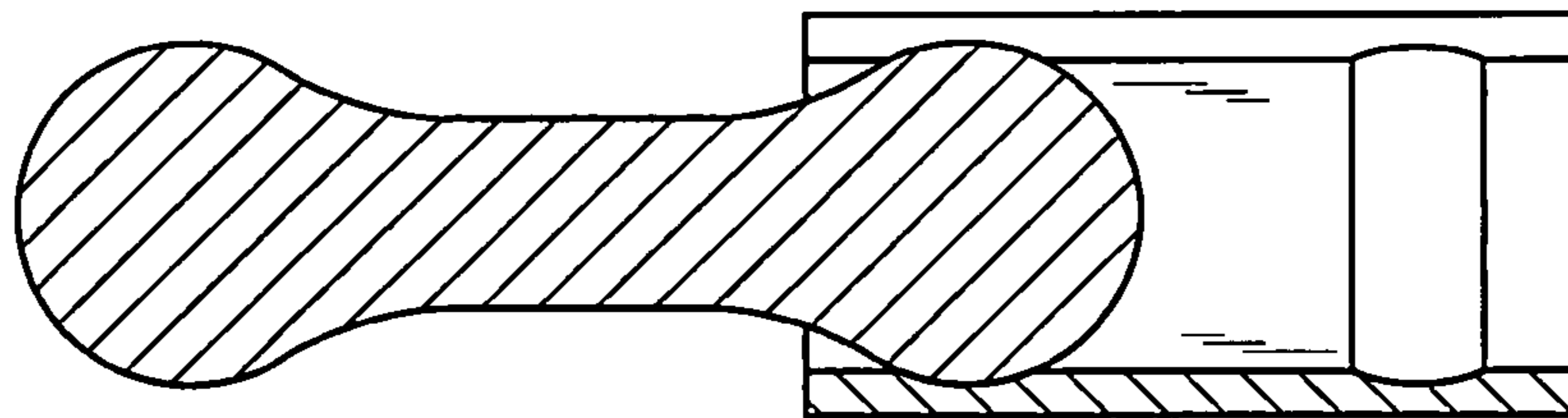

Fig. 7

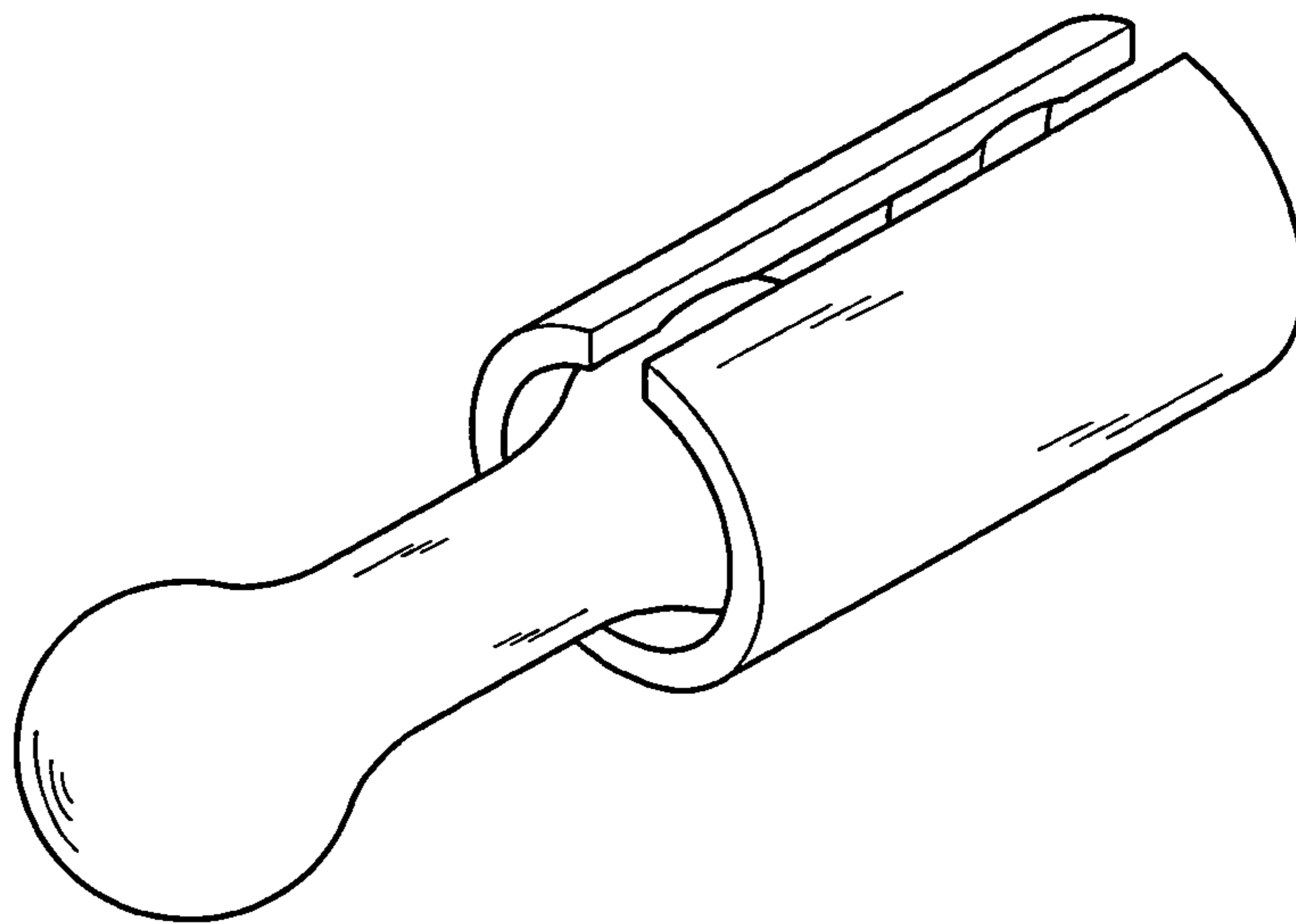



Fig. 8

