



US00D747877S

(12) **United States Design Patent**
Goodman et al.

(10) **Patent No.:** **US D747,877 S**
(45) **Date of Patent:** **** Jan. 26, 2016**

- (54) **STYLING CADDY**
- (71) Applicant: **Spectrum Diversified Designs, Inc.**,
Streetsboro, OH (US)
- (72) Inventors: **Sheldon H. Goodman**, Solon, OH (US);
Phaysouk Xayoiphonh, Akron, OH
(US)
- (73) Assignee: **Spectrum Diversified Designs, LLC**,
Streetsboro, OH (US)

D583,563	S	*	12/2008	Snider	D3/306
D630,033	S	*	1/2011	Snider	D6/513
D632,908	S	*	2/2011	Tincher	D6/513
D650,175	S	*	12/2011	Lee	D3/306
D650,209	S	*	12/2011	Snider	D6/513
D661,929	S	*	6/2012	Purcell et al.	D6/525
D675,850	S	*	2/2013	Tawil	D6/705.6
D685,188	S	*	7/2013	Etherington et al.	D3/306
D692,666	S	*	11/2013	Goodman et al.	D3/304
D703,381	S	*	4/2014	Petruccelli	D28/73
D705,565	S	*	5/2014	Schraufnagel et al.	D6/513
D720,538	S	*	1/2015	Goodman et al.	D3/304

* cited by examiner

(**) Term: **14 Years**

Primary Examiner — Susan Bennett Hattan

(21) Appl. No.: **29/492,371**

Assistant Examiner — Charles Hanson

(22) Filed: **May 30, 2014**

(74) *Attorney, Agent, or Firm* — Benesch Friedlander
Coplan & Aronoff LLP

(51) **LOC (10) Cl.** **03-03**

(52) **U.S. Cl.**
USPC **D3/315**

(57) **CLAIM**

What is claimed is the ornamental design for a styling caddy,
as shown and described.

(58) **Field of Classification Search**
USPC D3/315–317, 205, 206; D6/525, 566,
D6/705.6; D28/17, 61
CPC B65D 7/20
See application file for complete search history.

DESCRIPTION

FIG. 1 is a perspective view of a styling caddy showing a new design;
FIG. 2 is a top view of the styling caddy of FIG. 1;
FIG. 3 is a front view of the styling caddy of FIG. 1;
FIG. 4 is a side view of the styling caddy of FIG. 1;
FIG. 5 is a rear view of the styling caddy of FIG. 1; and,
FIG. 6 is a bottom view of the styling caddy of FIG. 1.
The components of the display shown in broken lines illustrate portions of the styling caddy which form no part of the claimed design.

(56) **References Cited**

U.S. PATENT DOCUMENTS

1,684,995	A	*	9/1928	Kennard	220/491
6,039,422	A	*	3/2000	Butters et al.	312/334.1
D464,516	S	*	10/2002	Snell	D6/566
6,494,340	B1	*	12/2002	Joo	220/485
D473,085	S	*	4/2003	Walker	D6/525
D508,167	S	*	8/2005	Anderson et al.	D6/566
D546,101	S	*	7/2007	Knight	D6/705.6

1 Claim, 2 Drawing Sheets

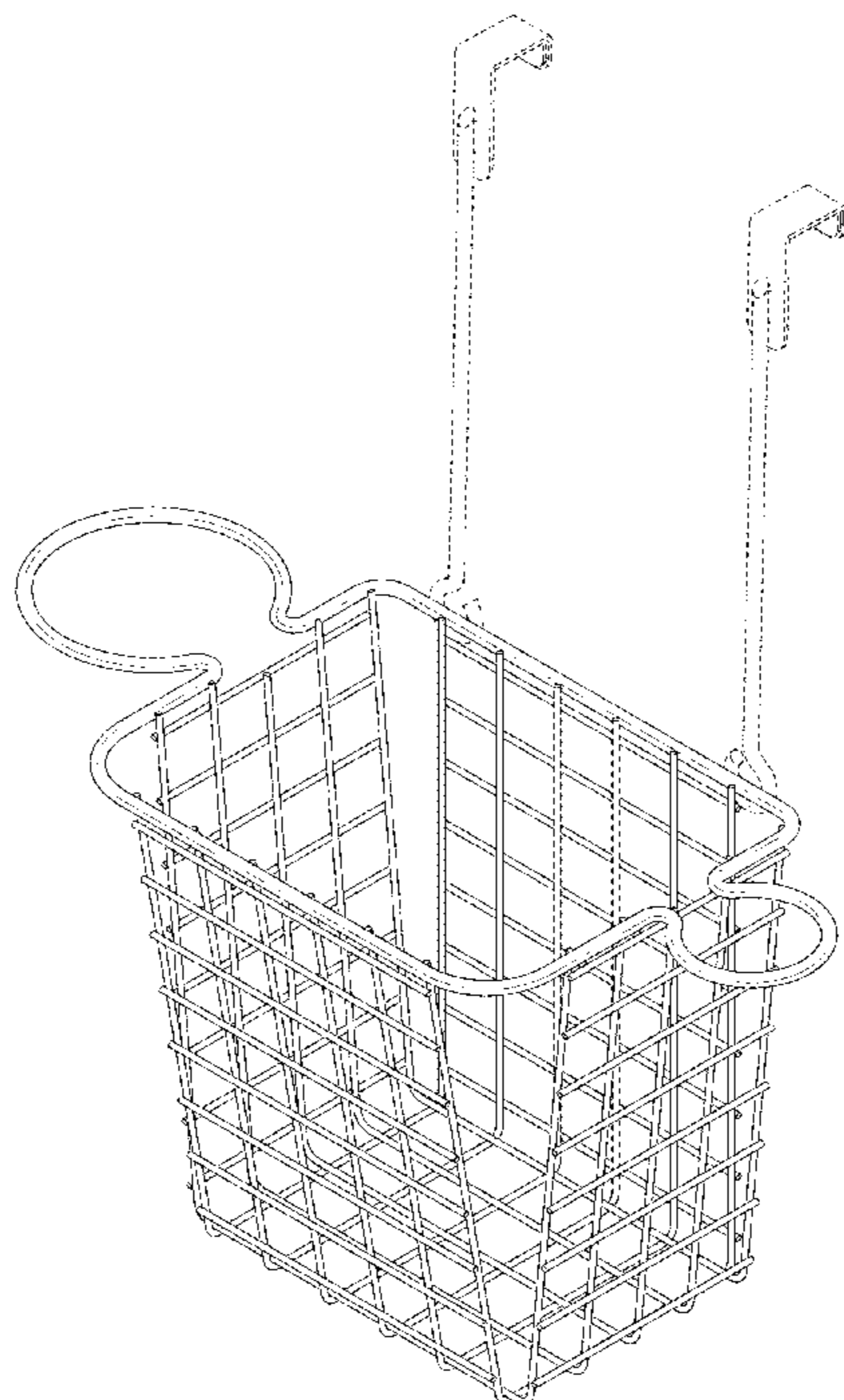

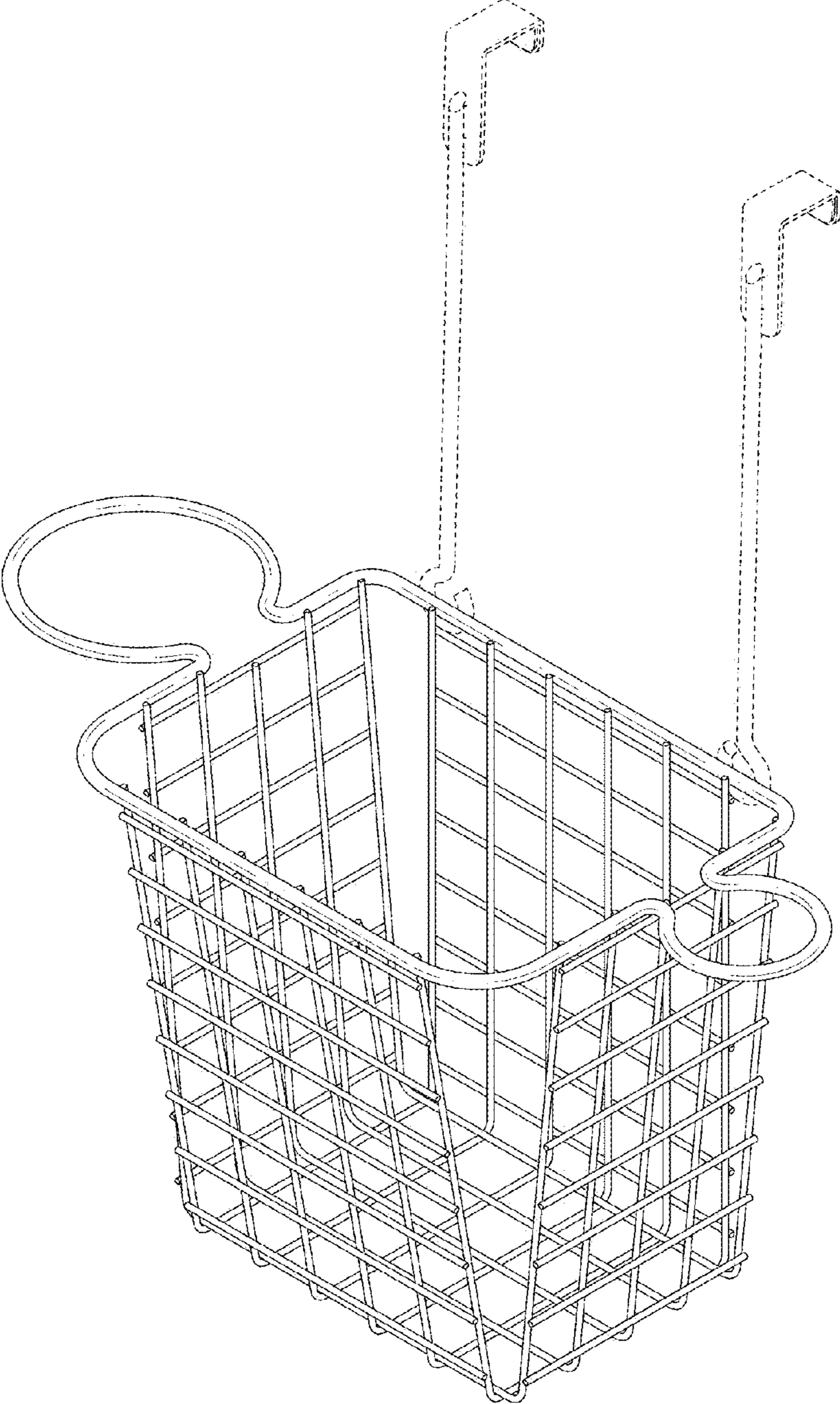

FIG 1

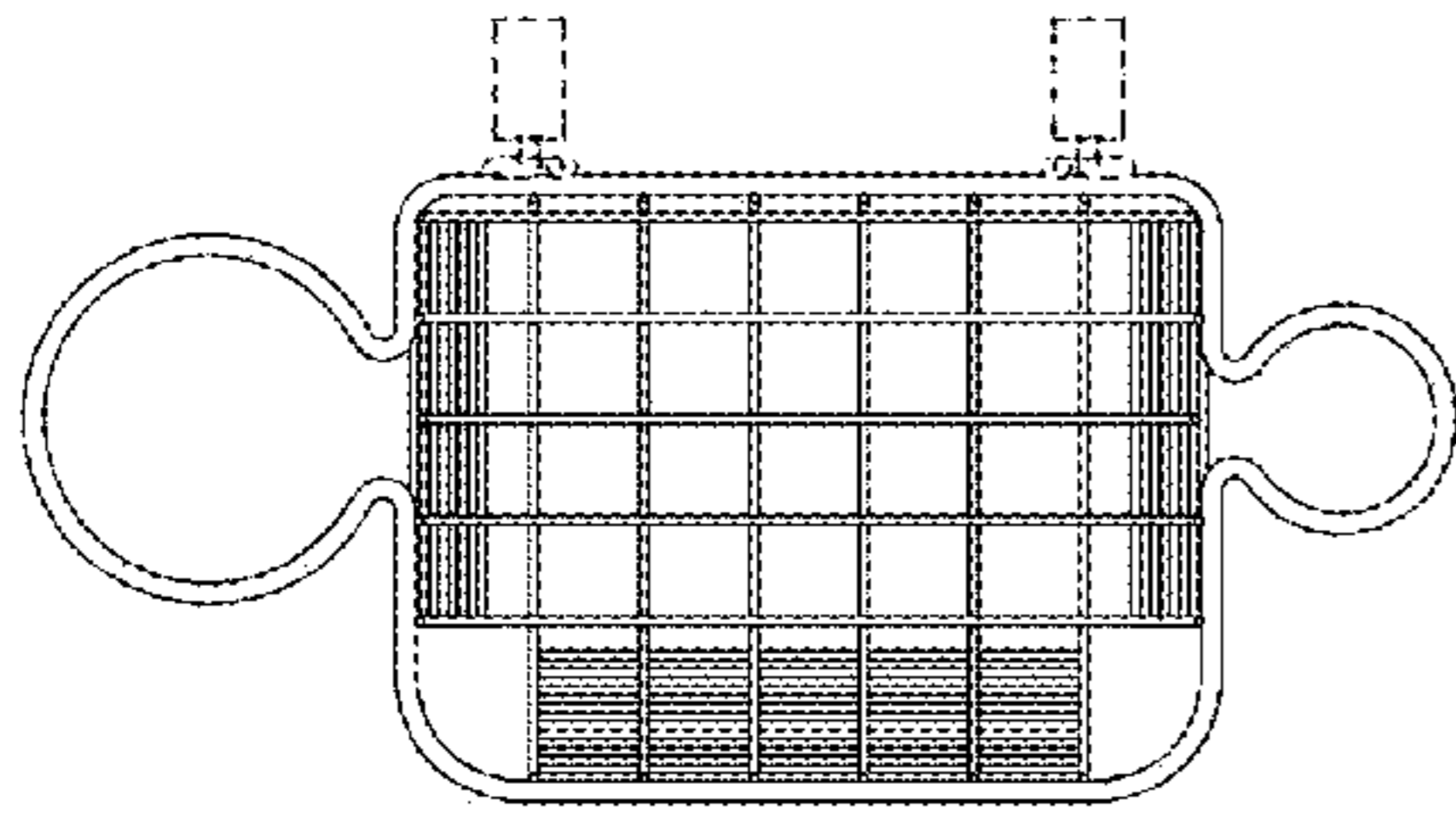

FIG 2

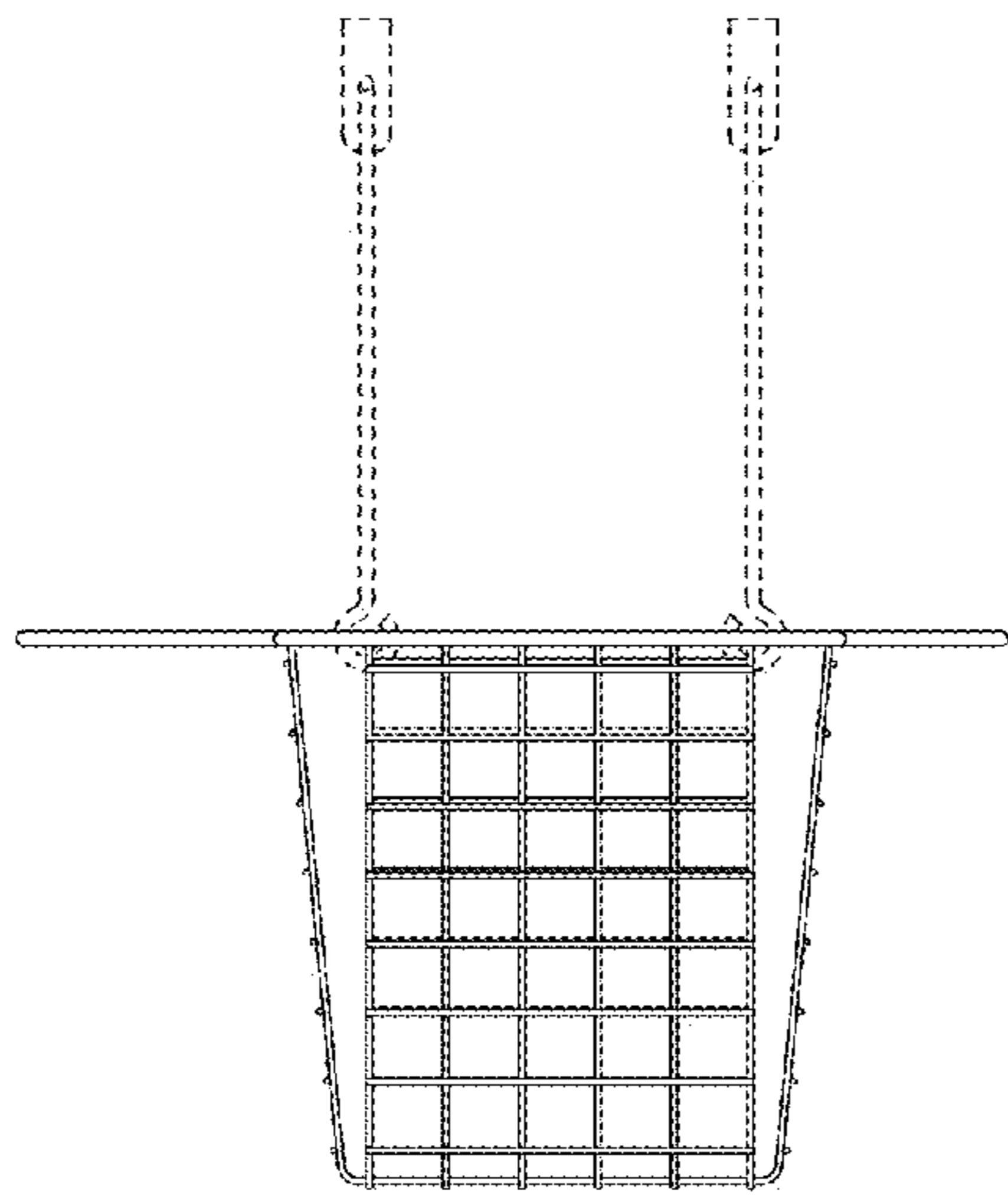

FIG 3

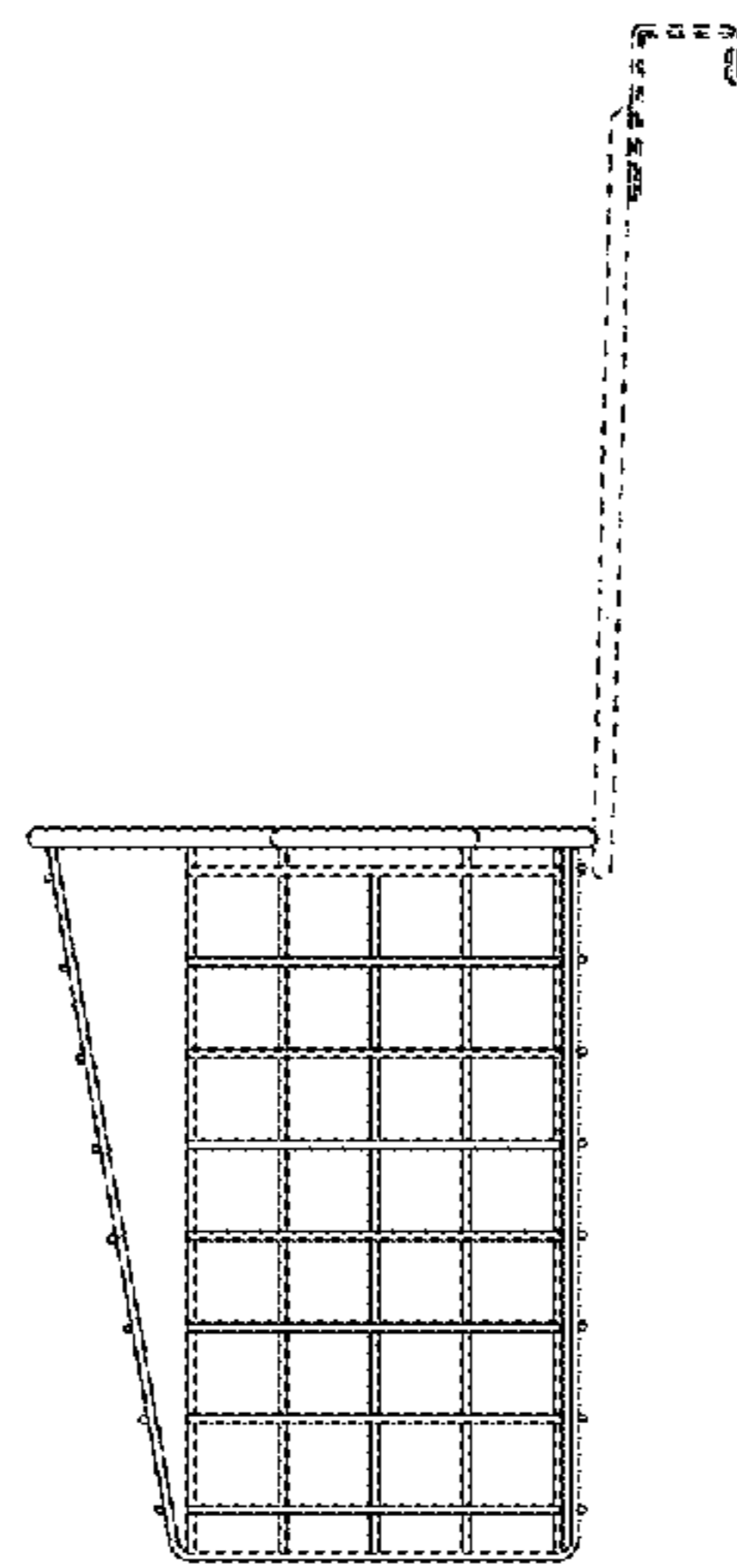

FIG 4

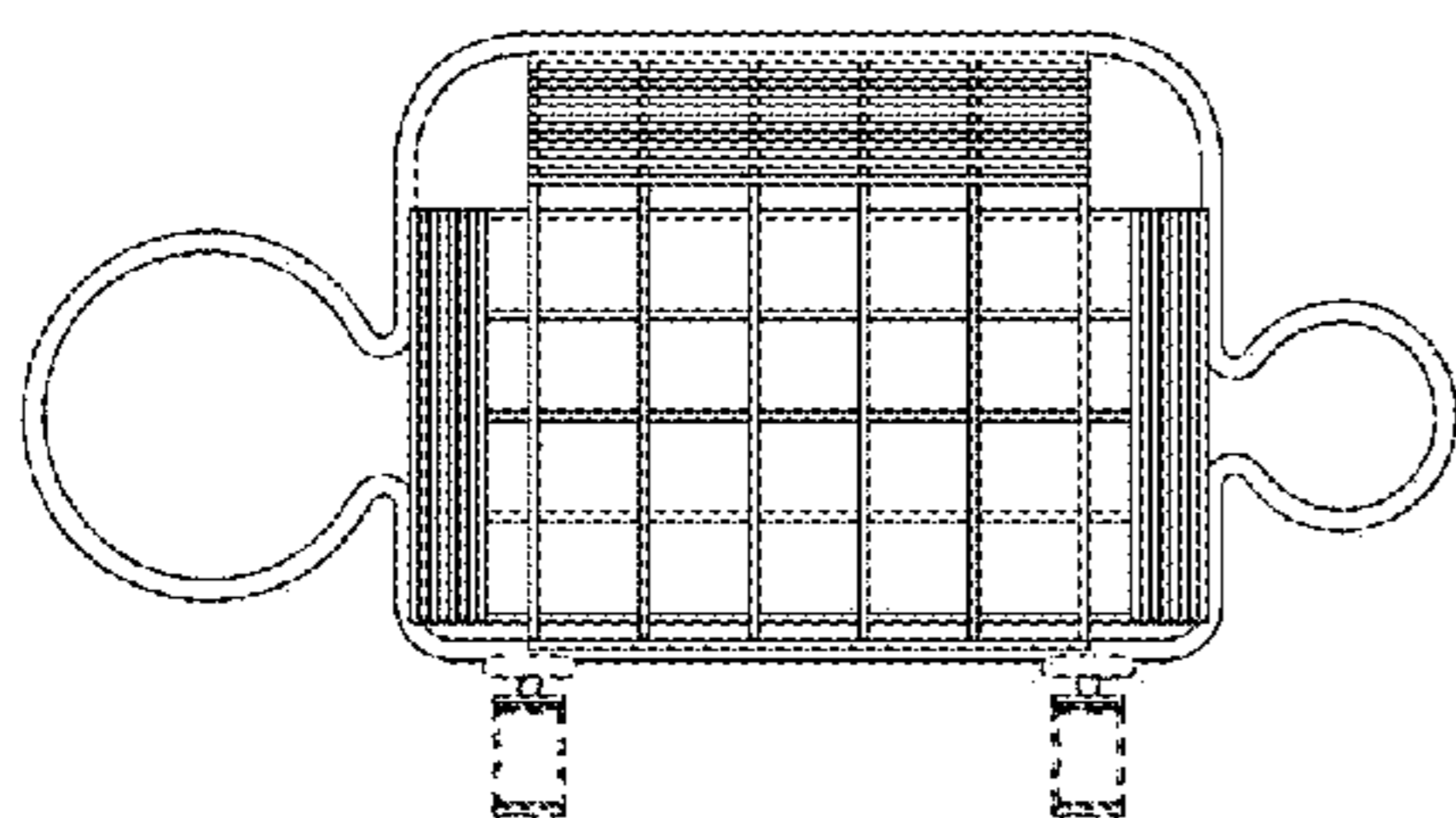

FIG 6

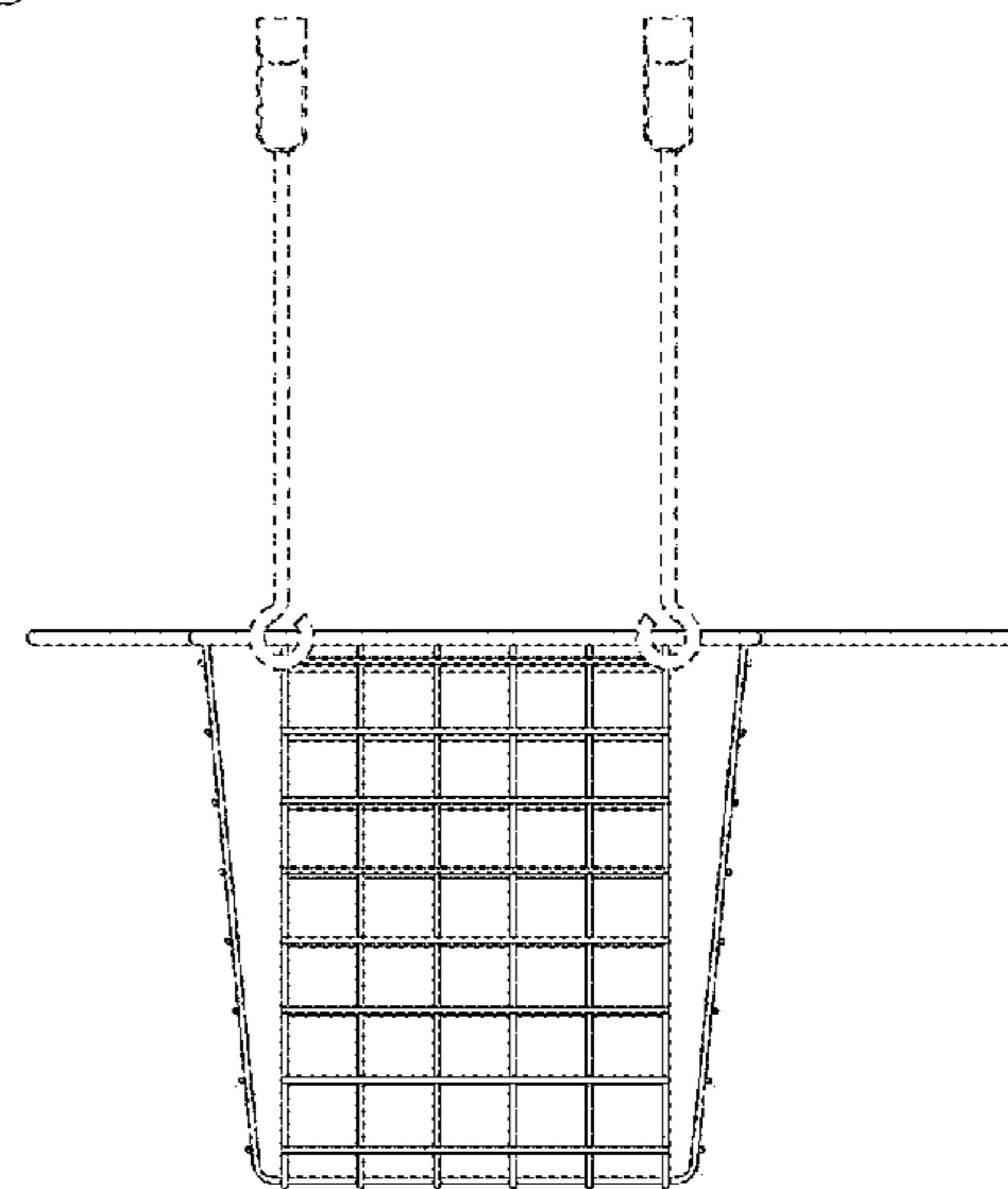

FIG 5