



US00D747849S

(12) **United States Design Patent**  
**Ingram**

(10) **Patent No.:** **US D747,849 S**  
(45) **Date of Patent:** **\*\* Jan. 26, 2016**

- (54) **UPPER BODY GARMENT**
- (71) Applicant: **NIKE, Inc.**, Beaverton, OR (US)
- (72) Inventor: **Jeff Ingram**, Beaverton, OR (US)
- (73) Assignee: **NIKE, Inc.**, Beaverton, OR (US)
- (\*\*) Term: **15 Years**
- (21) Appl. No.: **29/528,462**
- (22) Filed: **May 28, 2015**
- (51) **LOC (10) Cl.** ..... **02-02**
- (52) **U.S. Cl.**  
USPC ..... **D2/829**
- (58) **Field of Classification Search**  
USPC ..... D2/717, 731, 749, 750, 755, 828-831,  
D2/833, 834, 836, 839, 840, 841  
See application file for complete search history.

- D713,128 S 9/2014 Pezzimenti et al.
- D714,022 S 9/2014 Mong et al.
- D714,527 S \* 10/2014 Borovicka ..... D2/839
- D734,922 S \* 7/2015 Docker ..... D2/829
- 2013/0276201 A1\* 10/2013 Pezzimenti ..... A41D 13/002  
2/69

**OTHER PUBLICATIONS**

Nike Apparel Catalog, 2010 Fall ACG, p. 16, published date unknown, but prior to the filing date of the present application, NIKE, Inc.  
 Nike Apparel Catalog, 2010 Fall ACG, p. 4, published date unknown, but prior to the filing date of the present application, NIKE, Inc.

(Continued)

*Primary Examiner* — Rashida Johnson  
 (74) *Attorney, Agent, or Firm* — Banner & Witcoff, Ltd.

(57) **CLAIM**  
 The ornamental design for a upper body garment, as shown and described.

(56) **References Cited**  
**U.S. PATENT DOCUMENTS**

- D113,203 S 1/1939 Feigenbaum
- D113,204 S 1/1939 Zucker et al.
- 3,398,406 A \* 8/1968 Waterbury ..... B63C 9/087  
2/2.5
- 4,084,264 A \* 4/1978 Marion ..... A41D 13/0156  
2/16
- D298,474 S \* 11/1988 Twede ..... D29/100
- D622,032 S 8/2010 Lambertz
- D622,033 S 8/2010 Lambertz
- D622,034 S 8/2010 Lambertz
- D622,035 S 8/2010 Lambertz
- D626,725 S 11/2010 Snyder et al.
- D675,400 S 2/2013 Mertes
- D693,095 S 11/2013 Grant
- D698,523 S \* 2/2014 Roberts ..... D2/829
- D702,419 S 4/2014 Mertes
- D704,418 S \* 5/2014 Holmes ..... D2/839
- D707,423 S 6/2014 Pezzimenti
- D707,424 S 6/2014 Pezzimenti
- D710,573 S 8/2014 Pezzimenti

**DESCRIPTION**

FIG. 1 is a front right perspective view of a upper body garment showing my new design in an in-use configuration; FIG. 2 is a front left perspective view thereof; FIG. 3 is a front view thereof; FIG. 4 is a rear view thereof; FIG. 5 is a right side view thereof; FIG. 6 is a left side view thereof; FIG. 7 is a top view thereof; and, FIG. 8 is a bottom view thereof.  
 The broken lines immediately adjacent to the shaded area represent unclaimed boundaries of the design. The unshaded regions, demarcated by broken lines, represent unclaimed portions of the upper body garment and form no part of the claimed design. The contrast in shading represents a contrast of appearance and does not represent any particular color, texture, or material.

**1 Claim, 8 Drawing Sheets**

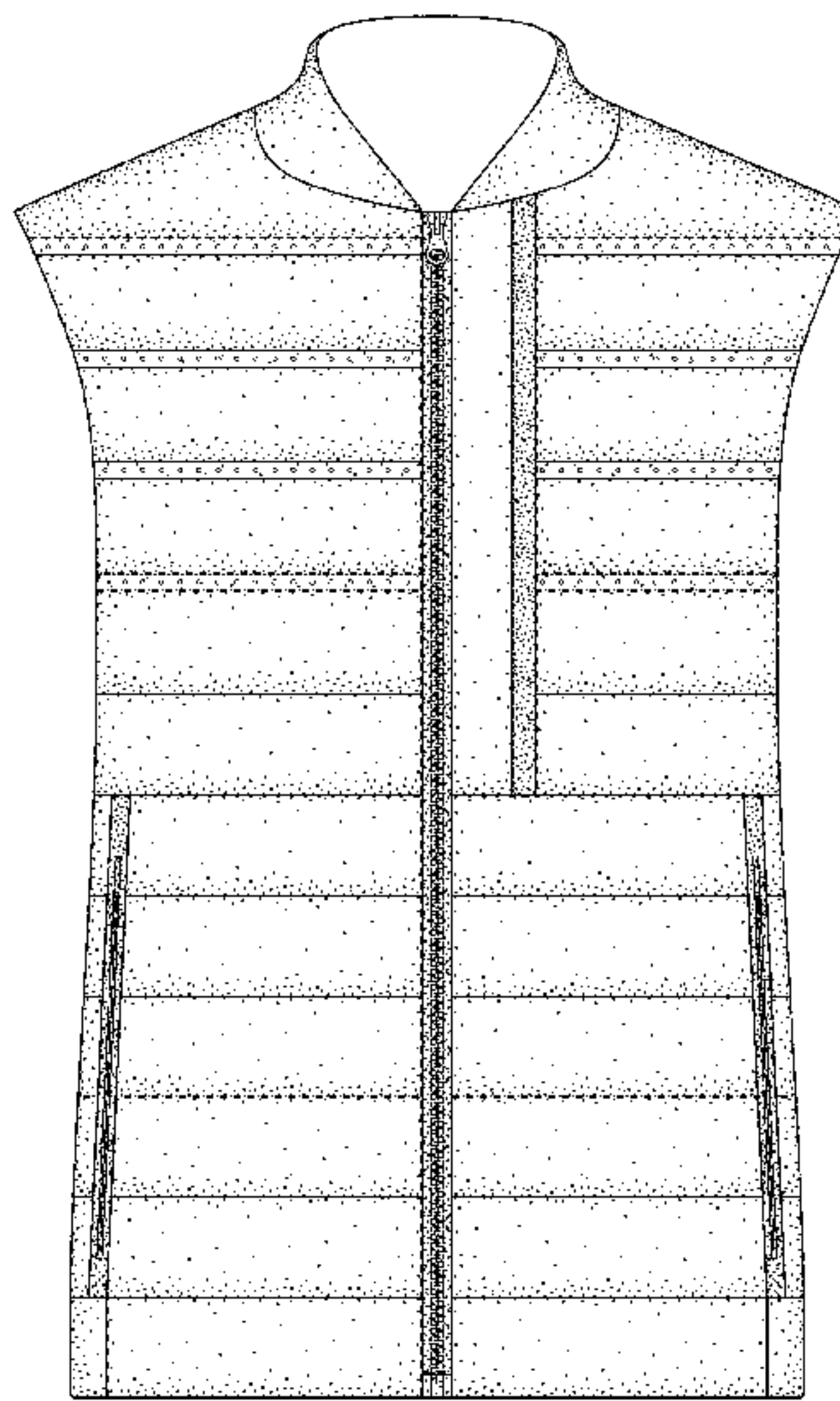
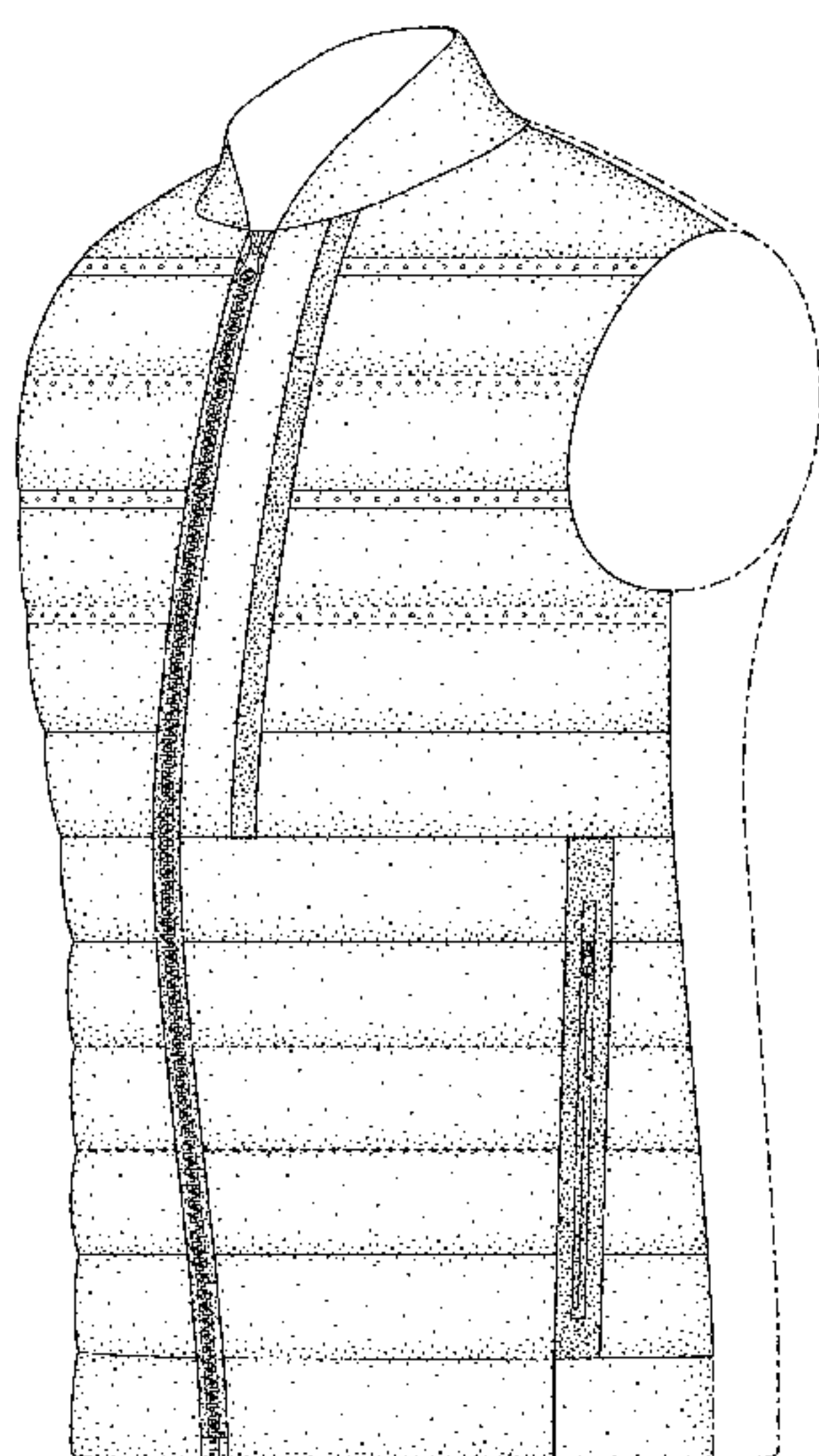

(56)

**References Cited**

OTHER PUBLICATIONS

Nike Apparel Catalog, 2010 Fall Apparel, p. 20, published date unknown, but prior to the filing date of the present application, NIKE, Inc.

Nike Apparel Catalog, 2010 Holiday Women's Athletic Dept Classics, p. 9, published date unknown, but prior to the filing date of the present application, NIKE, Inc.

Nike Apparel Catalog, 2010 Holiday Young Athletes, p. 47, published date unknown, but prior to the filing date of the present application, NIKE, Inc.

Nike Apparel Catalog, 2010 Holiday Young Athletes, p. 62, published date unknown, but prior to the filing date of the present application, NIKE, Inc.

Nike Apparel Catalog, 2011 Fall Boys Apparel Catalog, p. 22, published date unknown, but prior to the filing date of the present application, NIKE, Inc.

Nike Apparel Catalog, 2011 Fall Men's Athletic Dept Classics Catalog, p. 57, published date unknown, but prior to the filing date of the present application, NIKE, Inc.

Nike Apparel Catalog, 2011 Holiday Boys, p. 25, published date unknown, but prior to the filing date of the present application, NIKE, Inc.

Nike Apparel Catalog, 2011 Holiday Girls, p. 12, published date unknown, but prior to the filing date of the present application, NIKE, Inc.

Nike Apparel Catalog, 2011 Holiday Men's Athletic Dept Classic, p. 1, published date unknown, but prior to the filing date of the present application, NIKE, Inc.

Nike Apparel Catalog, 2011 Holiday Women's Performance, p. 51, published date unknown, but prior to the filing date of the present application, NIKE, Inc.

Nike Apparel Catalog, 2010 Fall ACG, p. 15, published date unknown, but prior to the filing date of the present application, NIKE, Inc.

\* cited by examiner



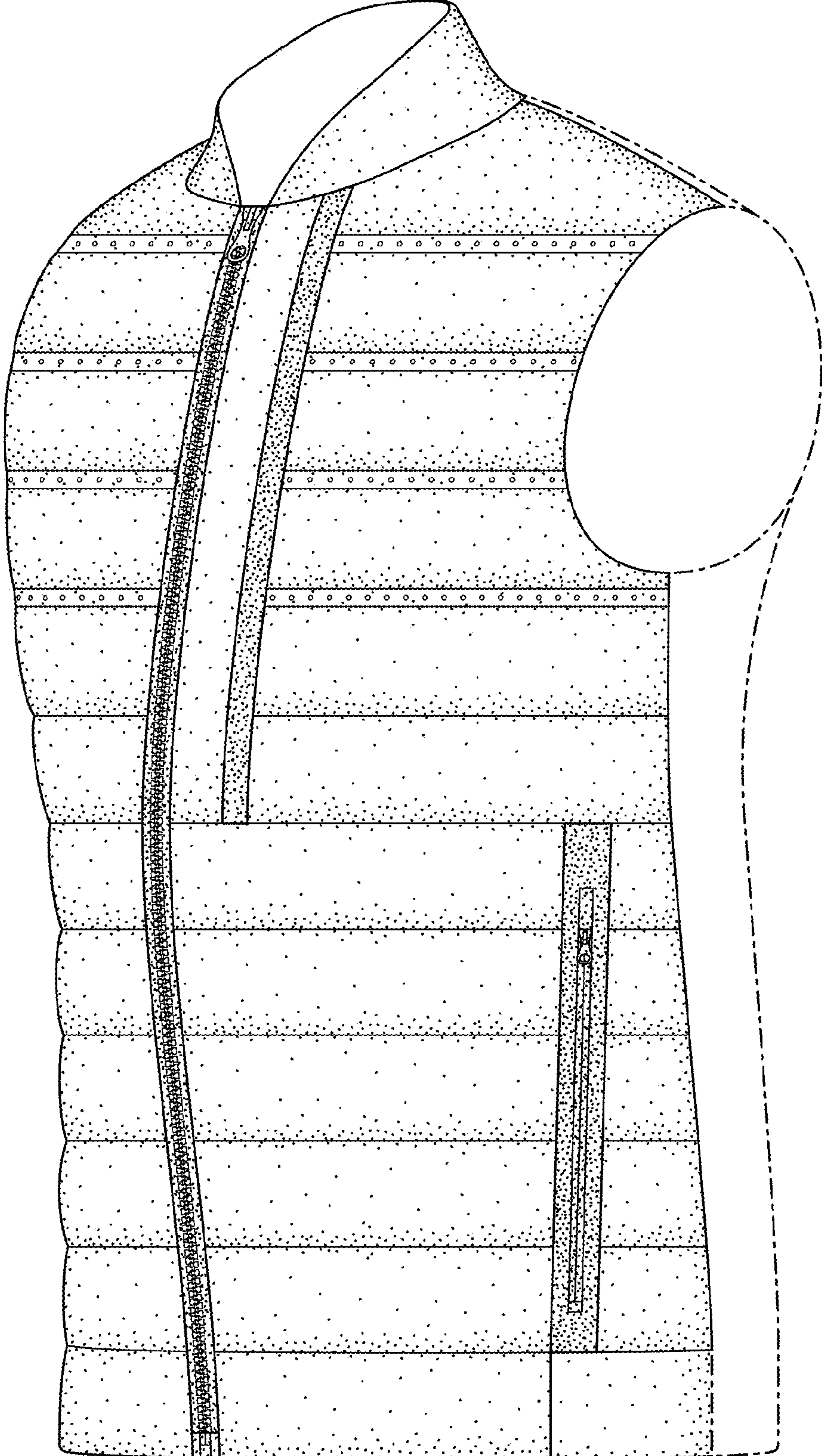

FIG. 1

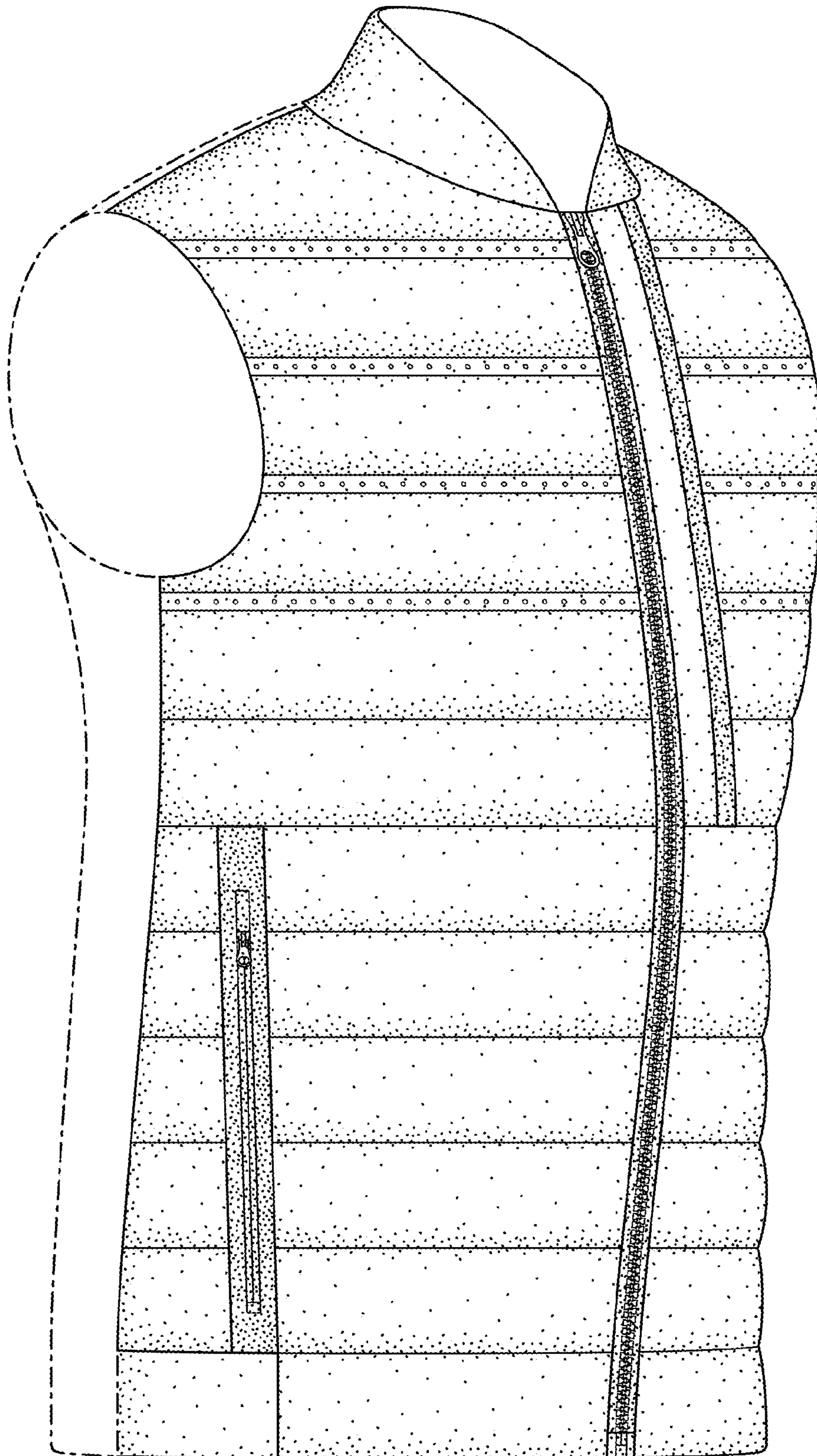

FIG. 2

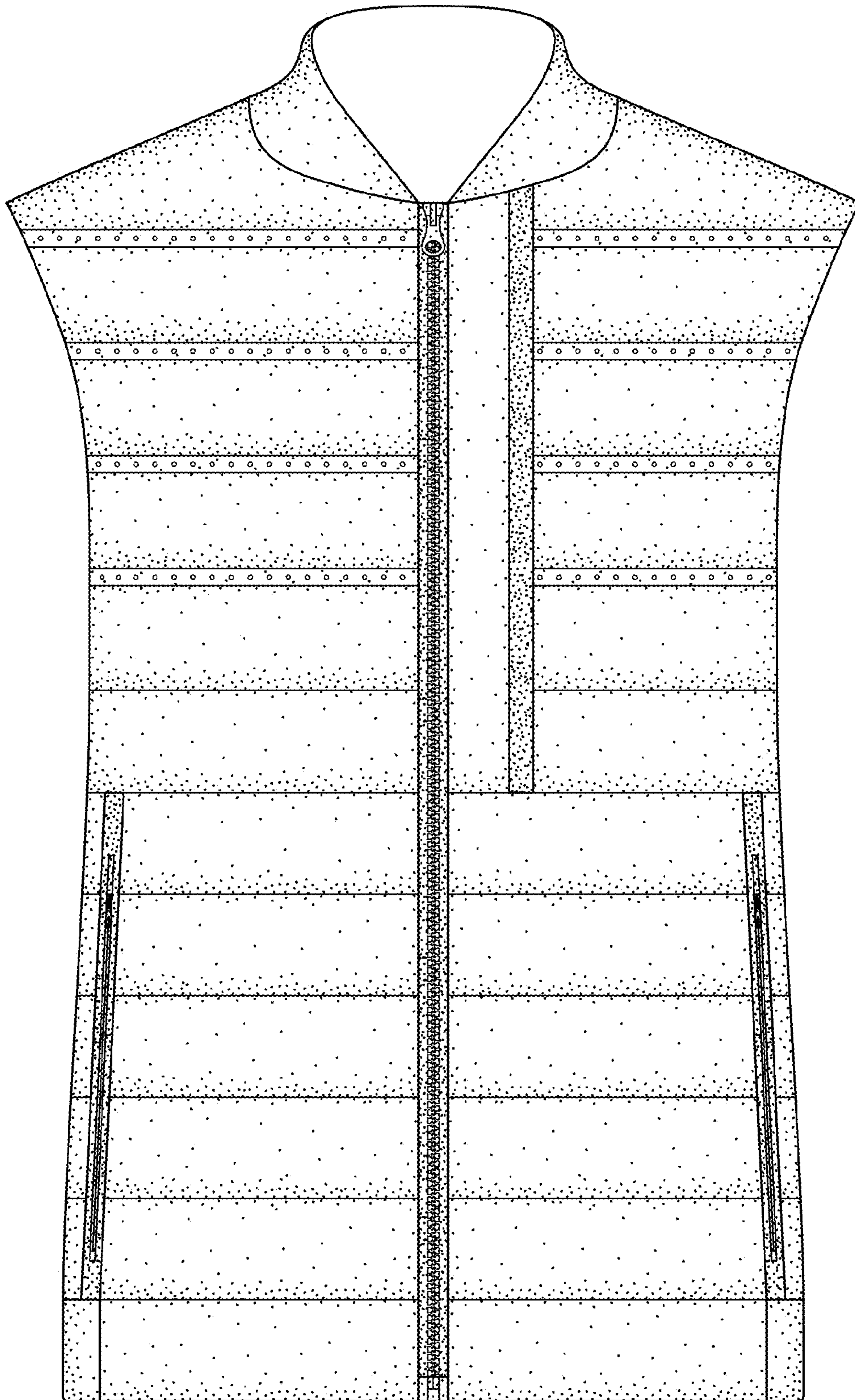

FIG. 3



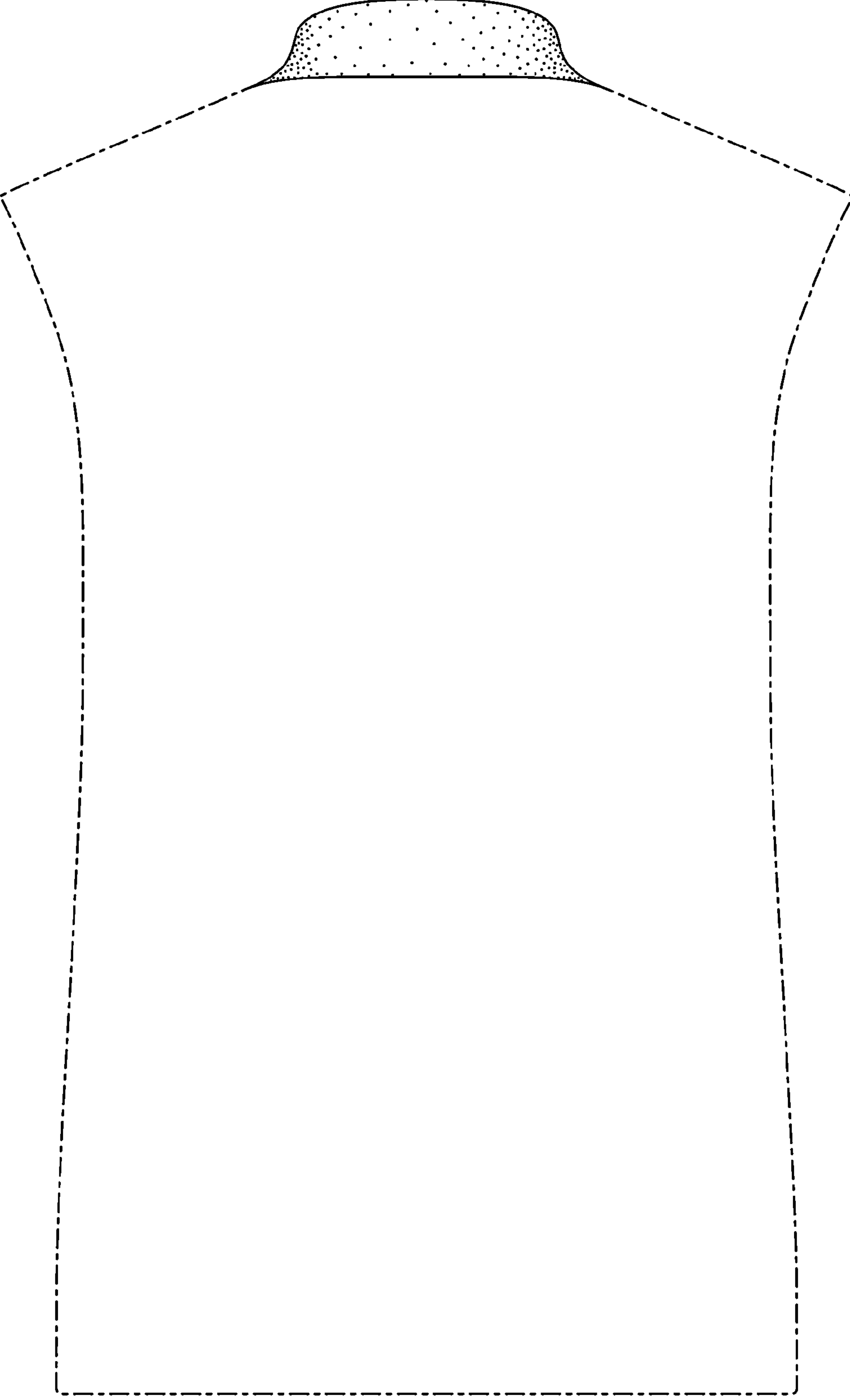

FIG. 4

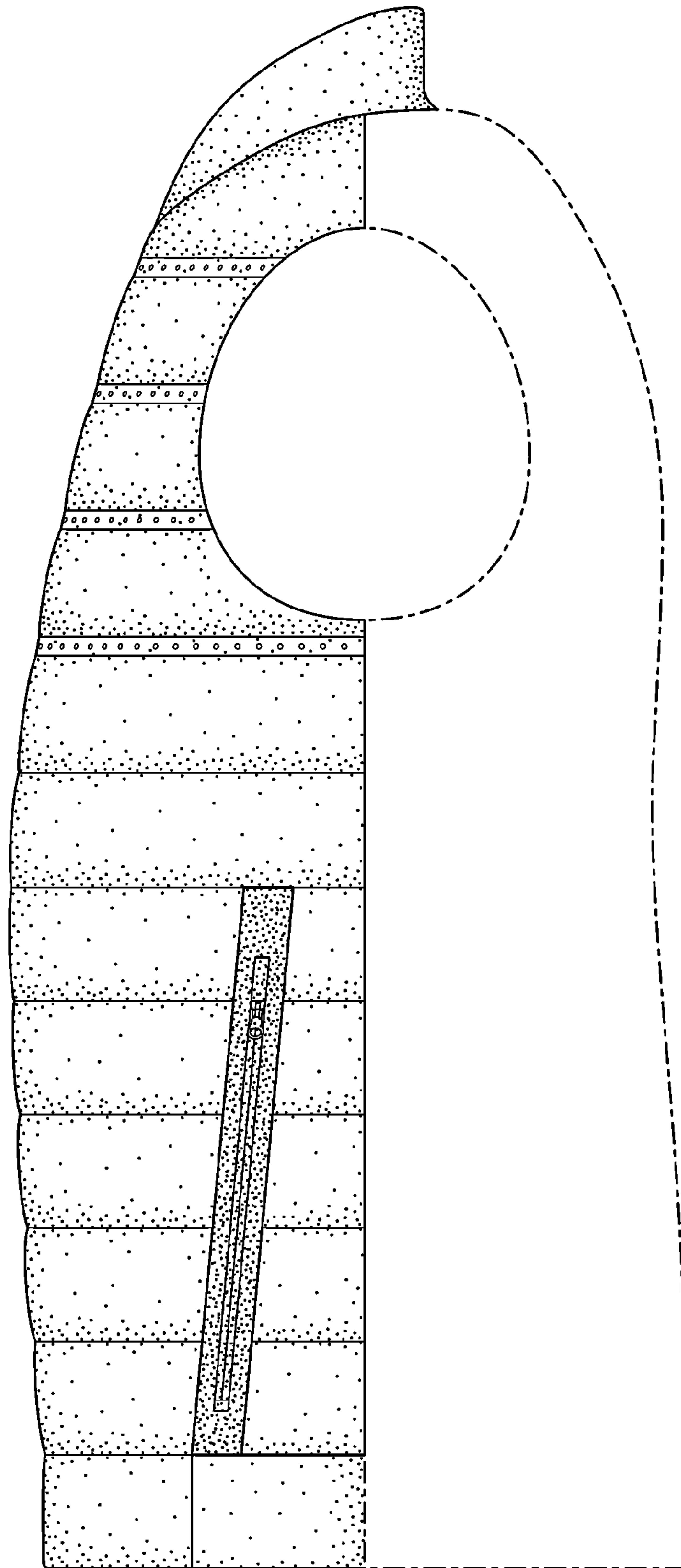

FIG. 5

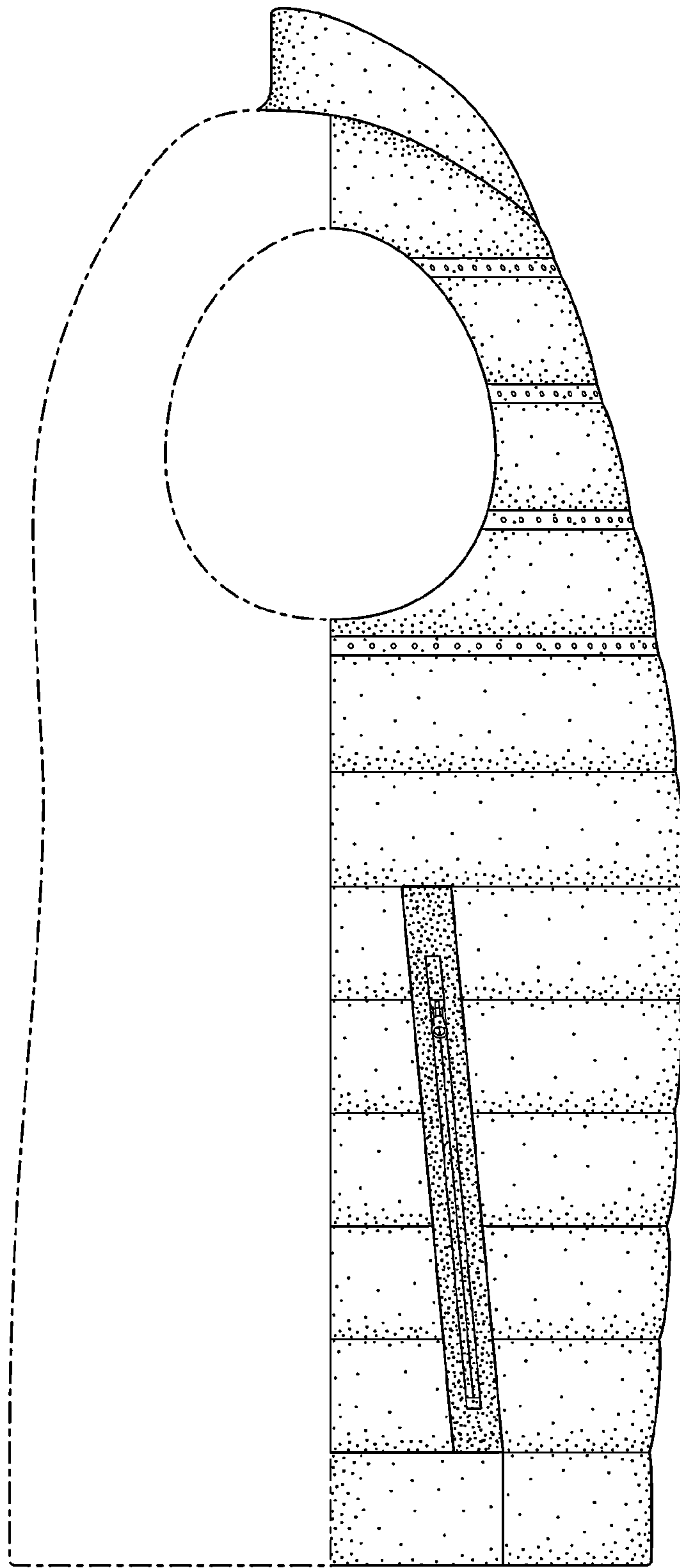

FIG. 6



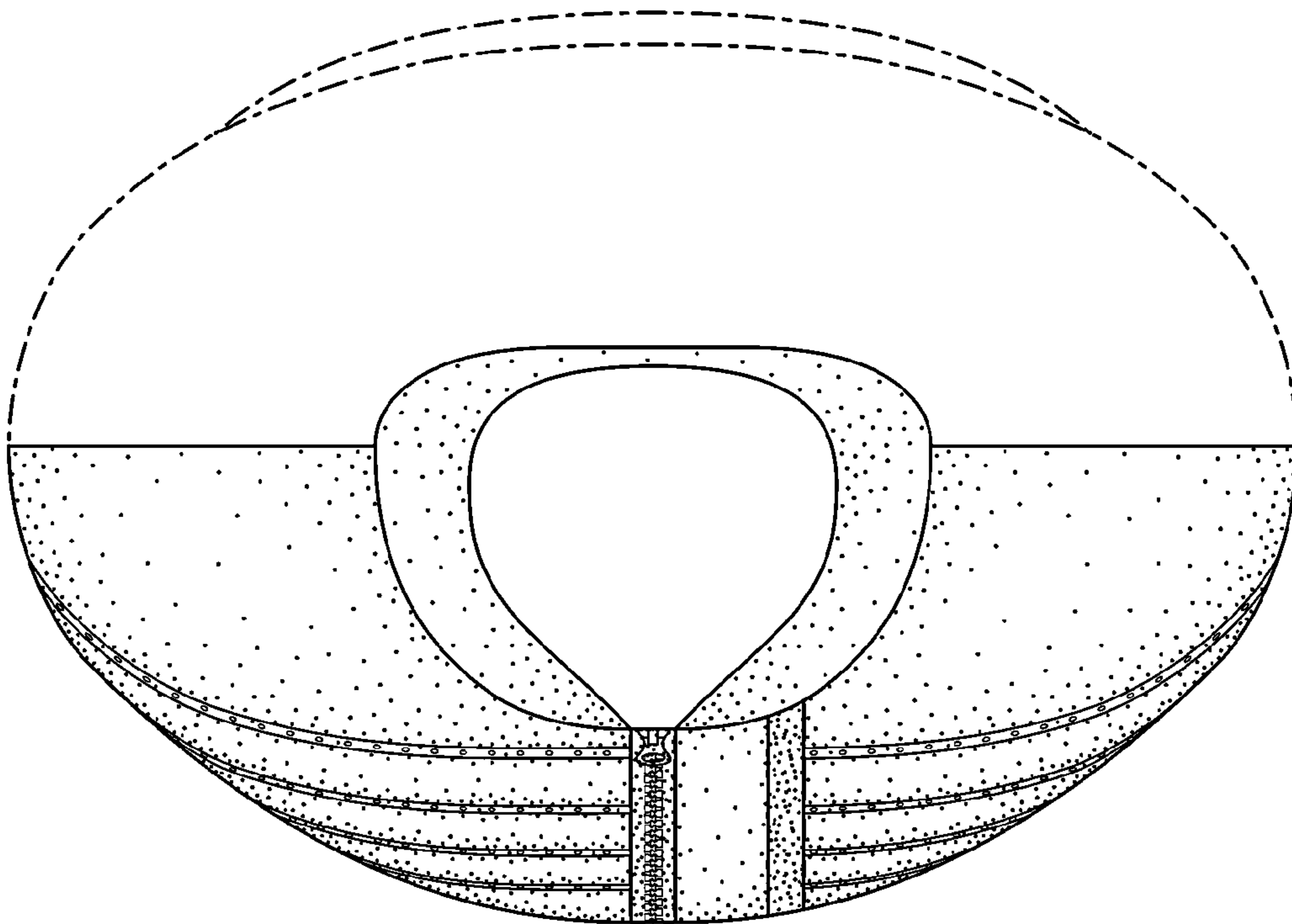

FIG. 7

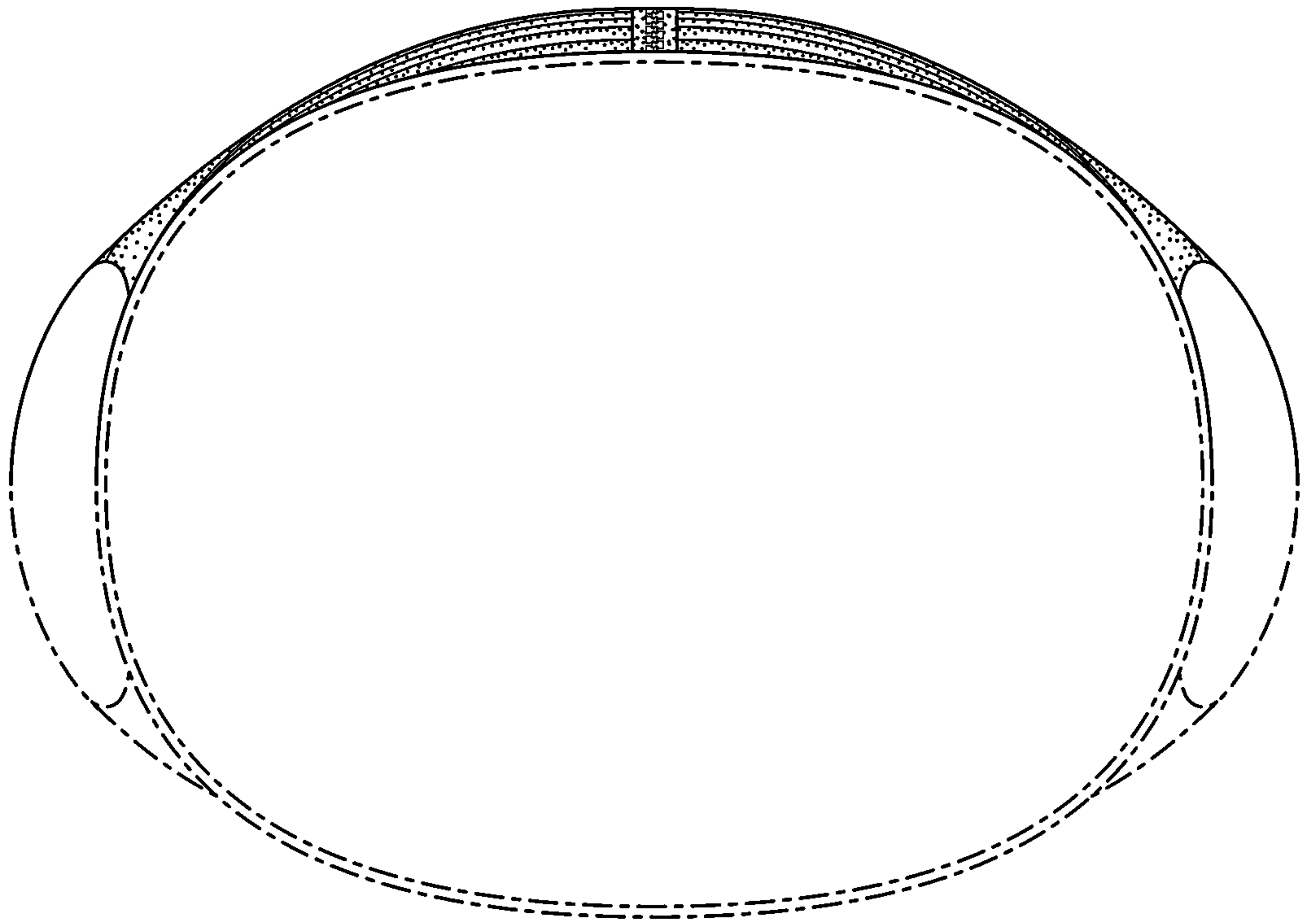

FIG. 8