



US00D747848S

(12) **United States Design Patent**
Sanders

(10) **Patent No.:** **US D747,848 S**
(45) **Date of Patent:** **** Jan. 26, 2016**

- (54) **SHAWL**
- (71) Applicant: **Jennifer N. Sanders**, Saugus, CA (US)
- (72) Inventor: **Jennifer N. Sanders**, Saugus, CA (US)
- (**) Term: **14 Years**
- (21) Appl. No.: **29/506,068**
- (22) Filed: **Oct. 13, 2014**
- (51) **LOC (10) Cl.** **02-02**
- (52) **U.S. Cl.**
USPC **D2/823**
- (58) **Field of Classification Search**
USPC D2/823-826, 718-720;
D24/101.2-101.4
CPC ... A41D 3/02; A41D 15/04; A41D 2400/422;
A41D 3/00
See application file for complete search history.

- D619,333 S * 7/2010 Stowell D2/823
- D645,645 S * 9/2011 Dyer D2/823
- D714,524 S * 10/2014 Borovicka D2/825
- D726,996 S * 4/2015 Elliott D2/823

* cited by examiner

Primary Examiner — Ian Simmons
Assistant Examiner — Rashida C McCoy
(74) *Attorney, Agent, or Firm* — McCarter & English

(57) **CLAIM**
I claim the ornamental design for a shawl, as shown and described.

DESCRIPTION

FIG. 1 is a back view of the present invention as it is to be worn by the user;
FIG. 2 is a front view thereof as it is to be worn by the user;
FIG. 3 is a front view thereof in a flatten form;
FIG. 4 is a back view thereof in a flatten form;
FIG. 5 is a front view thereof as worn by the user;
FIG. 6 is a back view thereof as worn by the user;
FIG. 7 is a left side view thereof as worn by the user;
FIG. 8 is a right side view thereof as worn by the user; and,
FIG. 9 is a front view as worn by the user.
The tightly spaced broken lines on the pockets of the shawl represent claimed stitching. The broken lines forming a person in the drawings represent environmental subject matter that forms no part of the claim.

(56) **References Cited**
U.S. PATENT DOCUMENTS

- D170,340 S * 9/1953 Salnyh 2/88
- D314,078 S * 1/1991 Wiederhold D2/823
- D363,156 S * 10/1995 Layman D2/719
- 6,578,204 B2 * 6/2003 Ozenkoski A41D 3/02
2/69
- D542,007 S * 5/2007 Huang D2/728
- D543,010 S * 5/2007 Erickson D2/823
- D557,967 S * 12/2007 Grant D2/823
- D613,106 S * 4/2010 Ward D2/719

1 Claim, 5 Drawing Sheets

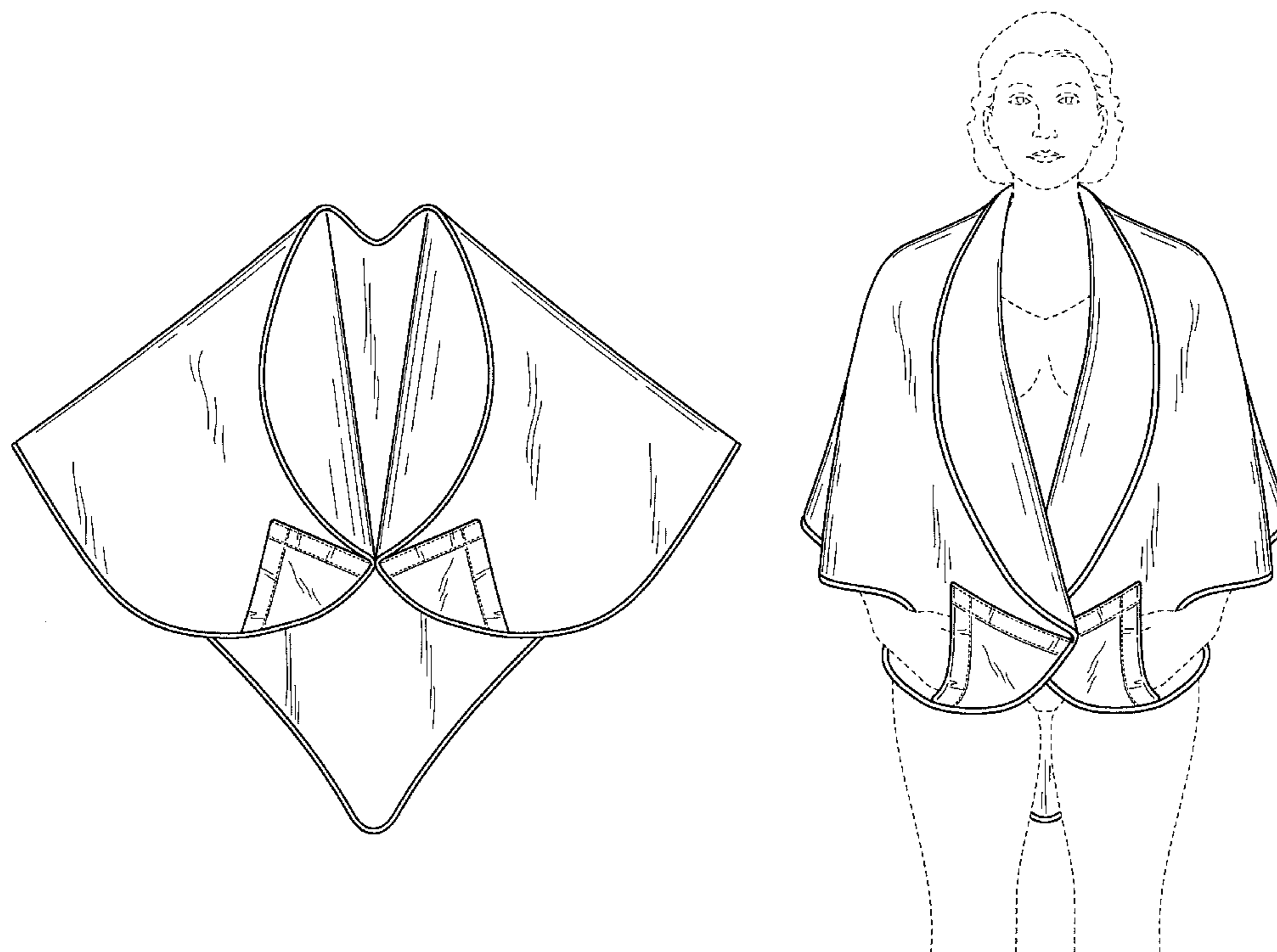

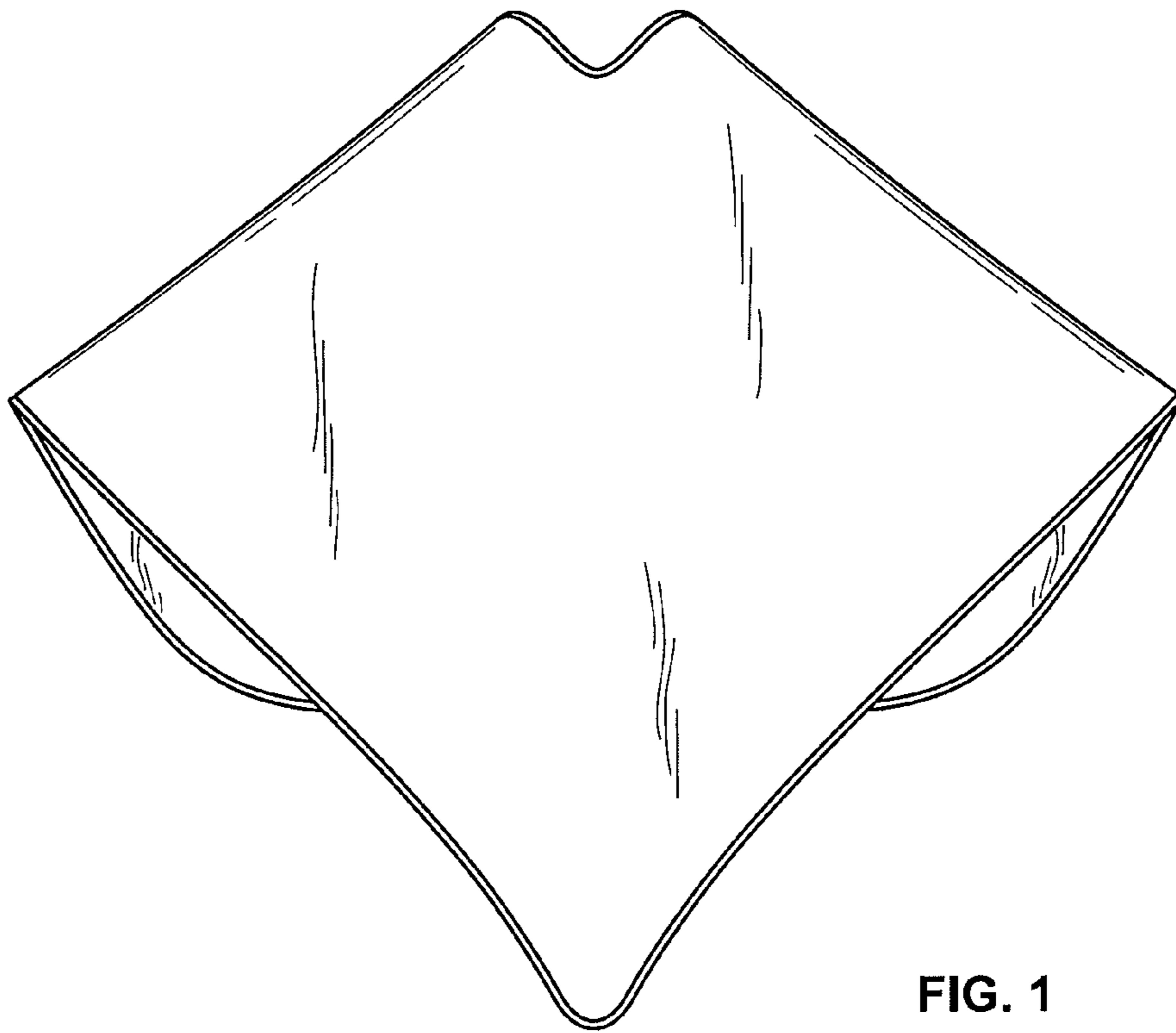

FIG. 1

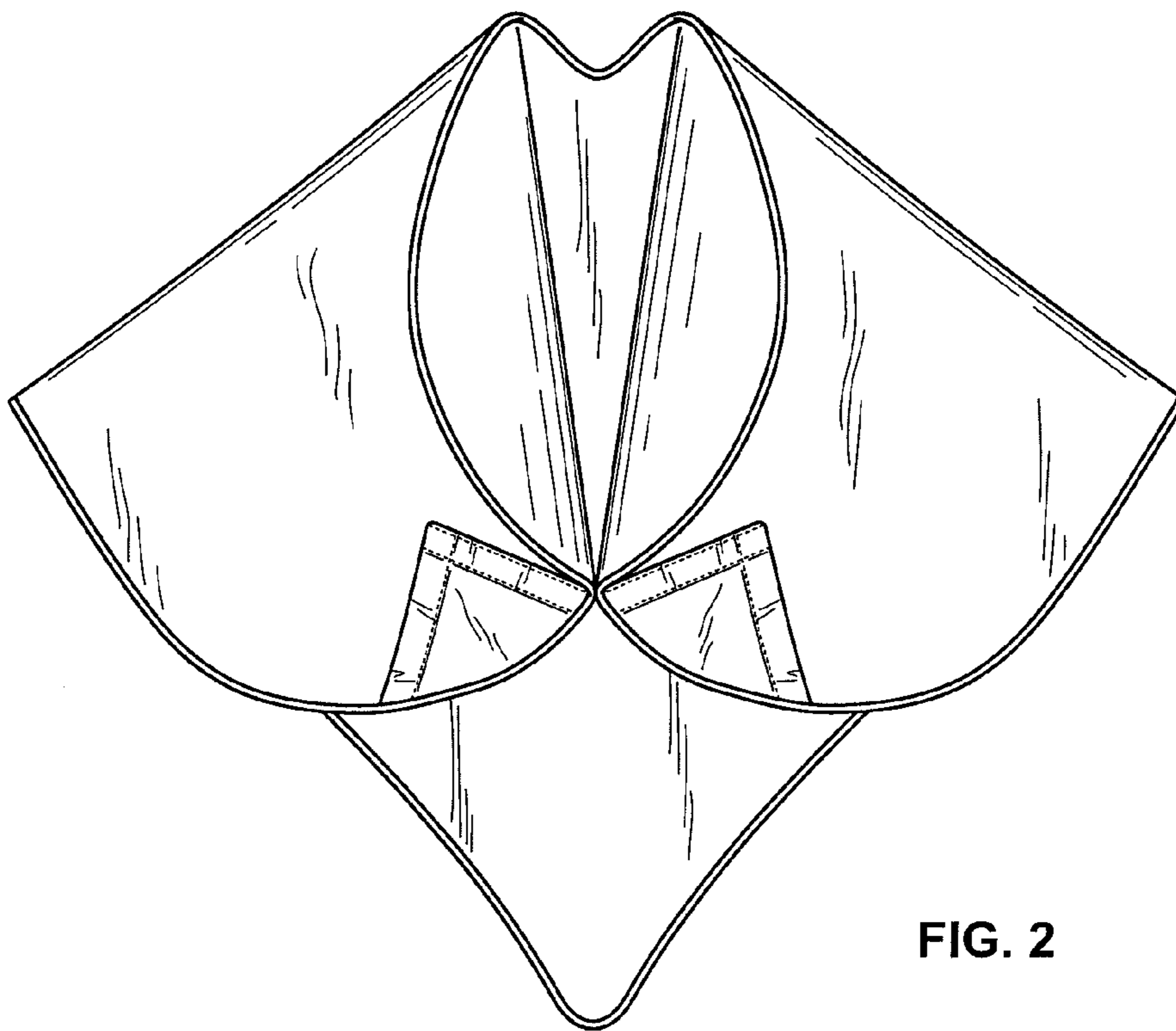

FIG. 2

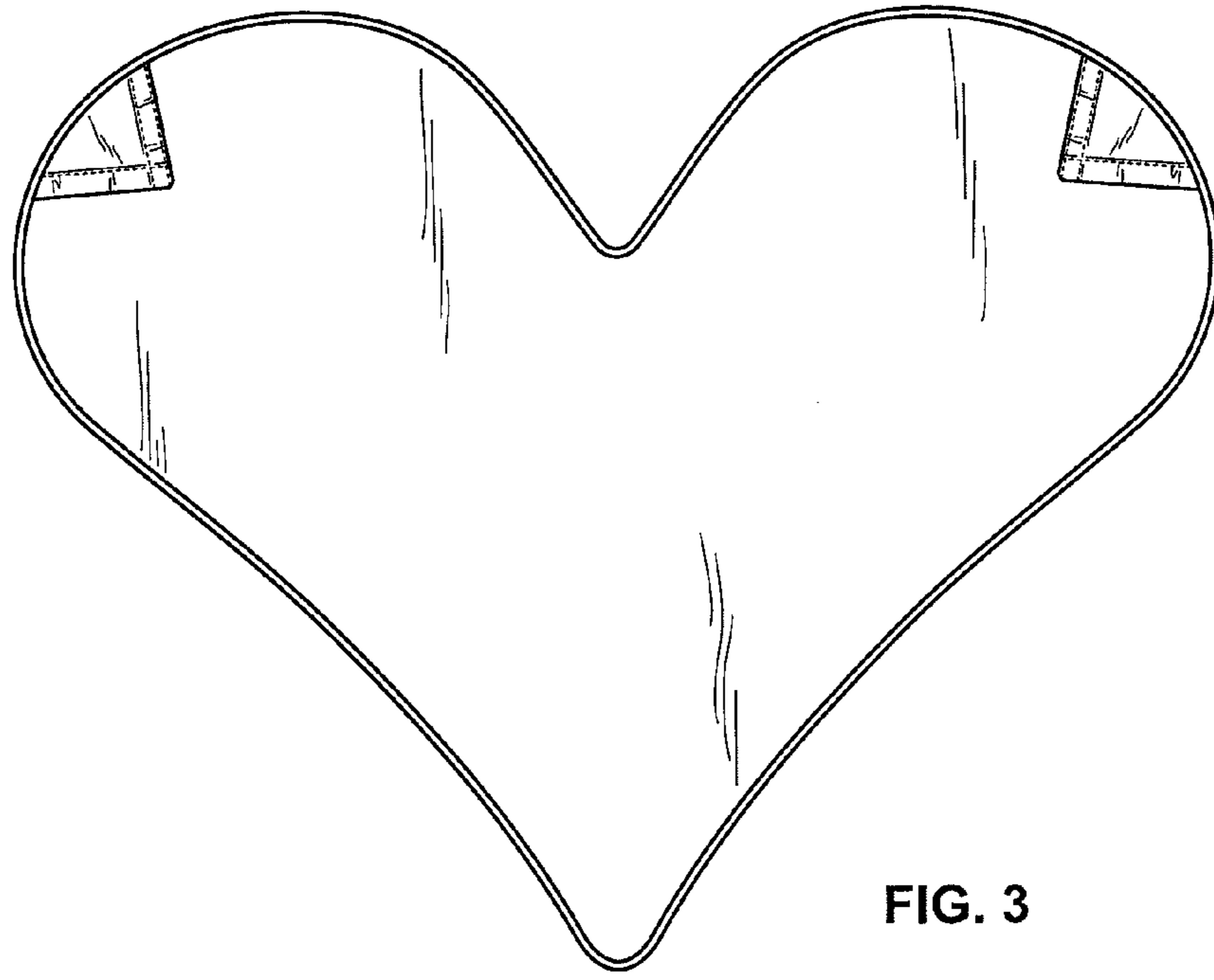

FIG. 3

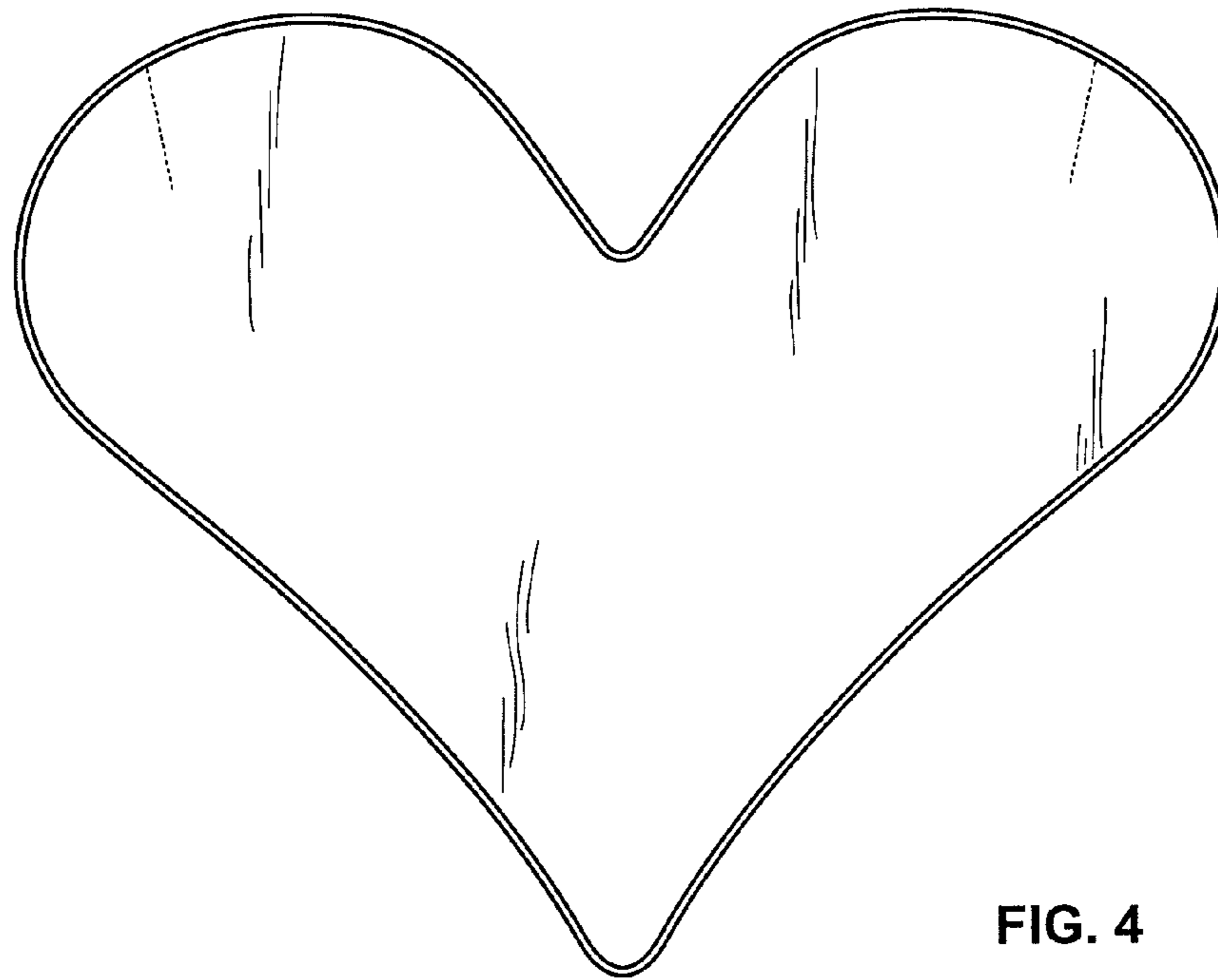

FIG. 4

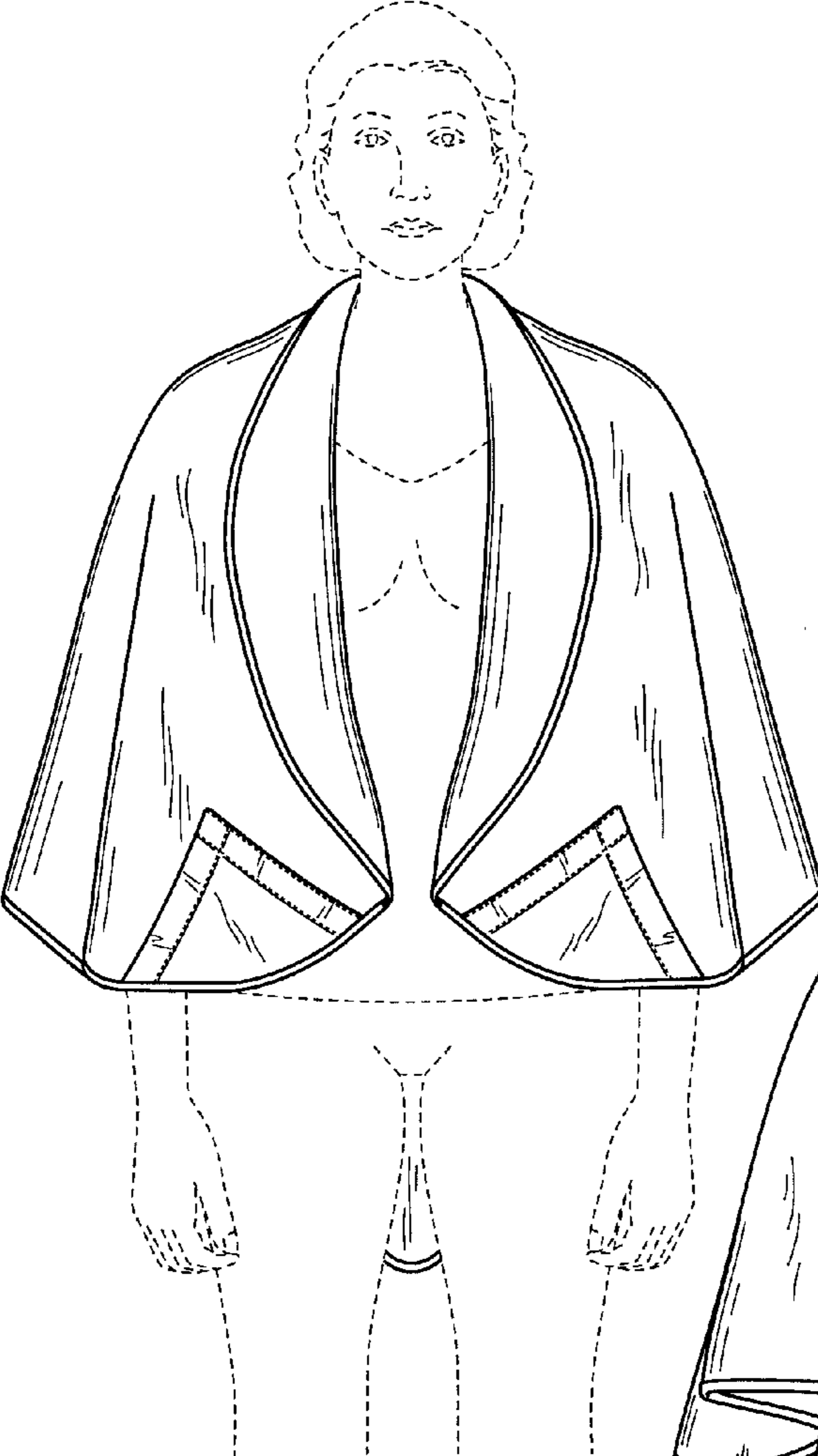

FIG. 5

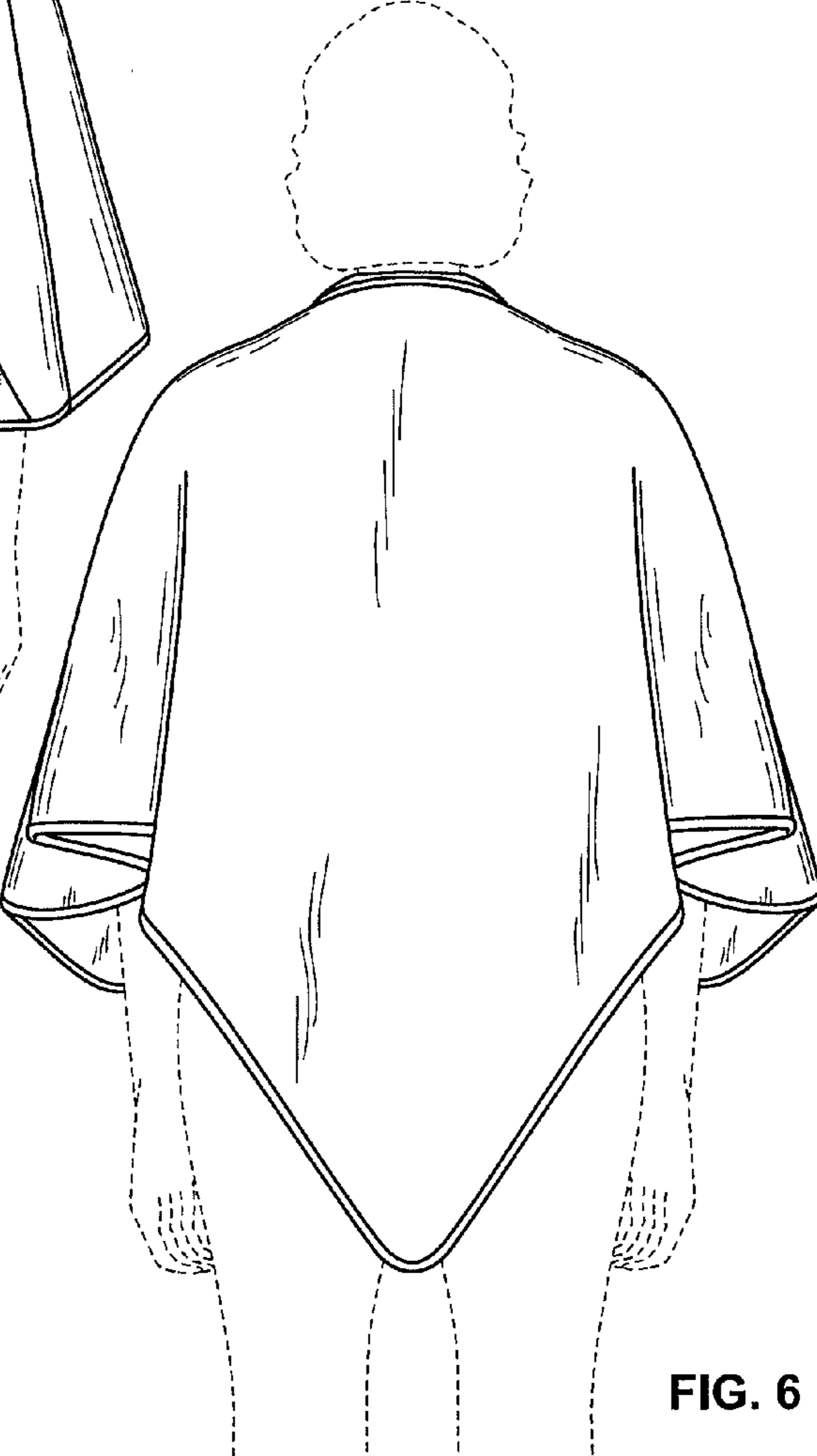

FIG. 6

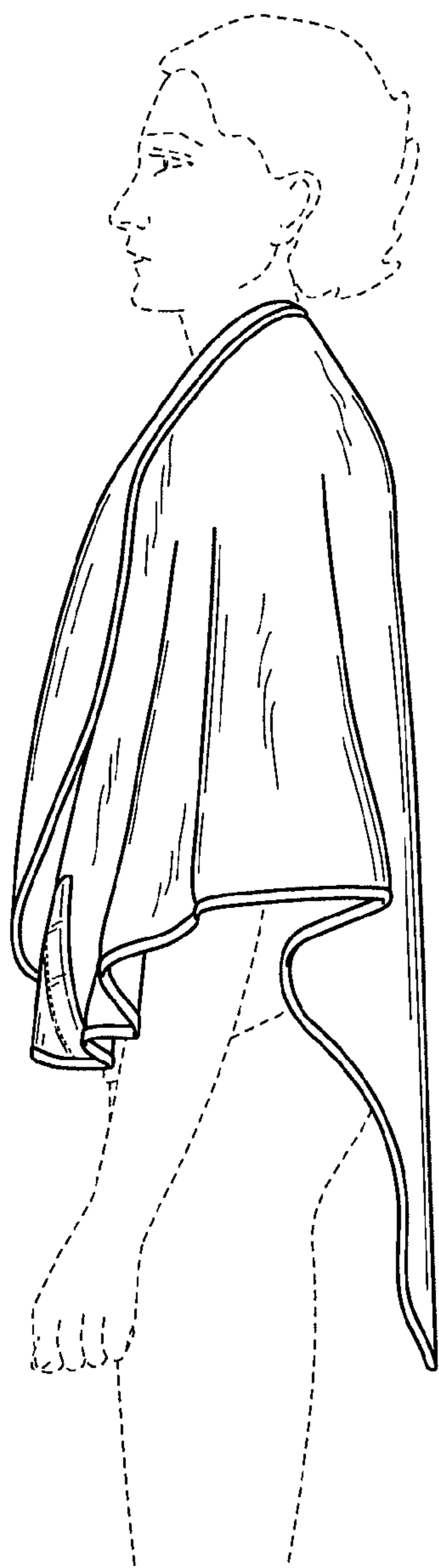

FIG. 7



FIG. 8

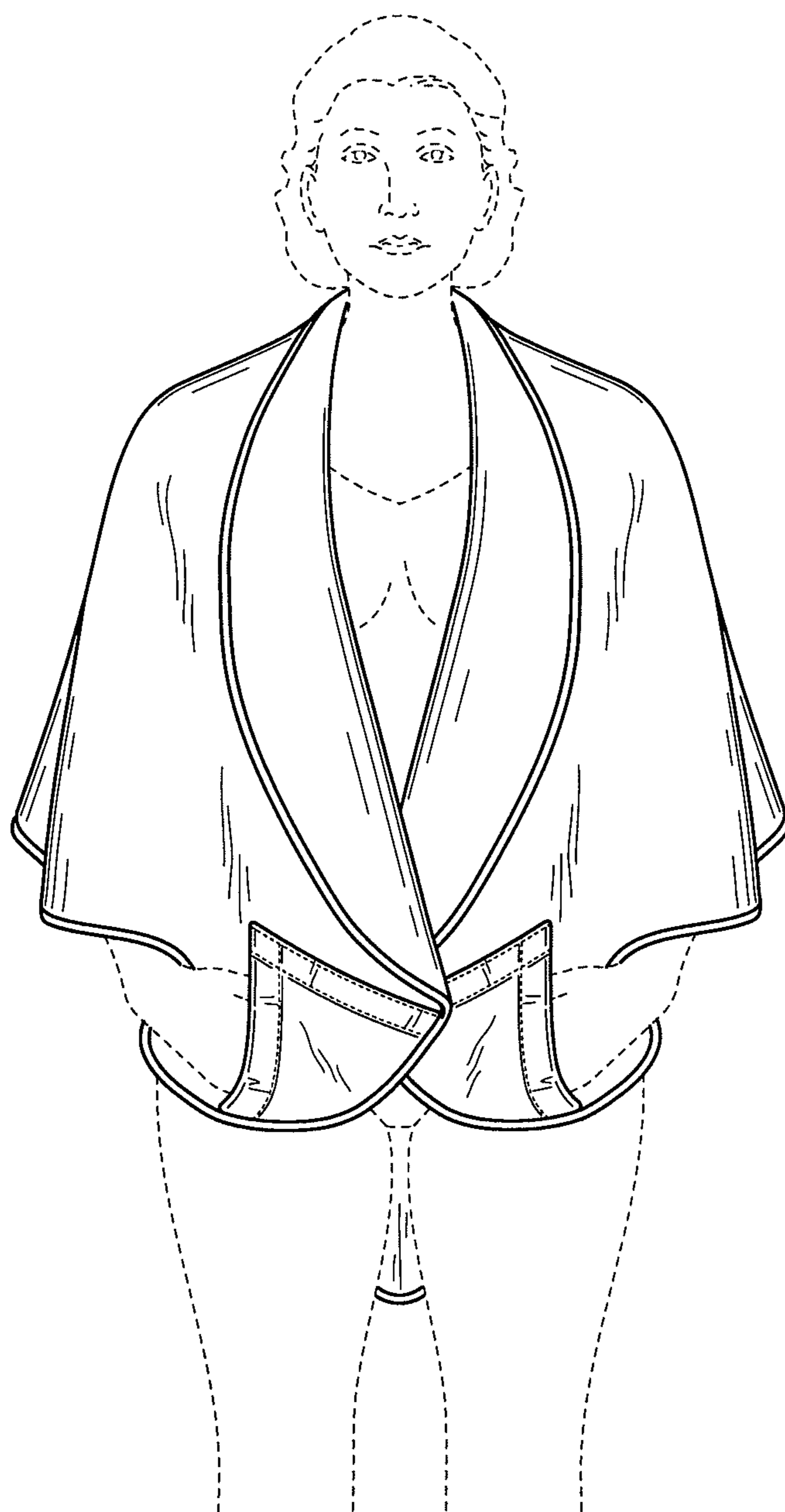

FIG. 9