



US00D747808S

(12) **United States Design Patent**  
**Ji**

(10) **Patent No.:** **US D747,808 S**

(45) **Date of Patent:** **\*\* Jan. 19, 2016**

(54) **ORTHODONTIC BRACKET**

(71) Applicant: **Li Ji**, Guangzhou (CN)

(72) Inventor: **Li Ji**, Guangzhou (CN)

(\*\*) Term: **14 Years**

(21) Appl. No.: **29/512,555**

(22) Filed: **Dec. 19, 2014**

(30) **Foreign Application Priority Data**

Jun. 20, 2014 (CN) ..... 2014 3 0193766

(51) **LOC (10) CL.** ..... **24-99**

(52) **U.S. Cl.**  
USPC ..... **D24/180**

(58) **Field of Classification Search**  
USPC ..... D24/155-156, 176, 180; 433/8-18  
CPC ..... A61C 7/12; A61C 7/14; A61C 7/00;  
A61C 7/28; A61C 7/145; A61C 7/143;  
A61C 7/141  
See application file for complete search history.

(56) **References Cited**

**U.S. PATENT DOCUMENTS**

2,011,575	A *	8/1935	Ford	.....	A61C 7/285 433/10
4,867,678	A *	9/1989	Parker	.....	A61C 7/12 433/8
D318,528	S *	7/1991	Bjork	.....	D24/180
7,104,791	B2 *	9/2006	Hanson	.....	A61C 7/145 433/10
7,204,690	B2 *	4/2007	Hanson	.....	A61C 7/145 433/10
7,210,927	B2 *	5/2007	Abels	.....	A61C 7/285 433/10
D606,201	S *	12/2009	Lawrence	.....	D24/180
7,963,768	B2 *	6/2011	Hilliard	.....	A61C 7/287 433/11
8,282,392	B2 *	10/2012	Hilliard	.....	A61C 7/287 433/11
8,998,607	B2 *	4/2015	Oda	.....	A61C 7/287 433/10

2005/0019718	A1 *	1/2005	Hanson	.....	A61C 7/145 433/10
2015/0017597	A1 *	1/2015	Solano Reina	.....	A61C 7/14 433/10
2015/0173860	A1 *	6/2015	Oda	.....	A61C 7/287 433/11

\* cited by examiner

*Primary Examiner* — Wan Laymon

(74) *Attorney, Agent, or Firm* — Hamre, Schumann, Mueller & Larson, P.C.

(57) **CLAIM**

The ornamental design for an orthodontic bracket, as shown and described.

**DESCRIPTION**

FIG. 1 is a front view of the orthodontic bracket with a bottom component and a cover fully assembled together showing my new design;

FIG. 2 is a rear view corresponding to FIG. 1;

FIG. 3 is a left side view corresponding to FIG. 1;

FIG. 4 is a right side view corresponding to FIG. 1;

FIG. 5 is a top view corresponding to FIG. 1;

FIG. 6 is a bottom view corresponding to FIG. 1;

FIG. 7 is a perspective view corresponding to FIG. 1;

FIG. 8 is a front view of the bottom component of FIG. 1 shown separately for ease of illustration;

FIG. 9 is a rear view corresponding to FIG. 8;

FIG. 10 is a left side view corresponding to FIG. 8;

FIG. 11 is a right side view corresponding to FIG. 8;

FIG. 12 is a top view corresponding to FIG. 8;

FIG. 13 is a bottom view corresponding to FIG. 8;

FIG. 14 is a perspective view corresponding to FIG. 8;

FIG. 15 is a front view of the cover portion of FIG. 1 shown separately for ease of illustration;

FIG. 16 is a rear view corresponding to FIG. 15;

FIG. 17 is a left side view corresponding to FIG. 15;

FIG. 18 is a right side view corresponding to FIG. 15;

FIG. 19 is a top view corresponding to FIG. 15;

FIG. 20 is a bottom view corresponding to FIG. 15;

FIG. 21 is a perspective view corresponding to FIG. 15;

FIG. 22 is a front view of the orthodontic bracket showing the cover is in an opened position during assembly;

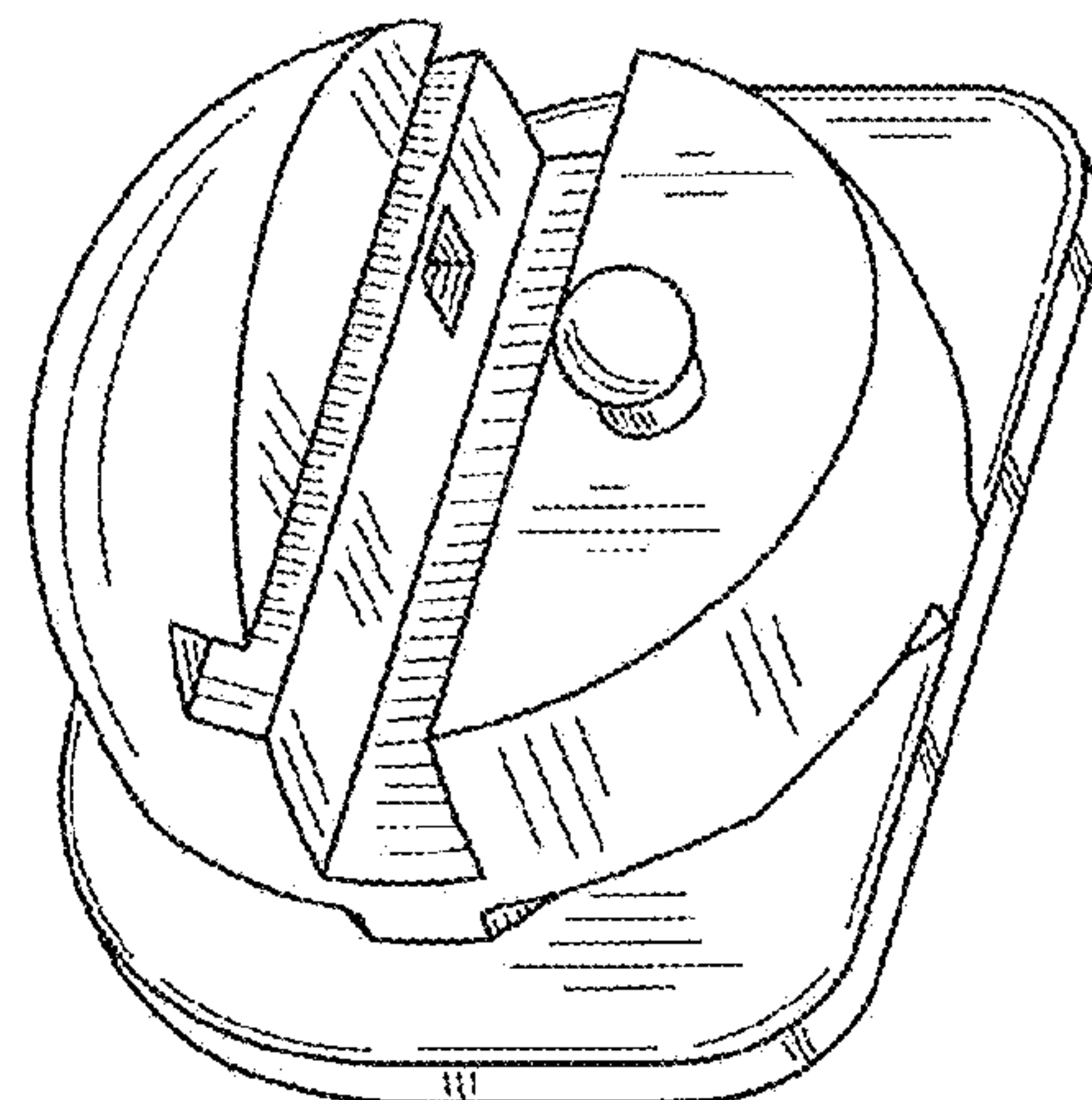
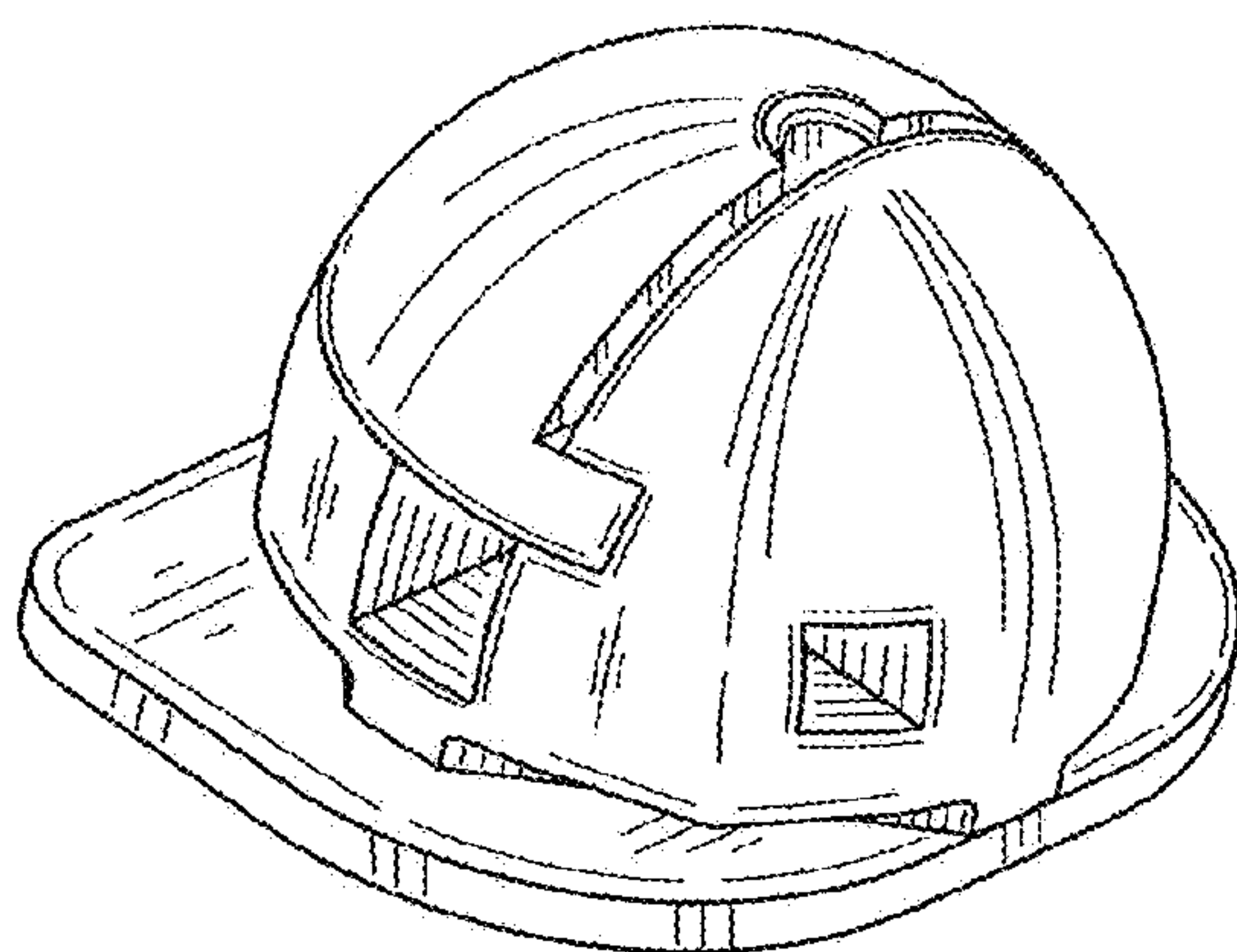

FIG. 23 is a rear view corresponding to FIG. 22;  
FIG. 24 is a left side view corresponding to FIG. 22;  
FIG. 25 is a right side view corresponding to FIG. 22;  
FIG. 26 is a top view corresponding to FIG. 22;  
FIG. 27 is a bottom view corresponding to FIG. 22;  
FIG. 28 is a perspective view corresponding to FIG. 22;  
FIG. 29 is a front view of another embodiment of the orthodontic bracket with a bottom component and a cover fully assembled together showing my new design, the difference between this embodiment and the embodiment of FIGS. 1-28 being a matter of dimension in accordance with the size of the tooth;  
FIG. 30 is a rear view corresponding to FIG. 29;  
FIG. 31 is a left side view corresponding to FIG. 29;  
FIG. 32 is a right side view corresponding to FIG. 29;  
FIG. 33 is a top view corresponding to FIG. 29;  
FIG. 34 is a bottom view corresponding to FIG. 29;  
FIG. 35 is a perspective view corresponding to FIG. 29;  
FIG. 36 is a front view of the bottom component of FIG. 29 shown separately for ease of illustration;  
FIG. 37 is a rear view corresponding to FIG. 36;  
FIG. 38 is a left side view corresponding to FIG. 36;

FIG. 39 is a right side view corresponding to FIG. 36;  
FIG. 40 is a top view corresponding to FIG. 36;  
FIG. 41 is a bottom view corresponding to FIG. 36;  
FIG. 42 is a perspective view corresponding to FIG. 36;  
FIG. 43 is a front view of the cover portion of FIG. 29 shown separately for ease of illustration;  
FIG. 44 is a rear view corresponding to FIG. 43;  
FIG. 45 is a left side view corresponding to FIG. 43;  
FIG. 46 is a right side view corresponding to FIG. 43;  
FIG. 47 is a top view corresponding to FIG. 43;  
FIG. 48 is a bottom view corresponding to FIG. 43;  
FIG. 49 is a perspective view corresponding to FIG. 43;  
FIG. 50 is a front view of the orthodontic bracket showing the cover is in an opened position during assembly;  
FIG. 51 is a rear view corresponding to FIG. 50;  
FIG. 52 is a left side view corresponding to FIG. 50;  
FIG. 53 is a right side view corresponding to FIG. 50;  
FIG. 54 is a top view corresponding to FIG. 50;  
FIG. 55 is a bottom view corresponding to FIG. 50; and,  
FIG. 56 is a perspective view corresponding to FIG. 50.

**1 Claim, 8 Drawing Sheets**



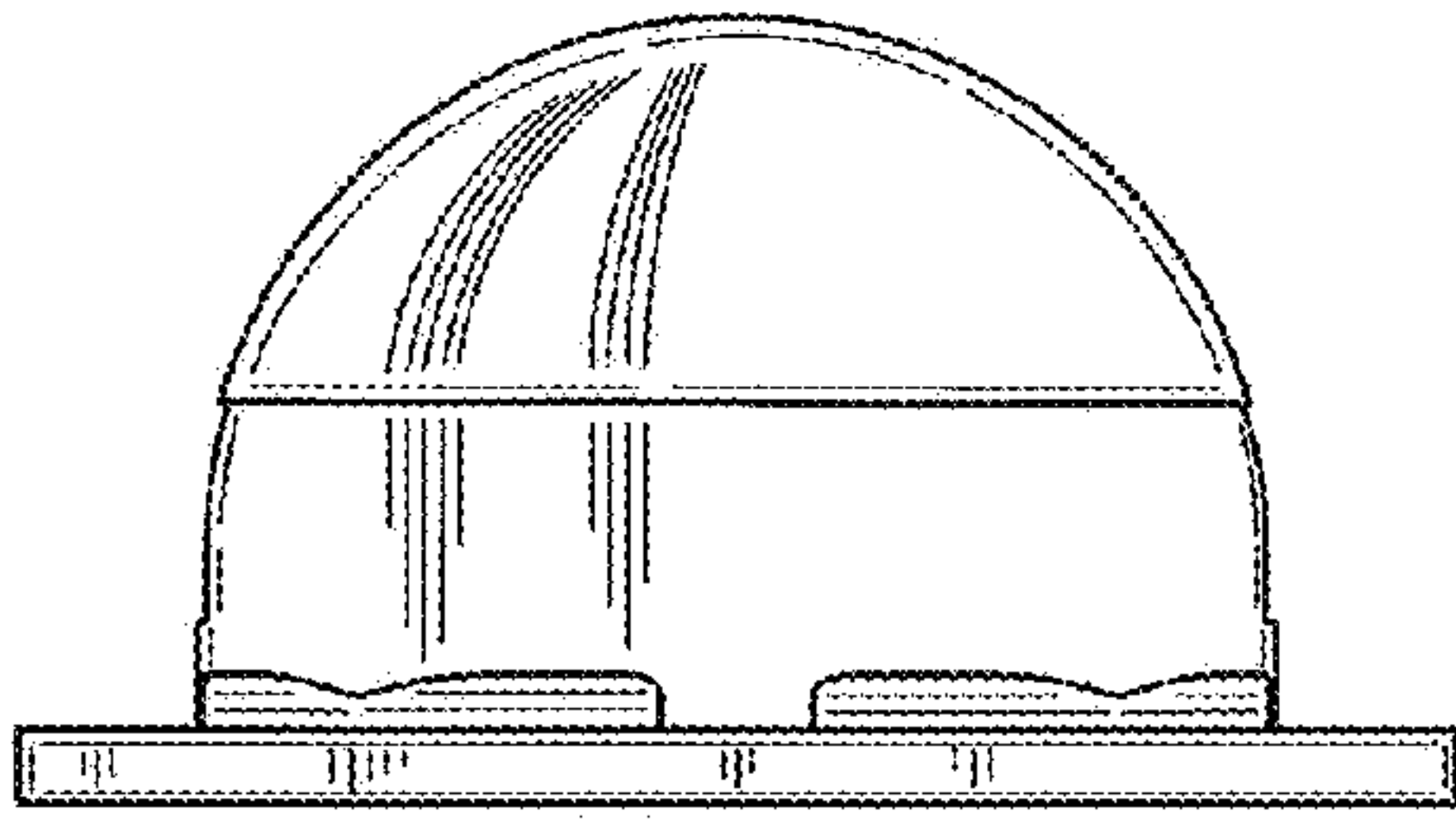

FIG. 1

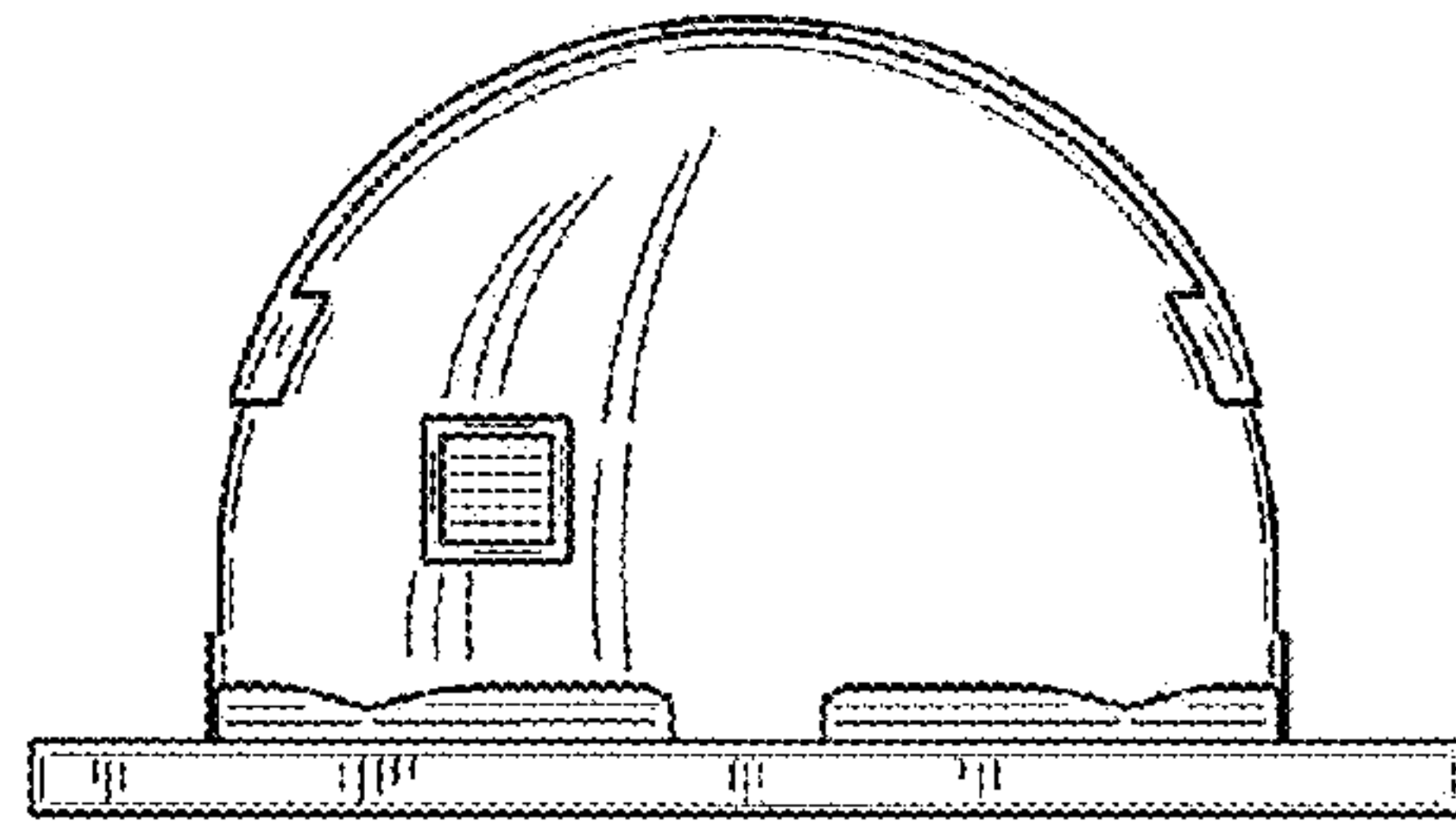

FIG. 2

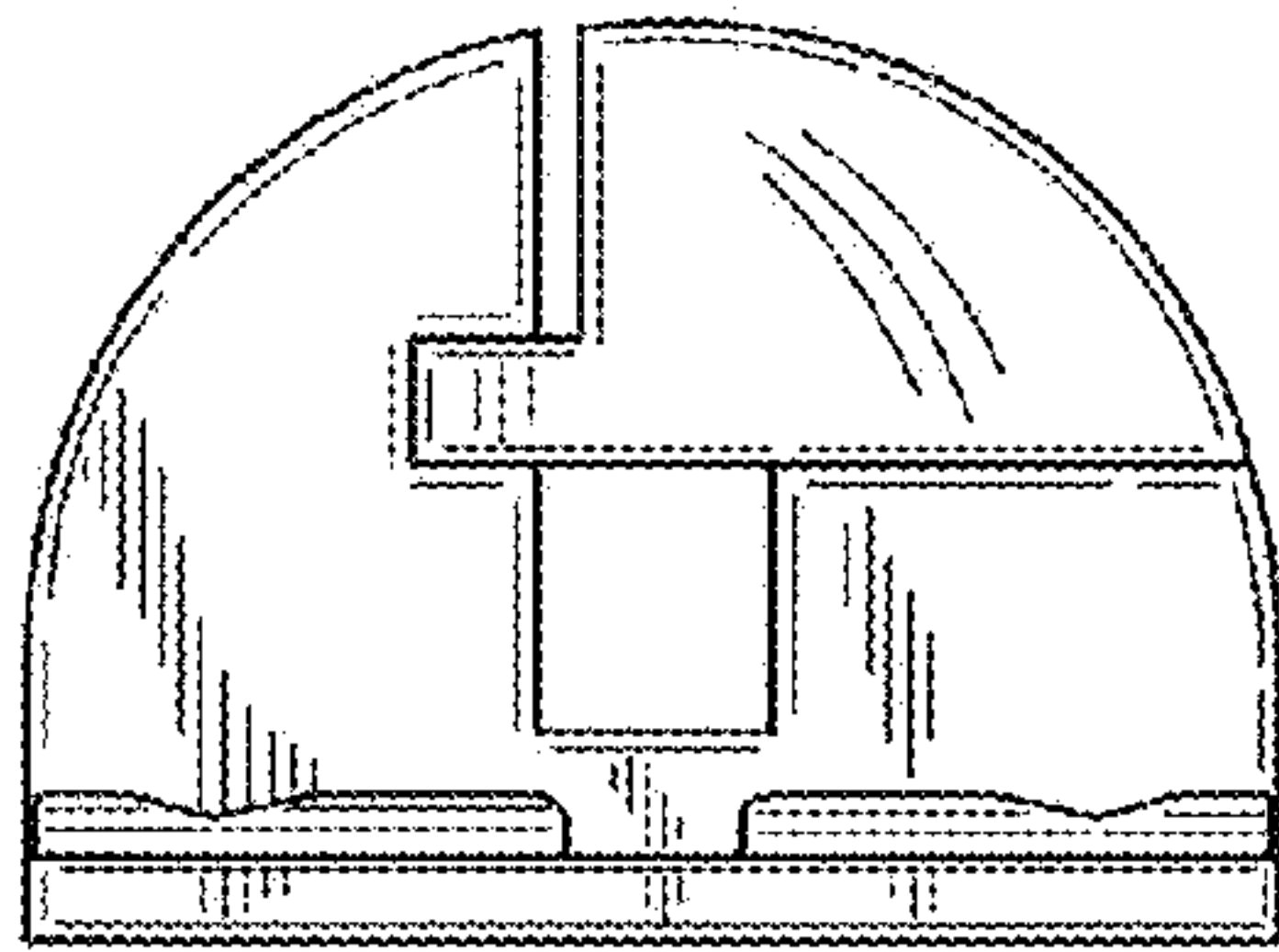

FIG. 3

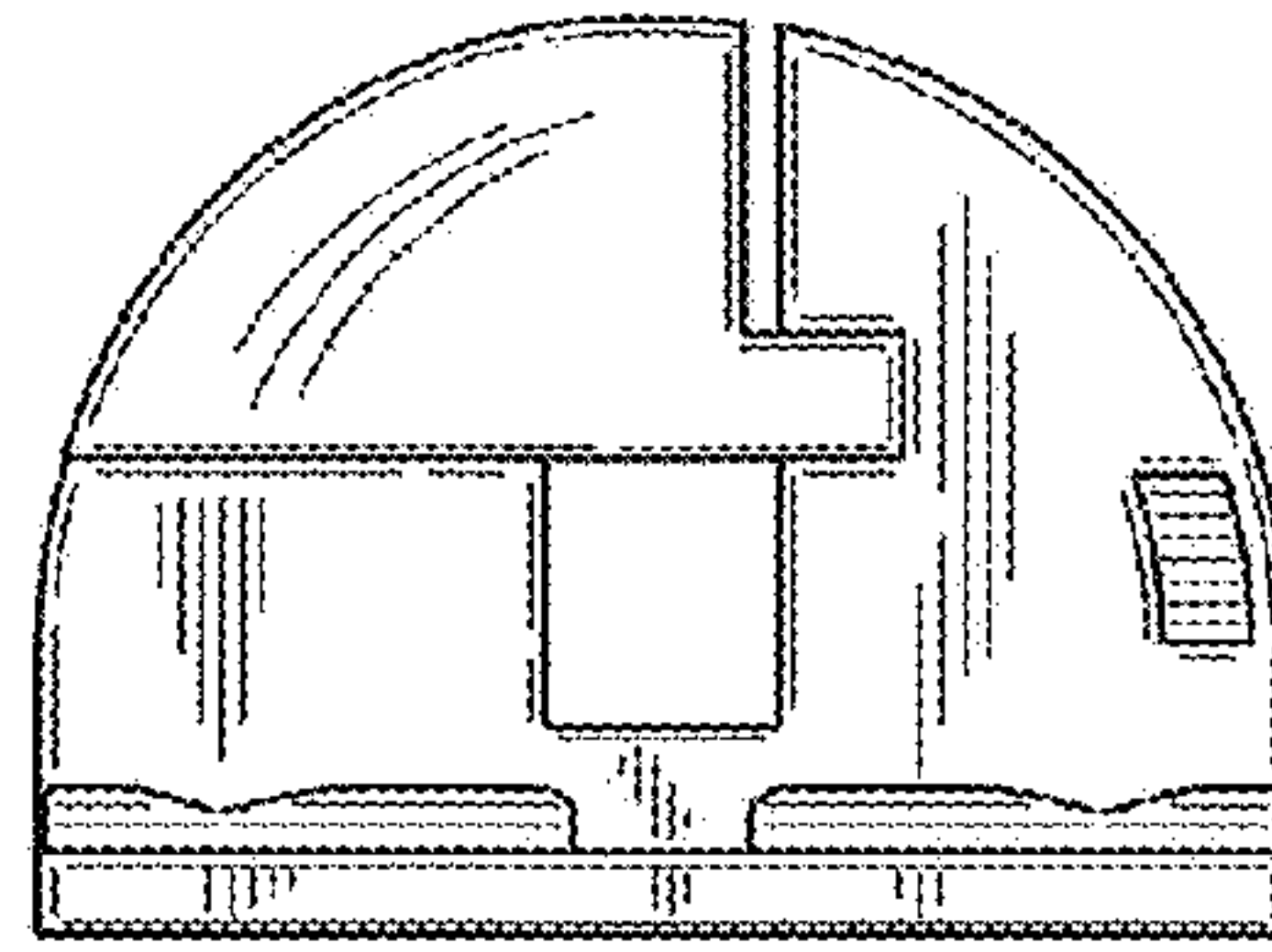

FIG. 4

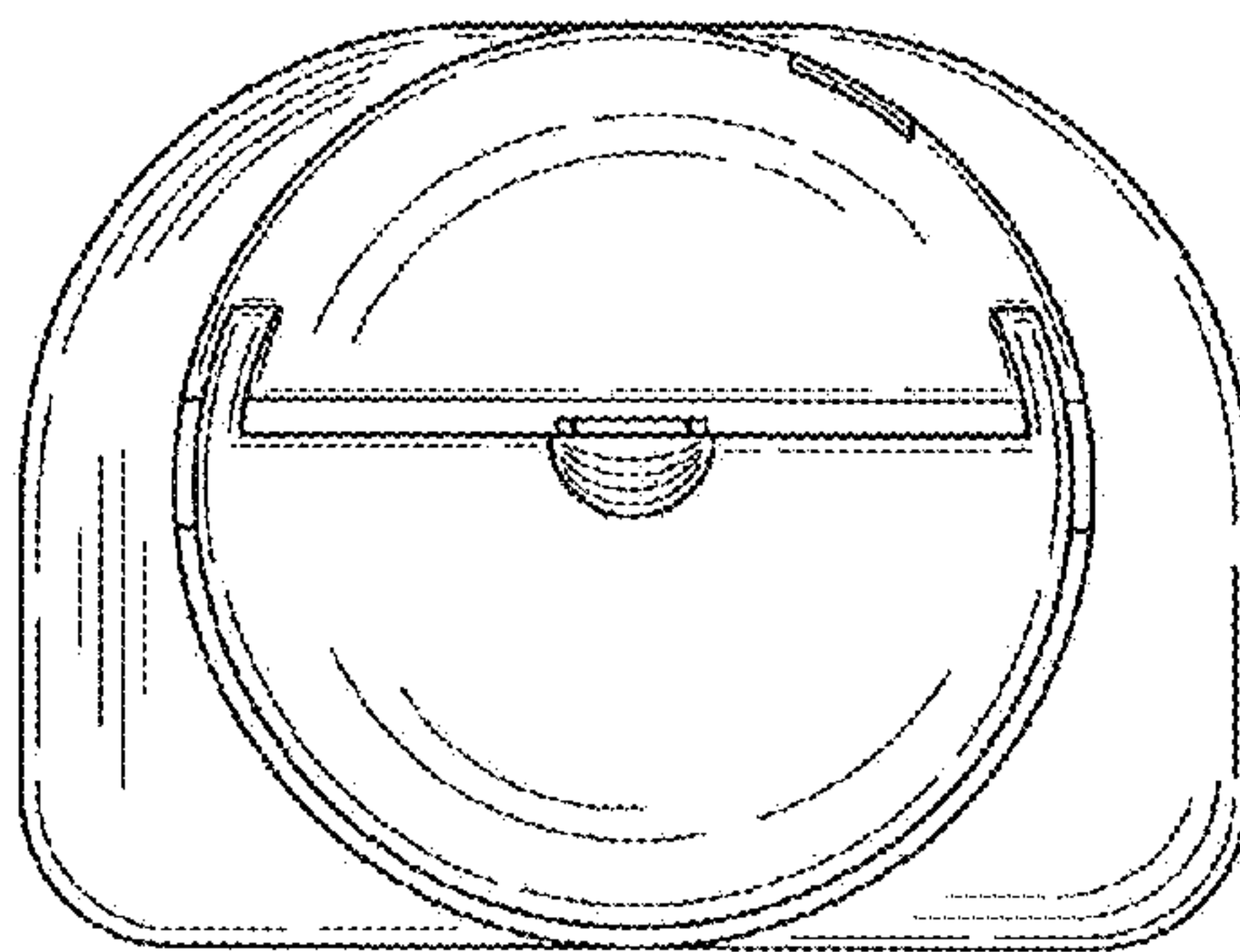

FIG. 5

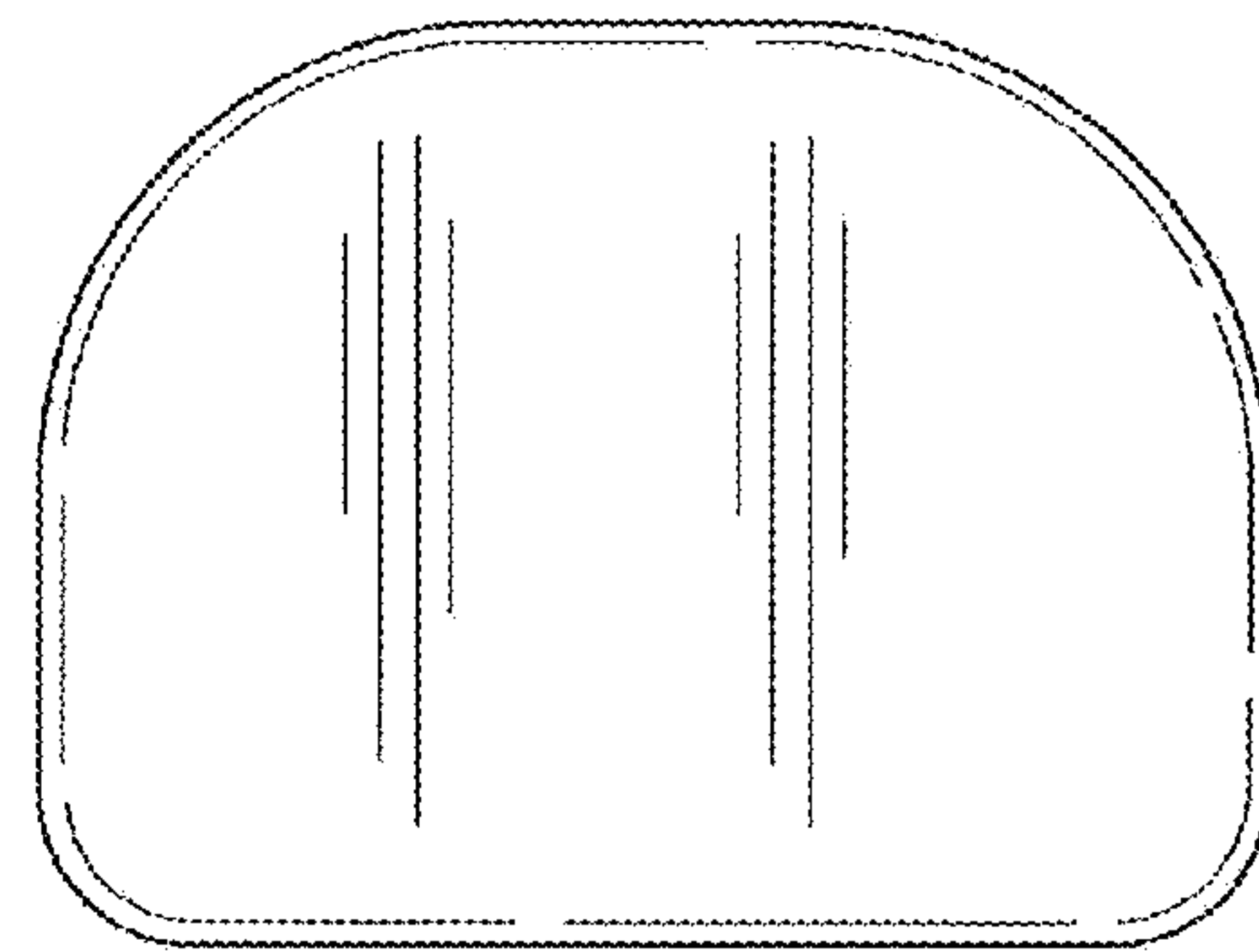

FIG. 6

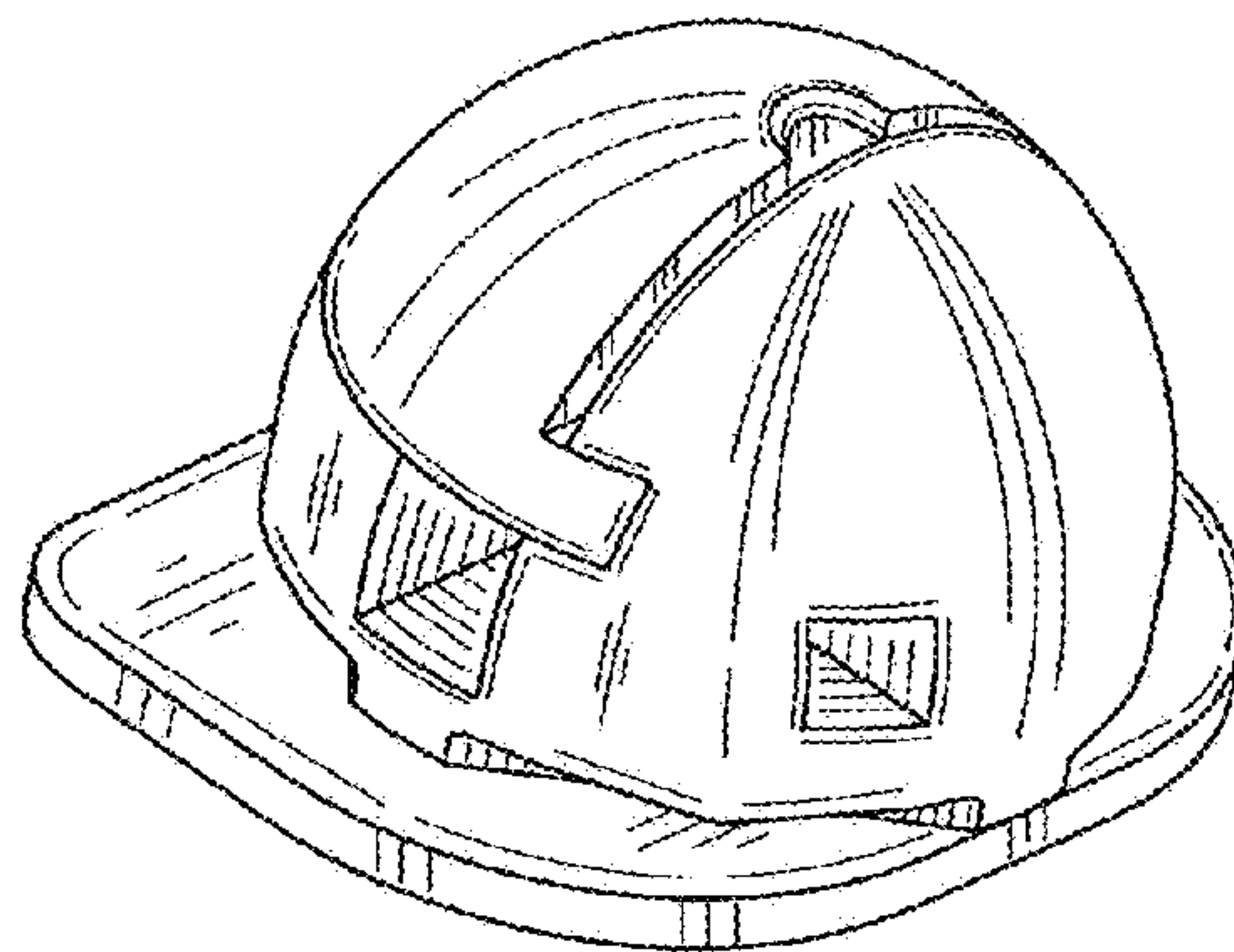

FIG. 7

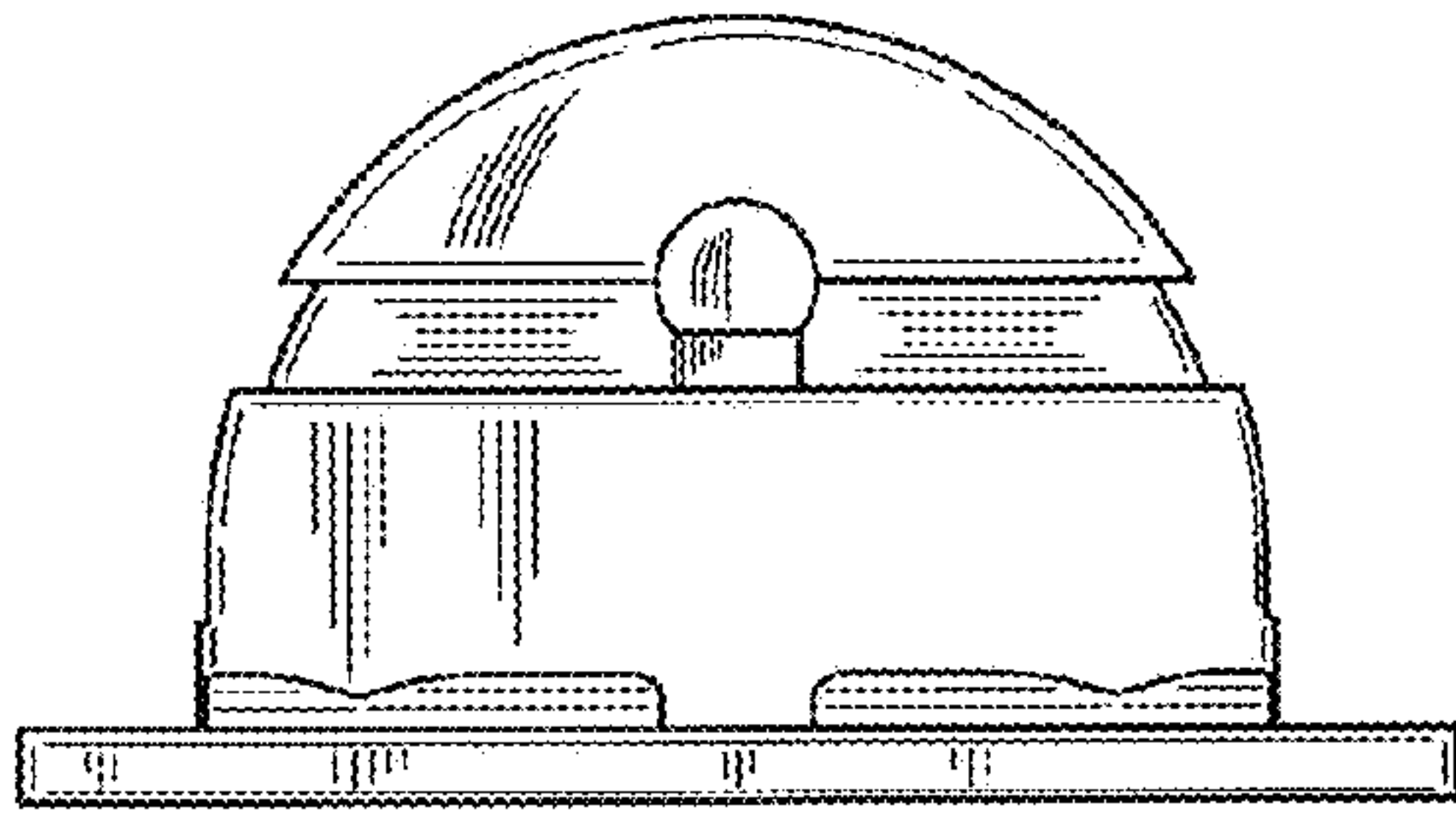

FIG. 8

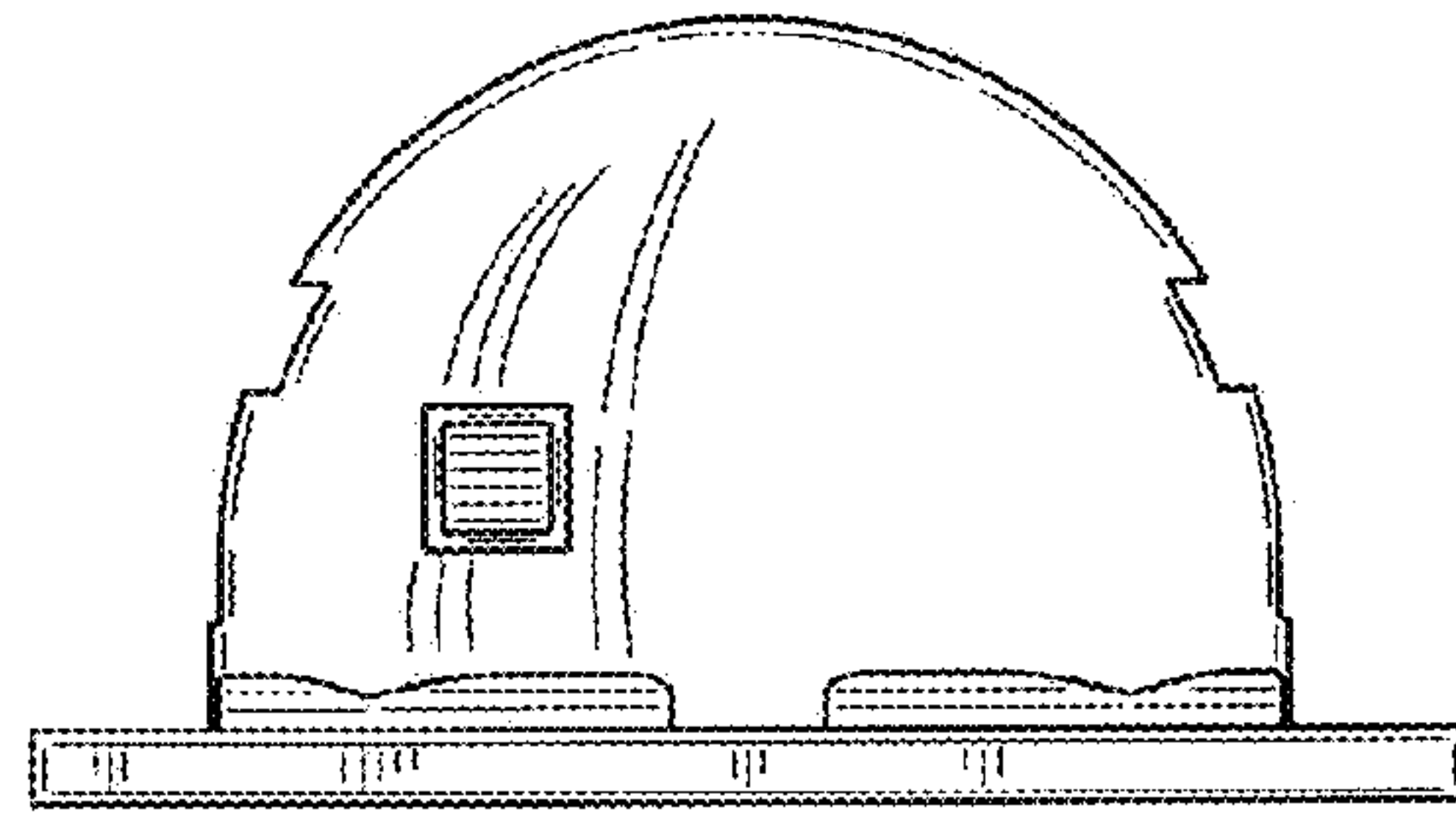

FIG. 9

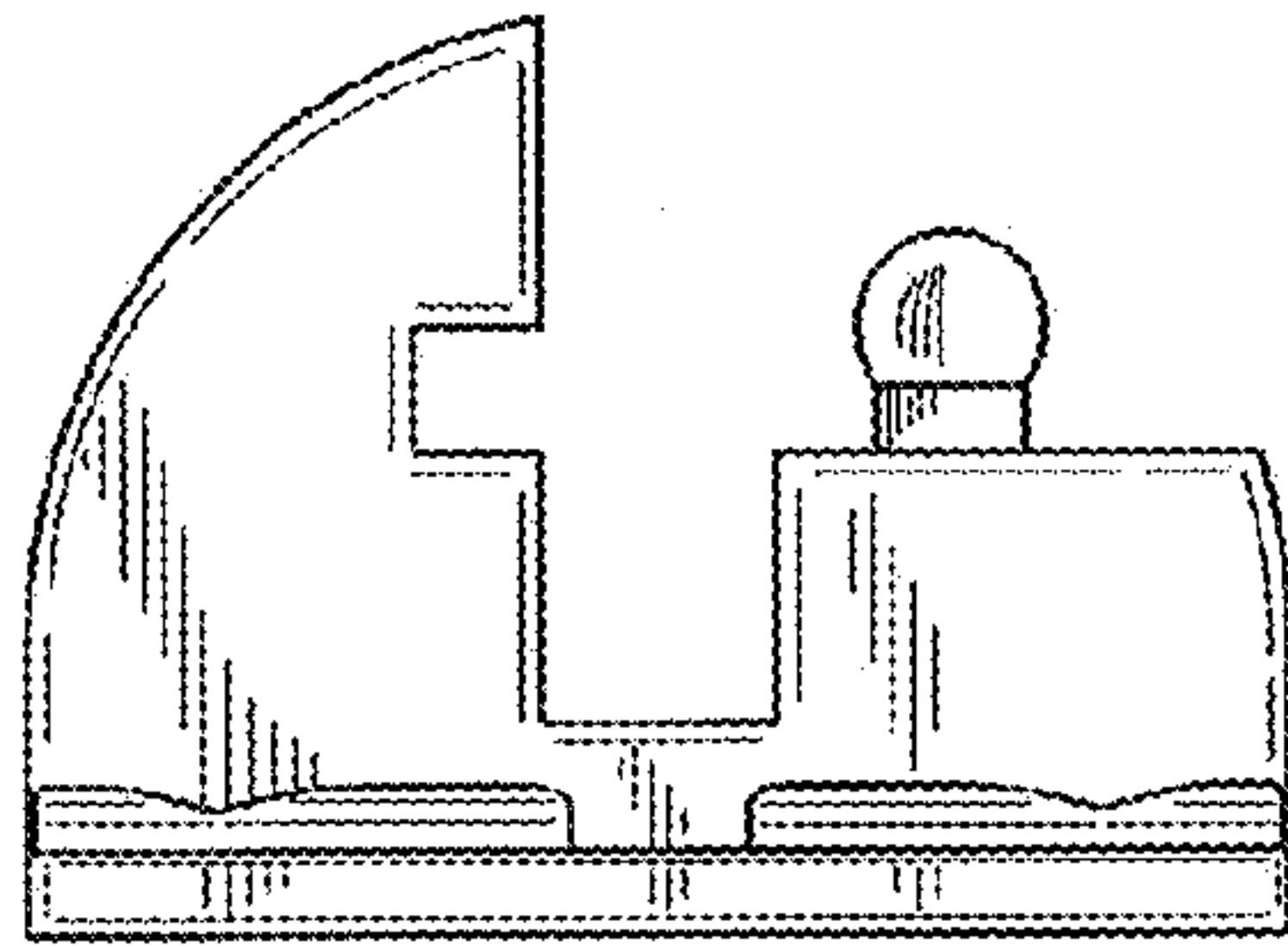

FIG. 10

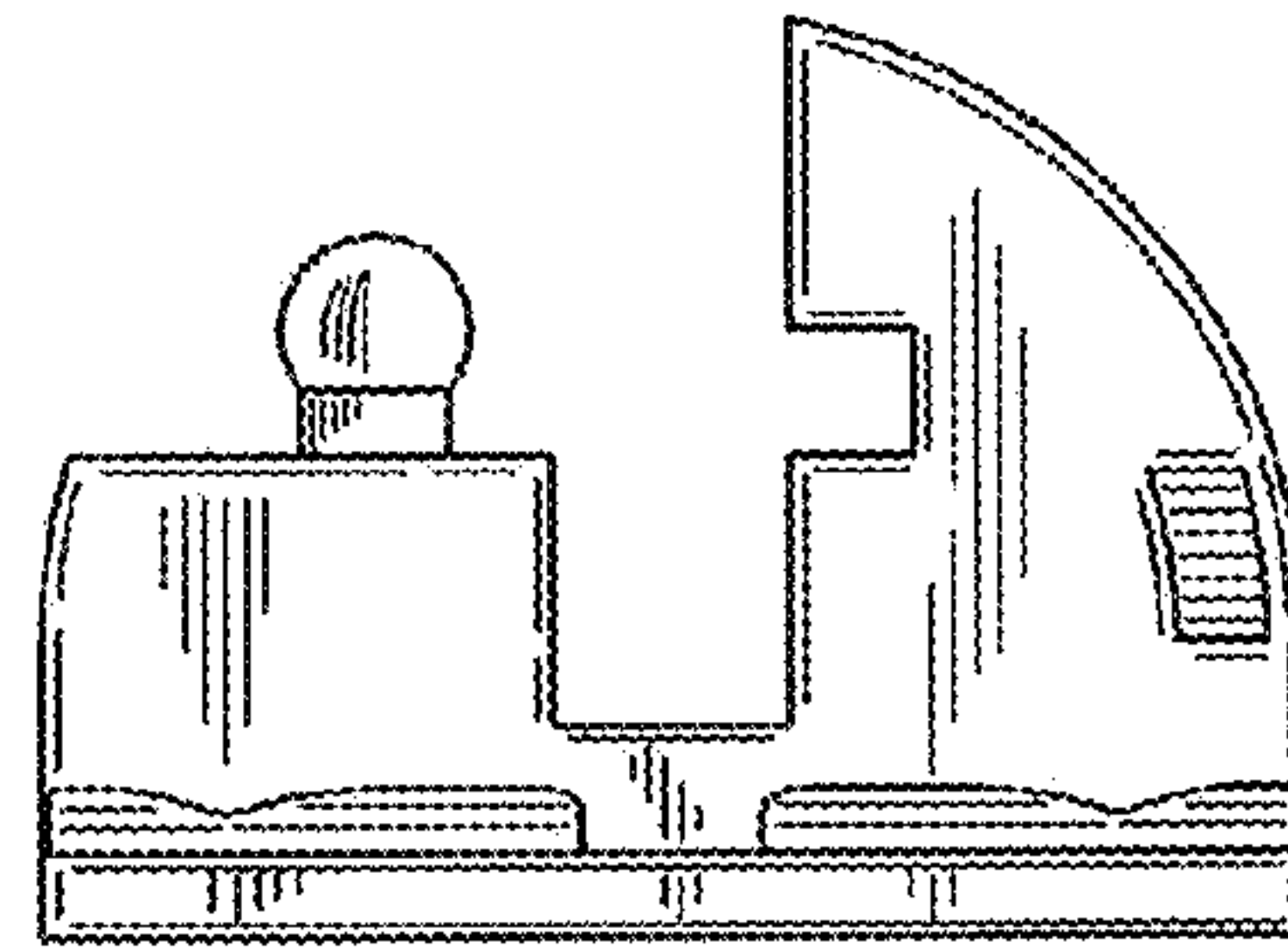

FIG. 11

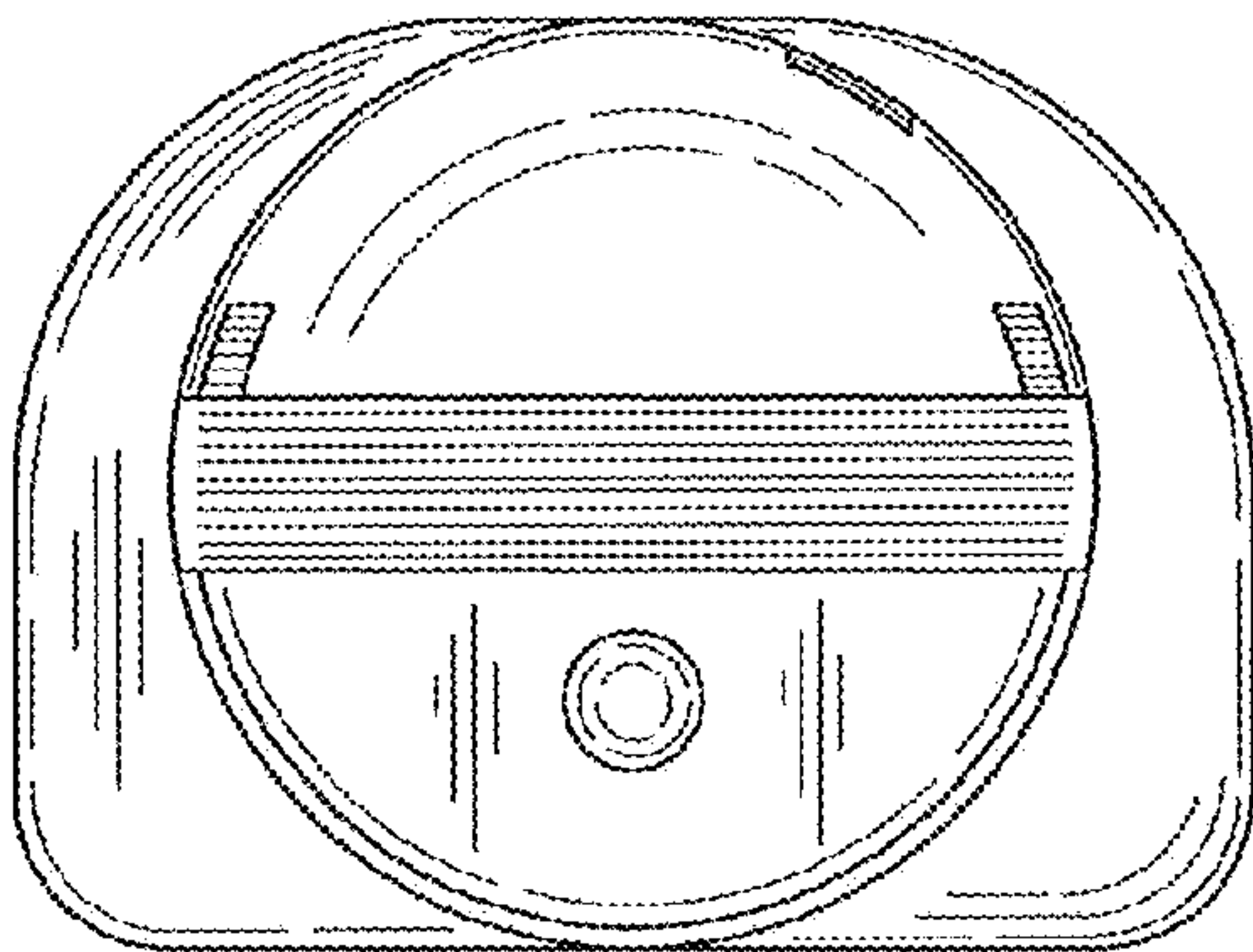

FIG. 12

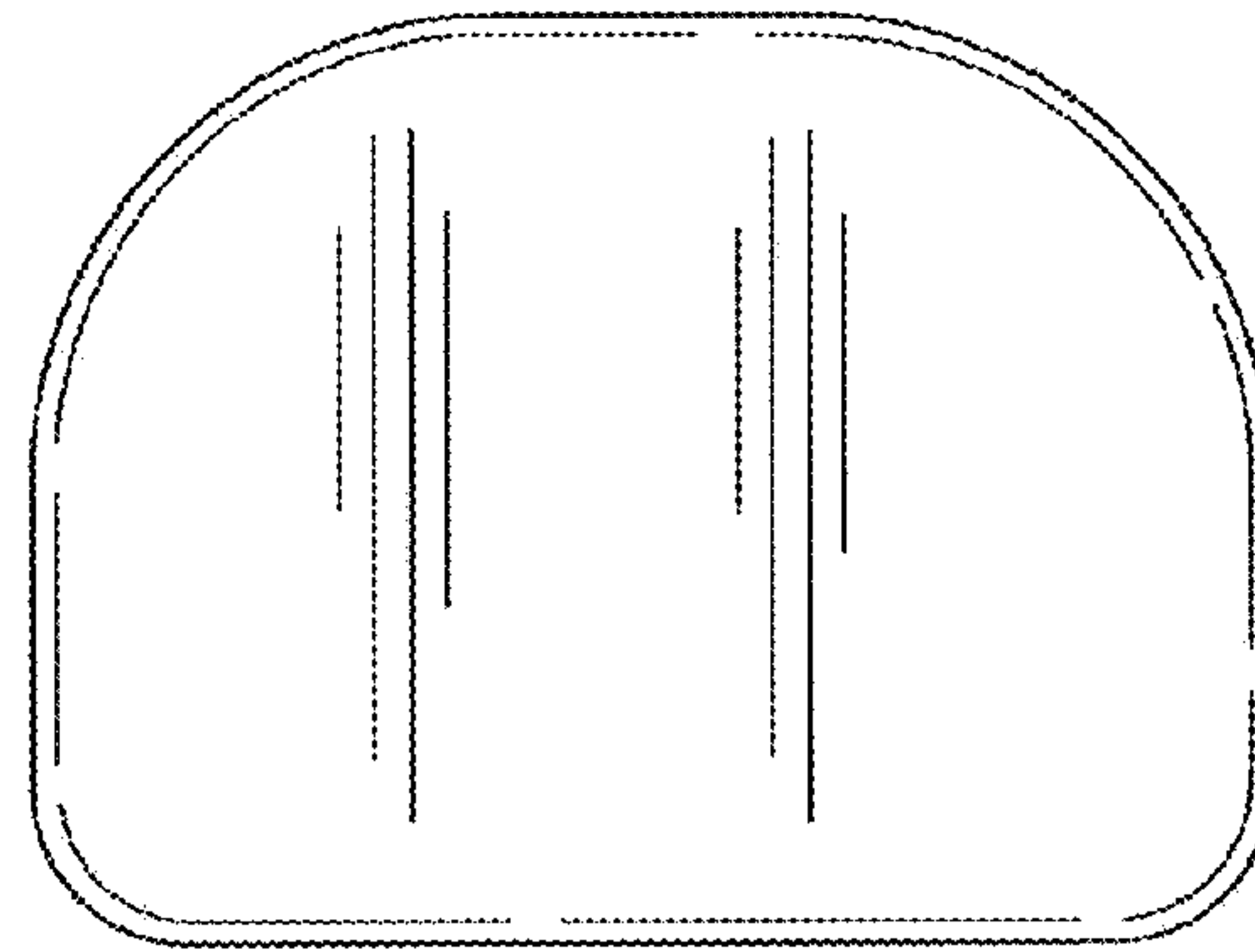

FIG. 13

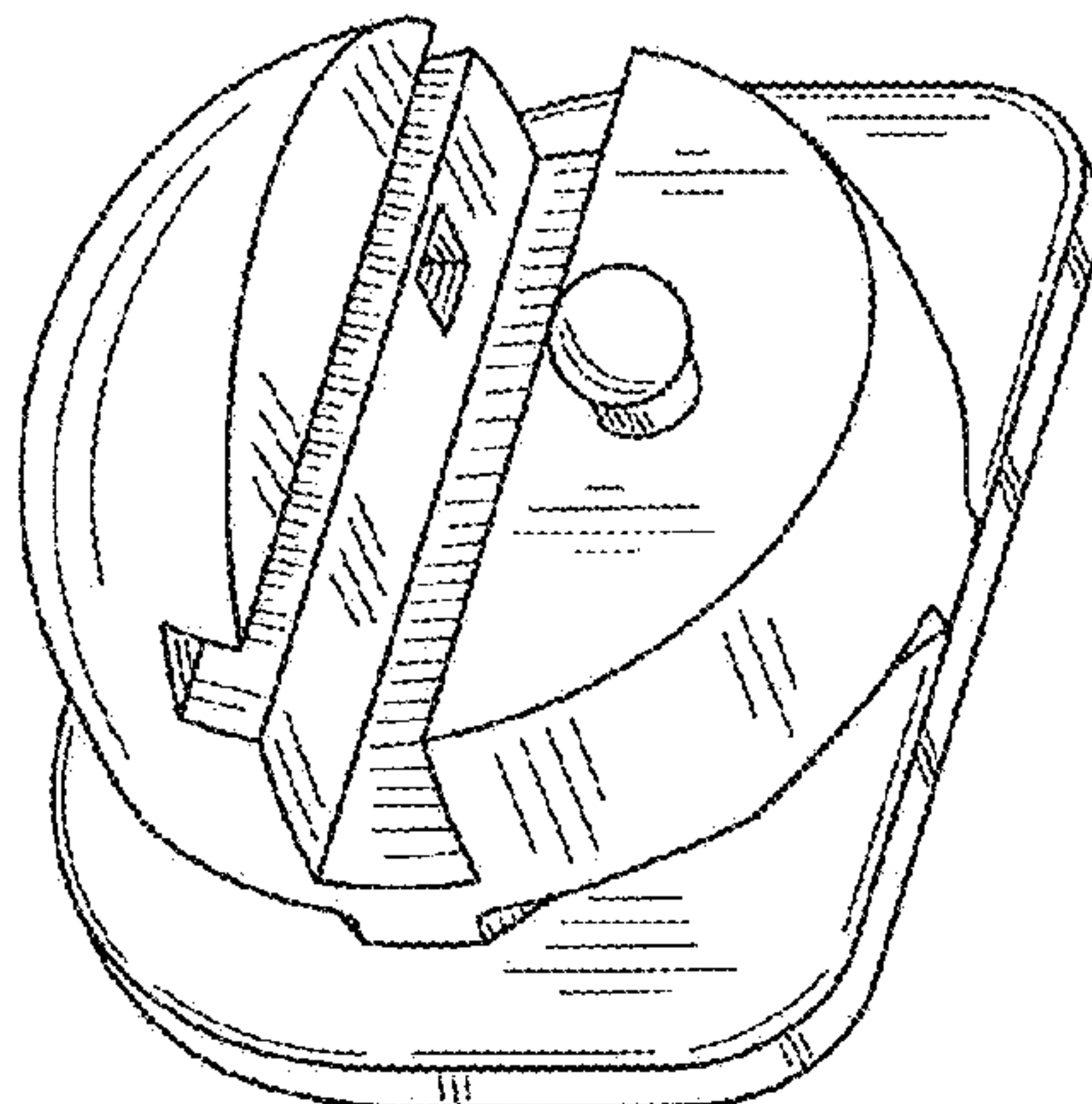

FIG. 14

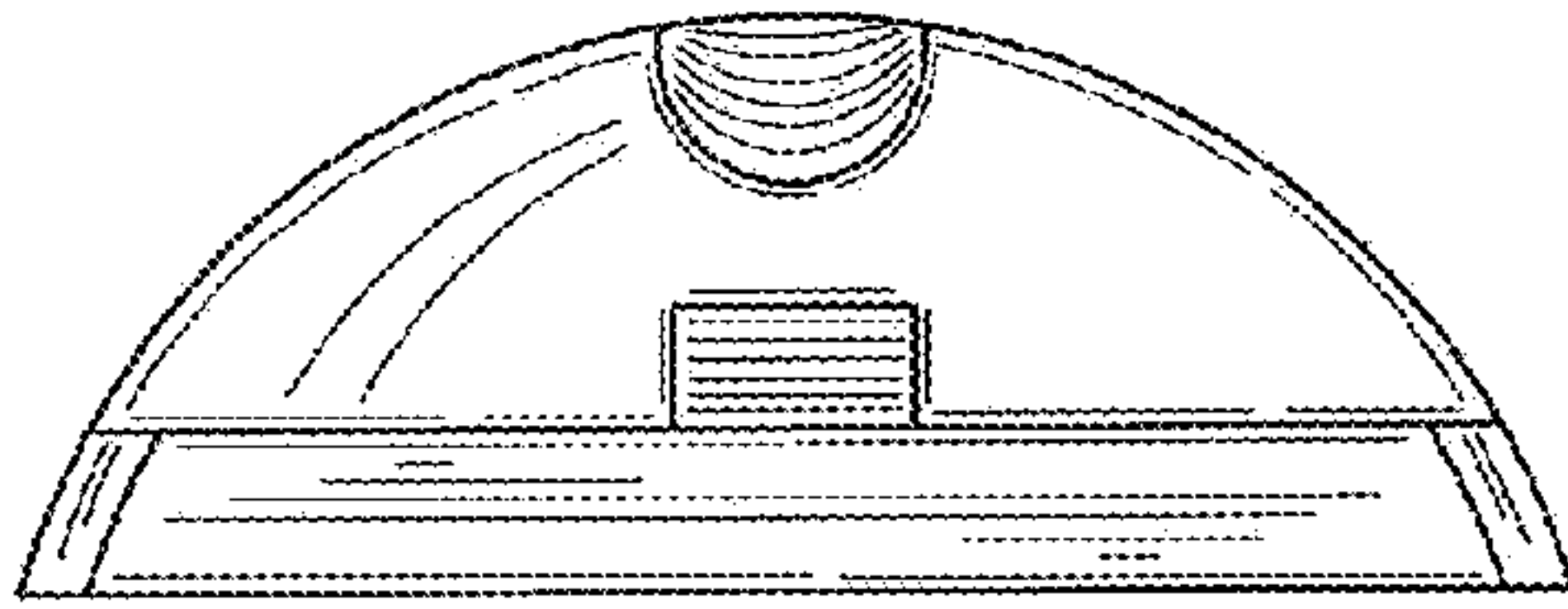

FIG. 15

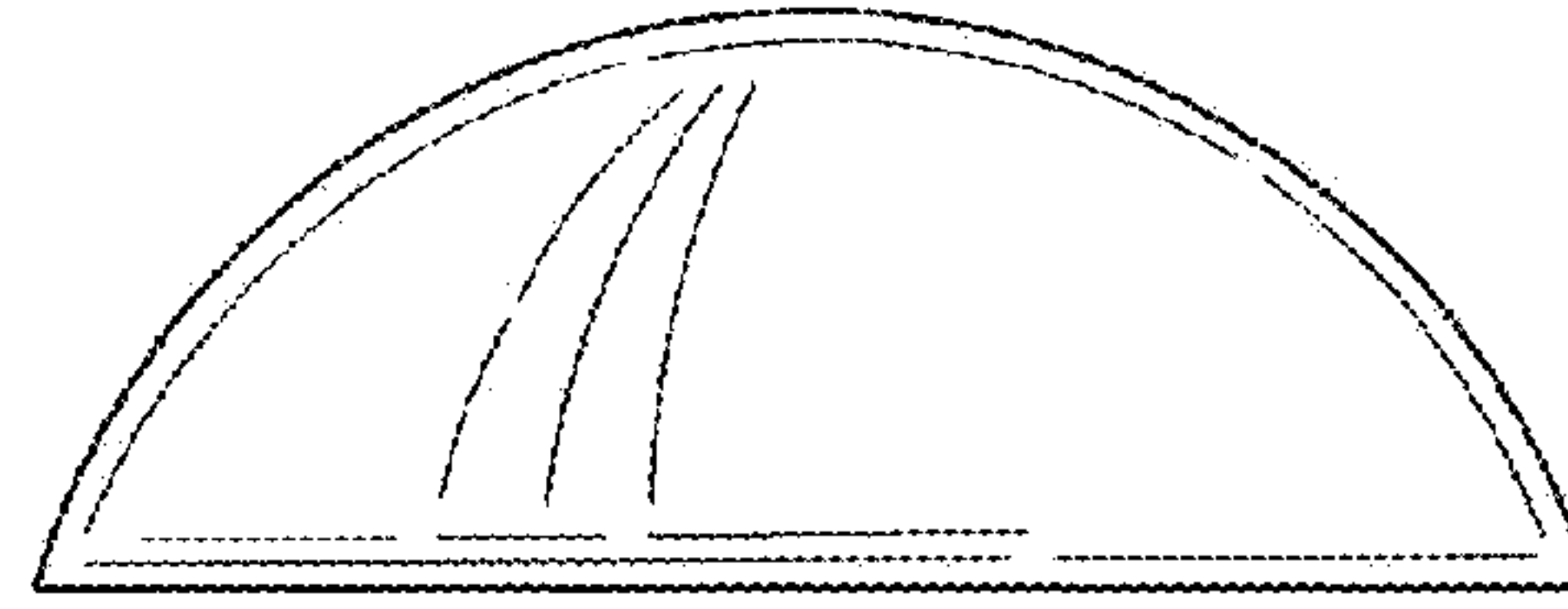

FIG. 16

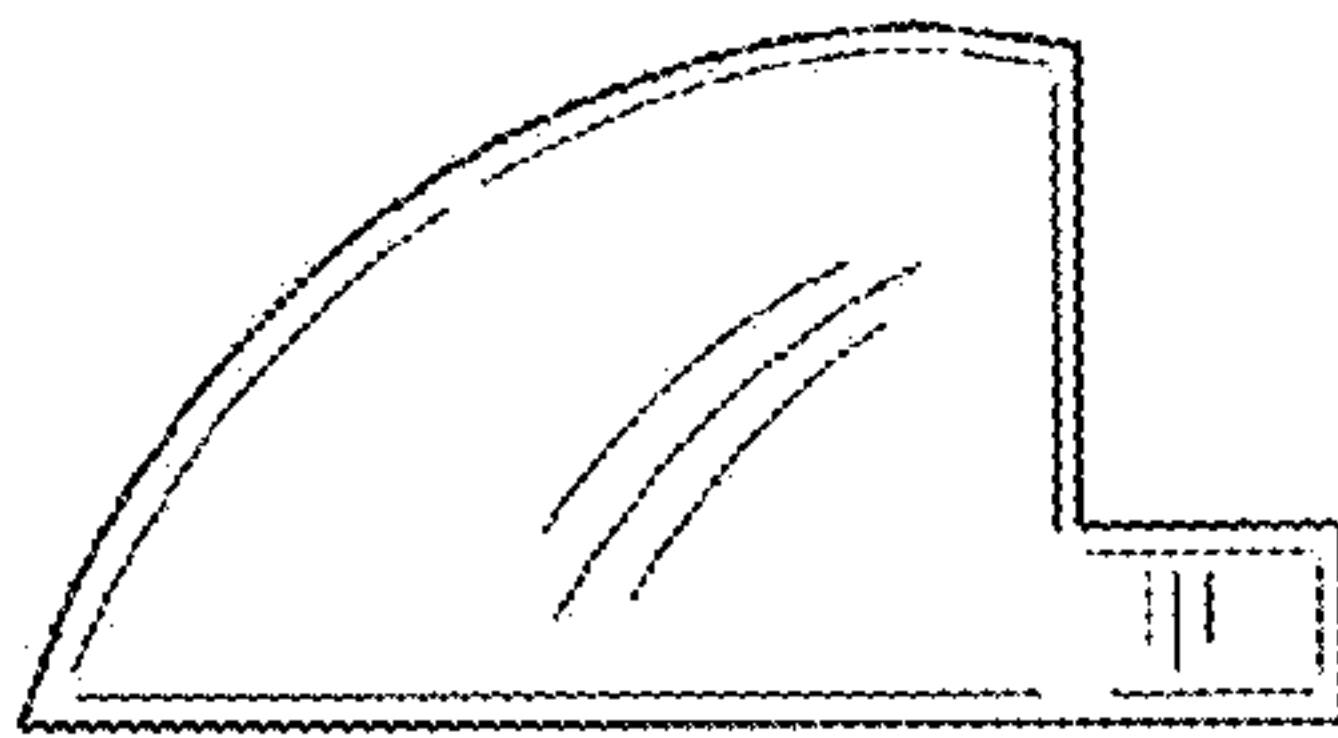

FIG. 17

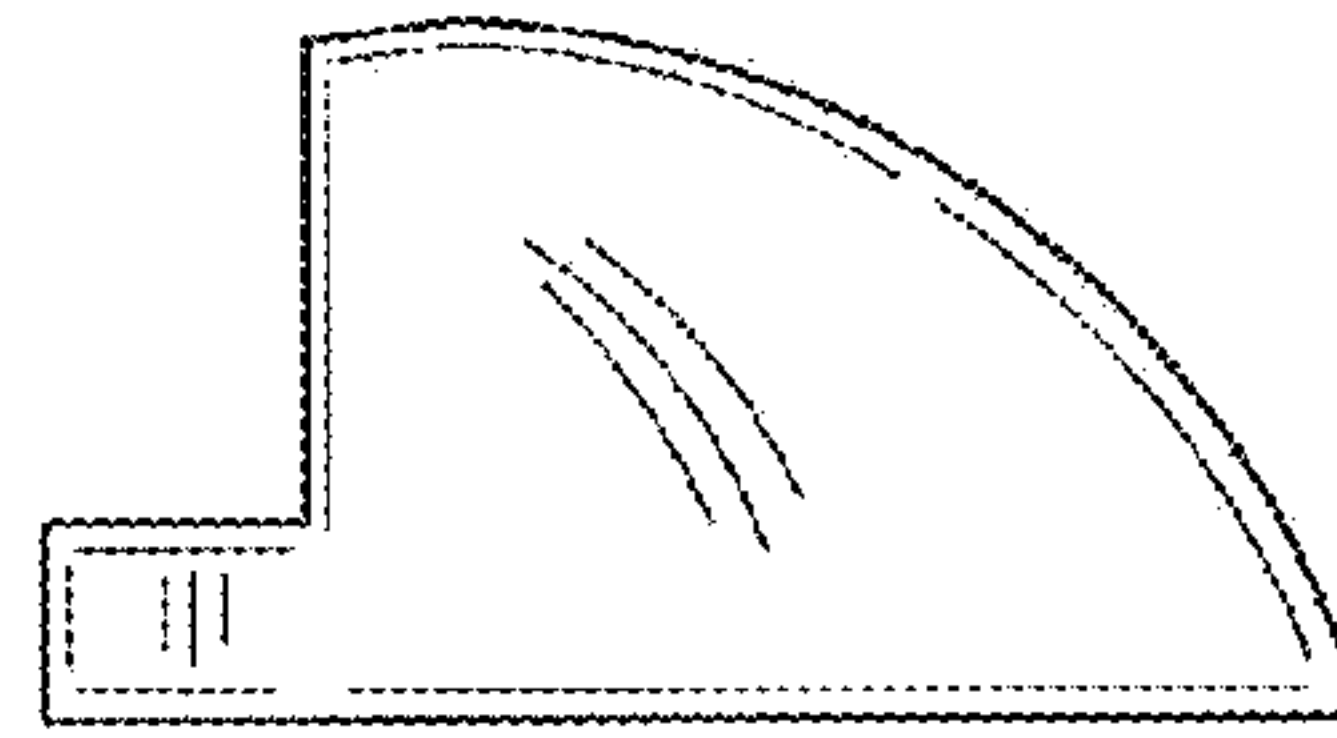

FIG. 18

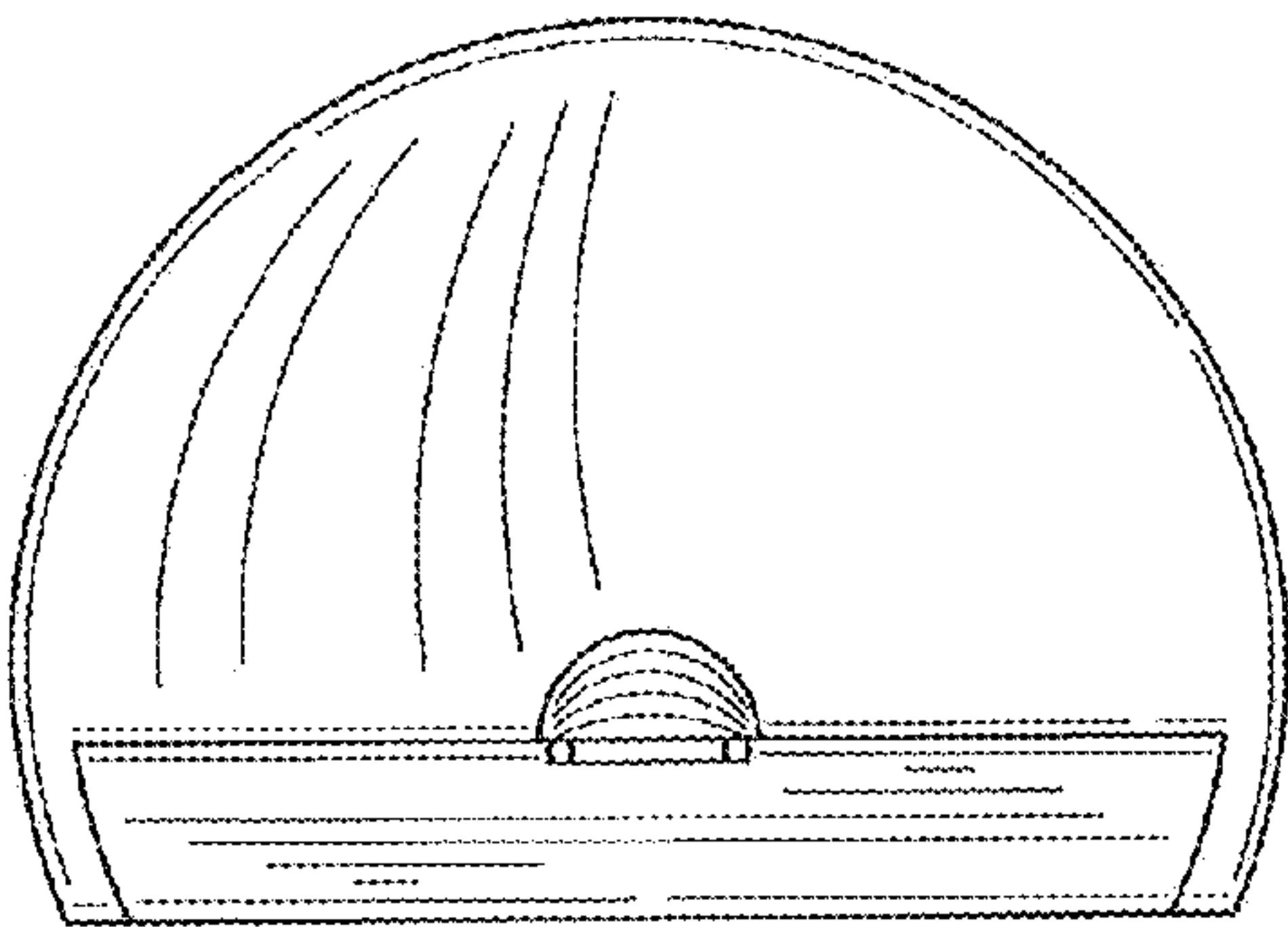

FIG. 19

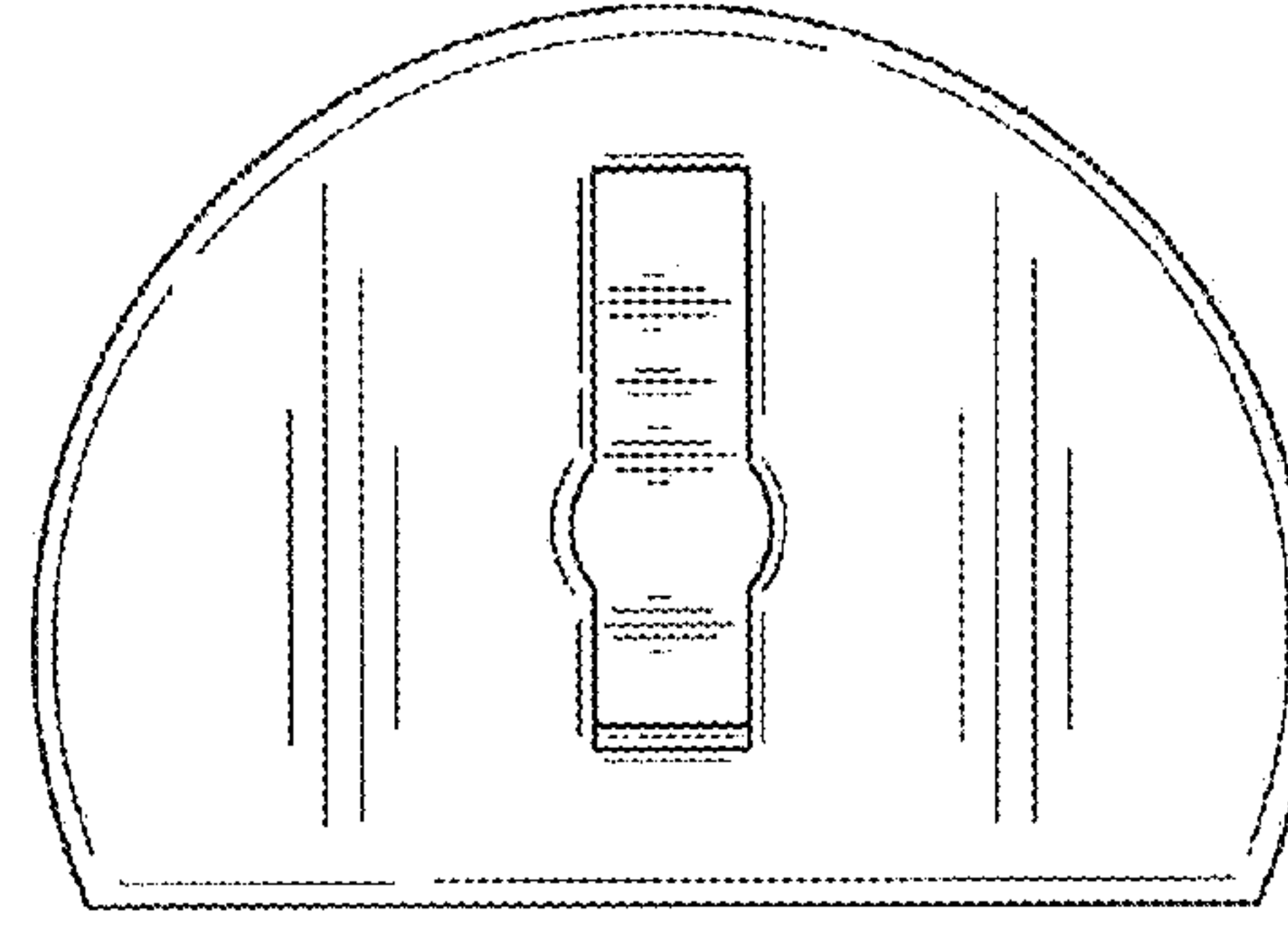

FIG. 20

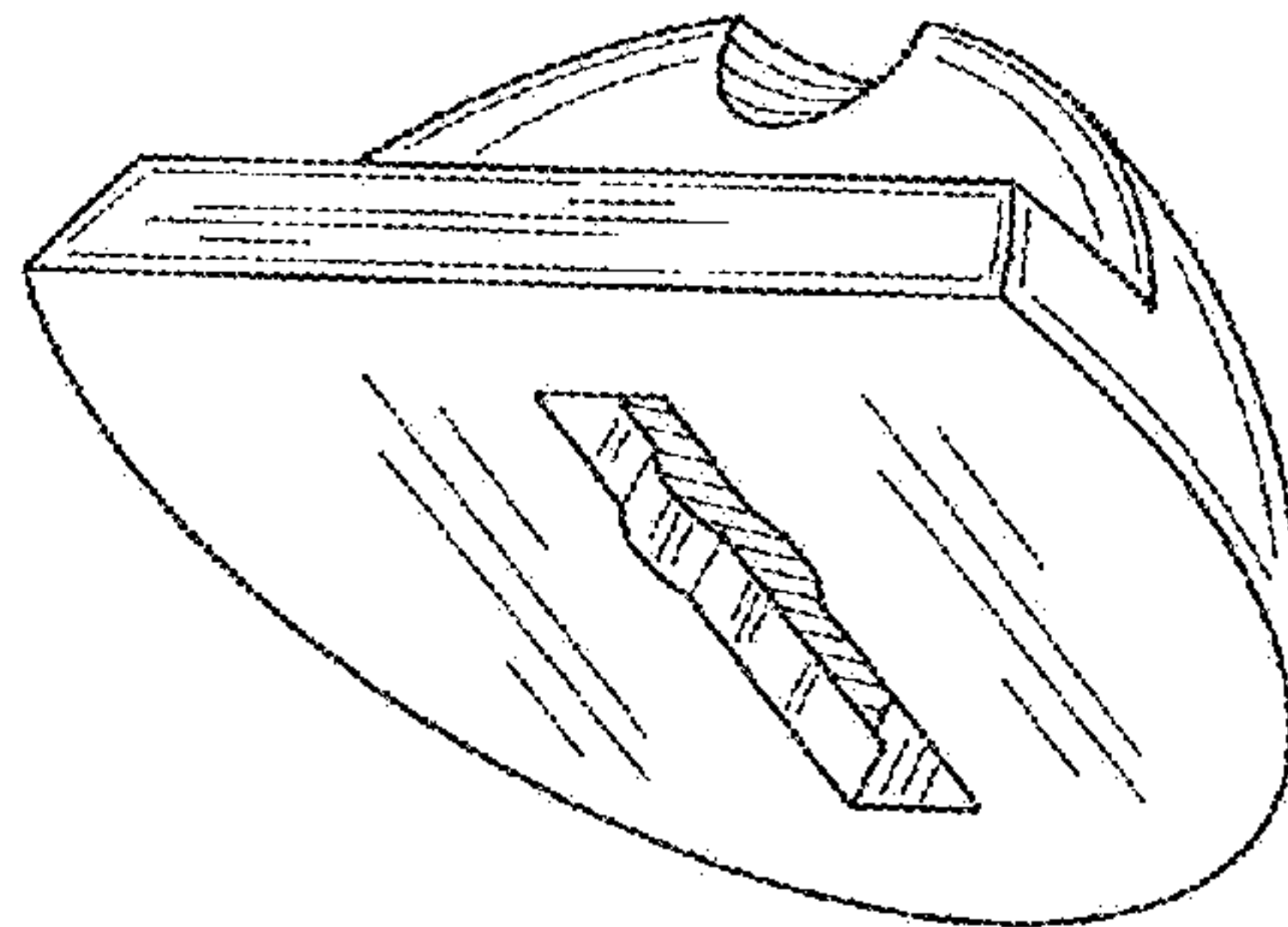

FIG. 21



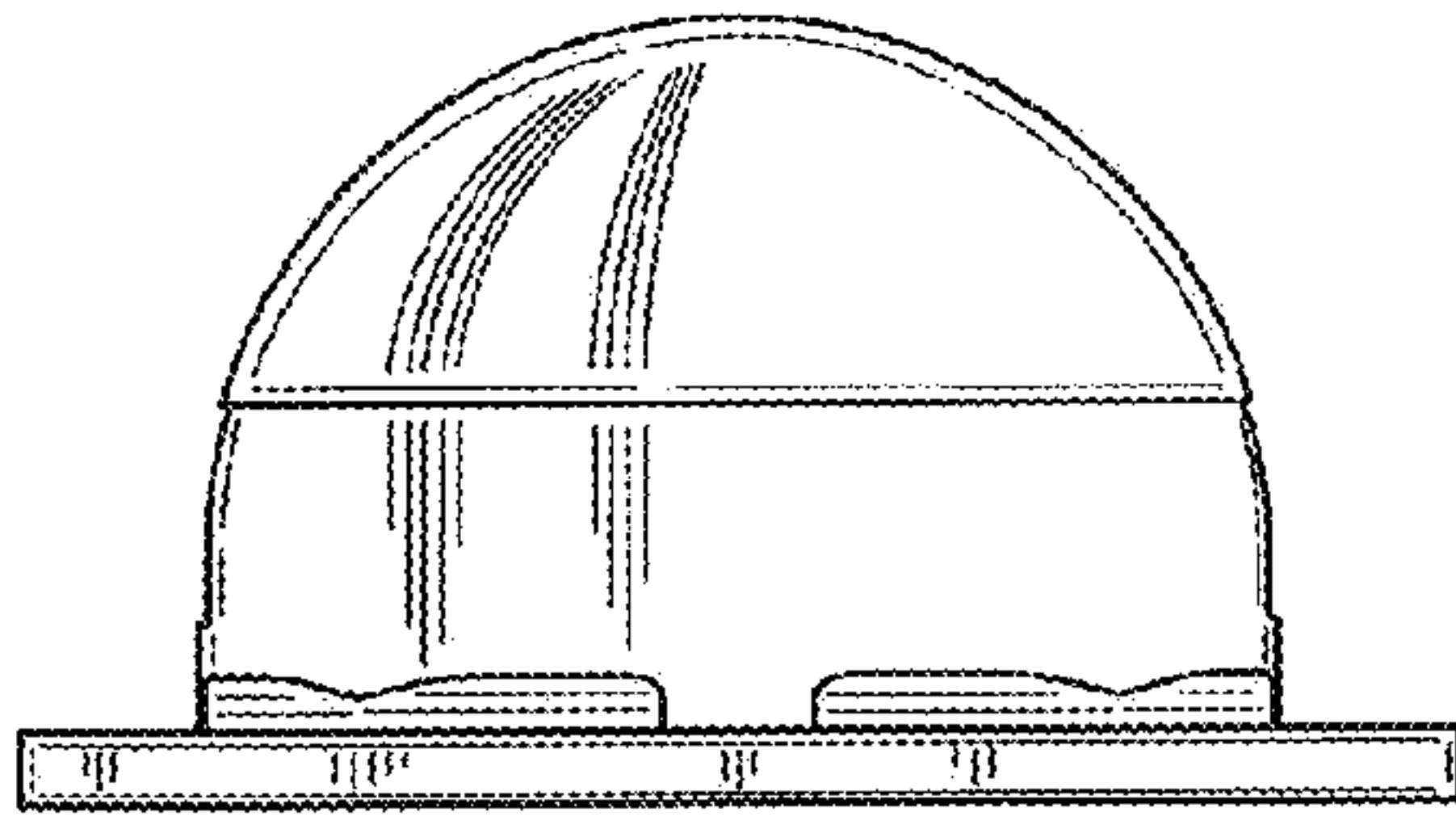

FIG. 22

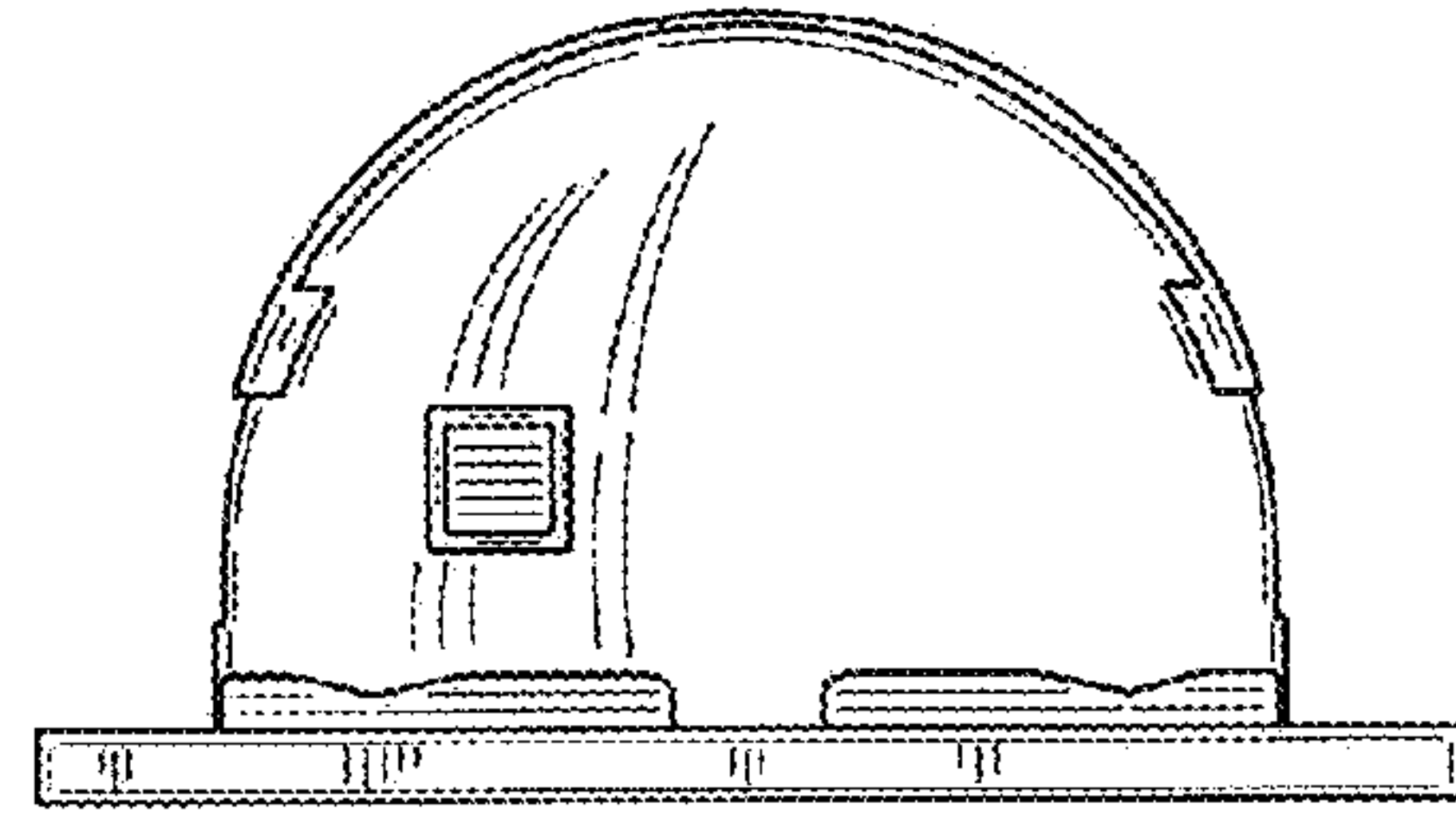

FIG. 23

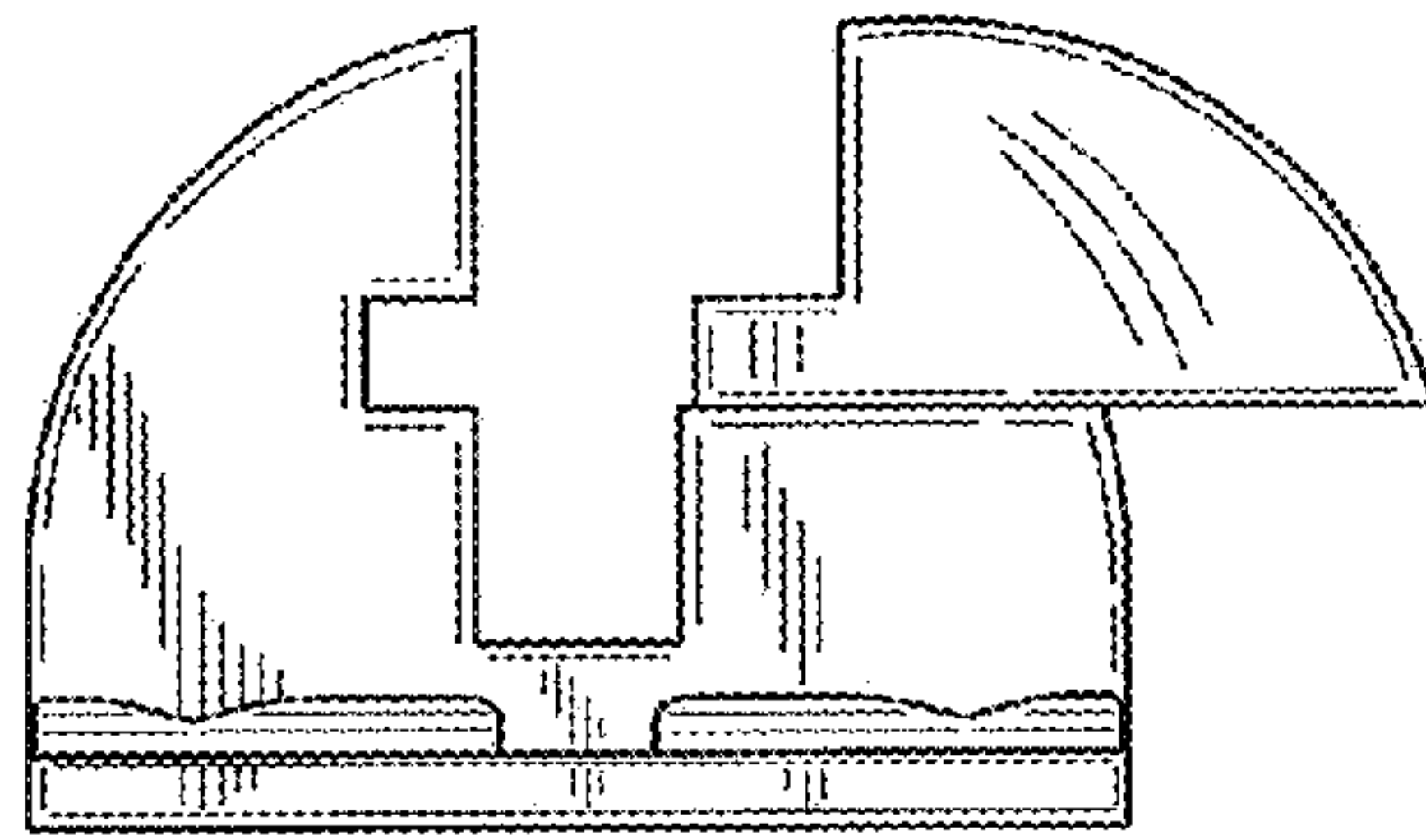

FIG. 24

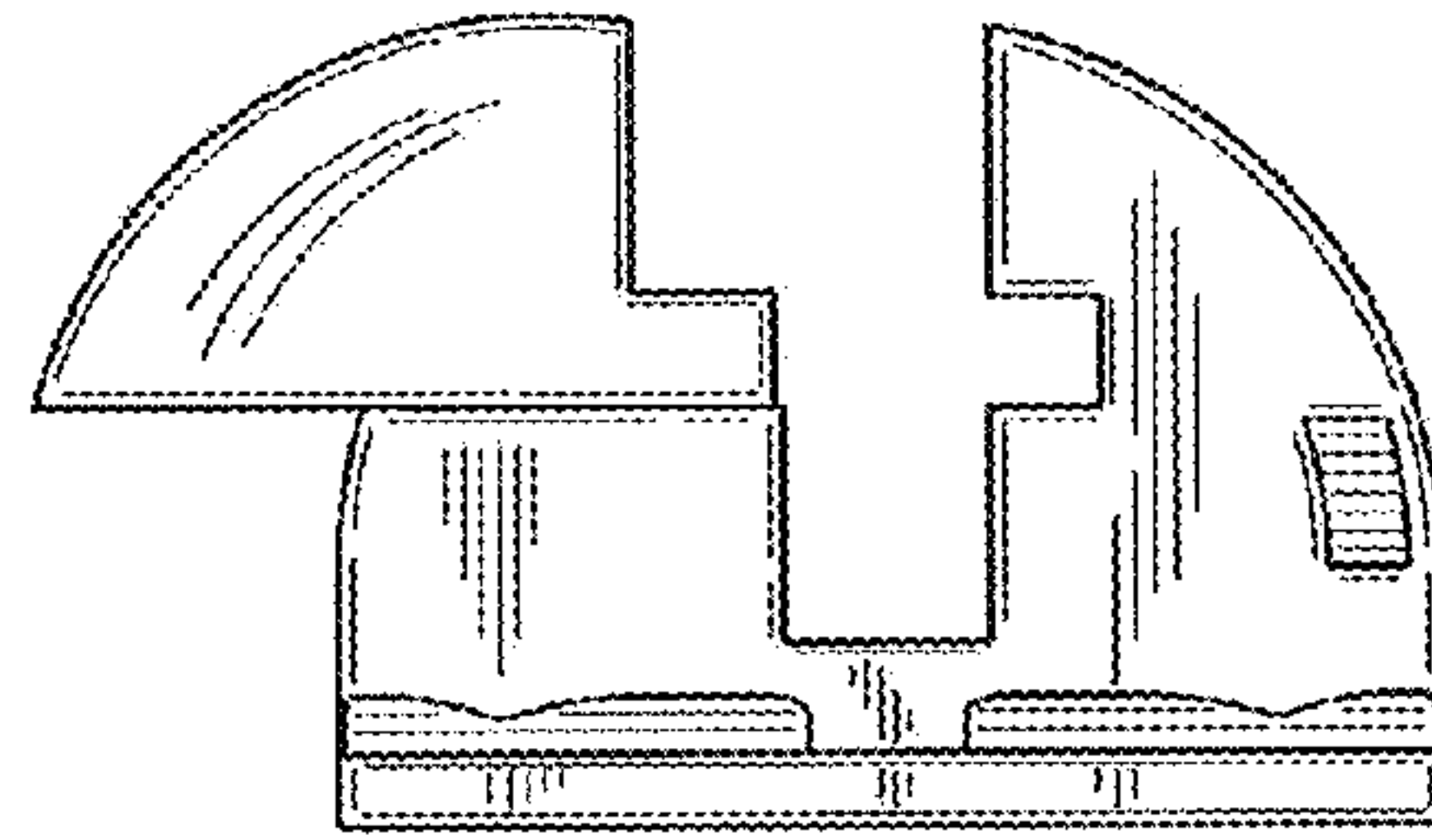

FIG. 25

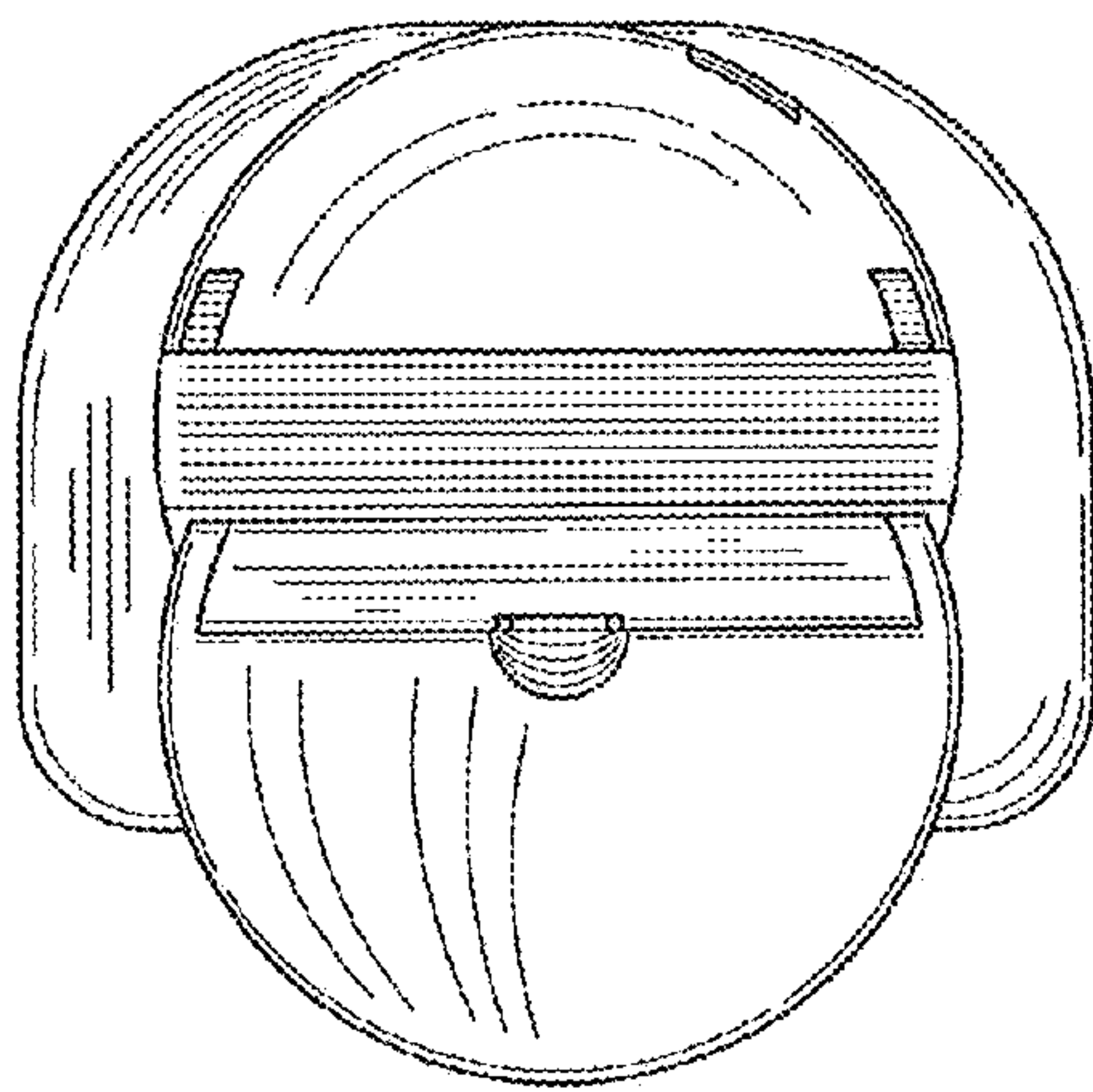

FIG. 26

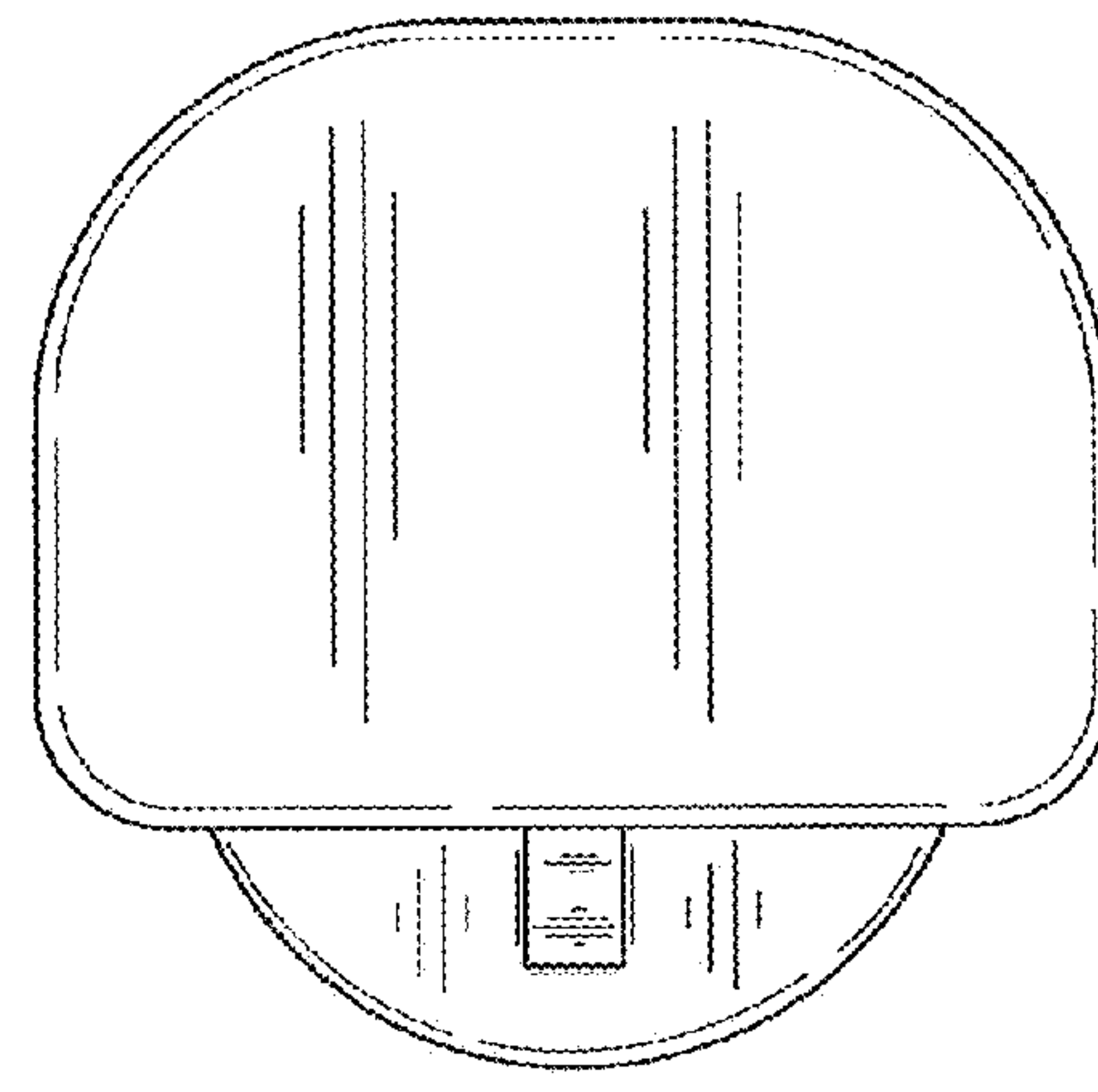

FIG. 27

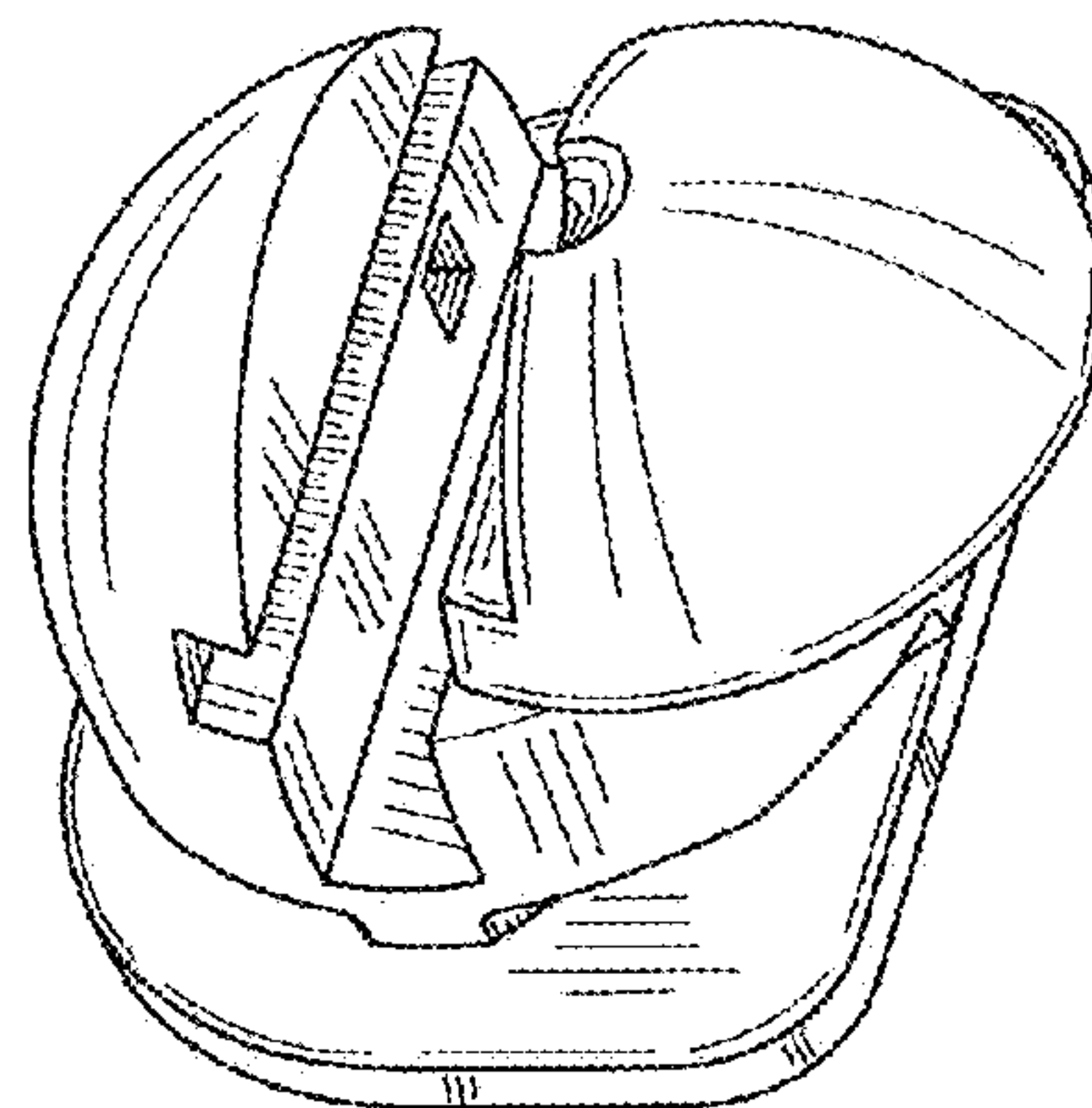

FIG. 28

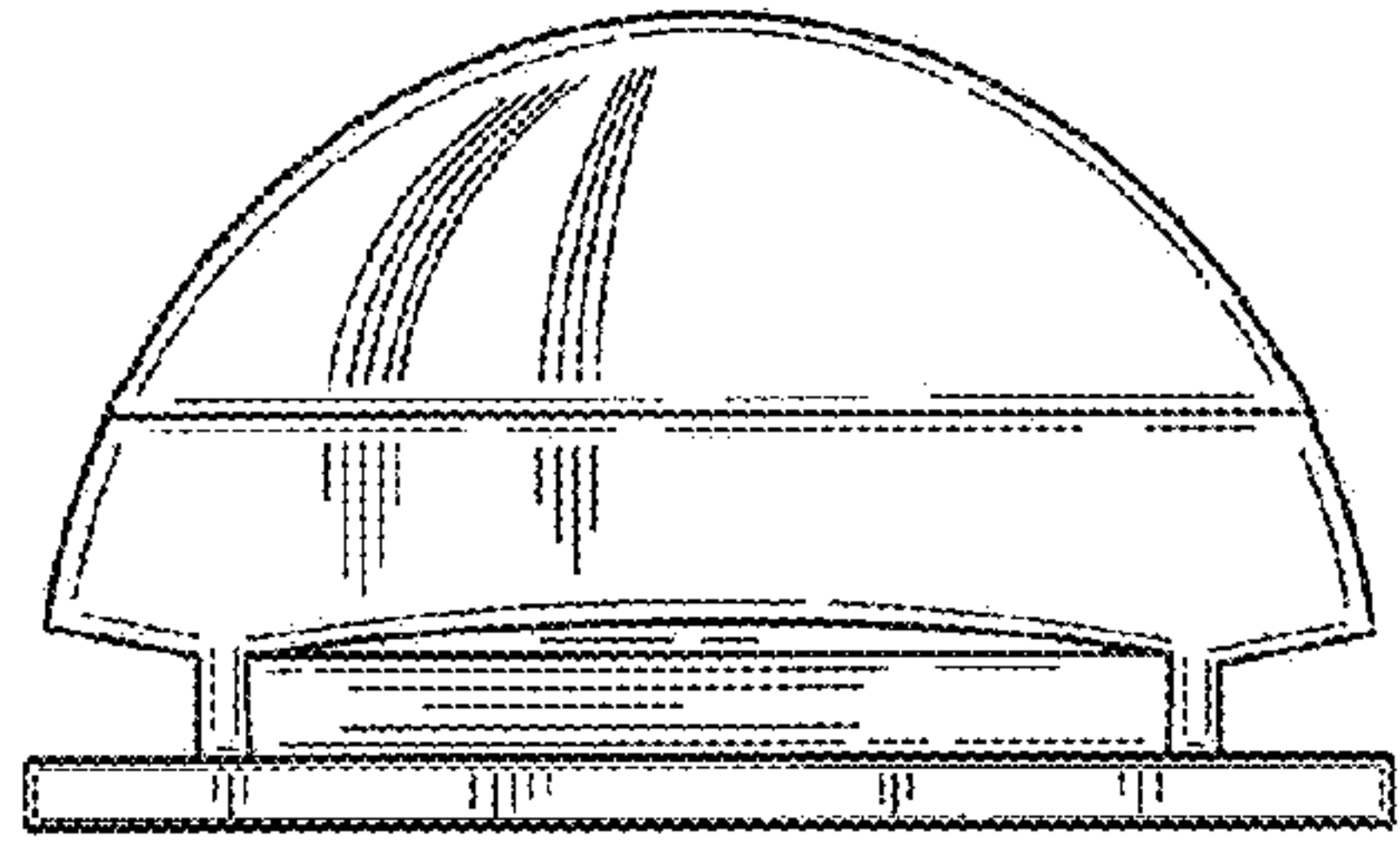

FIG. 29

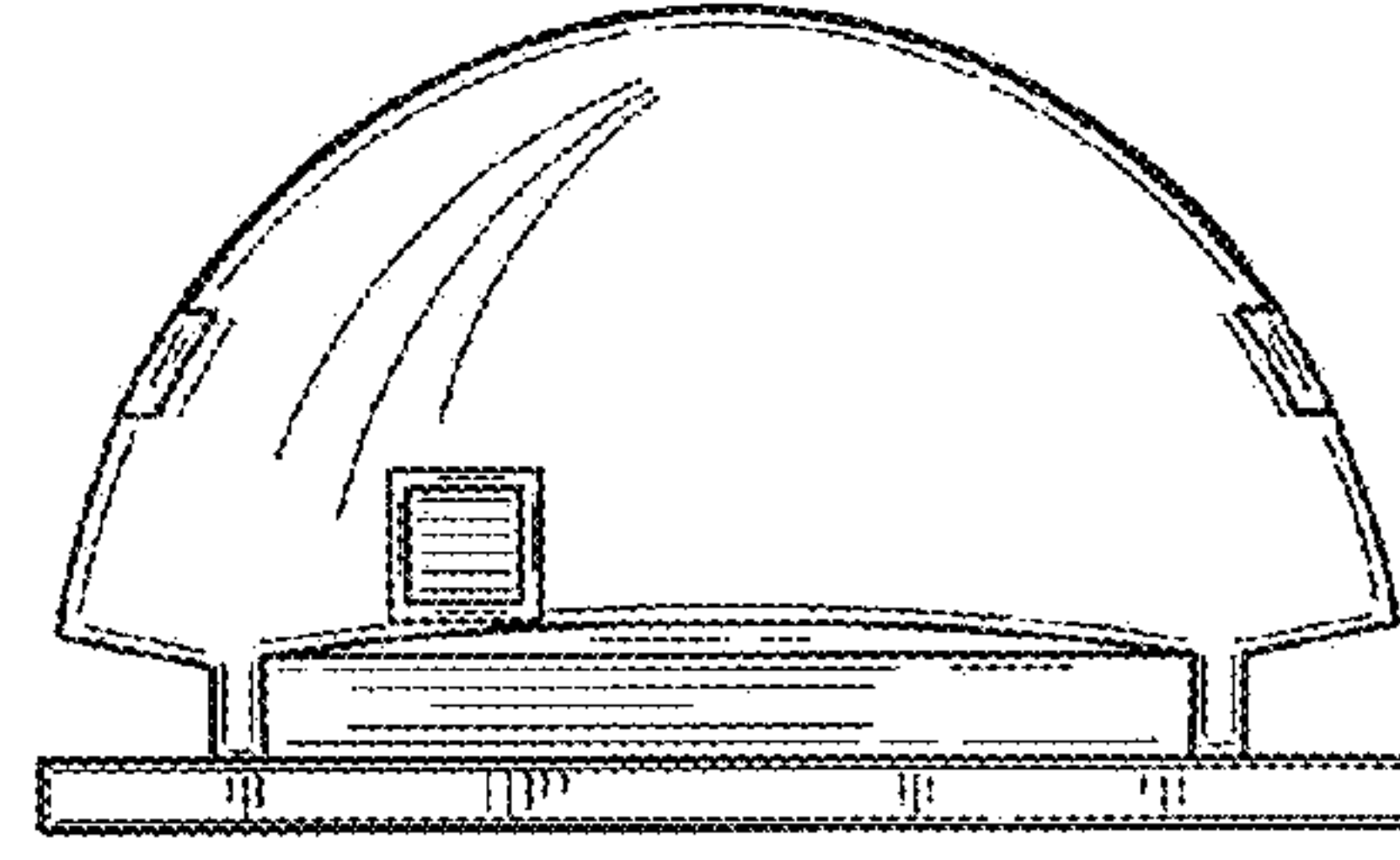

FIG. 30

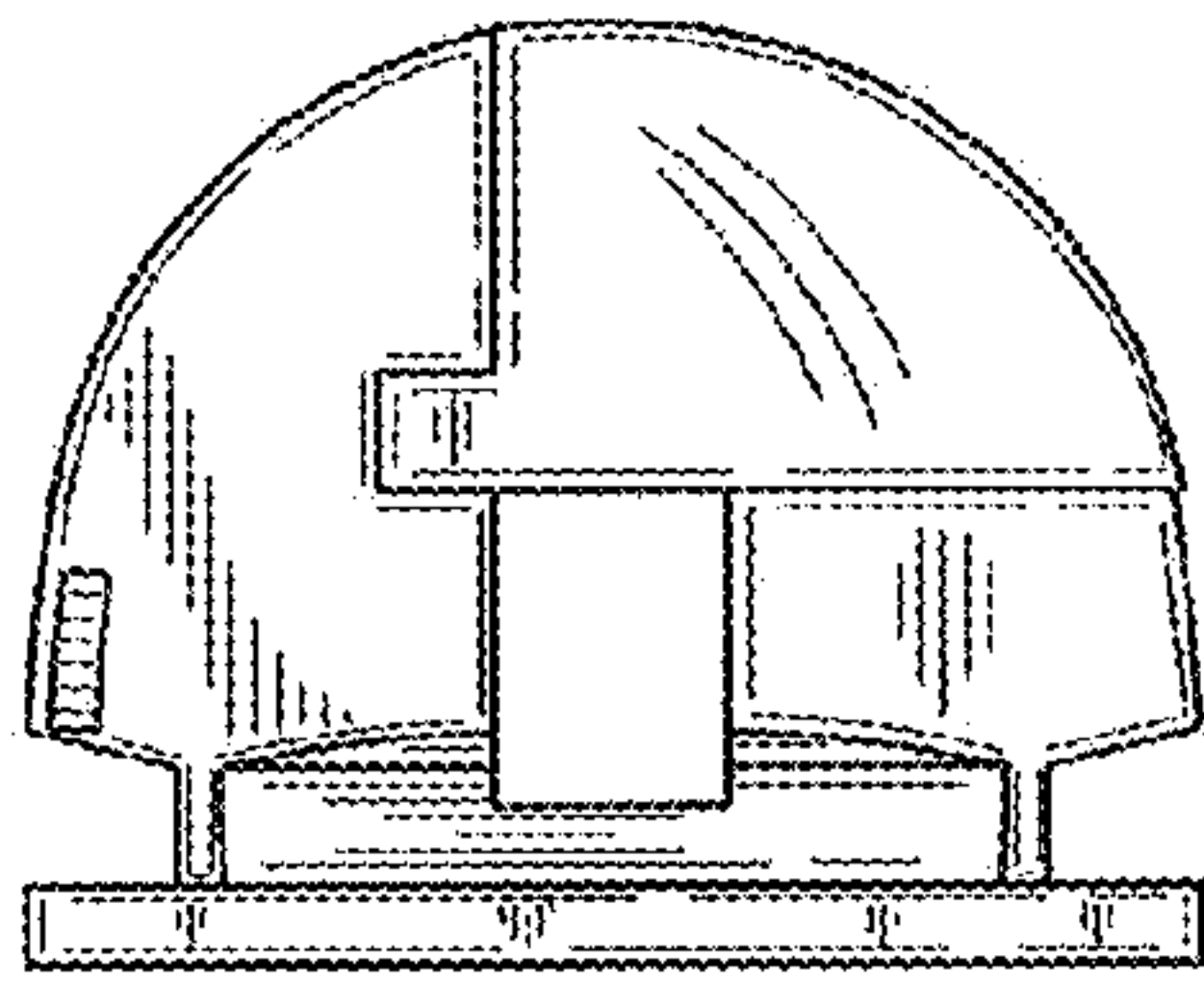

FIG. 31

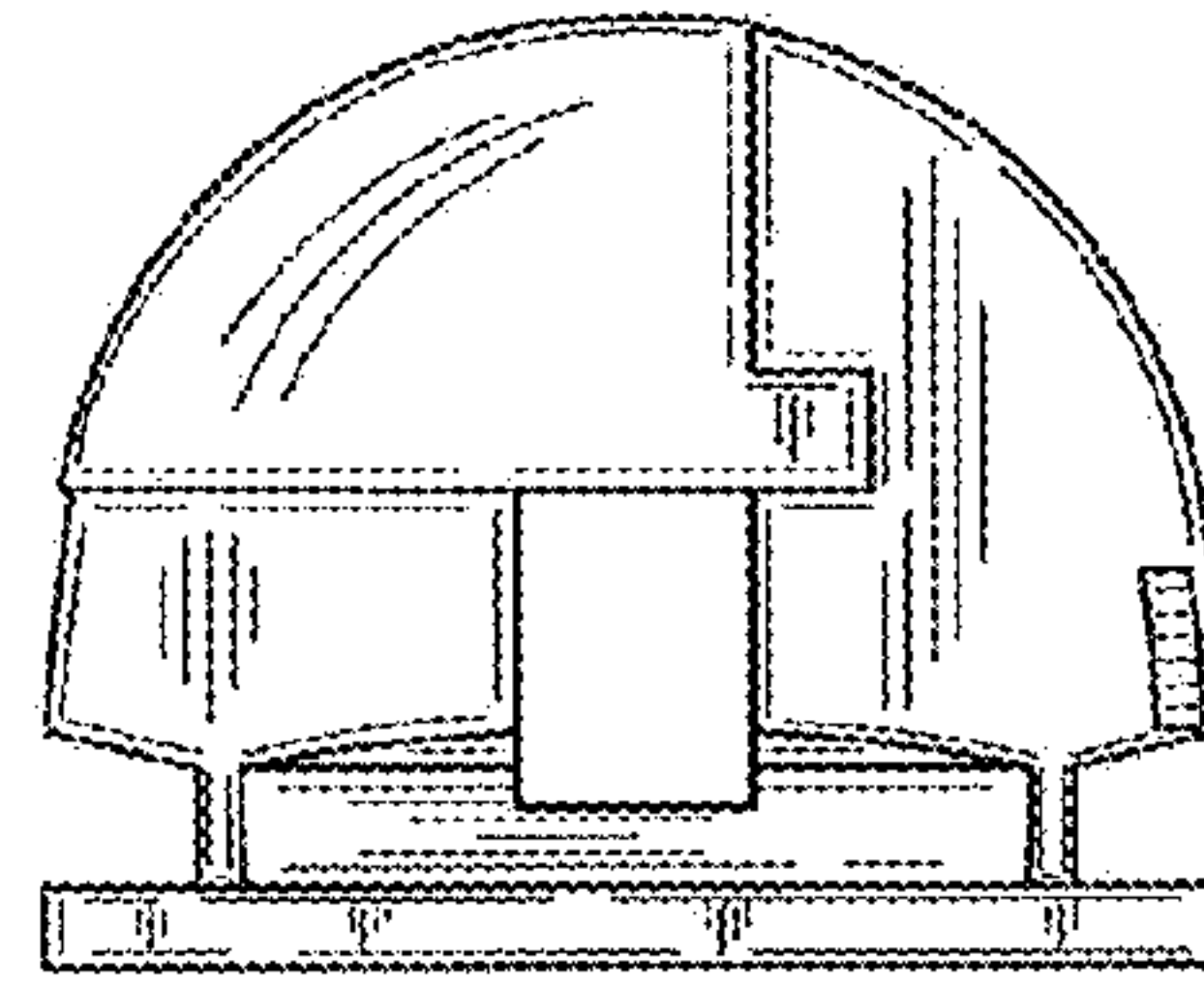

FIG. 32

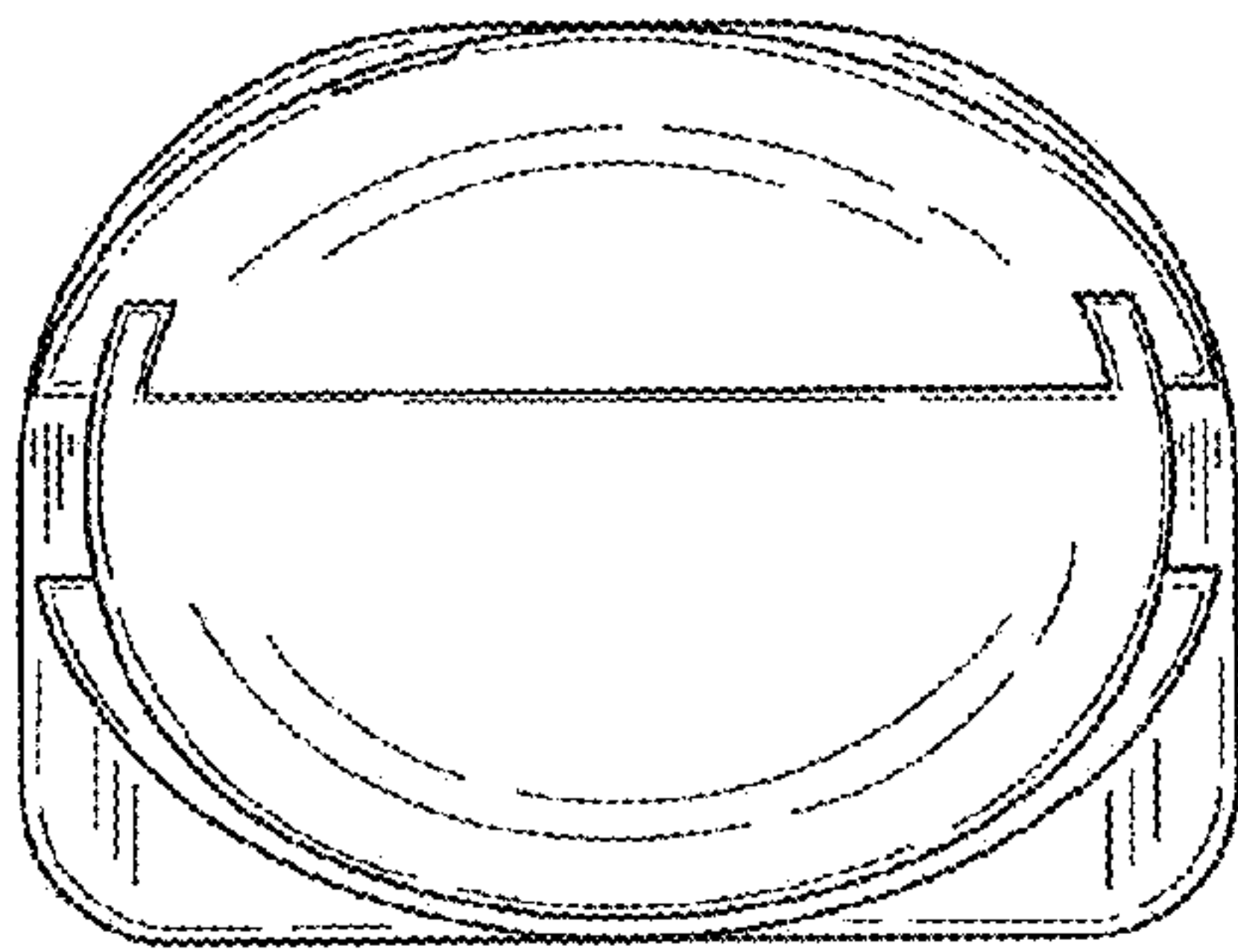

FIG. 33

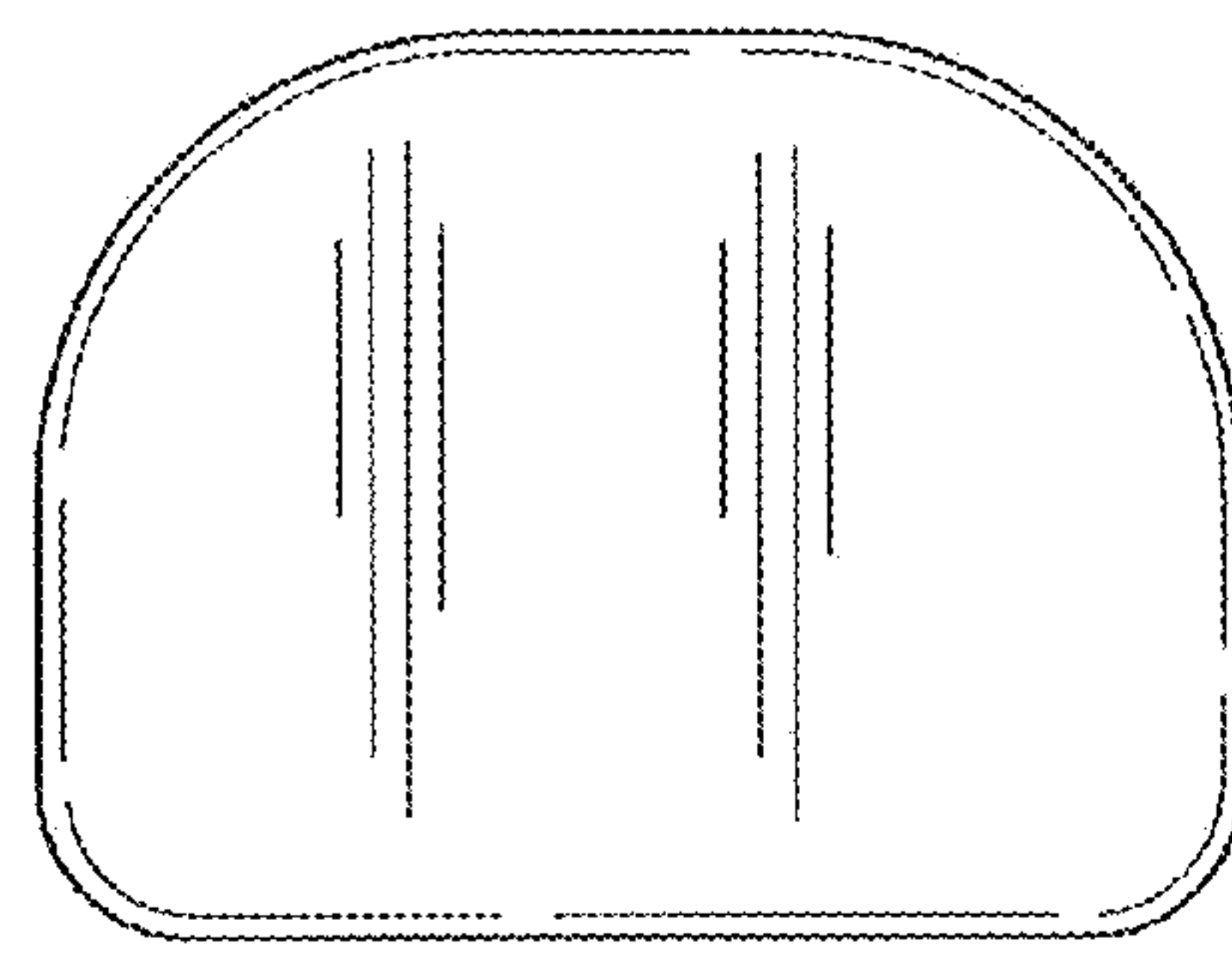

FIG. 34

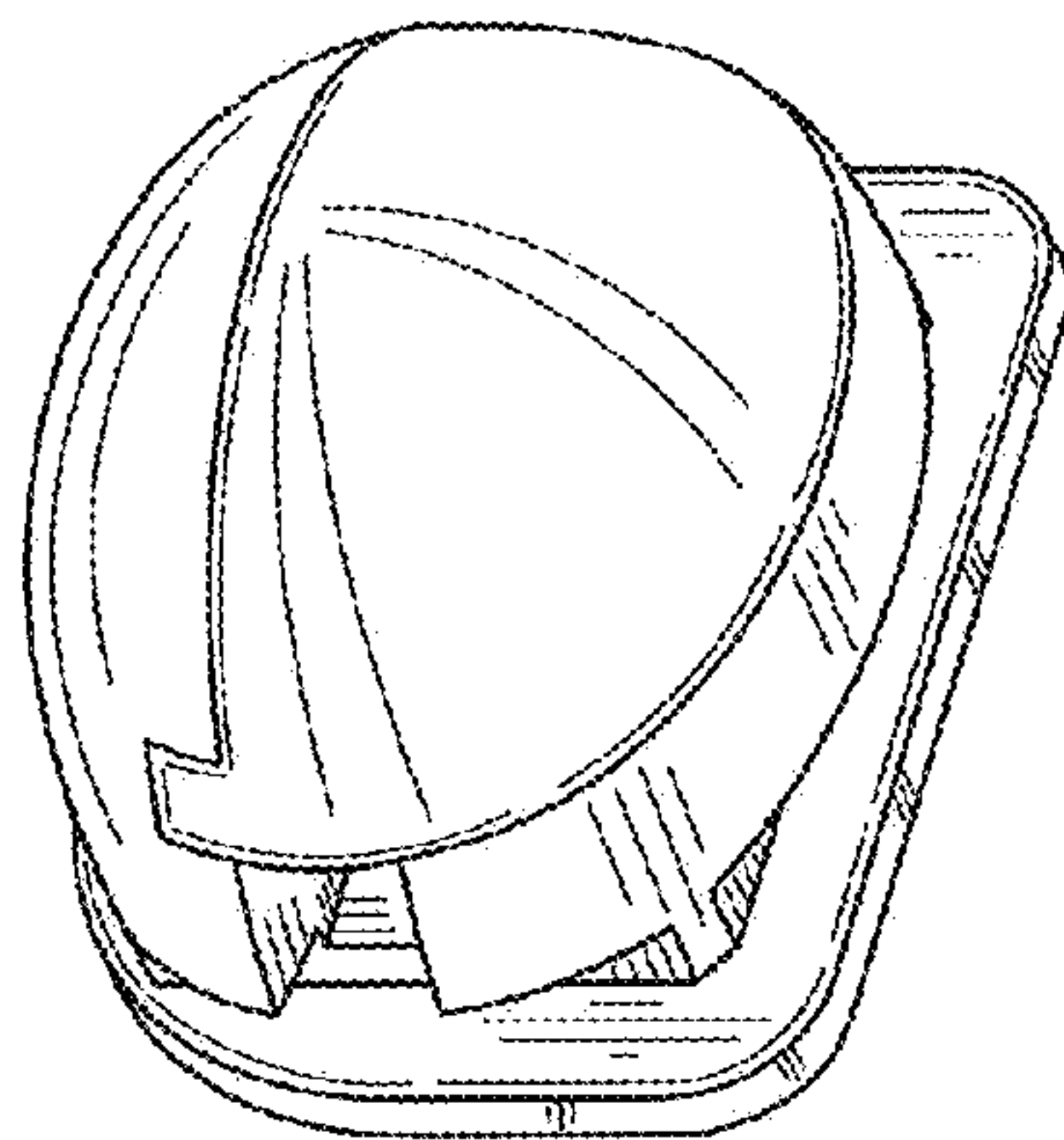

FIG. 35

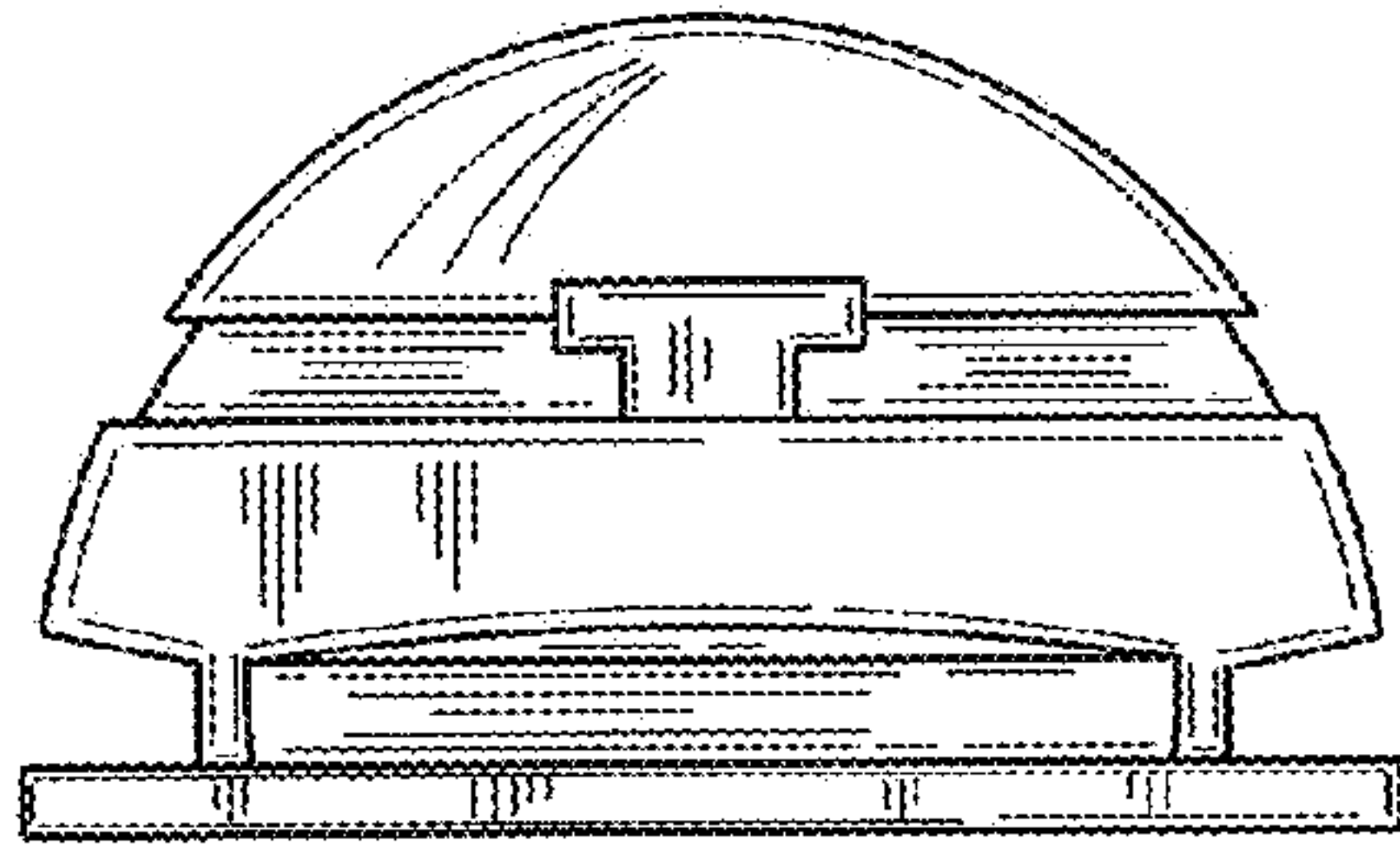

FIG.36

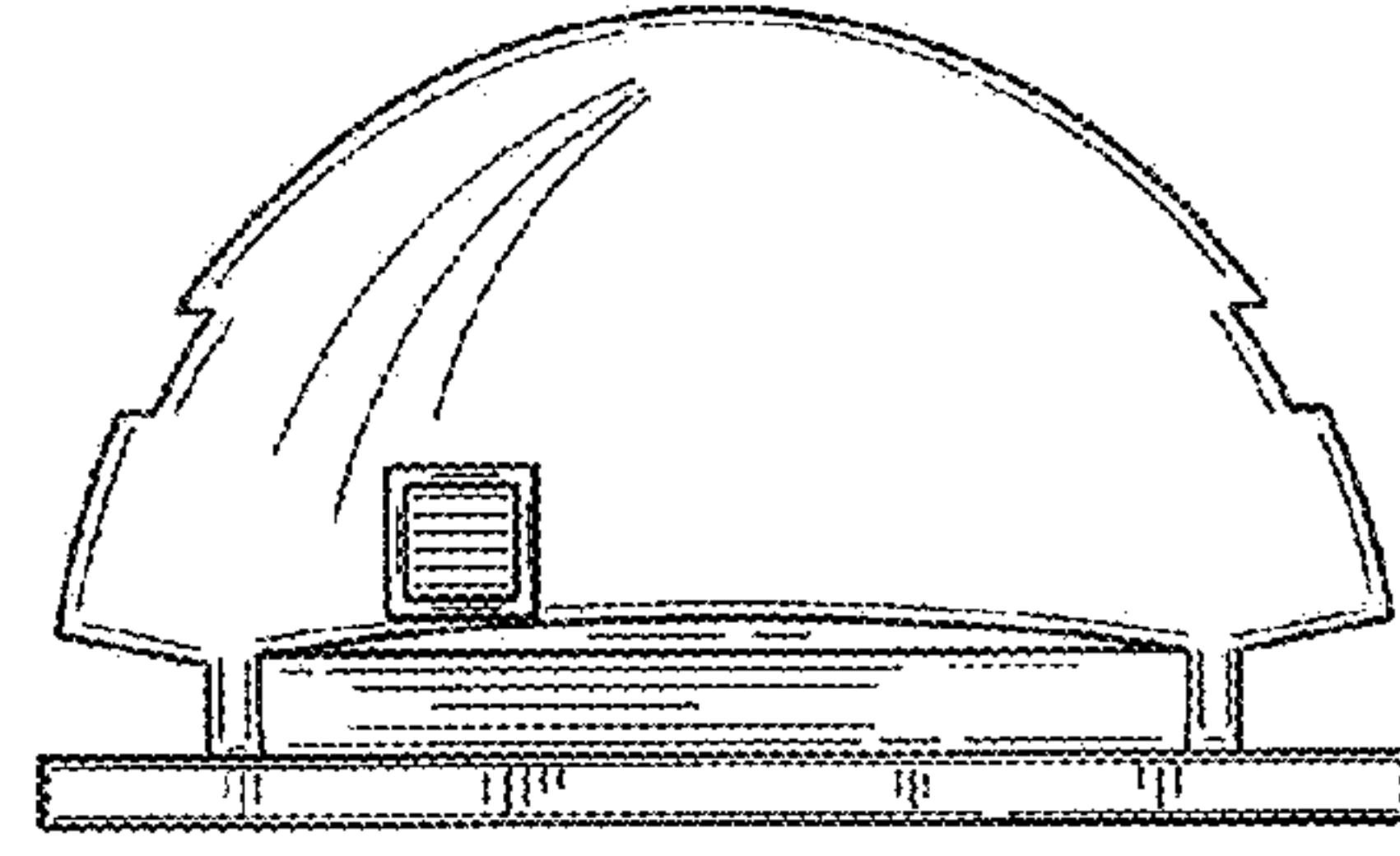

FIG.37

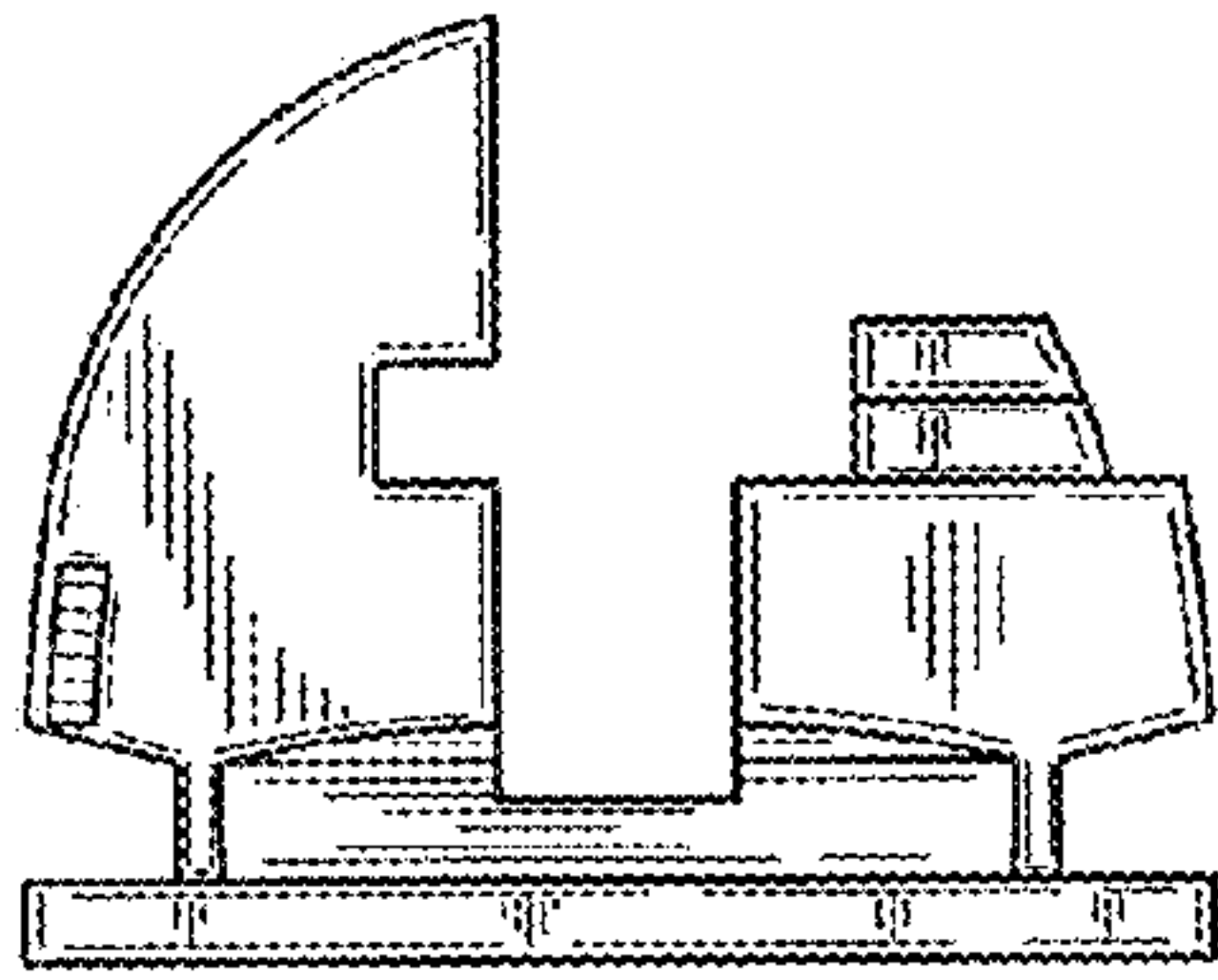

FIG.38

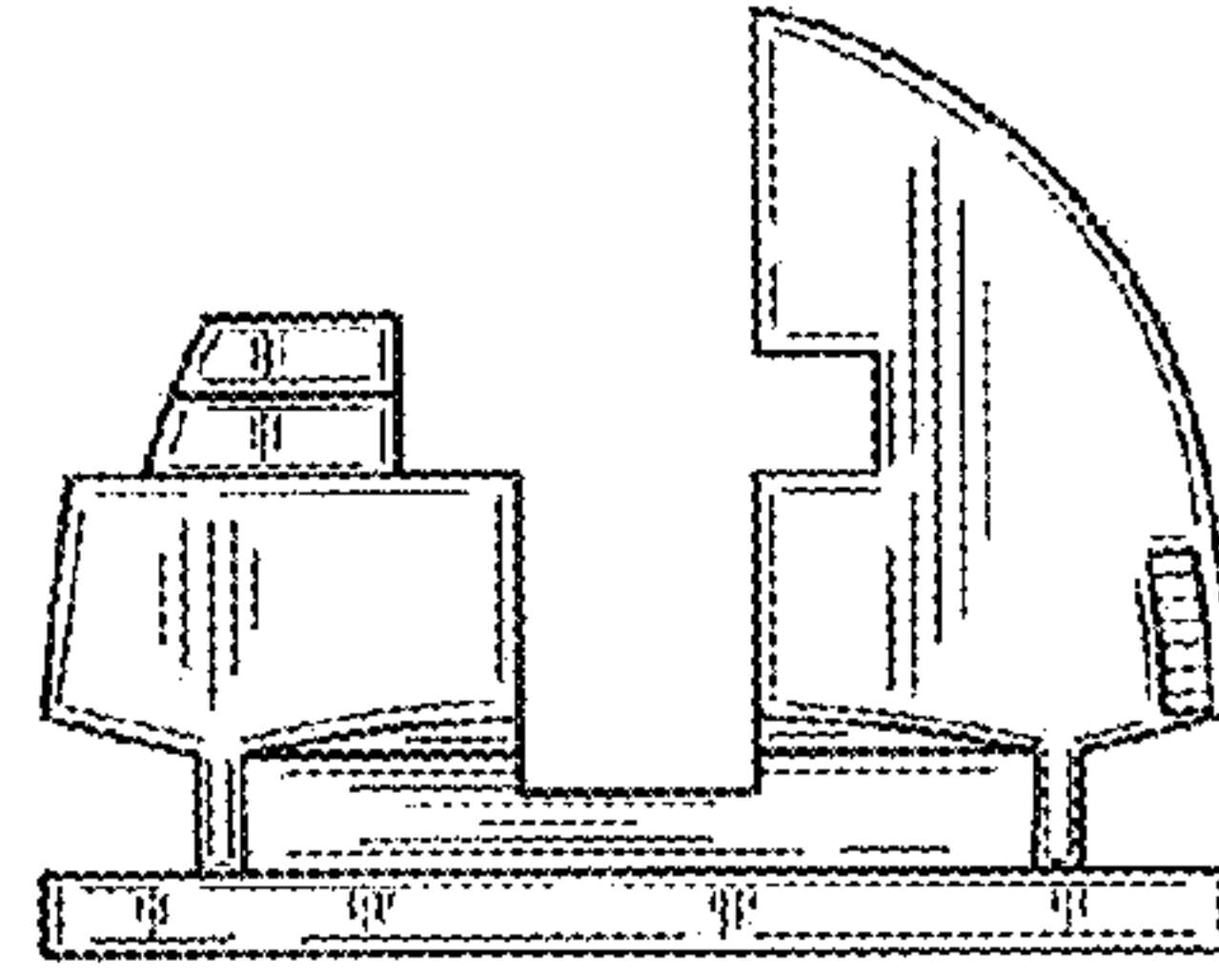

FIG.39

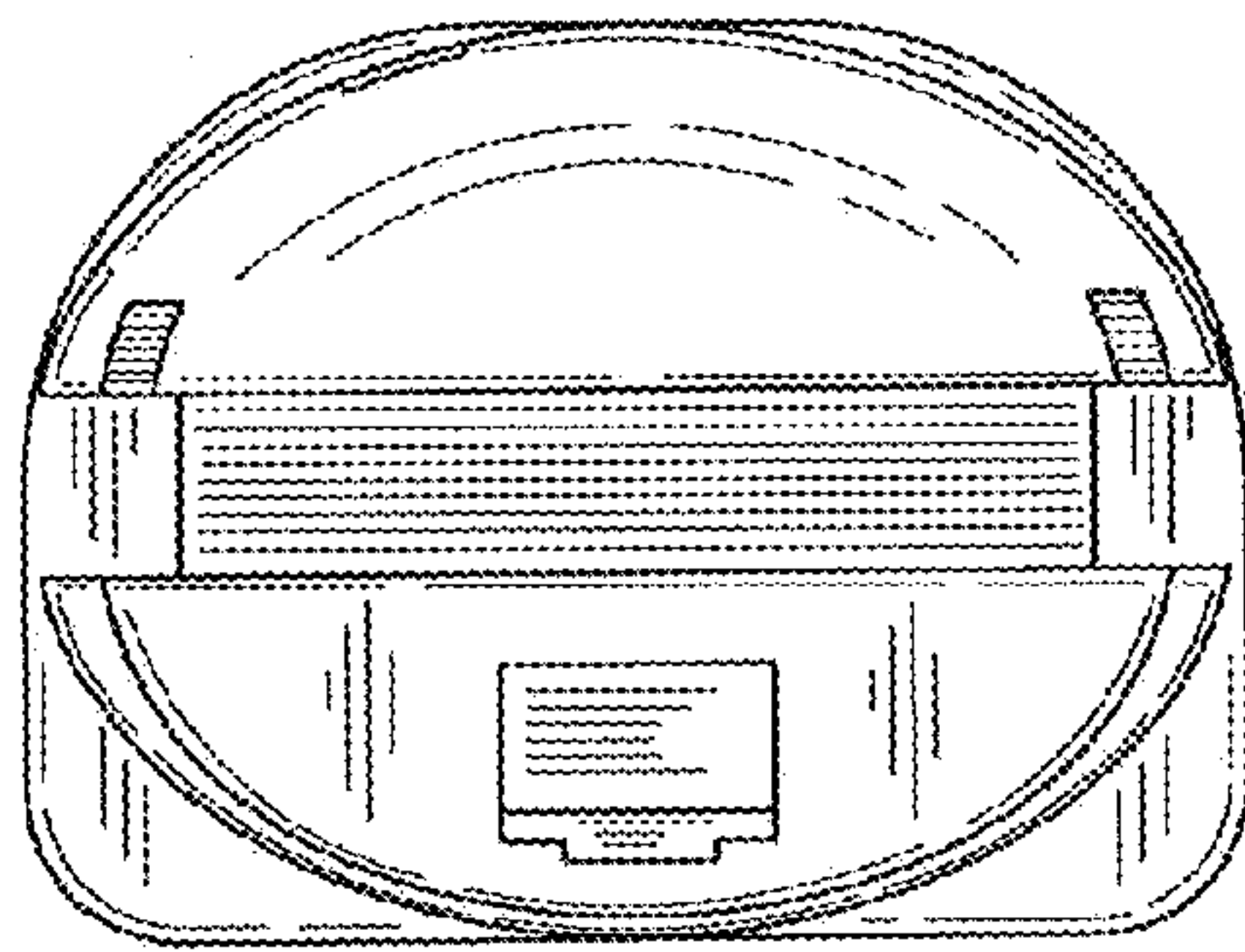

FIG.40

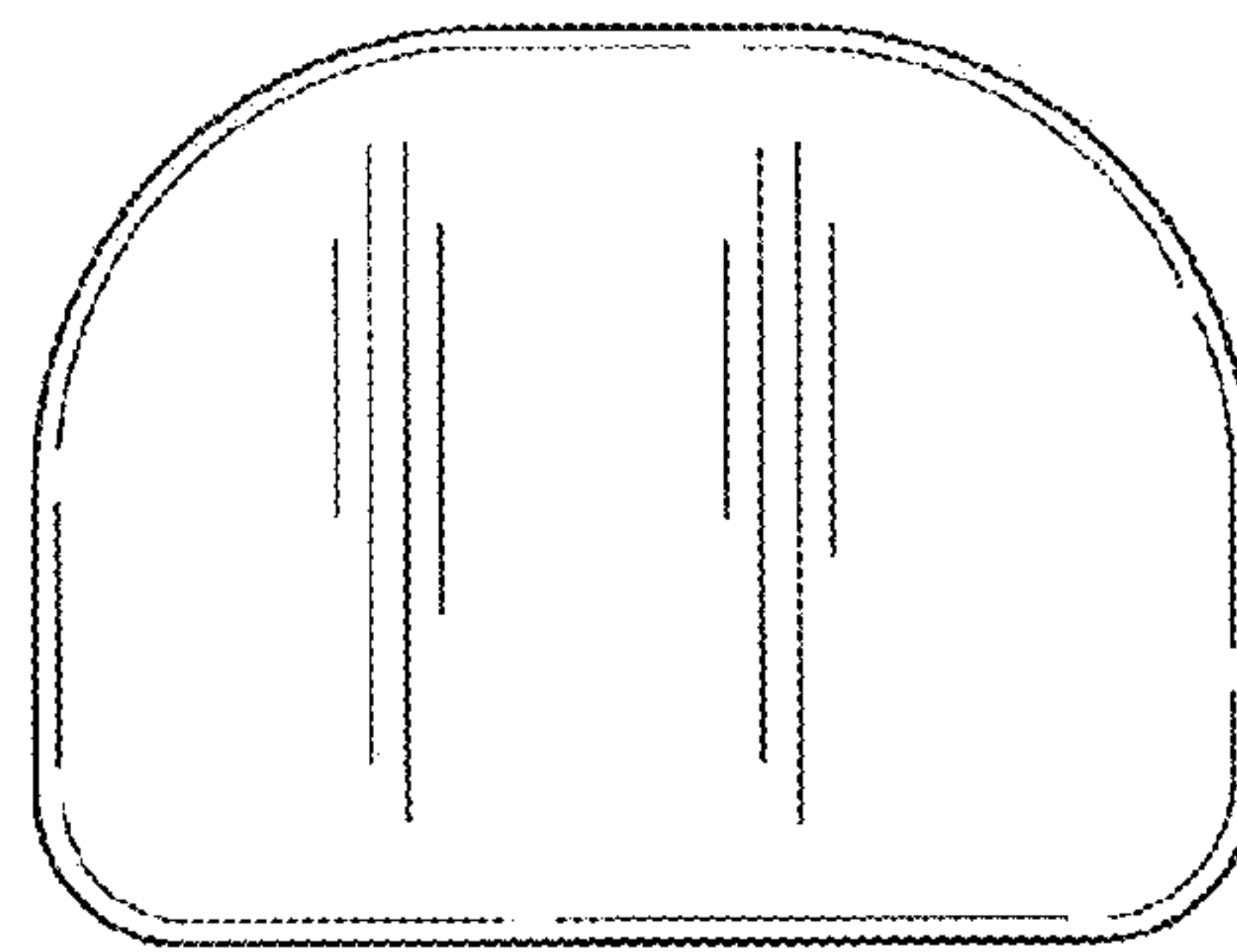

FIG.41

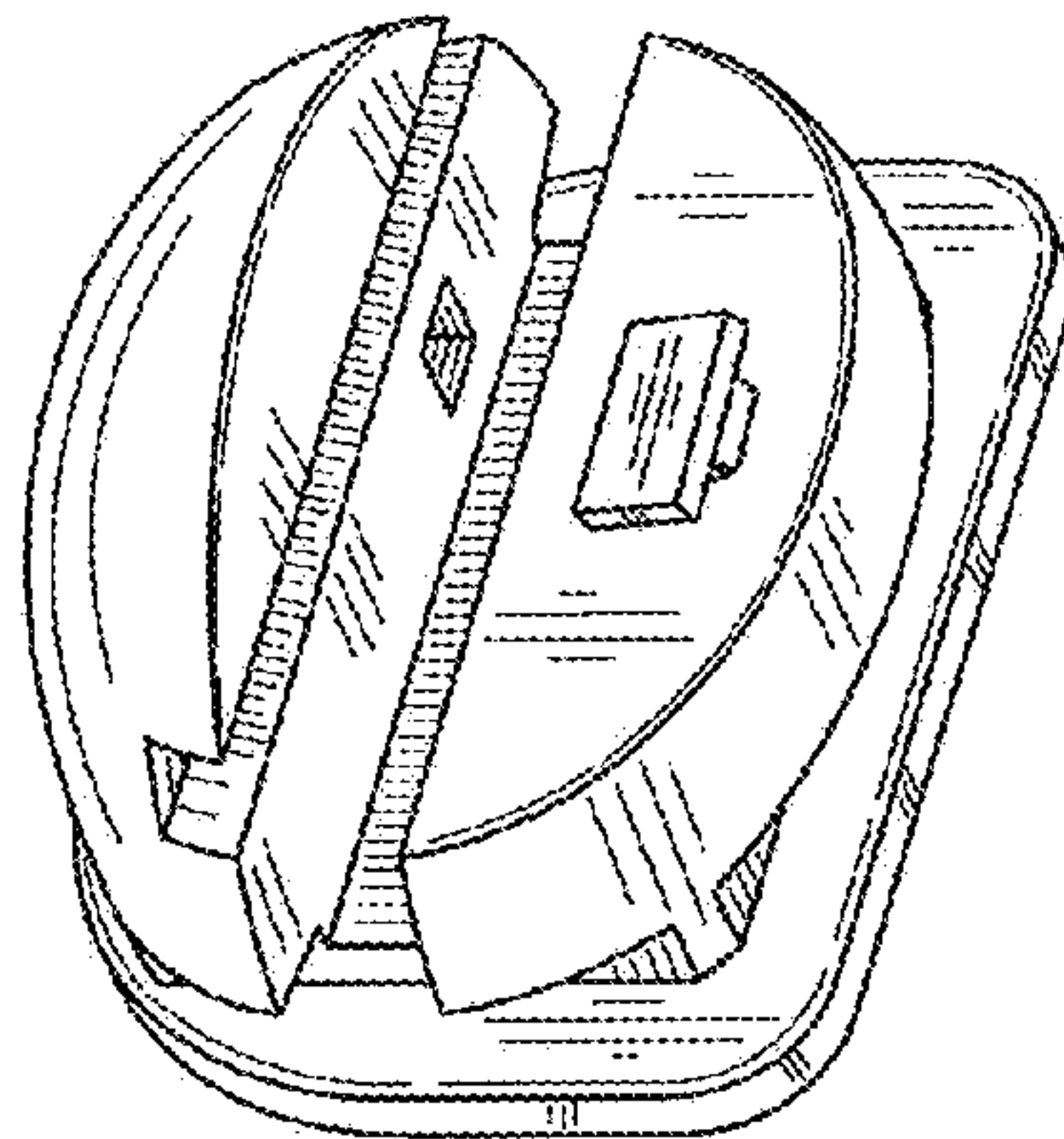

FIG.42



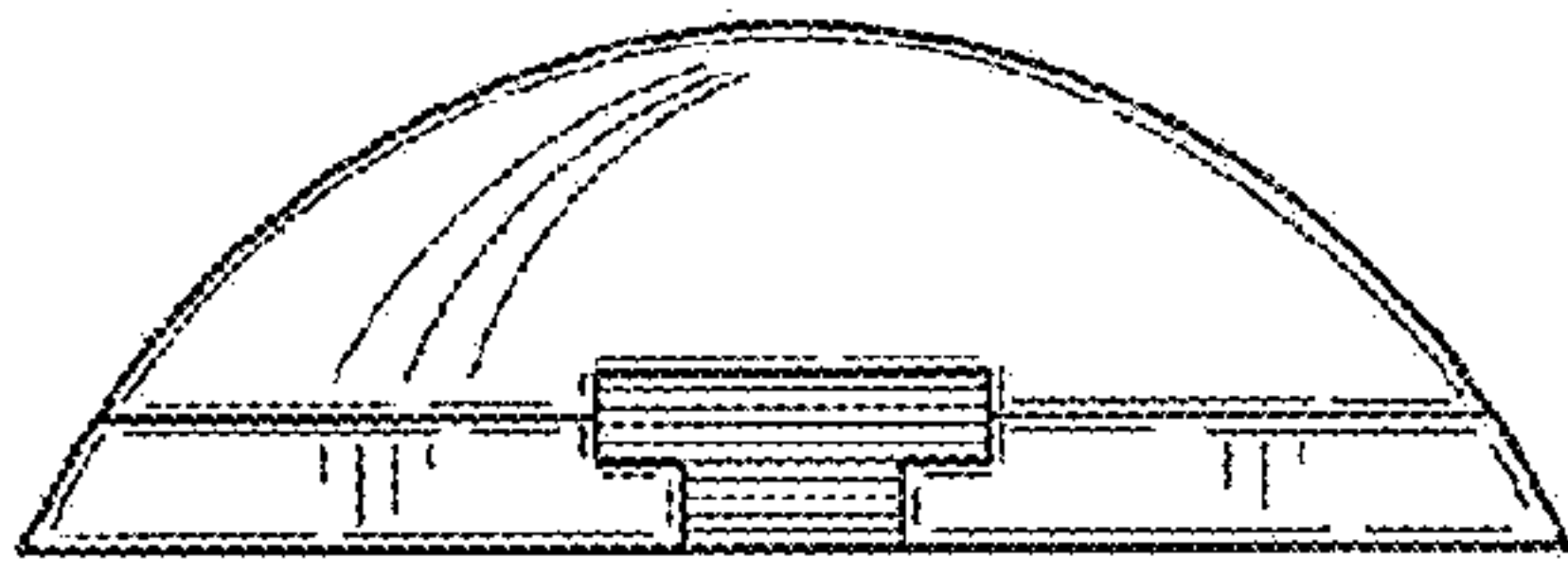

FIG. 43

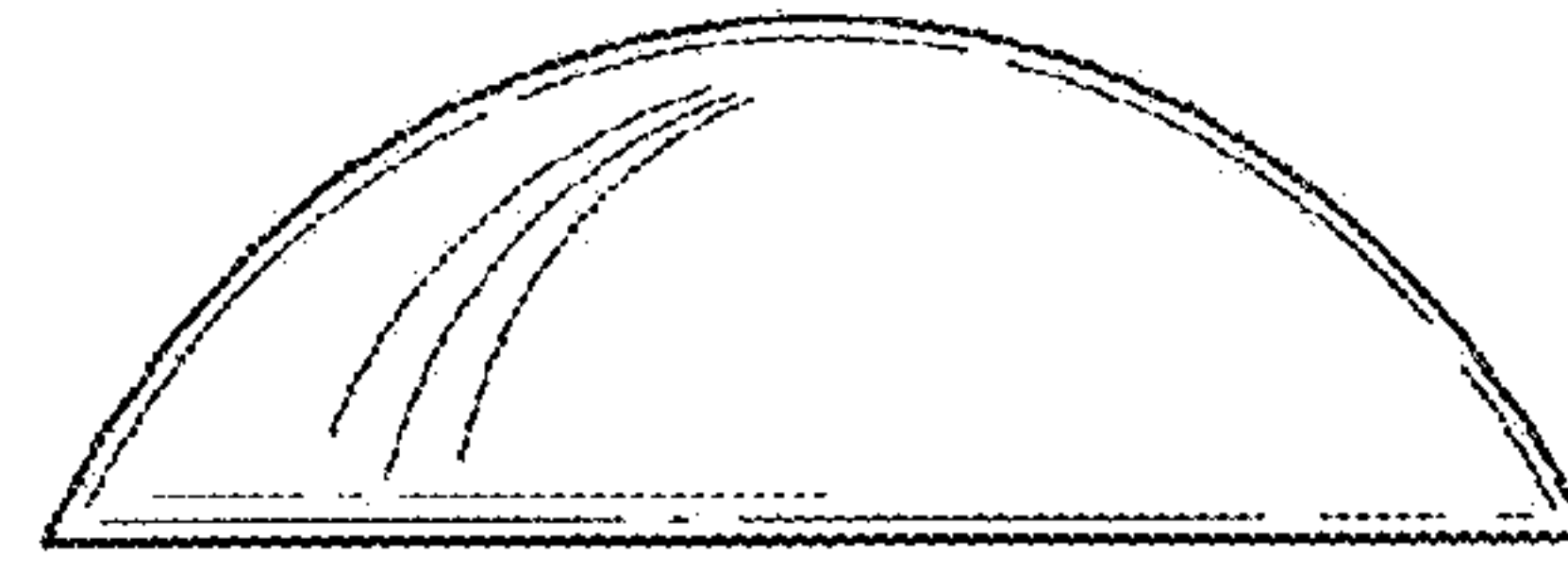

FIG. 44

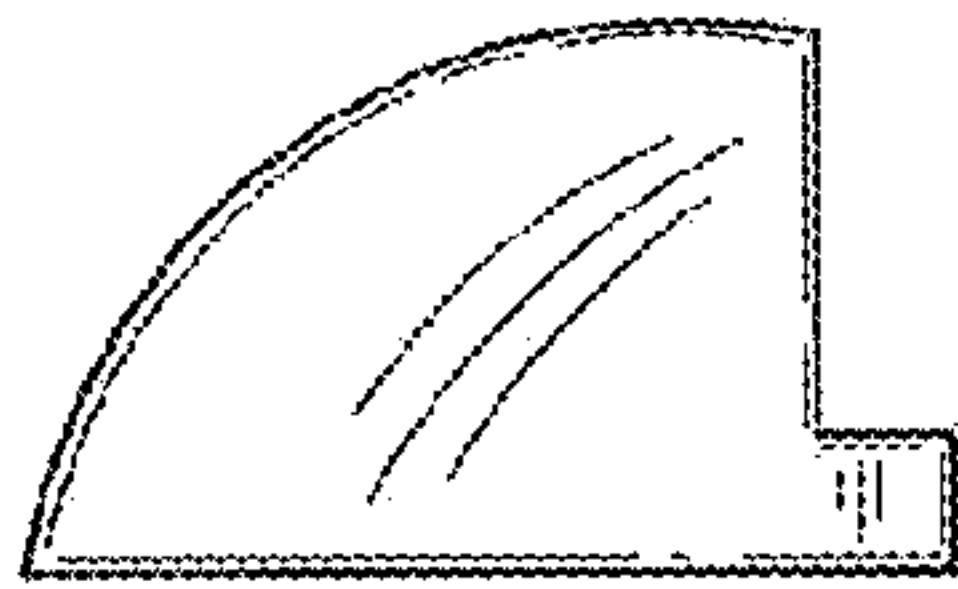

FIG. 45

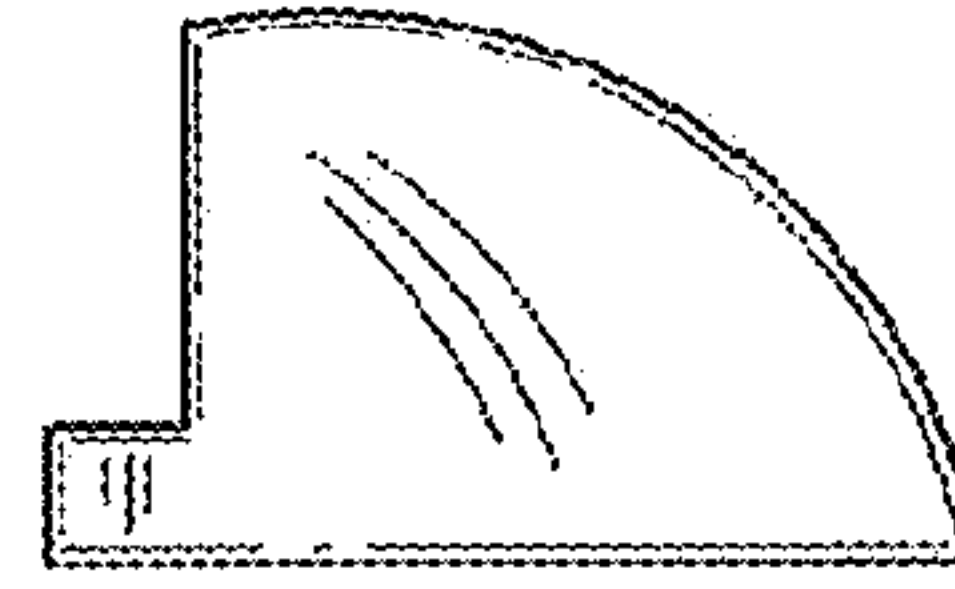

FIG. 46

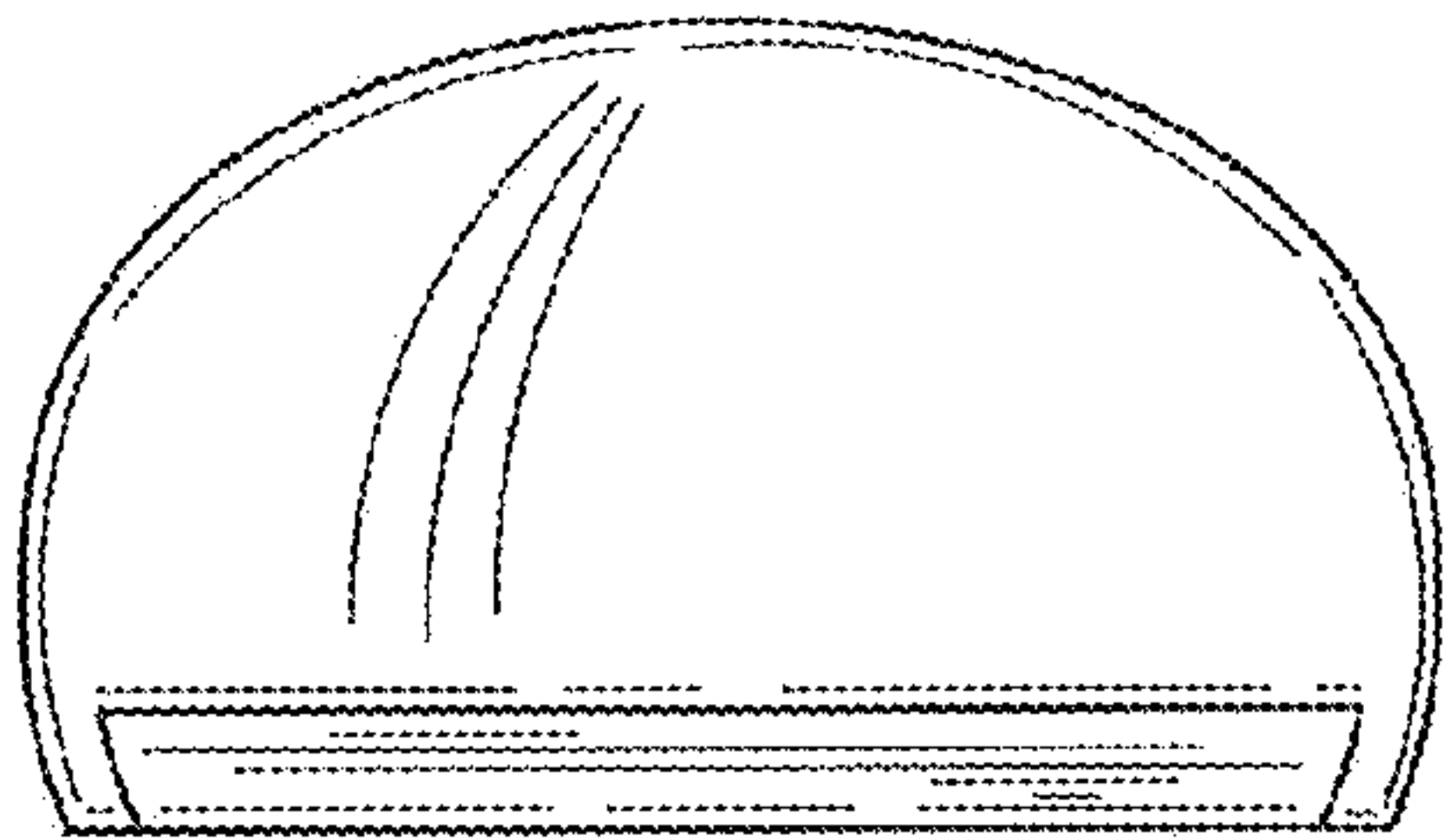

FIG. 47

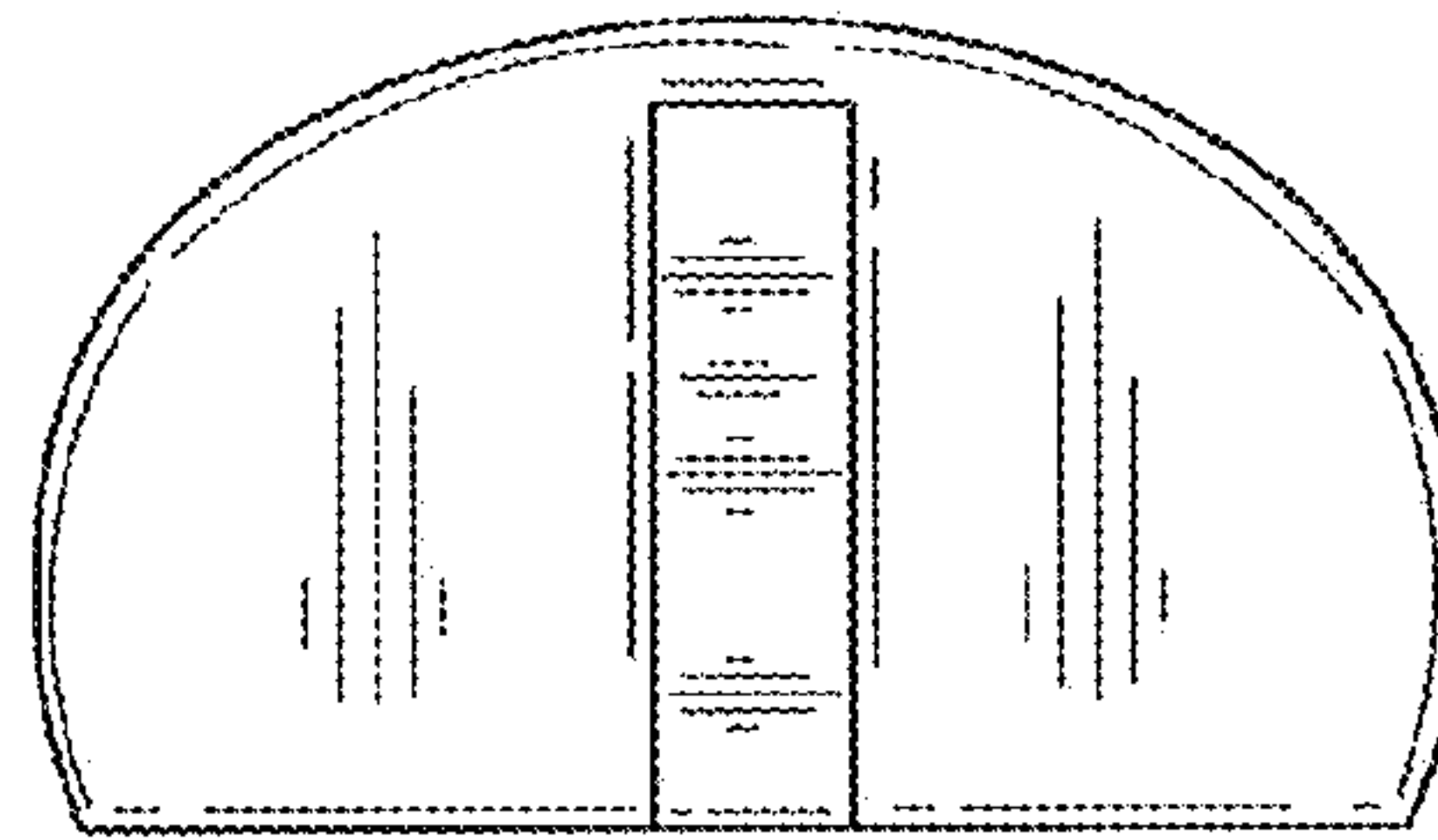

FIG. 48

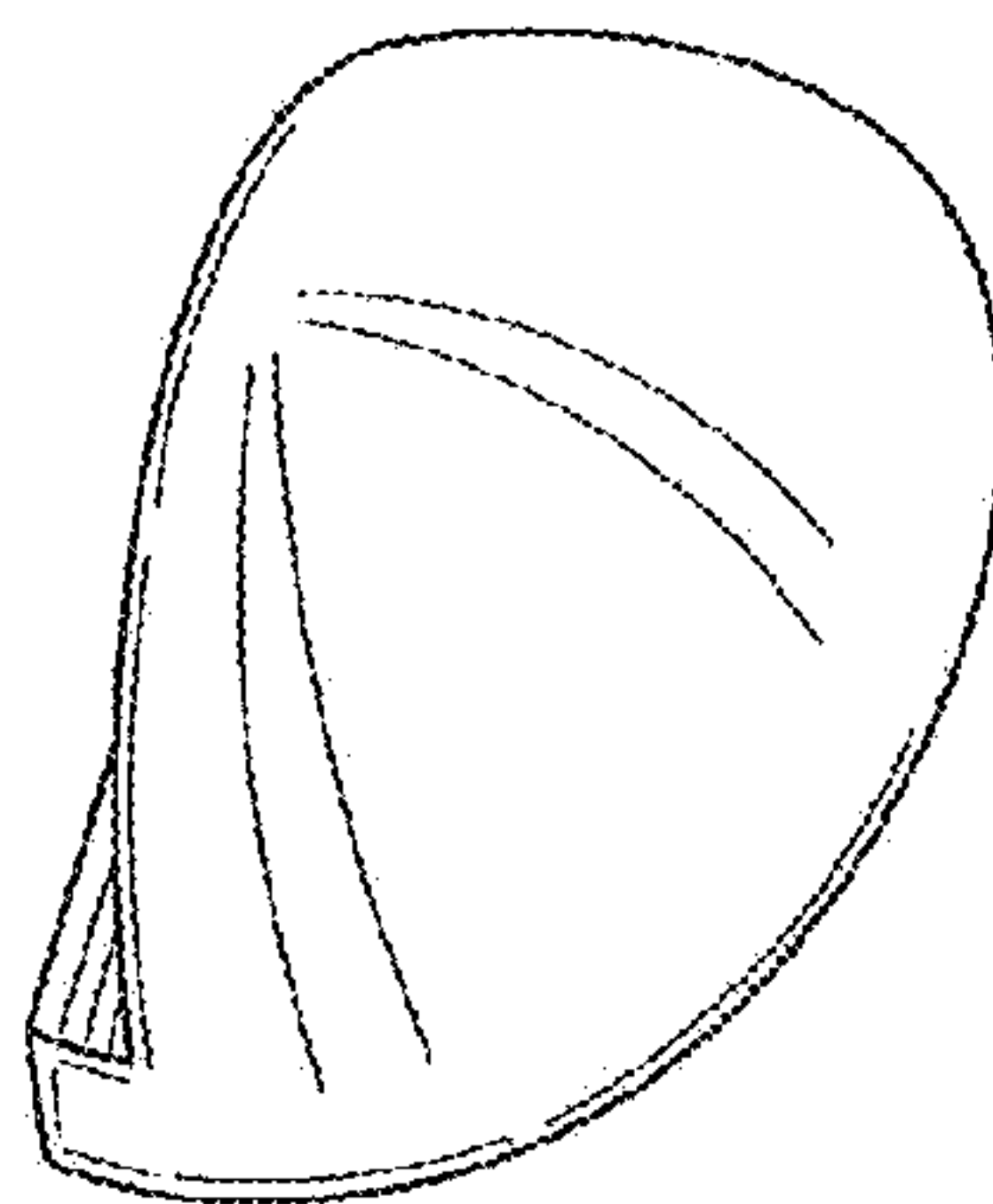

FIG. 49

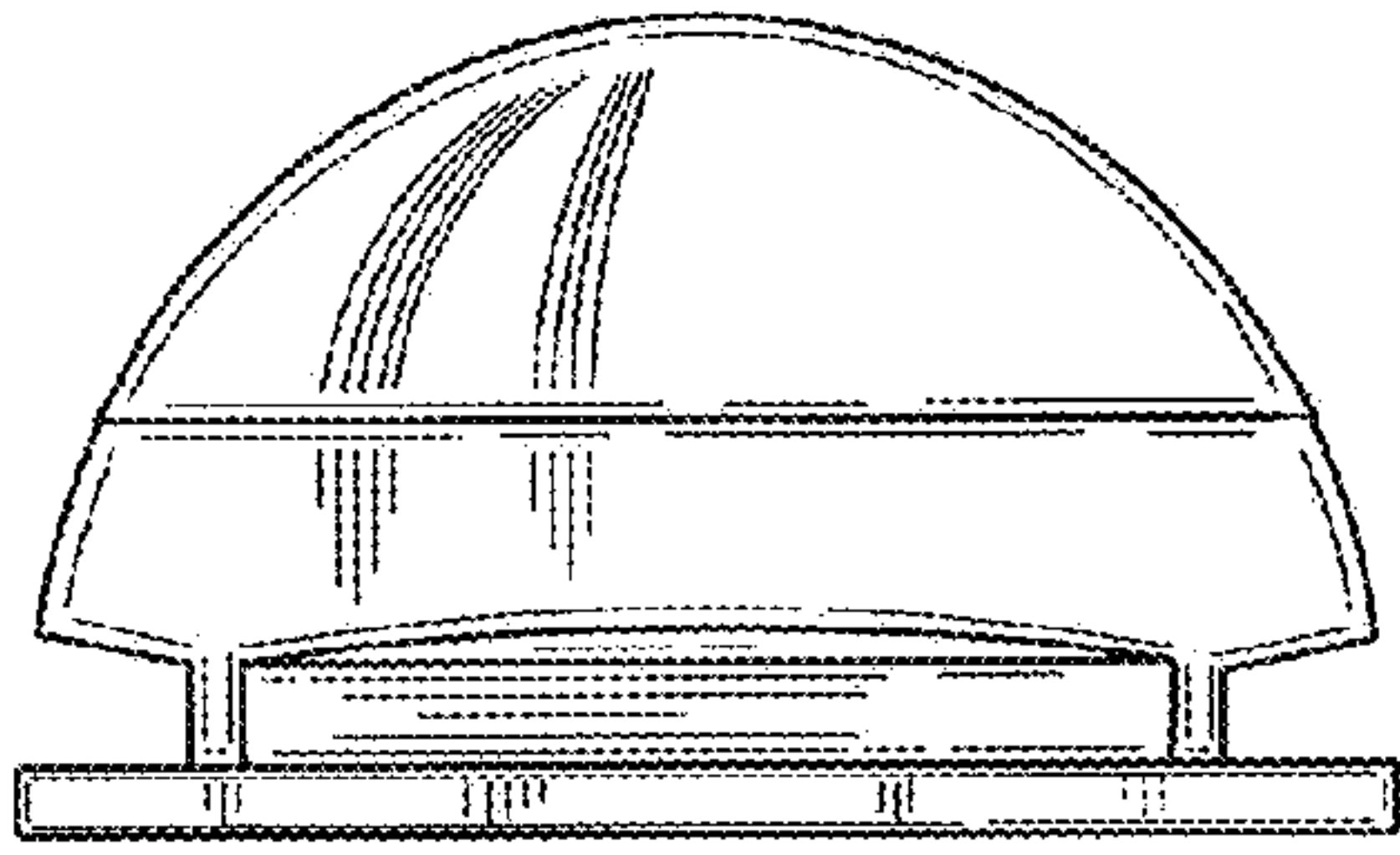

FIG. 50

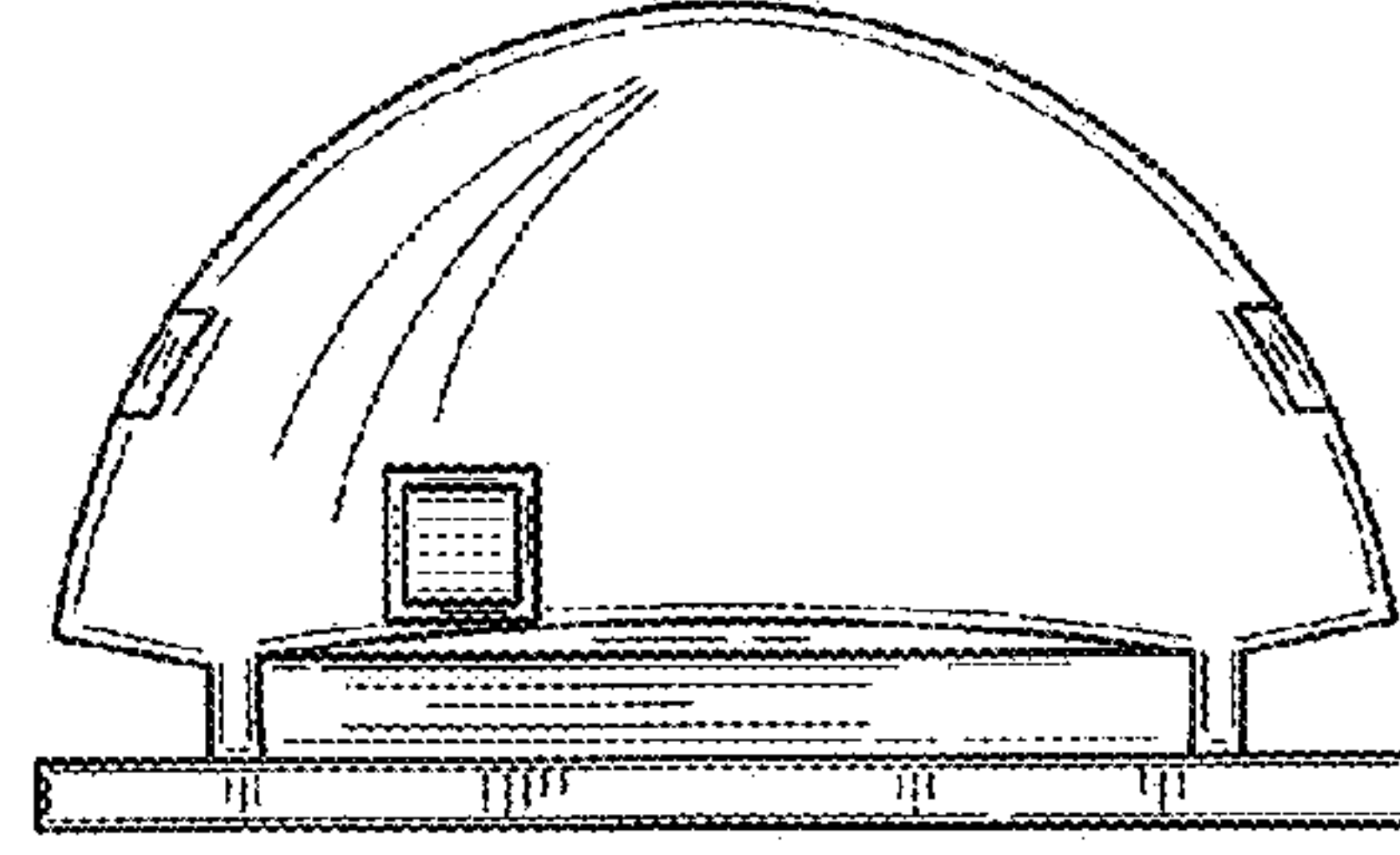

FIG. 51

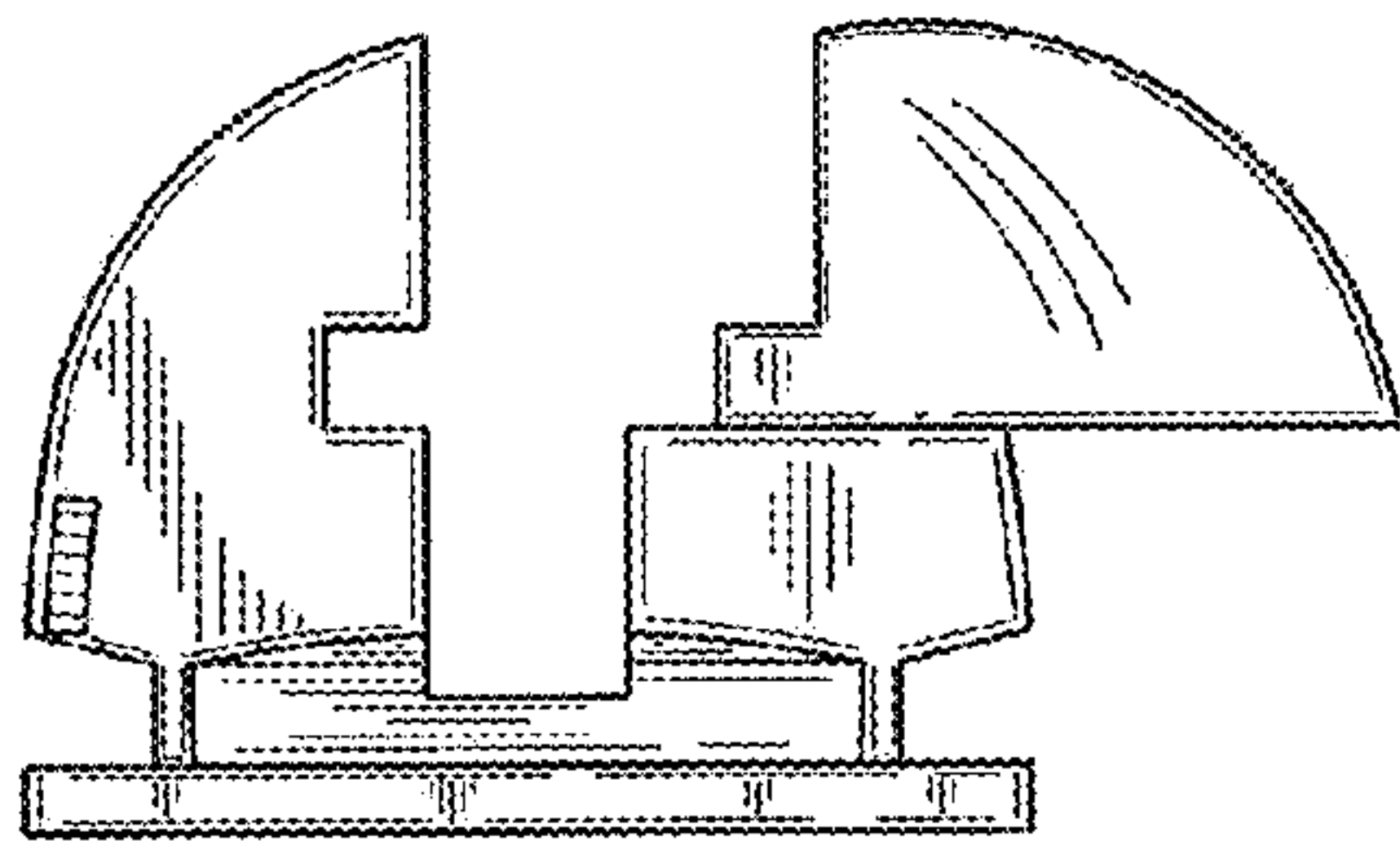

FIG. 52

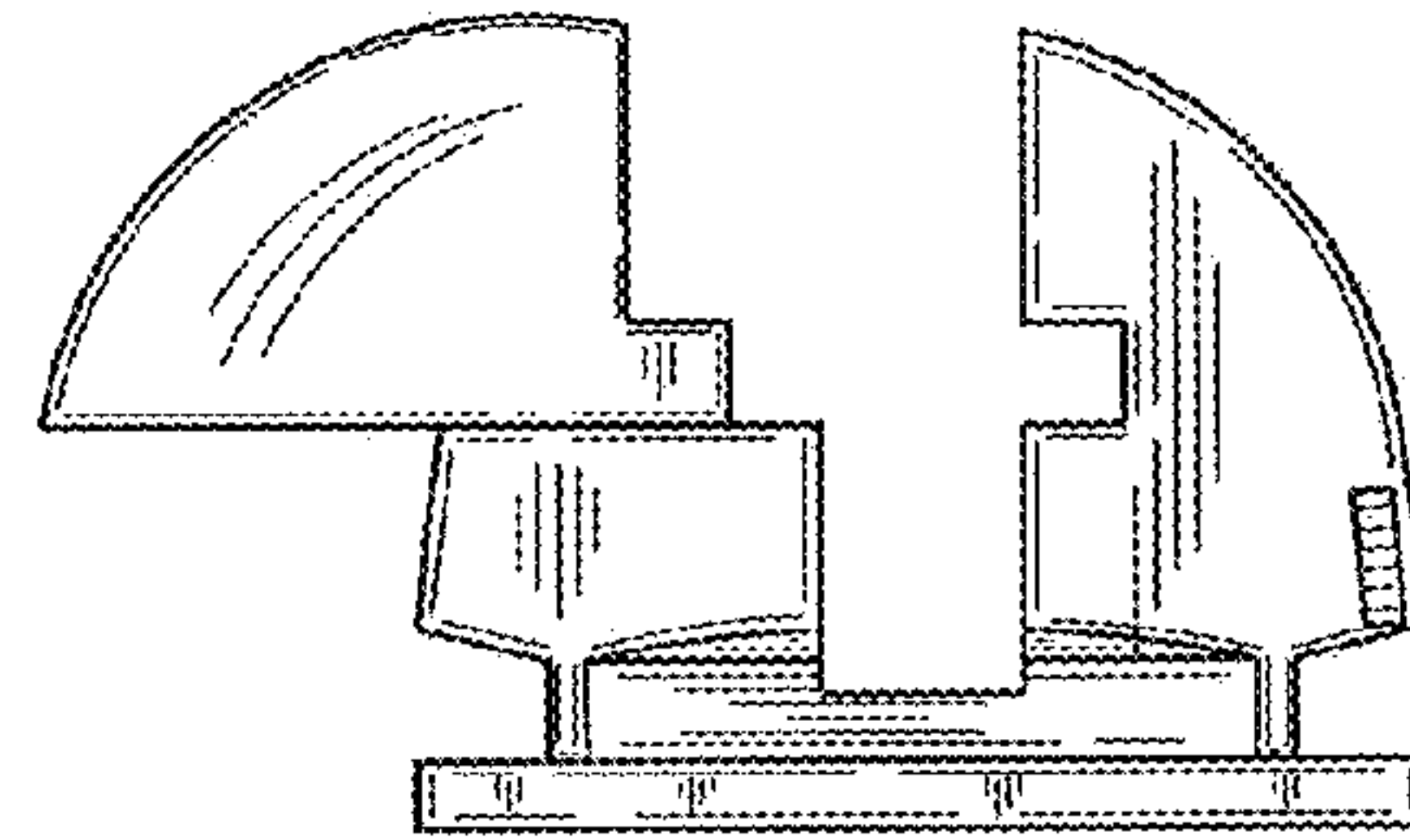

FIG. 53

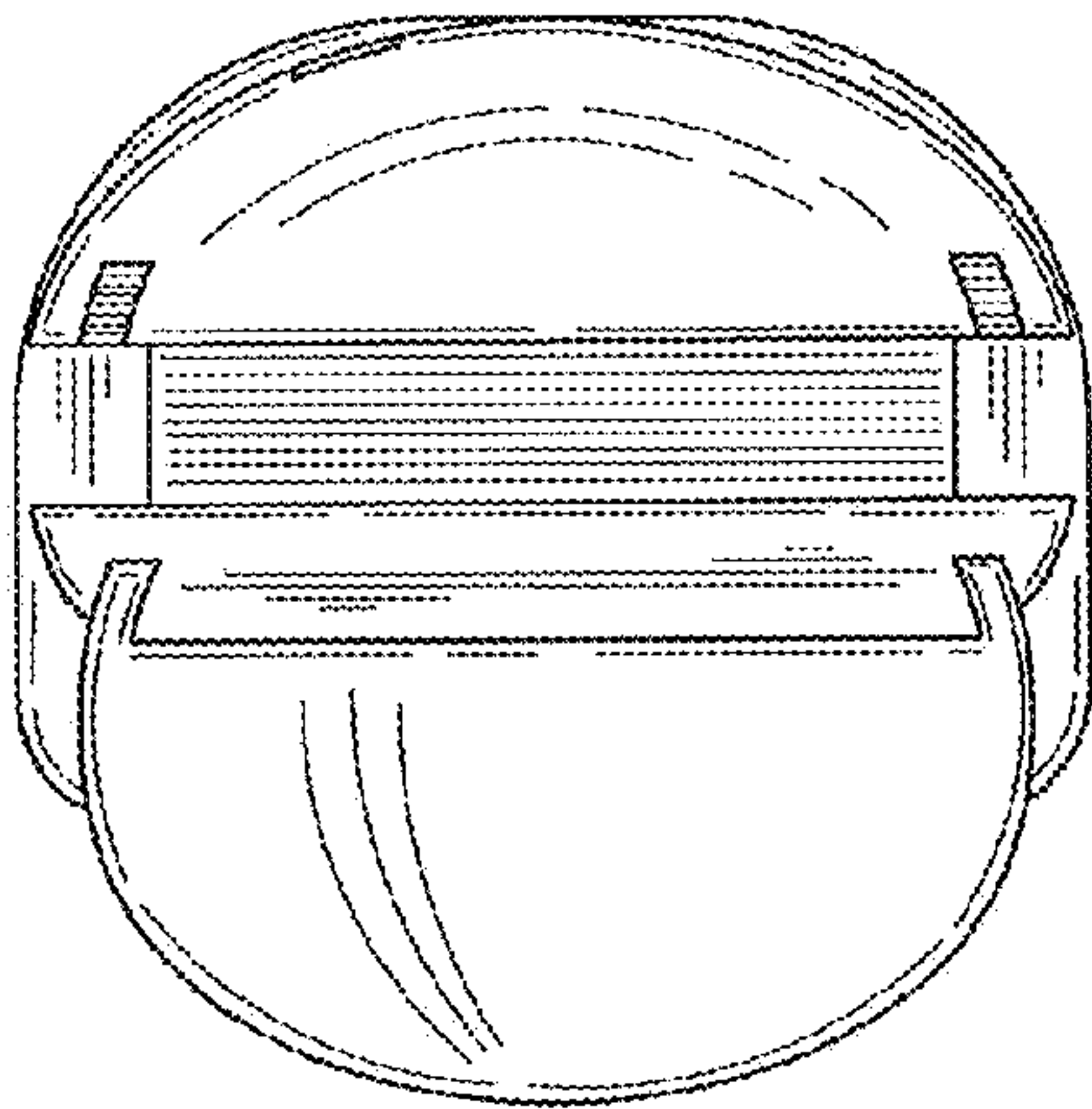

FIG. 54

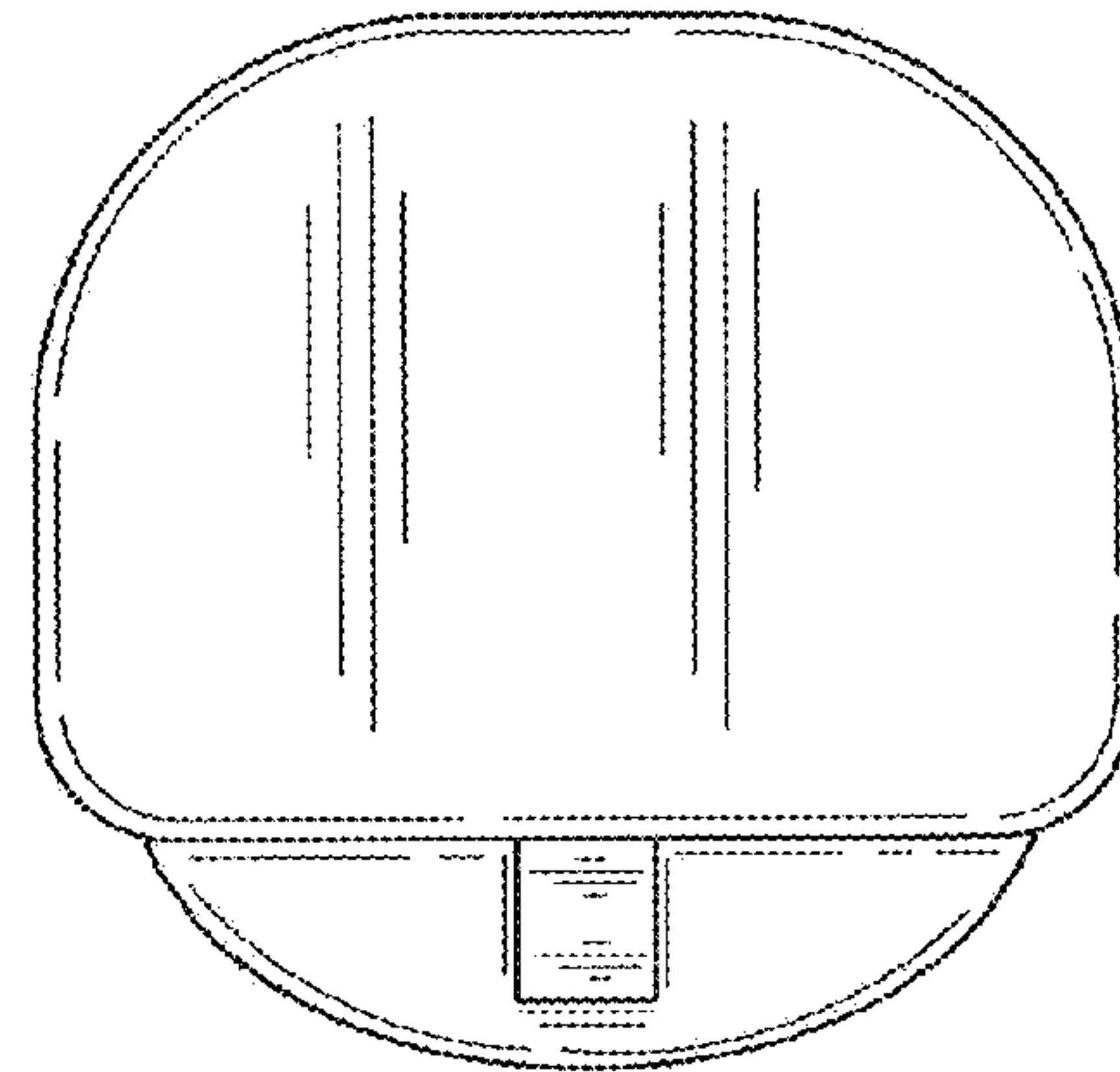

FIG. 55

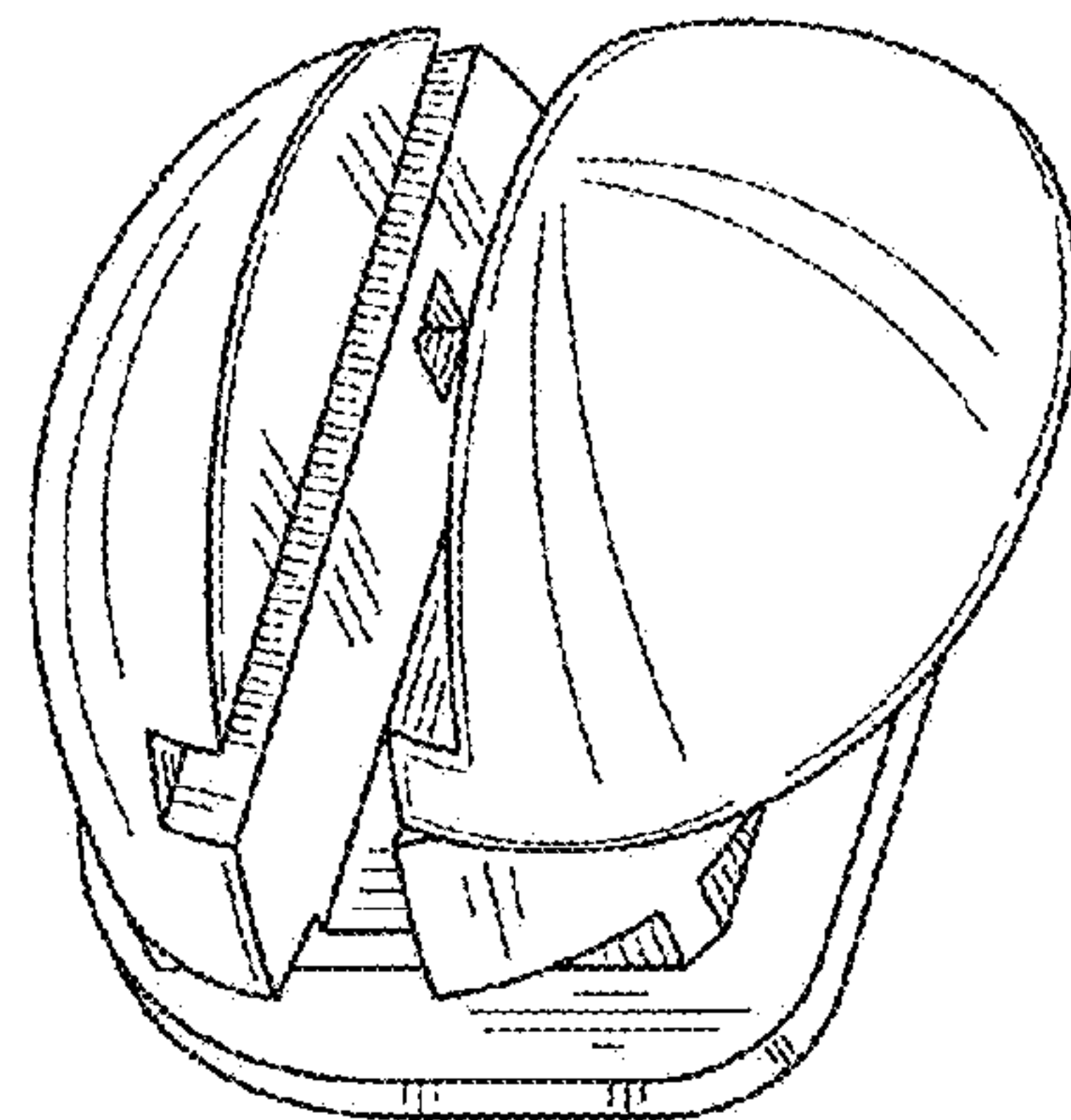

FIG. 56