



US00D747791S

(12) **United States Design Patent**  
**Kaser et al.**

(10) **Patent No.:** **US D747,791 S**  
(45) **Date of Patent:** **\*\* Jan. 19, 2016**

(54) **TWO-TABLET CAPSULE**

(71) Applicant: **Reckitt Benckiser LLC**, Parsippany, NJ (US)

(72) Inventors: **Matthew Kaser**, Parsippany, NJ (US);  
**Raghu Cavatur**, Parsippany, NJ (US);  
**Nils Ahlgren**, Parsippany, NJ (US)

(73) Assignee: **RECKITT BENCKISER LLC**, Parsippany, NJ (US)

(\*\*) Term: **14 Years**

(21) Appl. No.: **29/508,682**

(22) Filed: **Nov. 10, 2014**

(51) **LOC (10) Cl.** ..... **24-01**

(52) **U.S. Cl.**  
USPC ..... **D24/104**

(58) **Field of Classification Search**  
USPC ..... D24/100-104; D1/100, 106, 127  
CPC ..... A61K 9/20; A61K 9/209; A61K 9/2077;  
A61K 9/5078; A61K 9/2081; A61K 9/4891;  
A61K 9/167; A61K 8/11  
See application file for complete search history.

(56) **References Cited**

U.S. PATENT DOCUMENTS

1,419,618 A \* 6/1922 Deming ..... A61J 3/071  
424/438  
1,931,765 A \* 10/1933 Leever ..... A47G 19/16  
206/0.5  
2,102,885 A \* 12/1937 Carroll ..... A45D 40/00  
132/286  
2,340,037 A \* 1/1944 Zipper ..... A61J 3/071  
206/530  
3,844,407 A \* 10/1974 Buie ..... B65D 41/06

206/1.5  
D520,635 S \* 5/2006 Bonny ..... D24/101  
D665,072 S \* 8/2012 Trento ..... D24/104

\* cited by examiner

*Primary Examiner* — Susan Bennett Hattan  
*Assistant Examiner* — Charles Hanson  
(74) *Attorney, Agent, or Firm* — Troutman Sanders LLP;  
Ryan A. Schneider; Troy S. Kleckley

(57) **CLAIM**

The ornamental designs for two-tablet capsule, as shown and described.

**DESCRIPTION**

FIG. 1 is a perspective view of a two-tablet capsule of the present invention;  
FIG. 2 is a top view of the capsule of FIG. 1, the bottom view being a mirror image thereof;  
FIG. 3 is a side view of the capsule of FIG. 1, the other side view being a mirror image thereof;  
FIG. 4 is a front view of the capsule of FIG. 1;  
FIG. 5 is a back view of the capsule of FIG. 1;  
FIG. 6 is a perspective view of a second embodiment thereof;  
FIG. 7 is a top view of the capsule of FIG. 6, the bottom view being a mirror image thereof;  
FIG. 8 is a side view of the capsule of FIG. 6, the other side view being a mirror image thereof;  
FIG. 9 is a front view of the capsule of FIG. 6;  
FIG. 10 is a back view of the capsule of FIG. 6;  
FIG. 11 is a perspective view of a third embodiment thereof;  
FIG. 12 is top view of the capsule of FIG. 11, the bottom view being a mirror image thereof;  
FIG. 13 is a side view of the capsule of FIG. 11, the other side view being a mirror image thereof;  
FIG. 14 is a front view of the capsule of FIG. 11; and,  
FIG. 15 is a back view of the capsule of FIG. 11.

**1 Claim, 15 Drawing Sheets**

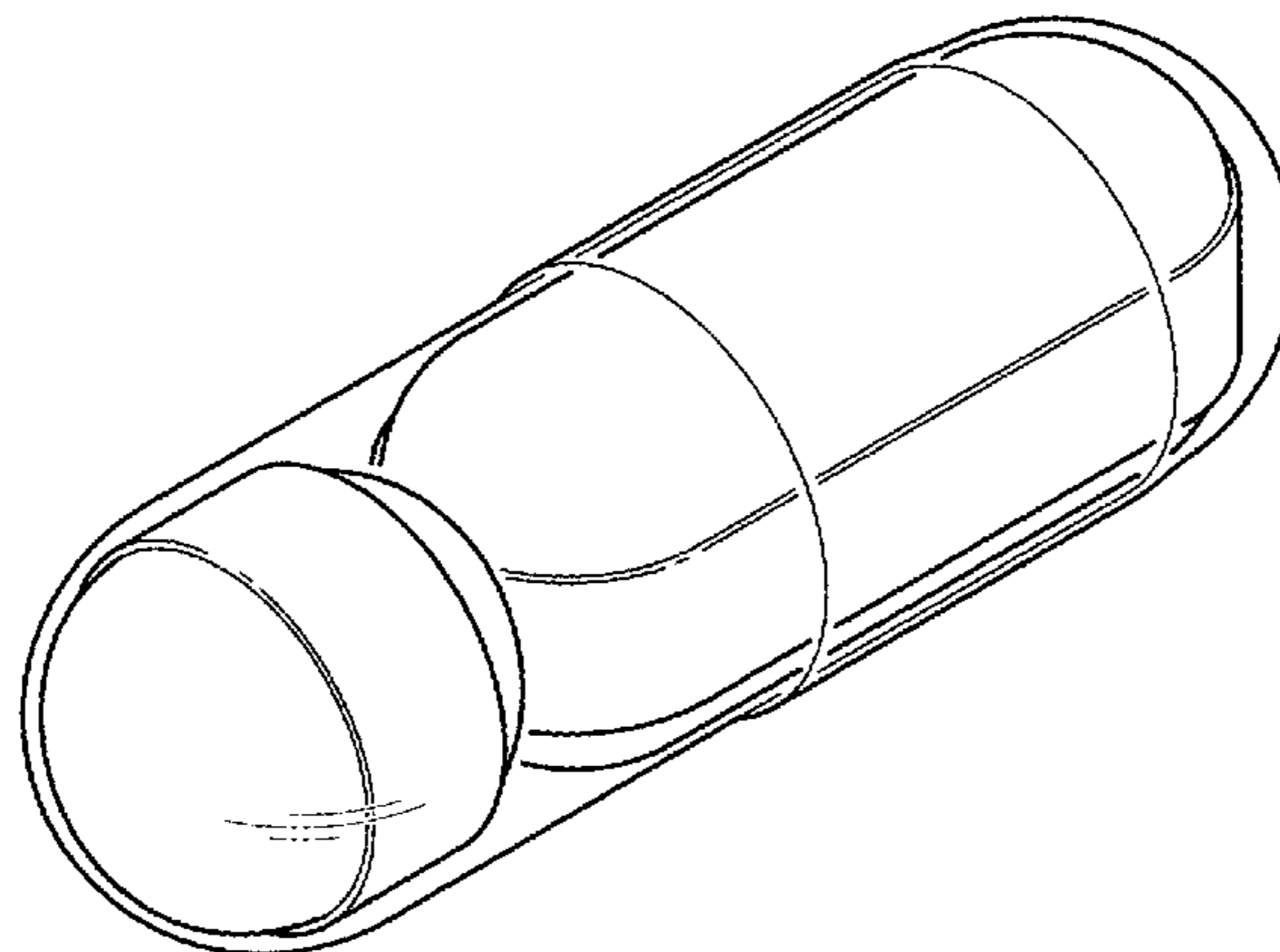

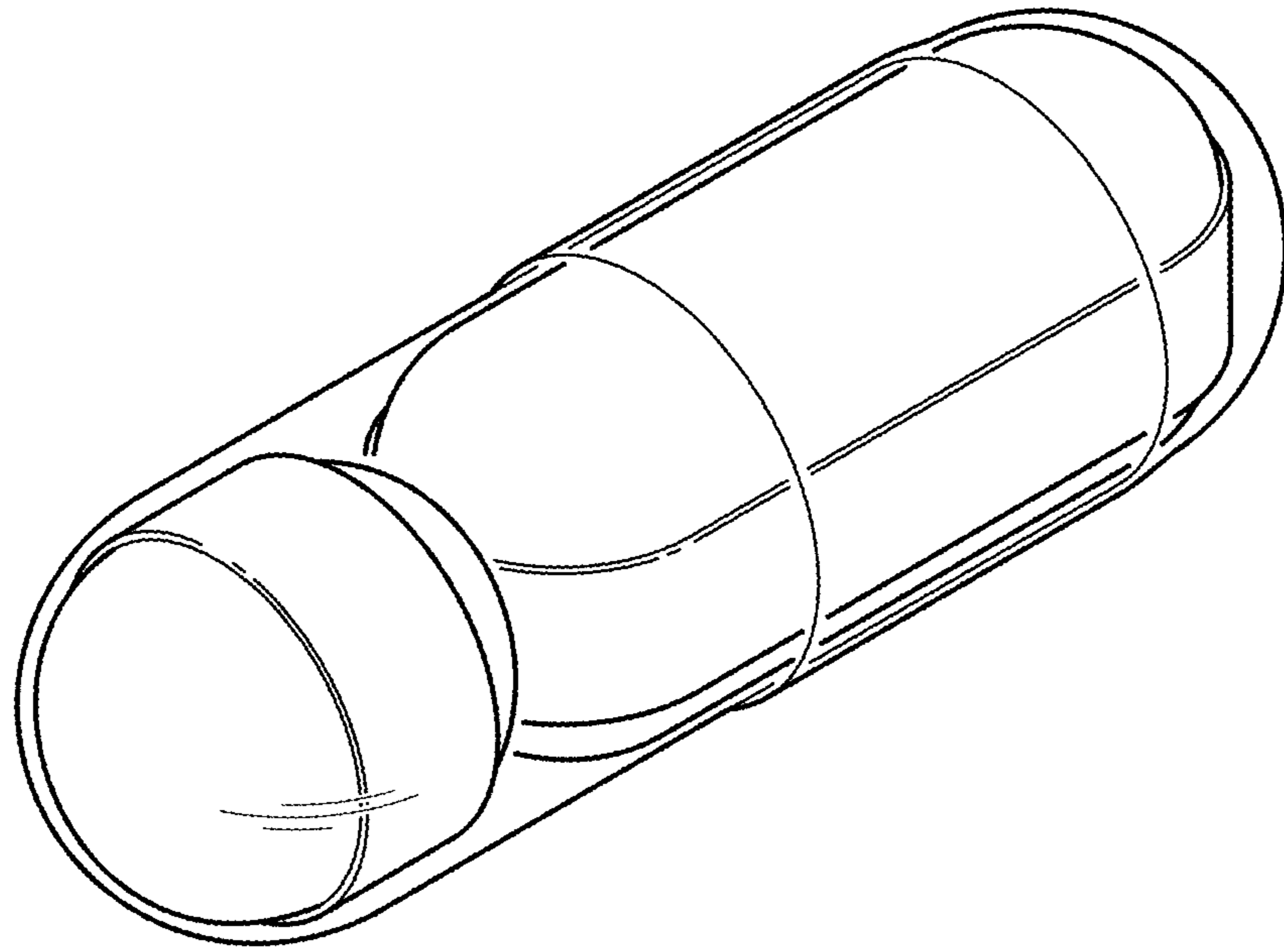

FIG. 1

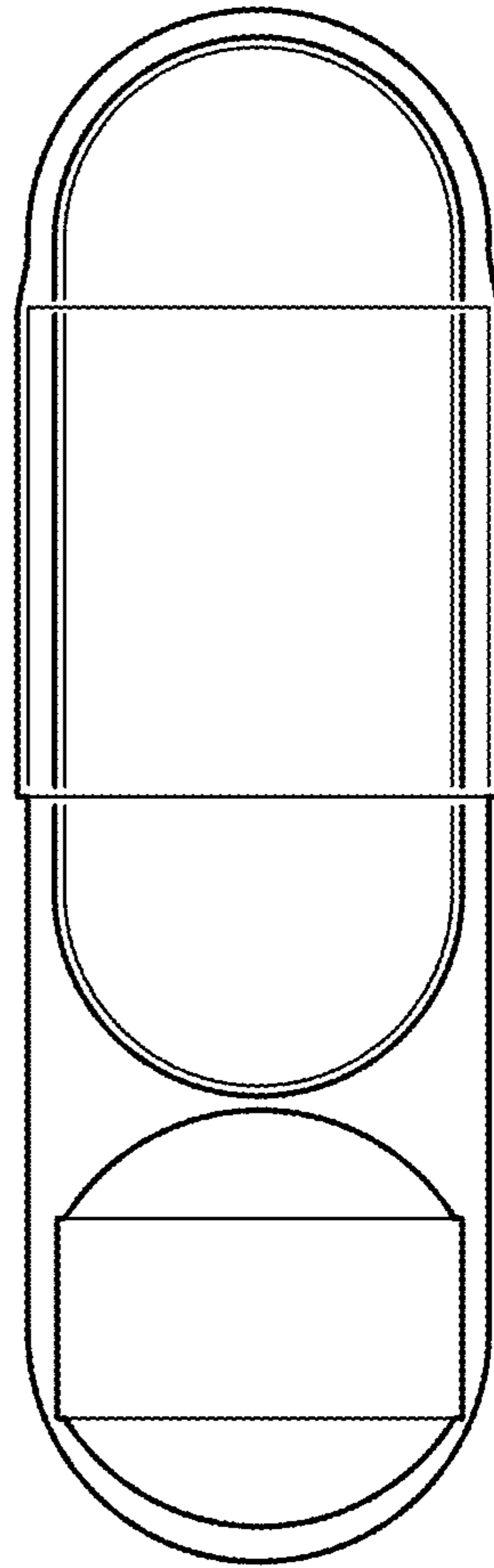

FIG. 2

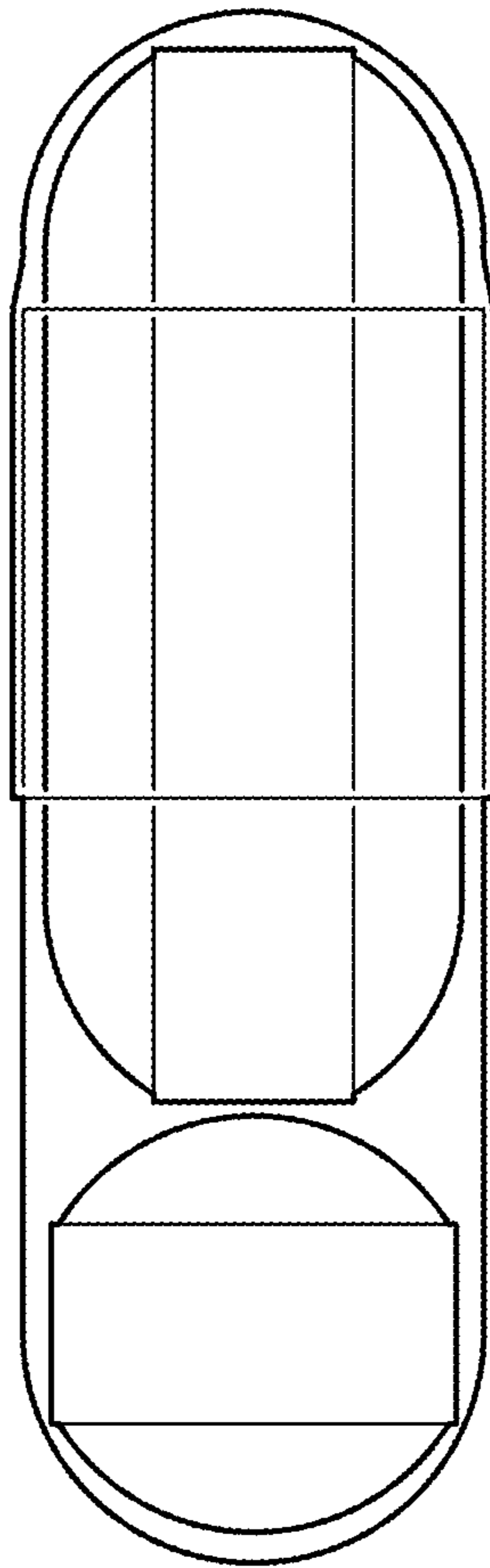

FIG. 3

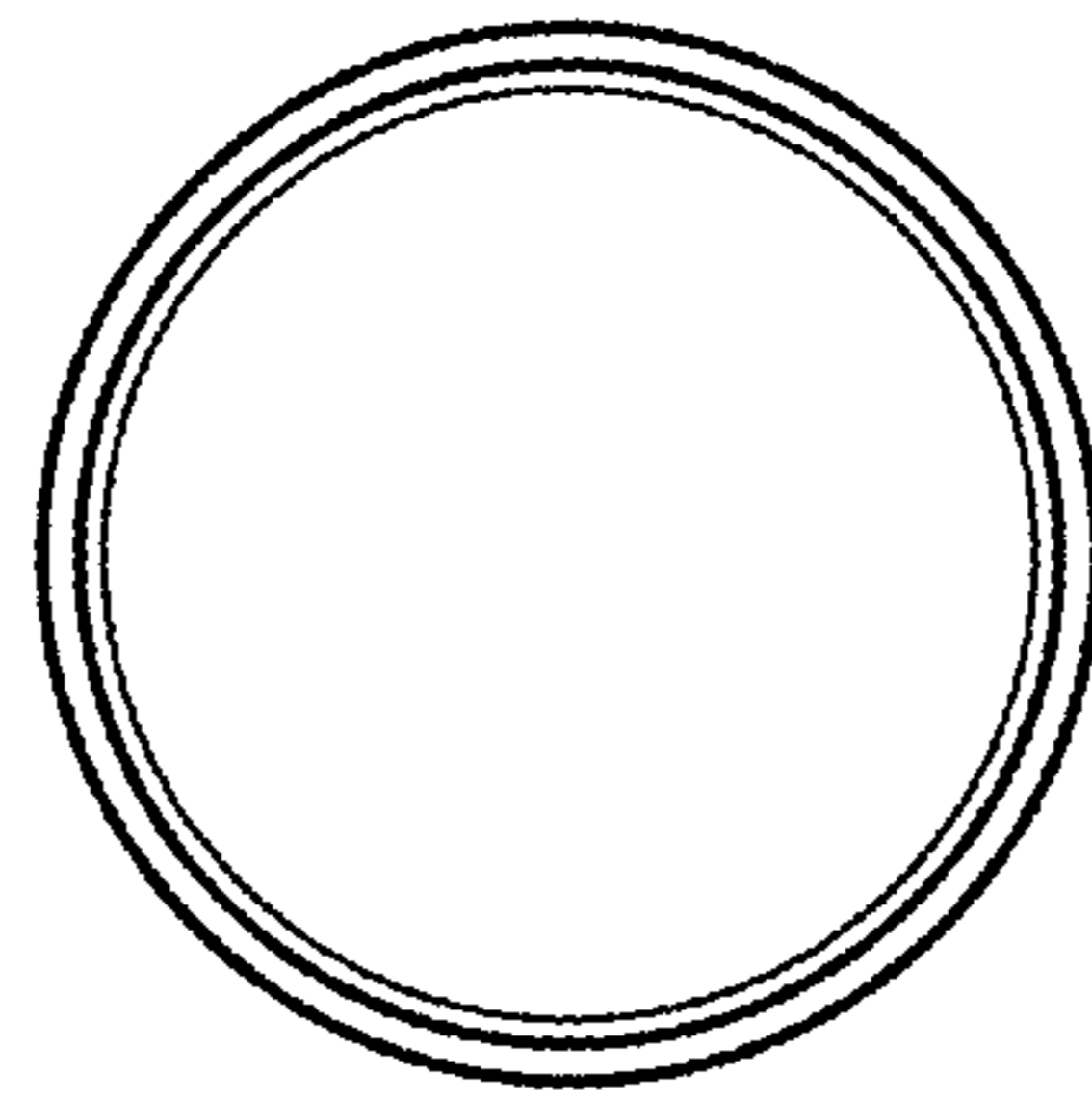

FIG. 4

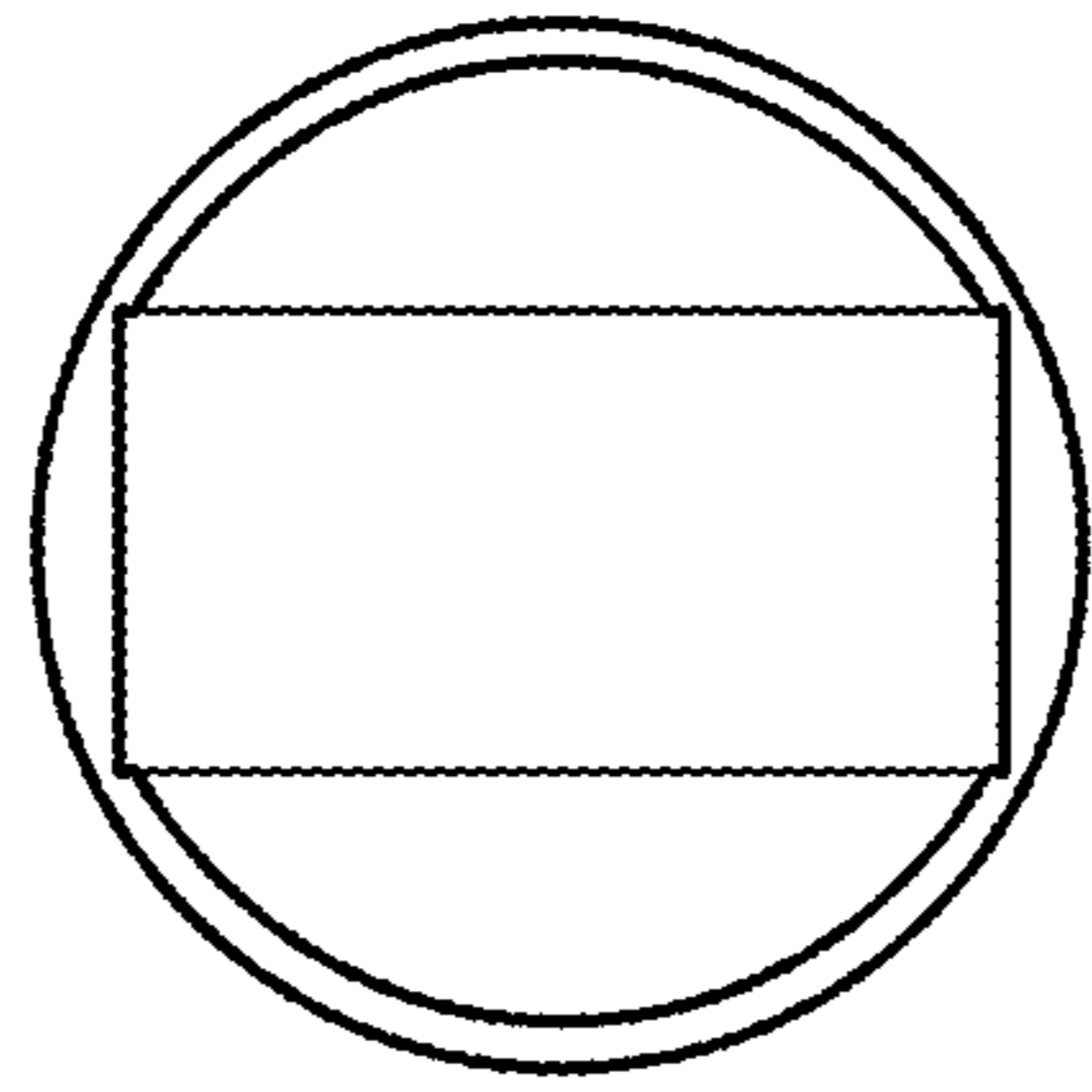

FIG. 5

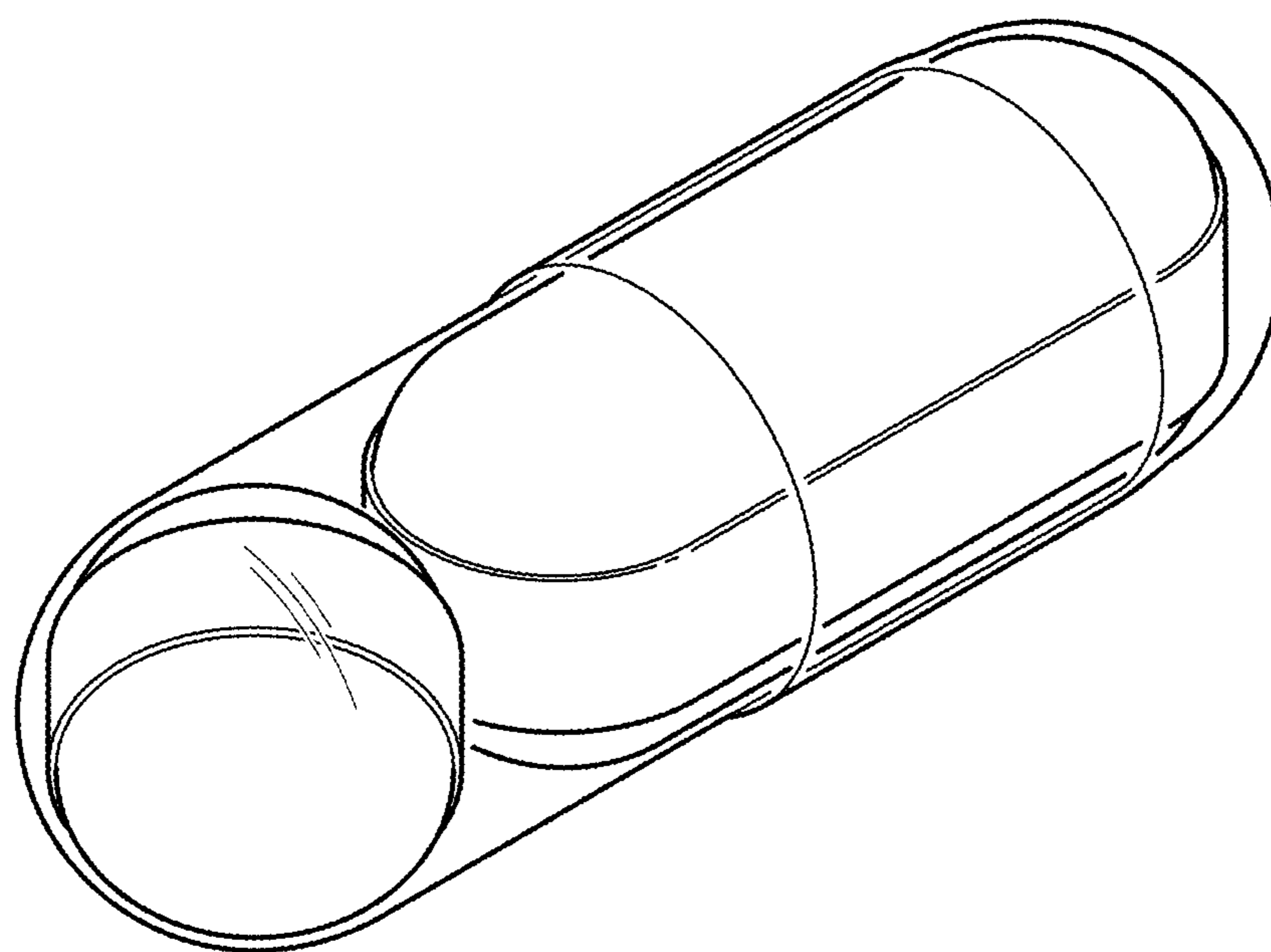

FIG. 6

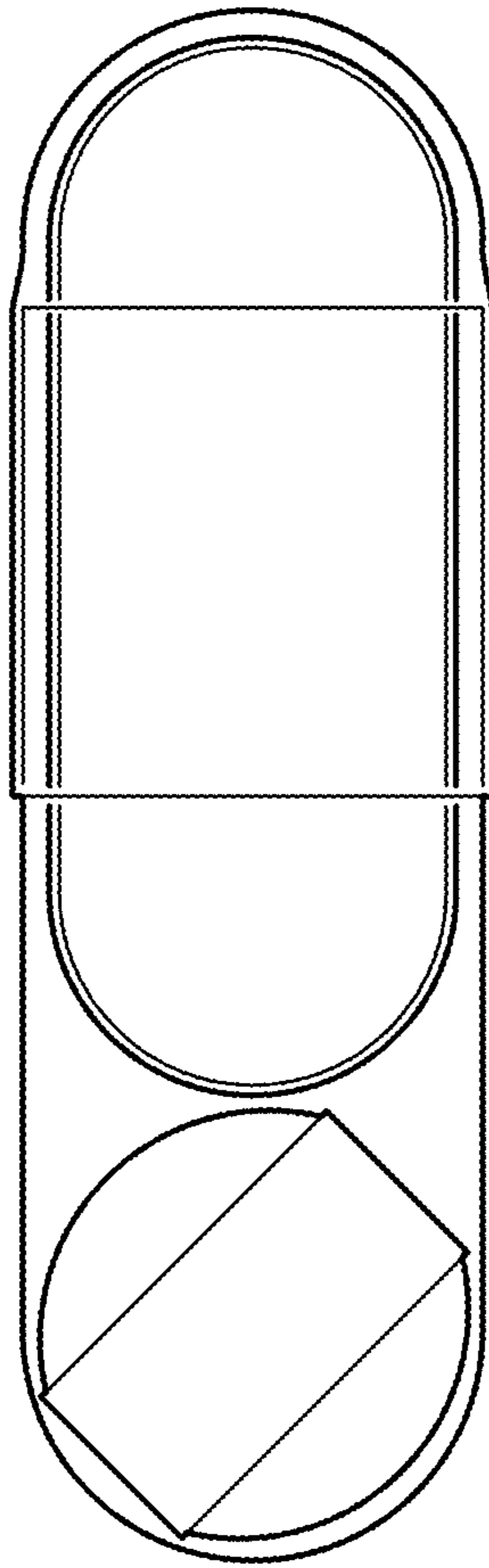

FIG. 7



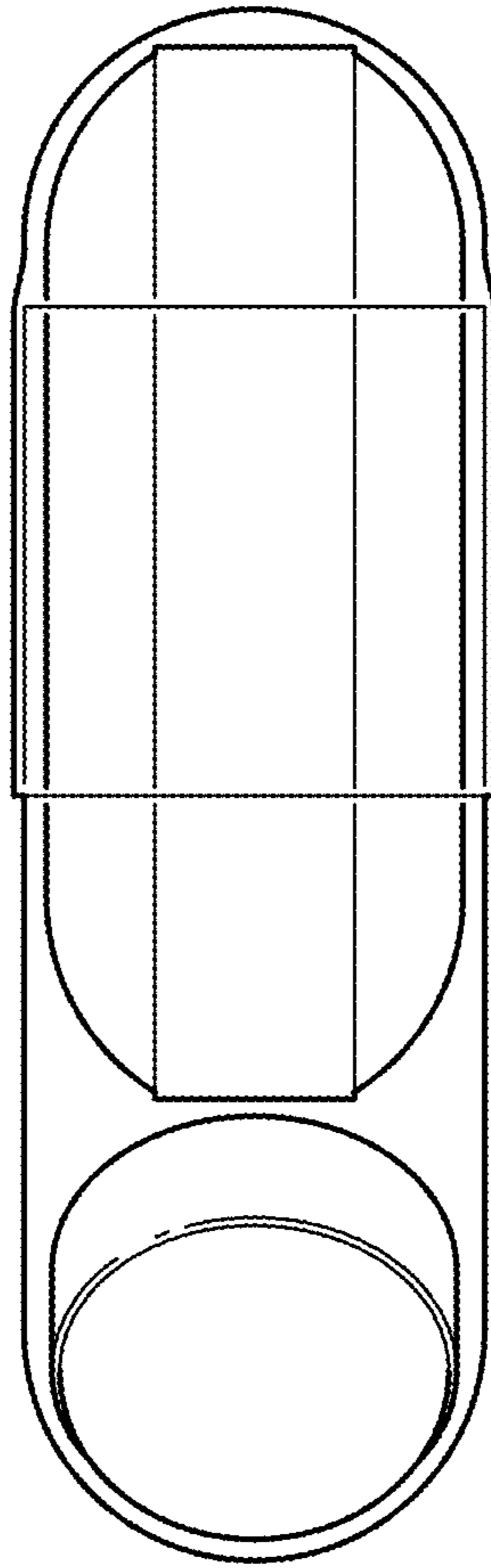

FIG. 8

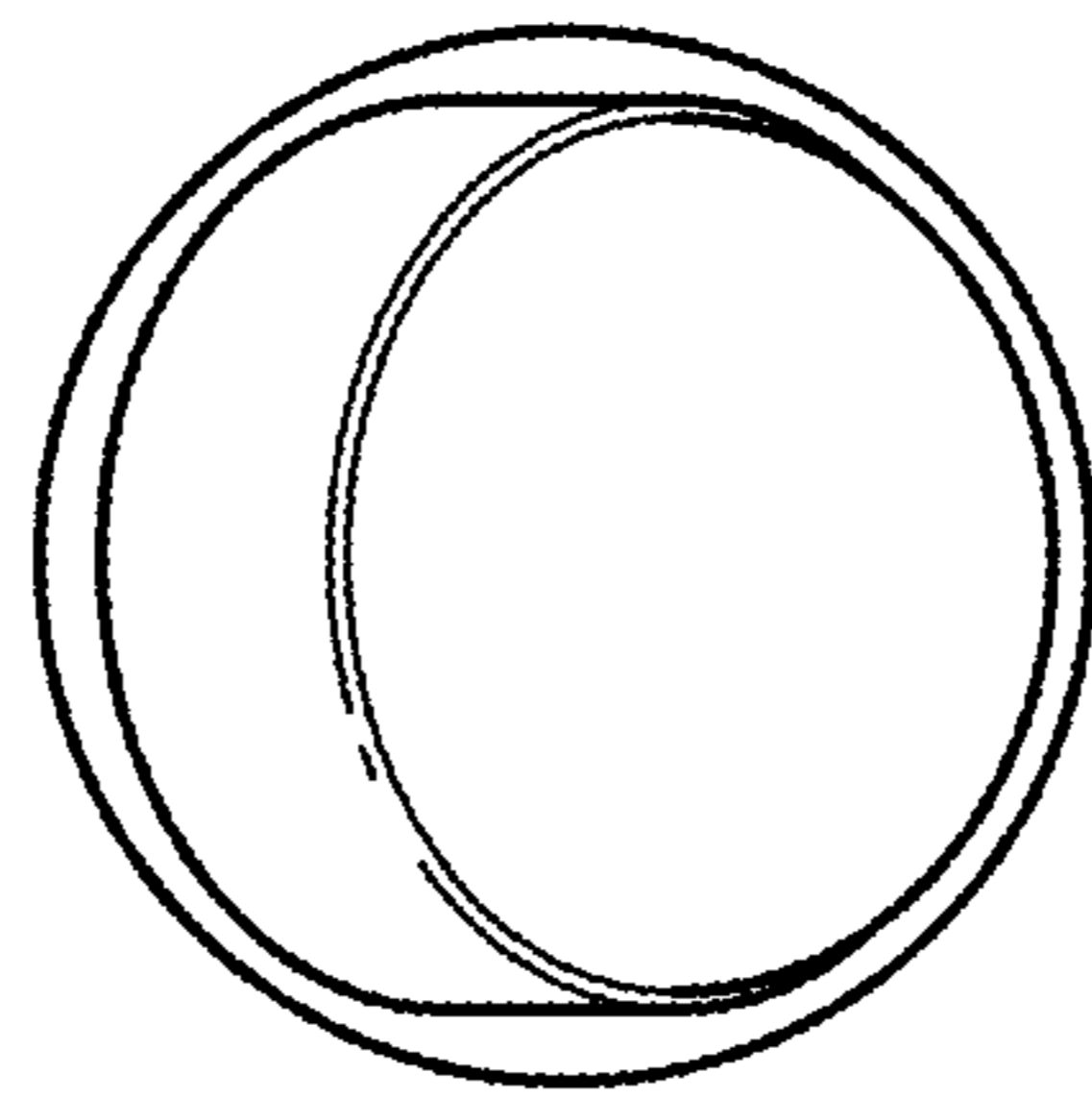

FIG. 9

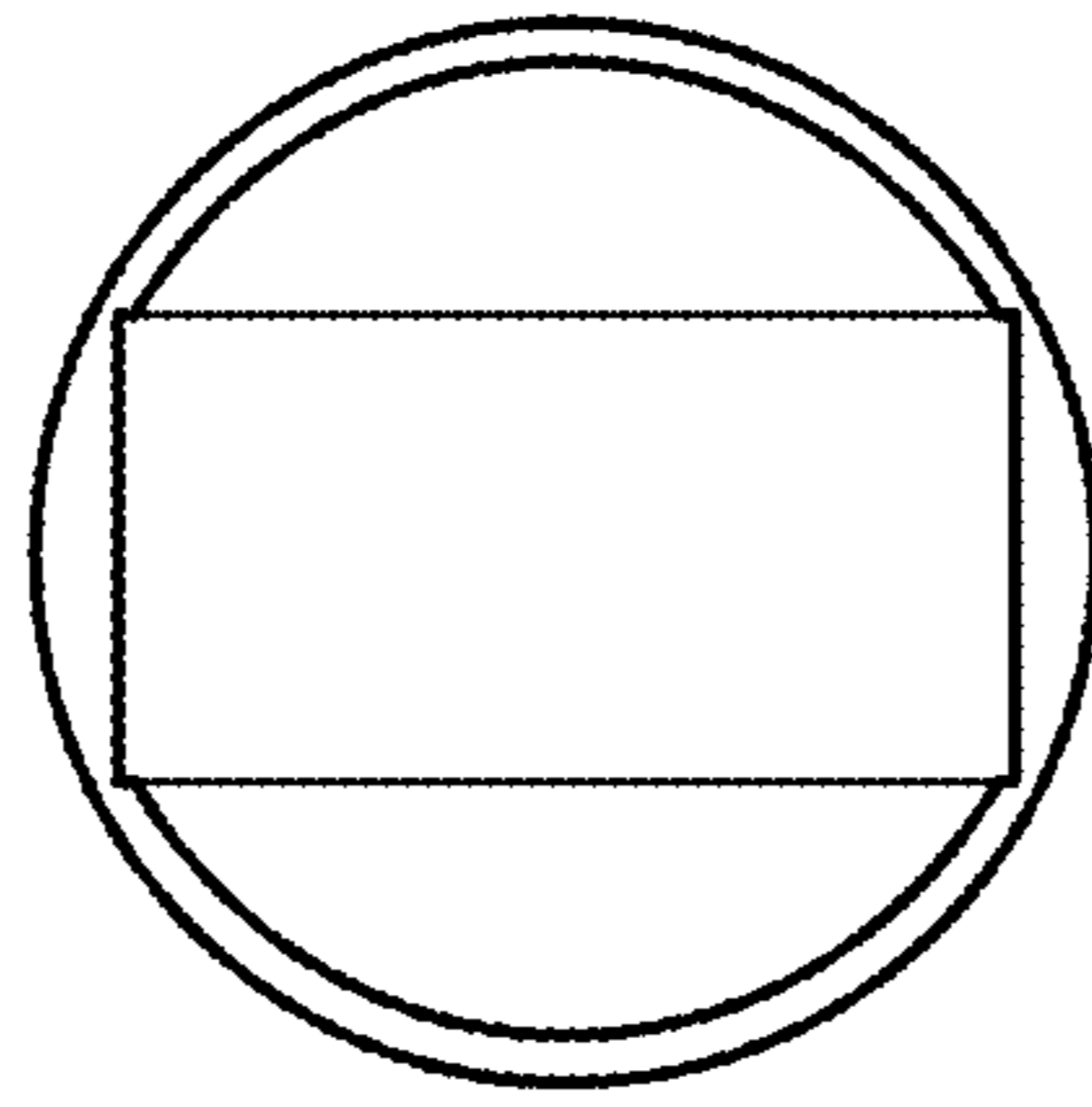

FIG. 10

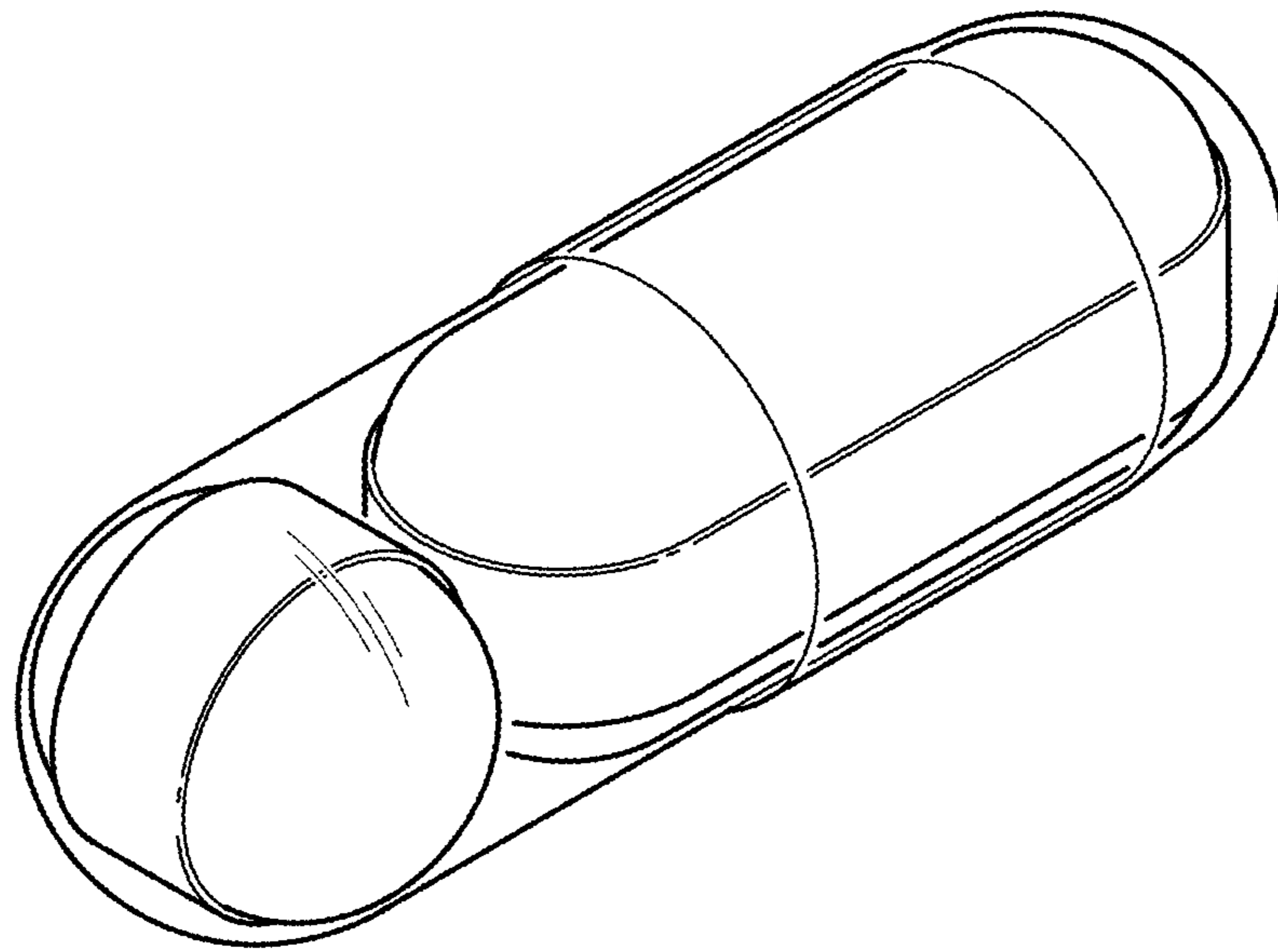

FIG. 11

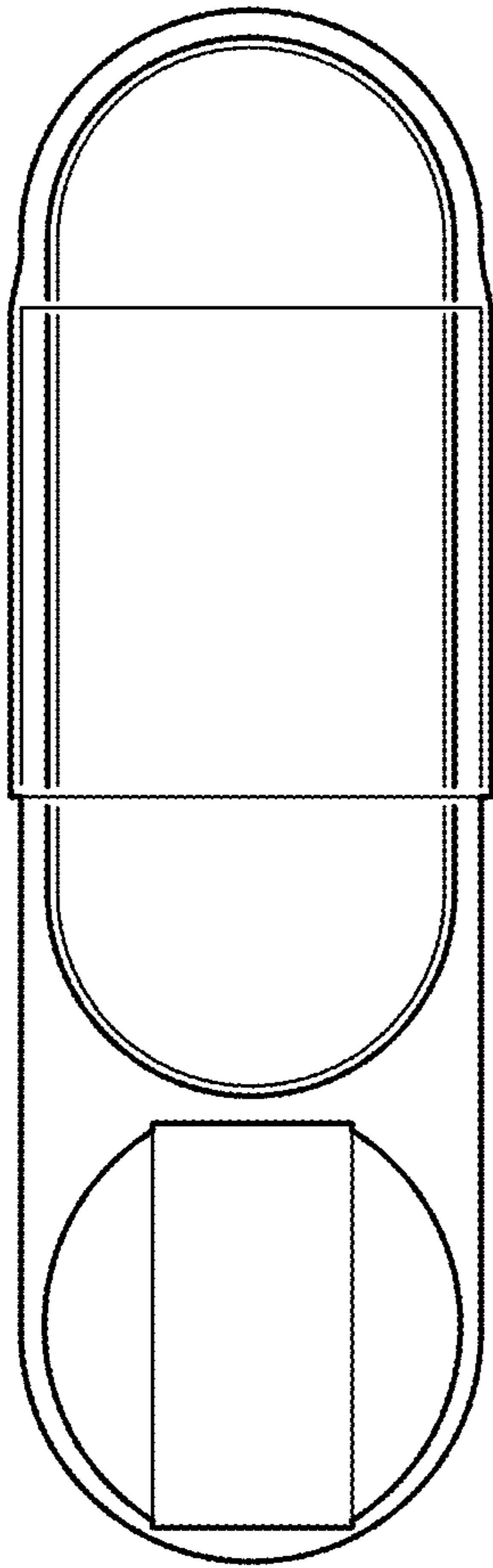

FIG. 12

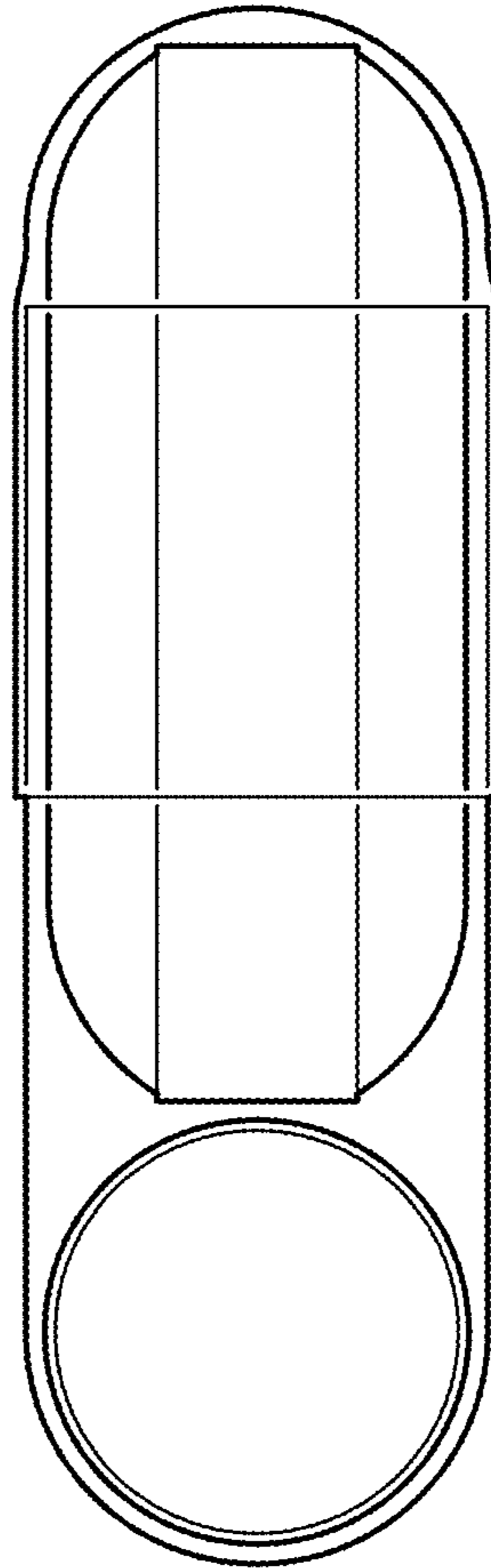

FIG. 13

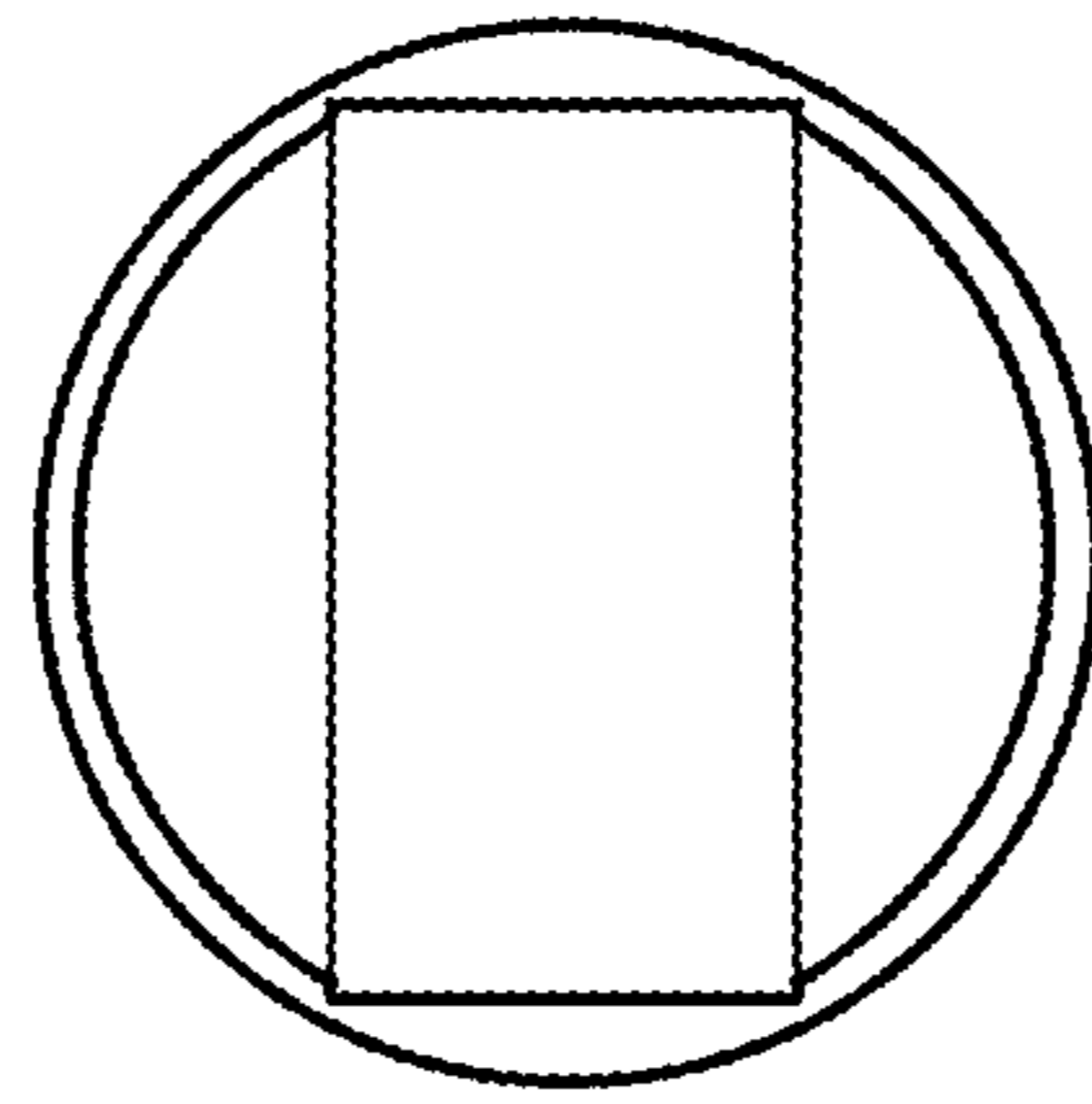

FIG. 14

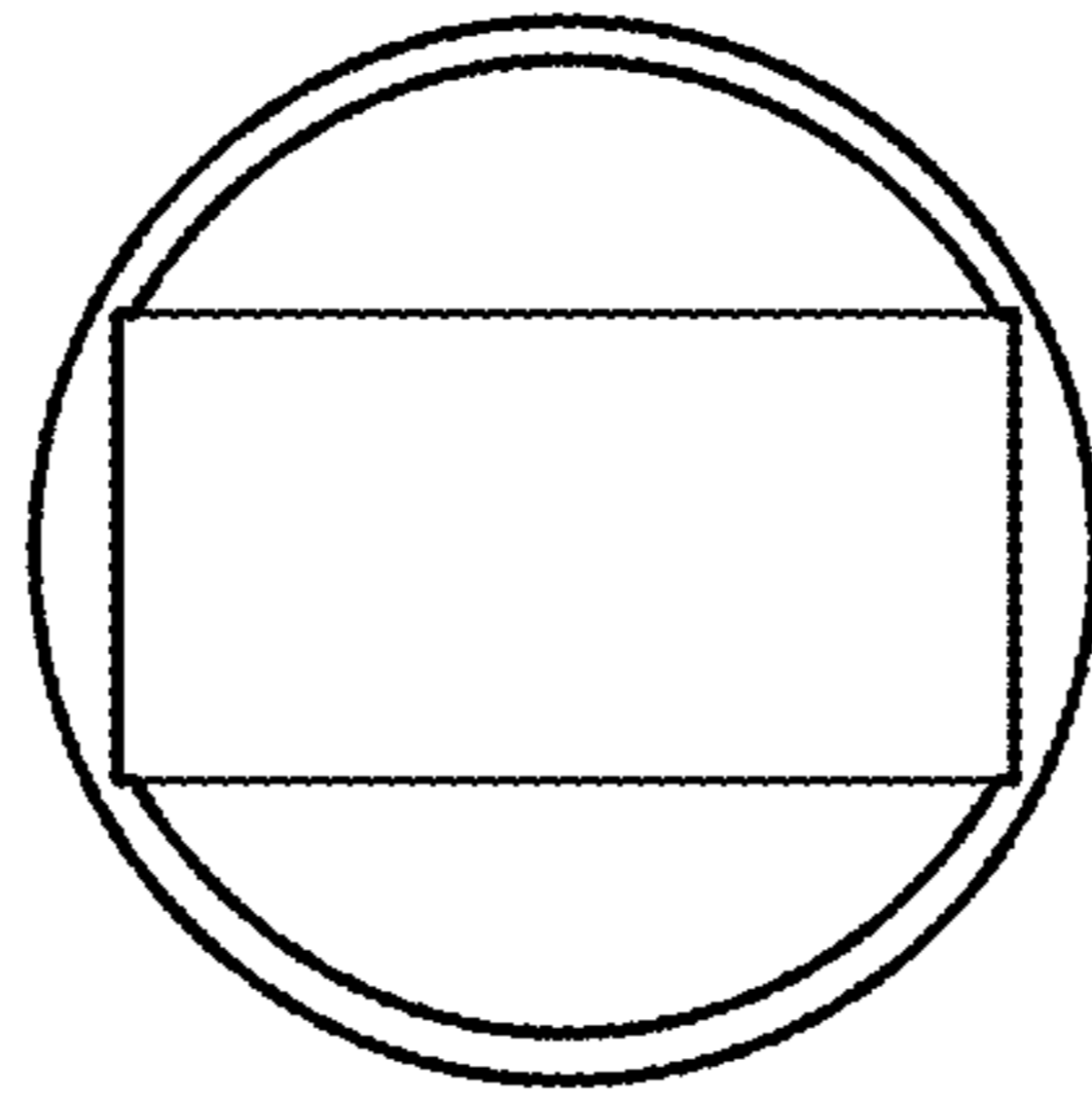

FIG. 15