



US00D747753S

(12) **United States Design Patent**  
**Hanneken**

(10) **Patent No.:** **US D747,753 S**  
(45) **Date of Patent:** **\*\* Jan. 19, 2016**

(54) **TIRE CHANGER MOUNTING HEAD**

(71) Applicant: **Hunter Engineering Company**, St. Louis, MO (US)

(72) Inventor: **Douglas S. Hanneken**, St. Louis, MO (US)

(73) Assignee: **Hunter Engineering Company**, St. Louis, MO (US)

(\*\*) Term: **14 Years**

(21) Appl. No.: **29/504,204**

(22) Filed: **Oct. 2, 2014**

(51) **LOC (10) Cl.** ..... **15-99**

(52) **U.S. Cl.**  
USPC ..... **D15/199**

(58) **Field of Classification Search**  
USPC ..... D15/122, 145-147, 199, 131, 10,  
D15/127-129; 157/1.17, 1.24  
CPC ..... B60C 25/132-25/138  
See application file for complete search history.

(56) **References Cited**

**U.S. PATENT DOCUMENTS**

5,244,029	A *	9/1993	Schoen	.....	B60C 25/132 157/1.17
6,182,736	B1 *	2/2001	Cunningham	.....	B60C 25/135 157/1.17
6,453,971	B2 *	9/2002	Vignoli	.....	B60C 25/138 157/1.22
D535,313	S *	1/2007	Cunningham	.....	D15/199

9,067,467	B2 *	6/2015	Corgi	.....	B60C 25/0578
2003/0094244	A1 *	5/2003	Gonzaga	.....	B60C 25/13 157/1.3
2009/0101287	A1 *	4/2009	Gonzaga	.....	B60C 25/0551 157/1.17
2010/0089538	A1 *	4/2010	Bonacini	.....	B60C 25/0578 157/1.22
2013/0139973	A1 *	6/2013	Bonacini	.....	B60C 25/132 157/1.24
2013/0306245	A1 *	11/2013	White	.....	B60C 25/13 157/1.17

\* cited by examiner

*Primary Examiner* — Susan Bennett Hattan

*Assistant Examiner* — Brett Miller

(74) *Attorney, Agent, or Firm* — Polster, Lieder, Woodruff & Lucchesi

(57) **CLAIM**

The ornamental design for tire changer mounting head, as shown and described.

**DESCRIPTION**

FIG. 1 is a front perspective view of the tire changer mounting head;  
FIG. 2 is a rear perspective view thereof;  
FIG. 3 is front elevational view thereof;  
FIG. 4 a rear elevational view thereof;  
FIG. 5 is a right side elevational view thereof;  
FIG. 6 is a left side elevational view thereof;  
FIG. 7 is a top plan view thereof; and,  
FIG. 8 is a bottom plan view thereof.  
The broken lines depict portions of the tire changer mounting head that form not part of the claim.

**1 Claim, 8 Drawing Sheets**

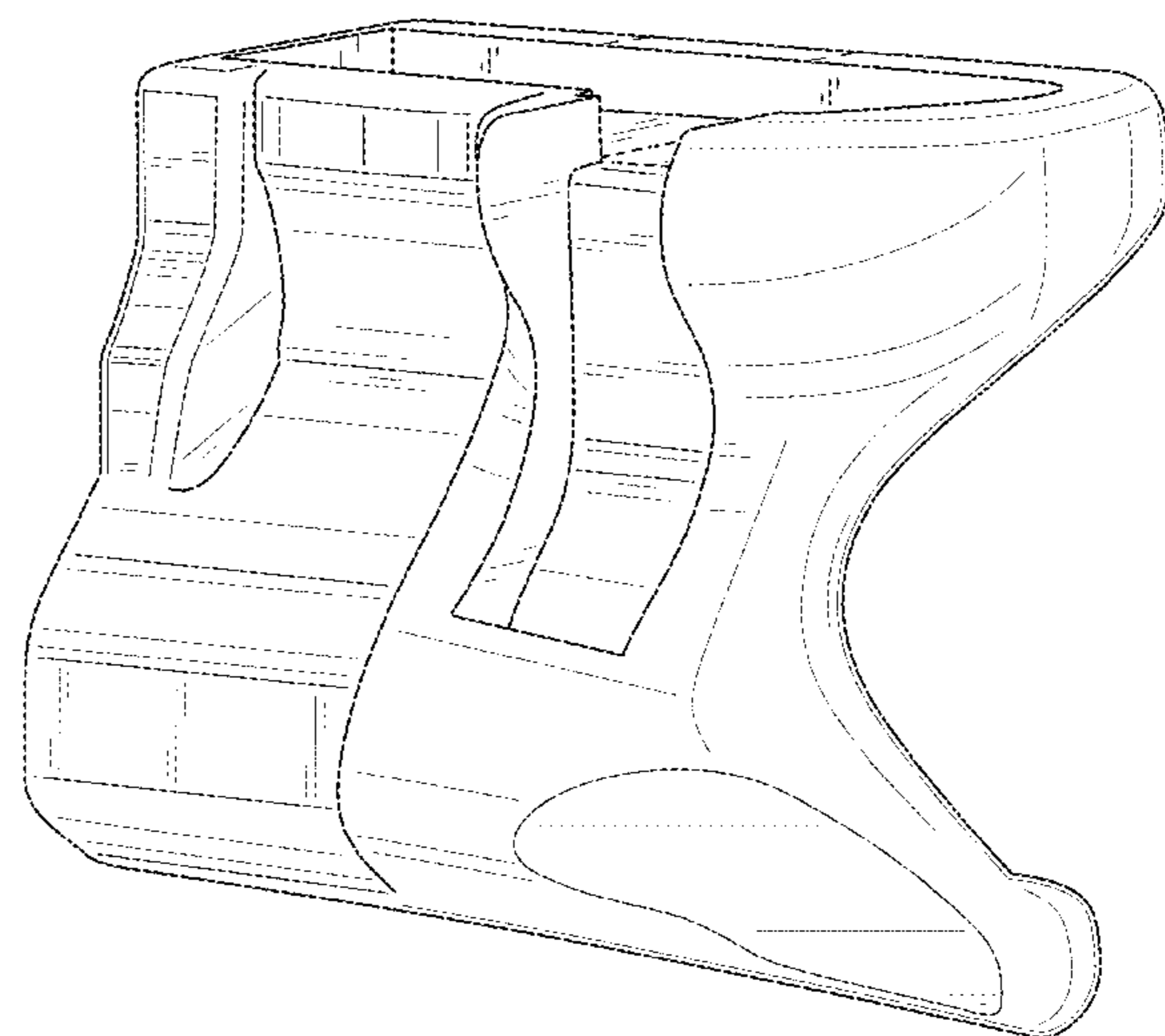
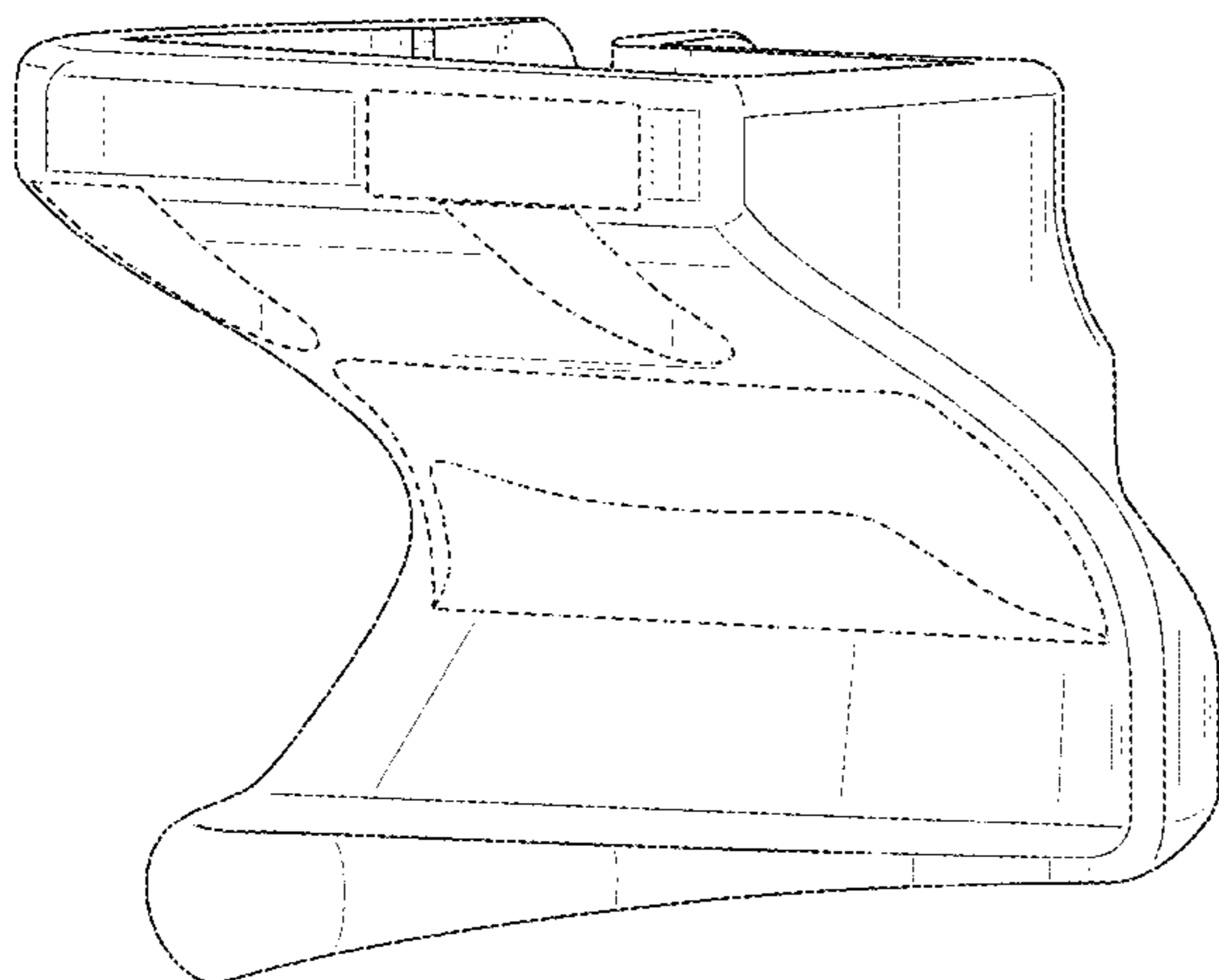

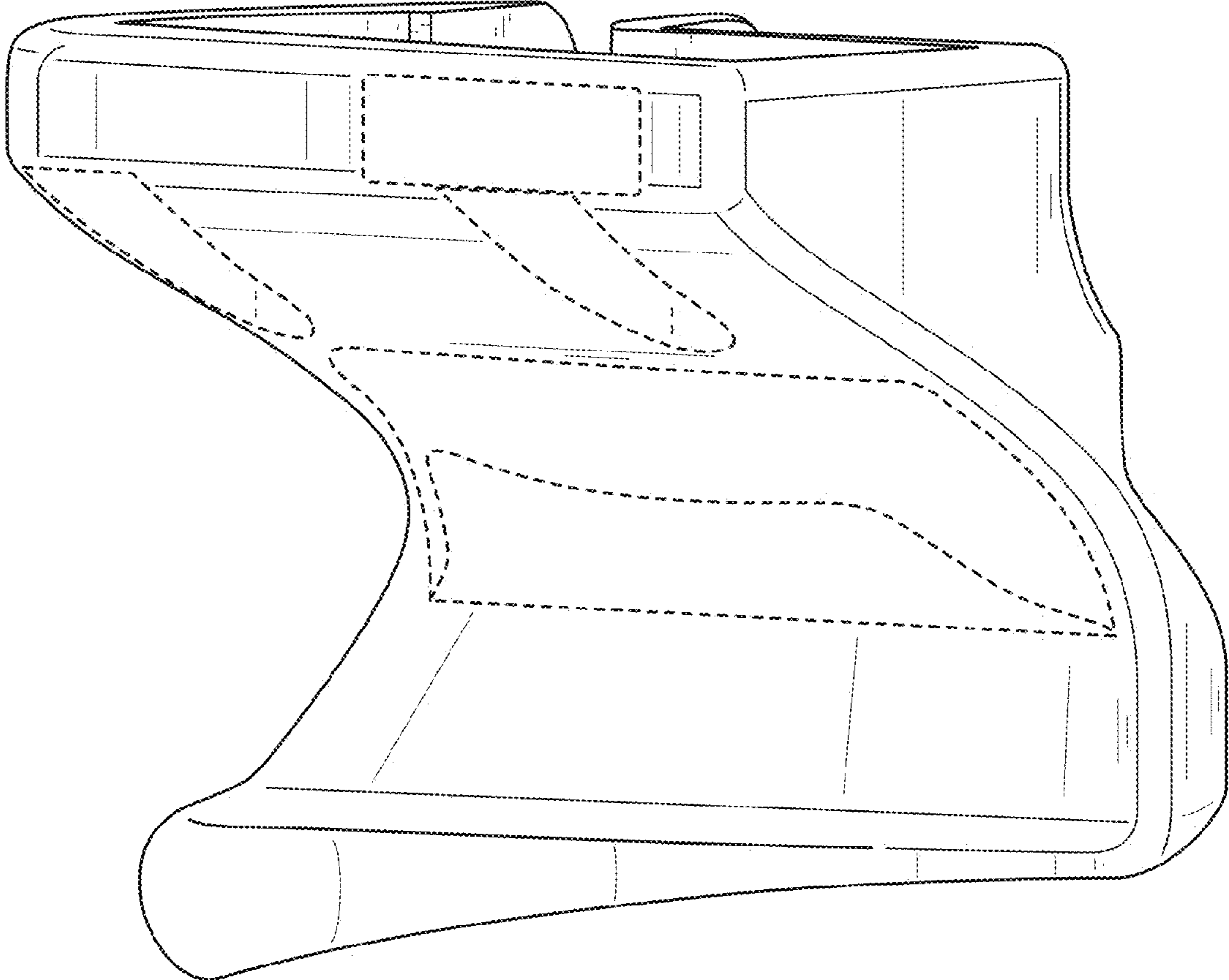

FIG. 1

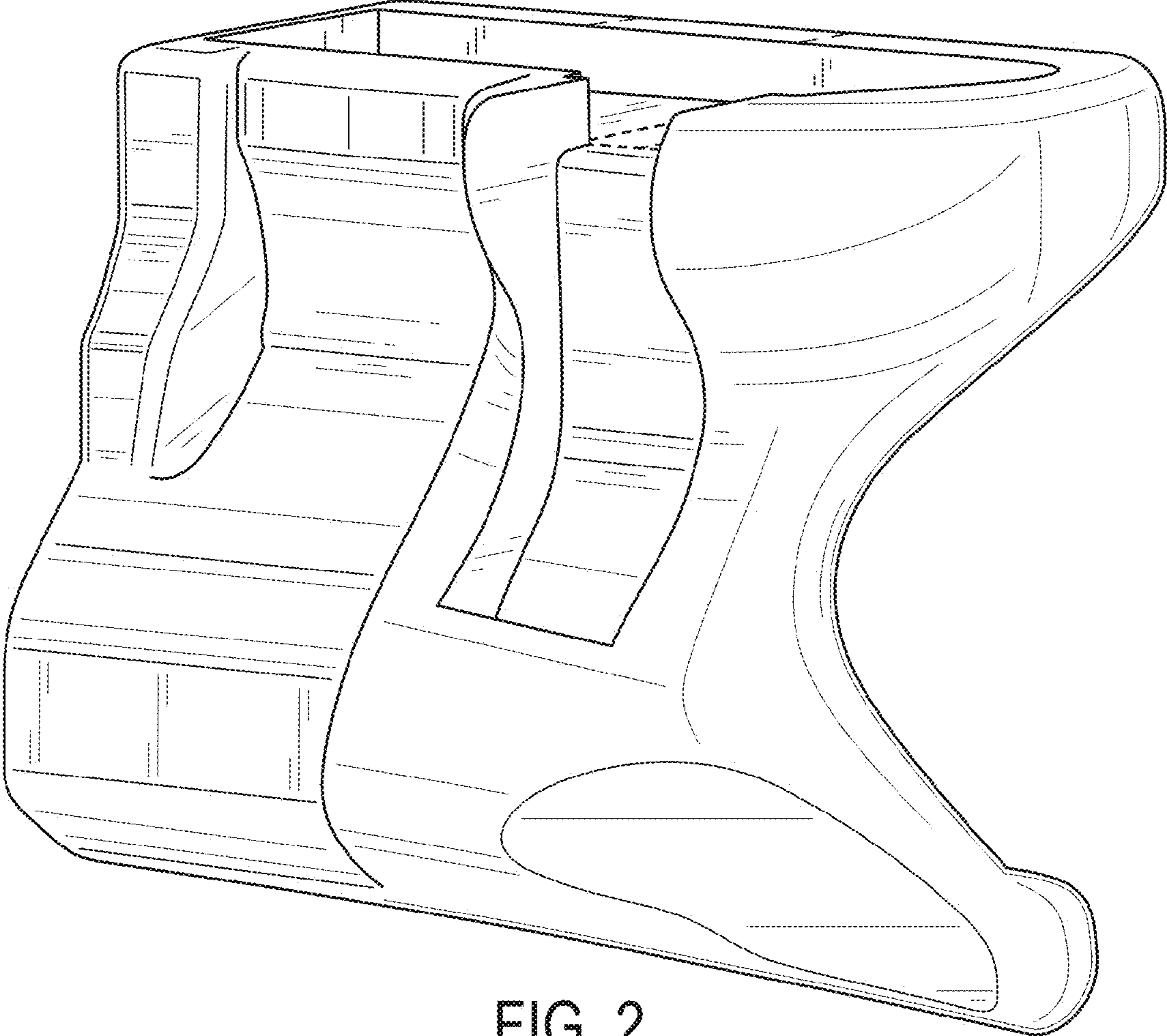

FIG. 2

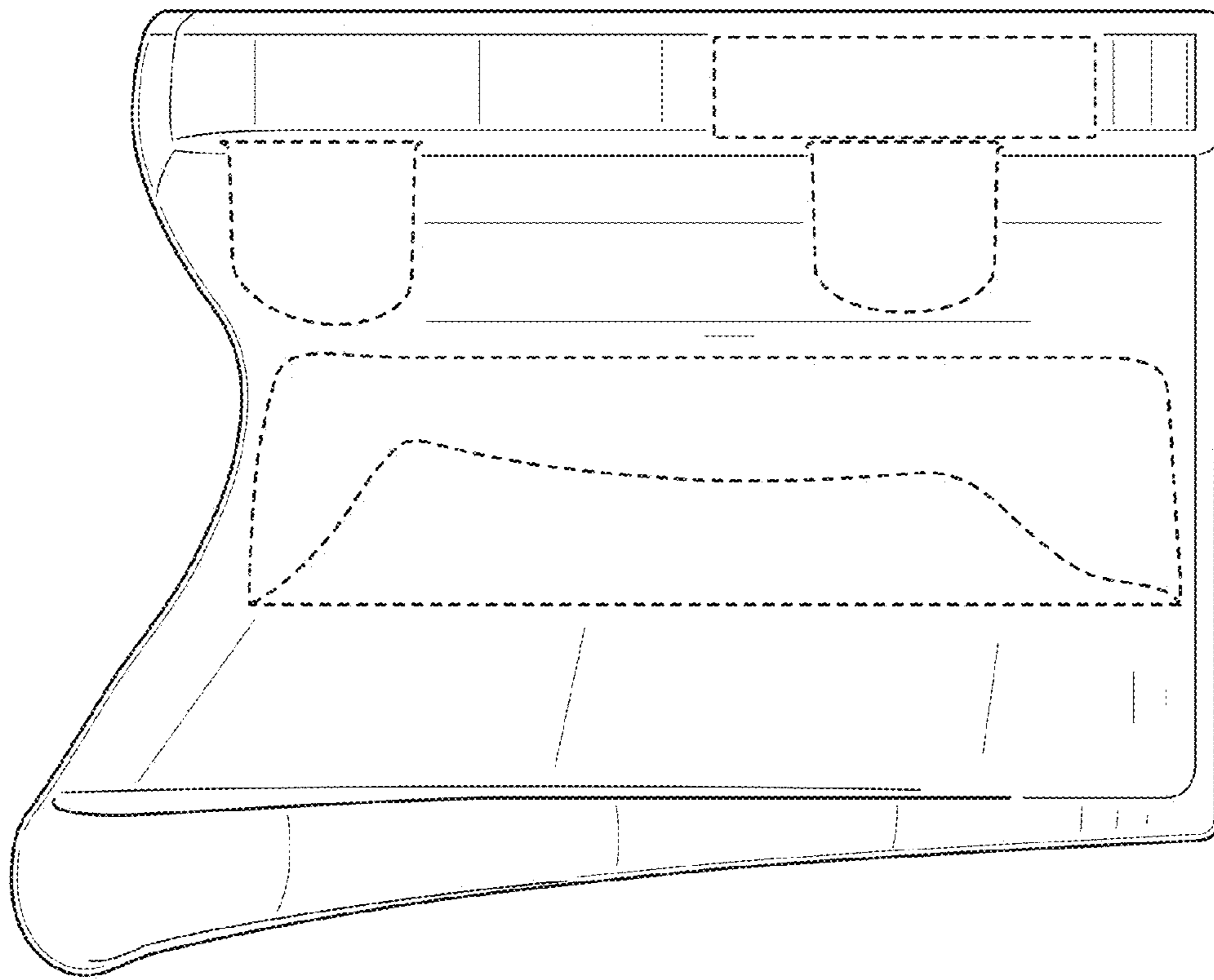

FIG. 3

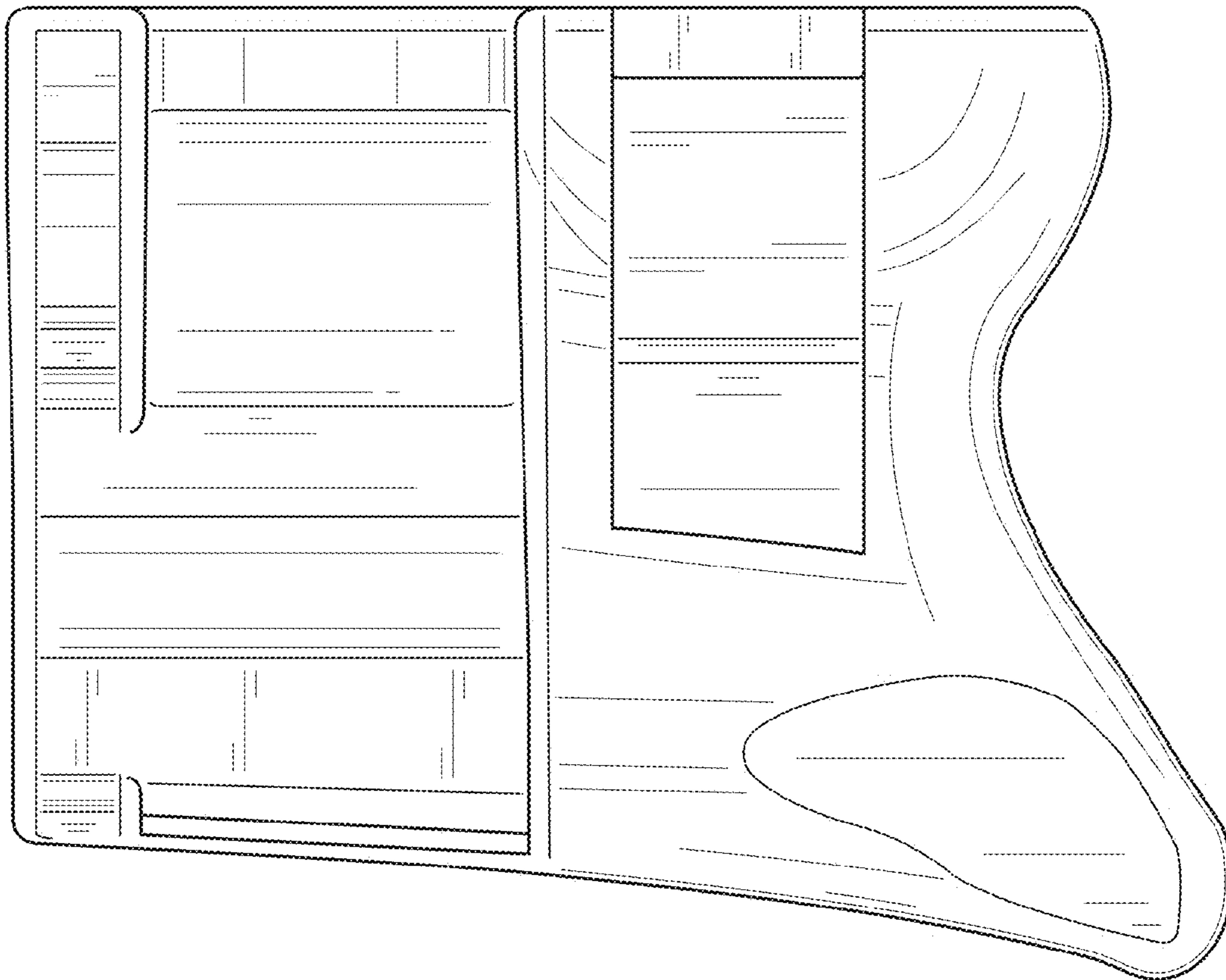

FIG. 4

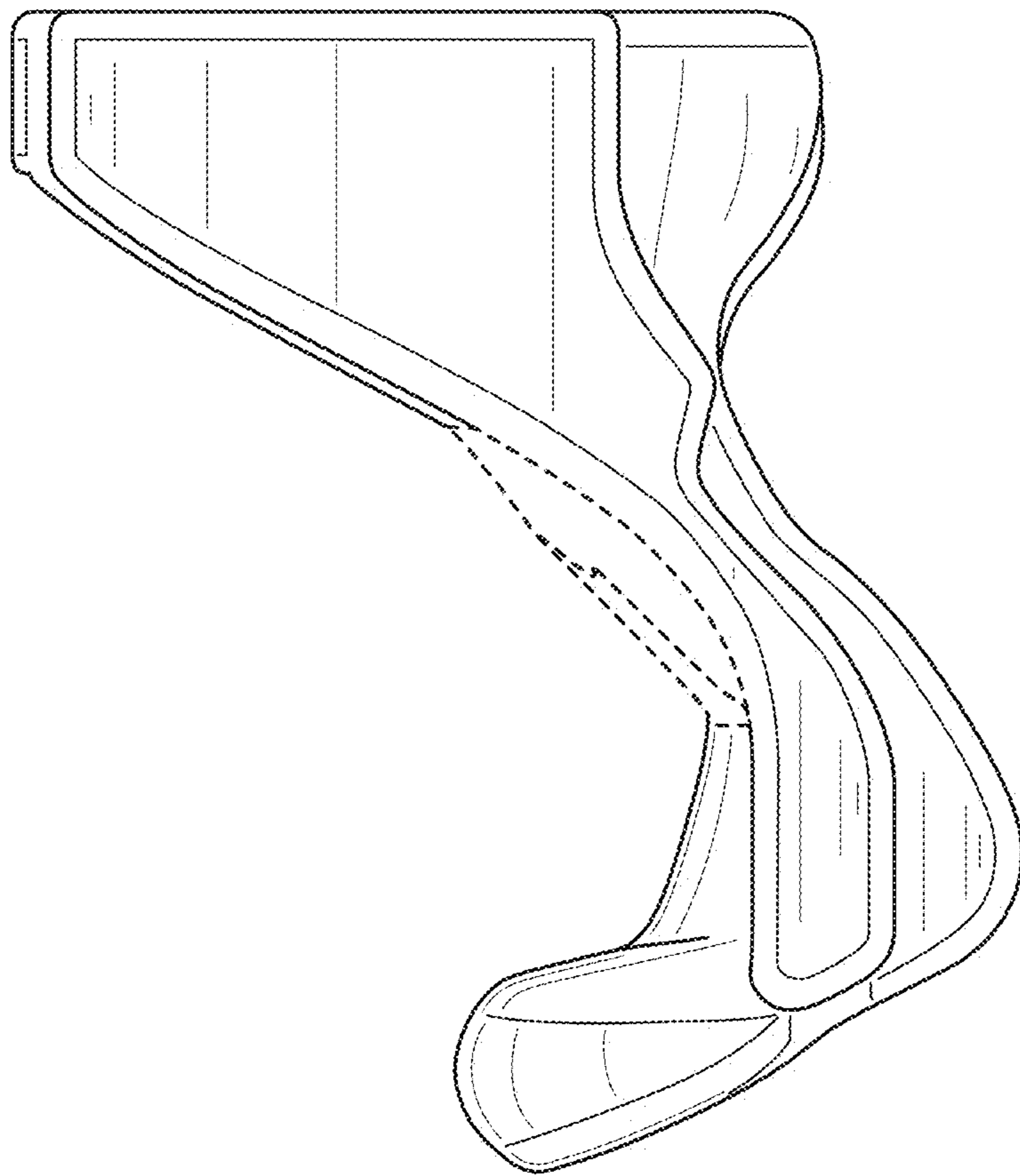

FIG. 5

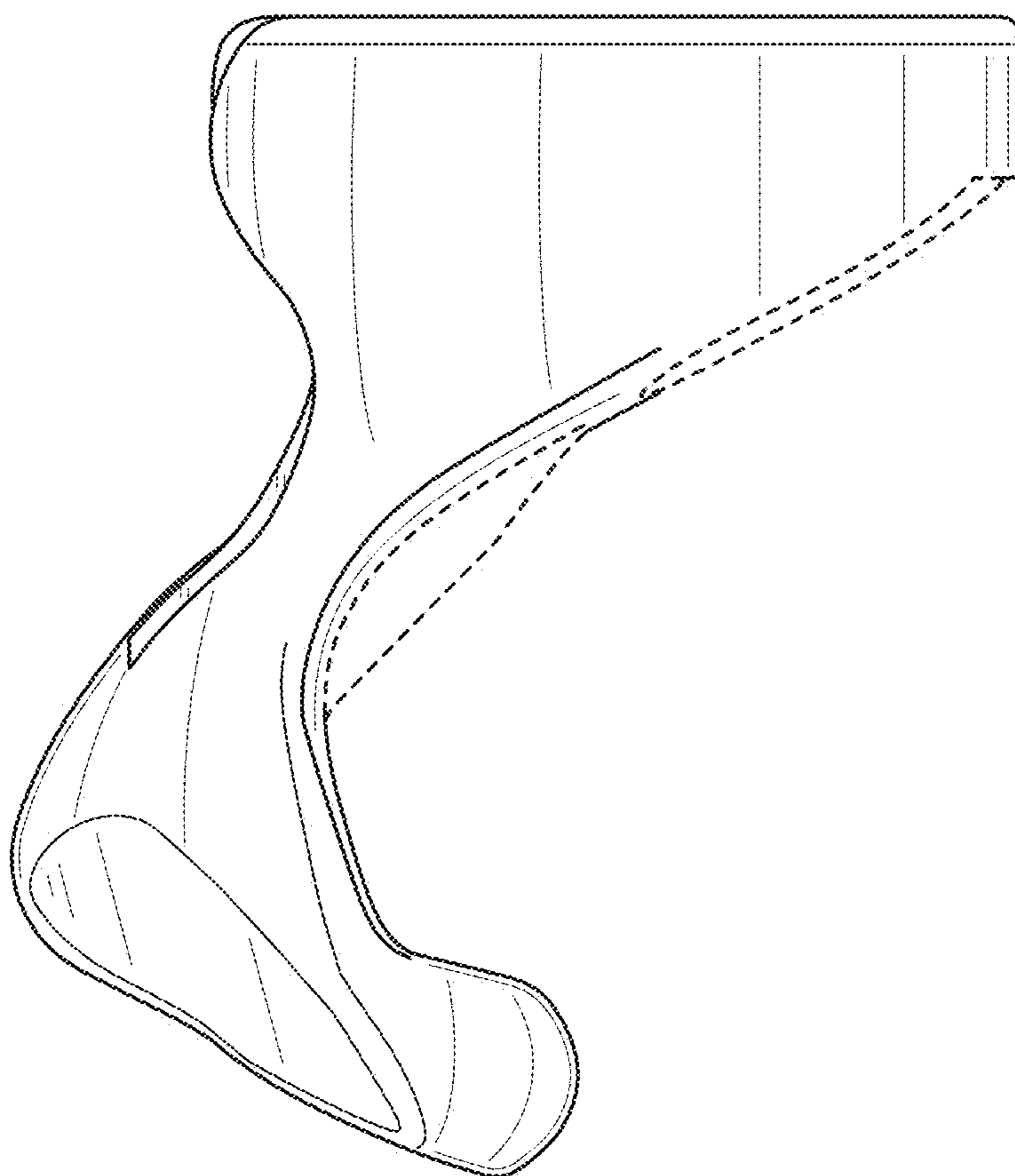

FIG. 6

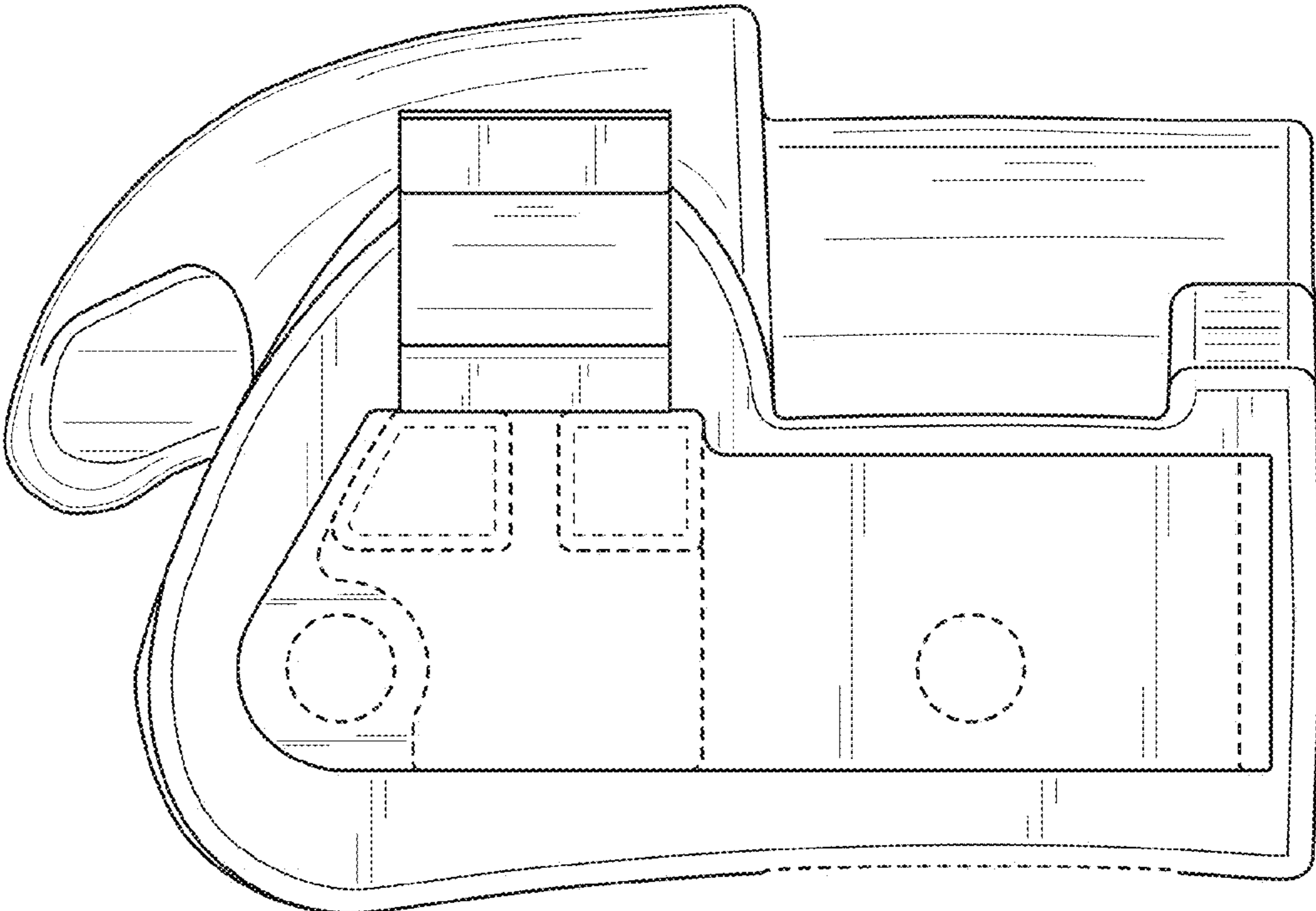

FIG. 7



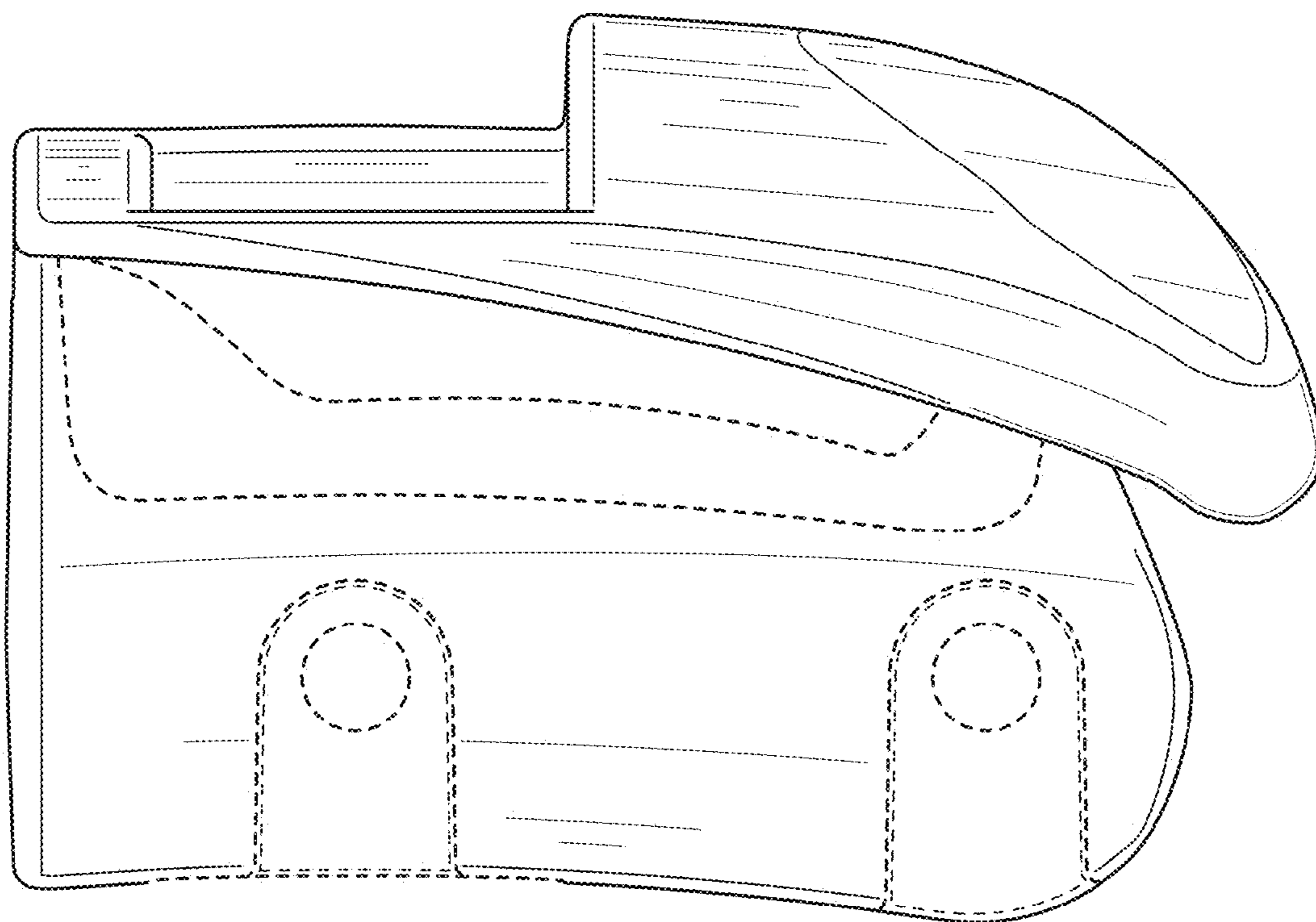

FIG. 8