

US00D747738S

(12) **United States Design Patent**
Park et al.

(10) **Patent No.:** **US D747,738 S**
(45) **Date of Patent:** **** Jan. 19, 2016**

- (54) **DISPLAY SCREEN PORTION WITH ICON**
- (71) Applicant: **SAMSUNG ELECTRONICS CO., LTD.**, Suwon-si, Gyeonggi-do (KR)
- (72) Inventors: **Hye-Bin Park**, Seoul (KR); **You-Jin Im**, Seoul (KR); **Sora Kim**, Seoul (KR); **Joo-Hyung Lee**, Seoul (KR)
- (73) Assignee: **SAMSUNG ELECTRONICS CO., LTD.** (KR)
- (**) Term: **14 Years**
- (21) Appl. No.: **29/465,915**
- (22) Filed: **Sep. 3, 2013**
- (51) **LOC (10) Cl.** **14-04**
- (52) **U.S. Cl.**
USPC **D14/492**
- (58) **Field of Classification Search**
USPC D14/485–495
CPC G06F 3/048; G06F 3/04817
See application file for complete search history.

(56) **References Cited**

U.S. PATENT DOCUMENTS

5,410,326	A *	4/1995	Goldstein	348/734
D362,025	S *	9/1995	Siegfrids	D20/27
D388,071	S *	12/1997	Yamamoto et al.	D14/492
D388,073	S *	12/1997	Yamamoto et al.	D14/492
D388,778	S *	1/1998	Levin et al.	D14/494
D396,458	S *	7/1998	Bohnert et al.	D14/492
D397,332	S *	8/1998	Ryan	D14/487
D405,776	S *	2/1999	Fults	D14/486
6,097,390	A *	8/2000	Marks	715/772
D441,763	S *	5/2001	Kahn et al.	D14/488
D445,428	S *	7/2001	Pattenden	D14/488
D451,536	S *	12/2001	Cornille	D18/27
6,373,505	B1 *	4/2002	Bellamy et al.	715/772
D469,104	S *	1/2003	Istvan et al.	D14/486
D473,237	S *	4/2003	Han et al.	D14/489

D523,872	S *	6/2006	Rozier	D14/489
D532,017	S *	11/2006	Gusmorino et al.	D14/492
D542,301	S *	5/2007	Harvey	D14/489
D544,494	S *	6/2007	Cummins	D14/486
D548,244	S *	8/2007	Fletcher	D14/493
D549,721	S *	8/2007	Ito et al.	D14/488
D553,148	S *	10/2007	Nijima	D14/491
D557,278	S *	12/2007	Harvey et al.	D14/494
D560,225	S *	1/2008	Park et al.	D14/485
D587,277	S *	2/2009	Park et al.	D14/485
D597,101	S *	7/2009	Chaudhri et al.	D14/488
D601,165	S *	9/2009	Truelove et al.	D14/491
D617,334	S *	6/2010	Chaudhri	D14/486
D621,415	S *	8/2010	Umezawa	D14/492
D623,195	S *	9/2010	La et al.	D14/489
D627,791	S *	11/2010	Lamb et al.	D14/489
D628,589	S *	12/2010	Montgomery	D14/492
D637,196	S *	5/2011	Ray et al.	D14/486
D642,588	S *	8/2011	Anzures	D14/486
D644,239	S *	8/2011	Anzures et al.	D14/486
7,996,045	B1 *	8/2011	Bauer et al.	455/566

(Continued)

Primary Examiner — Kevin Rudzinski

(74) *Attorney, Agent, or Firm* — Cantor Colburn LLP

(57) **CLAIM**

We claim, the ornamental design for a display screen portion with icon, as shown and described.

DESCRIPTION

FIG. 1 is a front view of a display screen portion with icon showing our new design;
 FIG. 2 is a second embodiment thereof;
 FIG. 3 is a third embodiment thereof;
 FIG. 4 is a fourth embodiment thereof;
 FIG. 5 is a fifth embodiment thereof;
 FIG. 6 is a sixth embodiment thereof; and,
 FIG. 7 is a seventh embodiment thereof.
 The broken lines illustrating portions of the display screen portion with icon are for environmental purposes only and form no part of the claimed design.

1 Claim, 7 Drawing Sheets

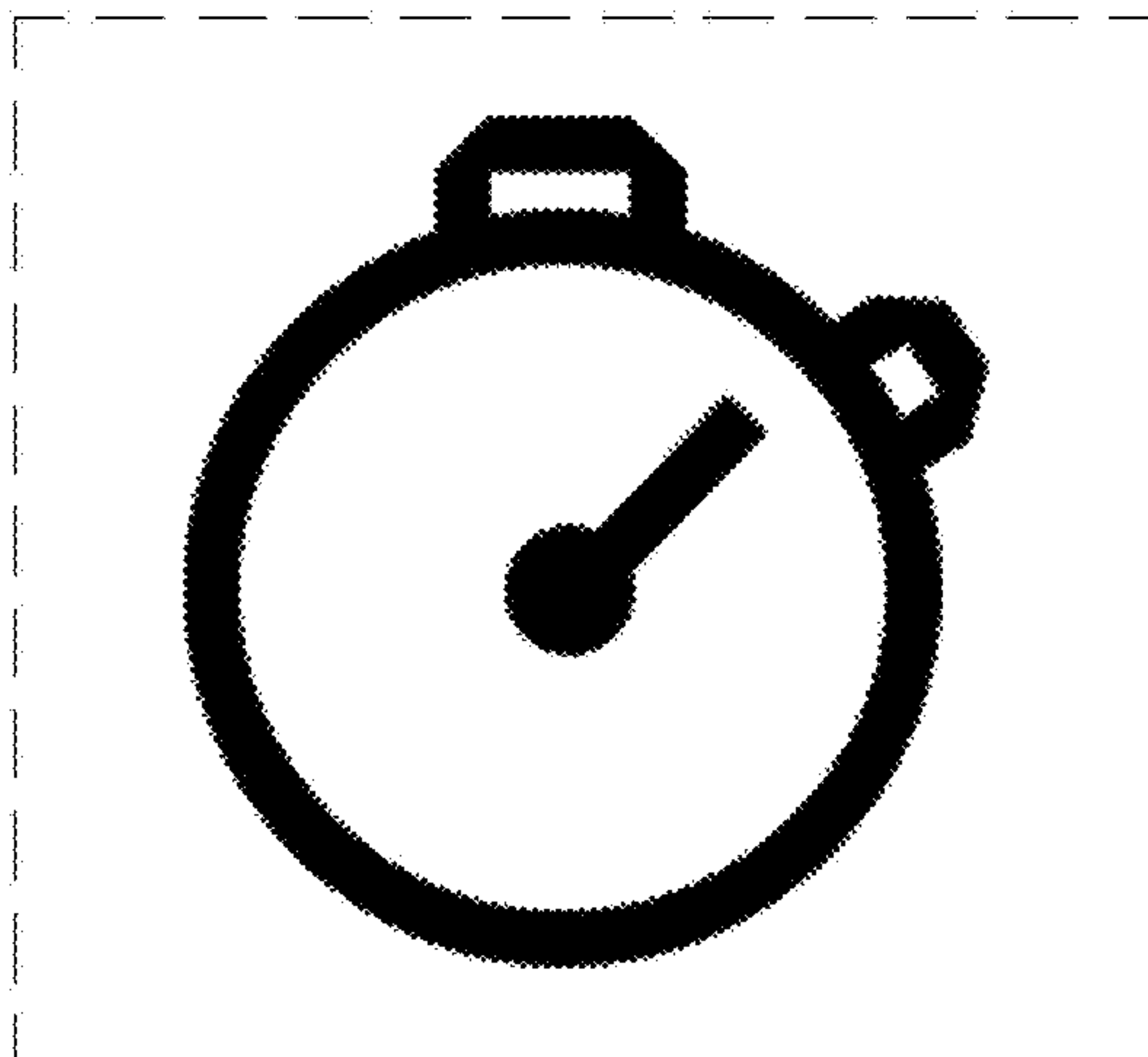

(56)

References Cited

U.S. PATENT DOCUMENTS

D645,470 S *	9/2011	Matas	D14/489	D707,247 S *	6/2014	Jung	D14/487
D659,154 S *	5/2012	Kim et al.	D14/486	D707,248 S *	6/2014	Jung et al.	D14/487
D668,667 S *	10/2012	Song et al.	D14/486	D707,708 S *	6/2014	Harre	D14/492
D681,660 S *	5/2013	Matas	D14/488	D709,908 S *	7/2014	Wujcik et al.	D14/487
D682,850 S *	5/2013	Del Pasqua	D14/485	8,769,427 B2 *	7/2014	Raman et al.	715/773
D687,062 S *	7/2013	Gardner et al.	D14/489	D712,422 S *	9/2014	Anzures	D14/486
D688,270 S *	8/2013	Jang et al.	D14/492	D715,836 S *	10/2014	Huang et al.	D14/492
D690,316 S *	9/2013	Meng et al.	D14/486	D716,837 S *	11/2014	Bickel et al.	D14/487
D690,720 S *	10/2013	Waldman	D14/485	D719,186 S *	12/2014	Kim	D14/488
D695,300 S *	12/2013	Lee et al.	D14/486	D720,360 S *	12/2014	Bae et al.	D14/485
D697,075 S *	1/2014	Waldman	D14/485	D723,053 S *	2/2015	Nagaoka	D14/486
D699,257 S *	2/2014	Yang et al.	D14/486	D726,205 S *	4/2015	Angelides	D14/486
D700,618 S *	3/2014	Hwang et al.	D14/486	D729,839 S *	5/2015	Bray et al.	D14/492
D701,220 S *	3/2014	Kim et al.	D14/485	2005/0188320 A1 *	8/2005	Bocking	715/752
D703,221 S *	4/2014	Park et al.	D14/486	2009/0064038 A1 *	3/2009	Fleischman et al.	715/810
D703,228 S *	4/2014	Abratowski et al.	D14/489	2009/0304359 A1 *	12/2009	Lemay et al.	386/96
D706,283 S *	6/2014	Pedraza Padilla et al. ...	D14/486	2010/0037139 A1 *	2/2010	Loebig et al.	715/716
D706,827 S *	6/2014	Harre	D14/492	2010/0162165 A1 *	6/2010	Addala et al.	715/810
				2012/0179988 A1 *	7/2012	Suh et al.	715/767
				2013/0326421 A1 *	12/2013	Jo	715/841

* cited by examiner

FIG. 1

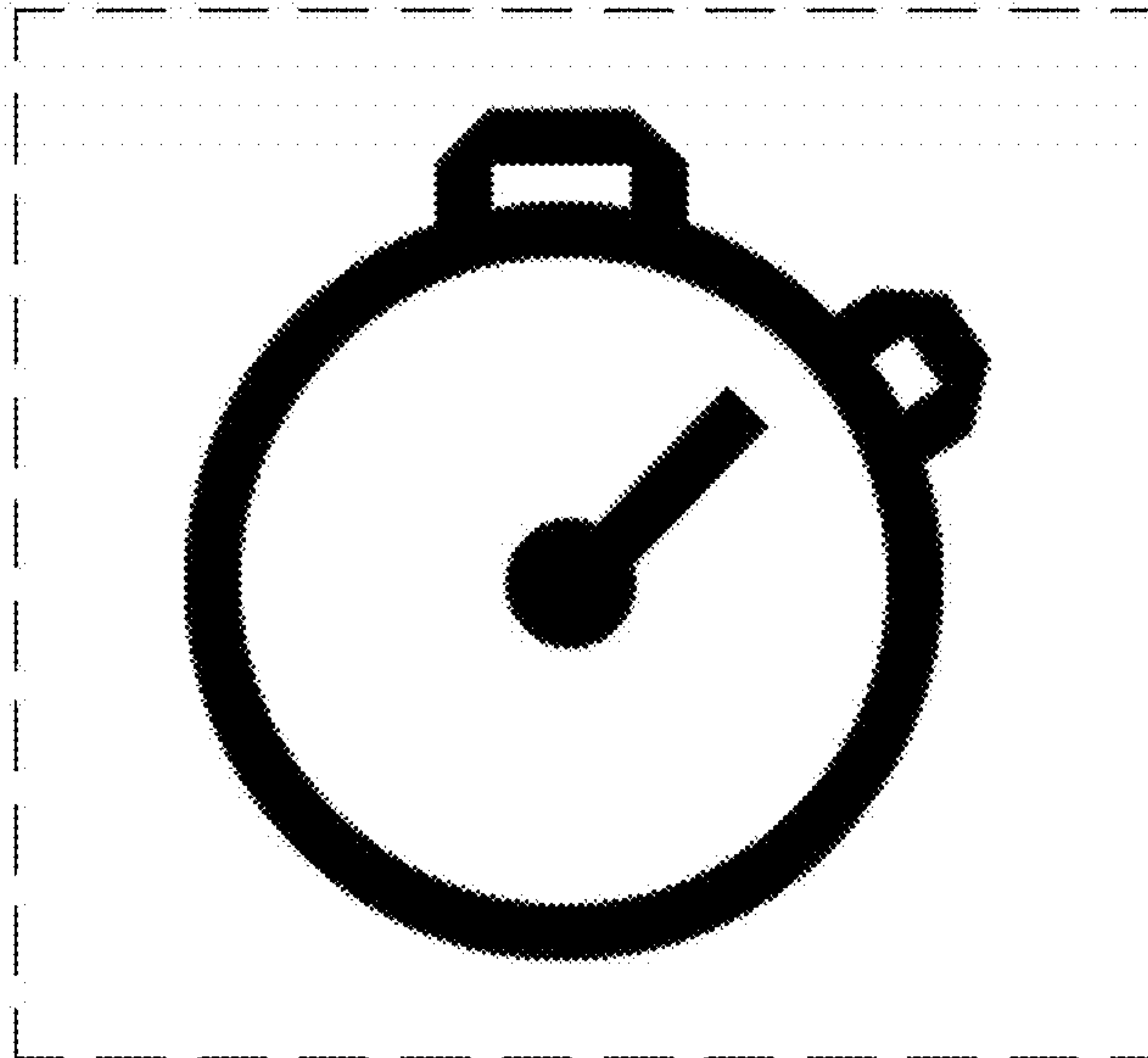

FIG. 2

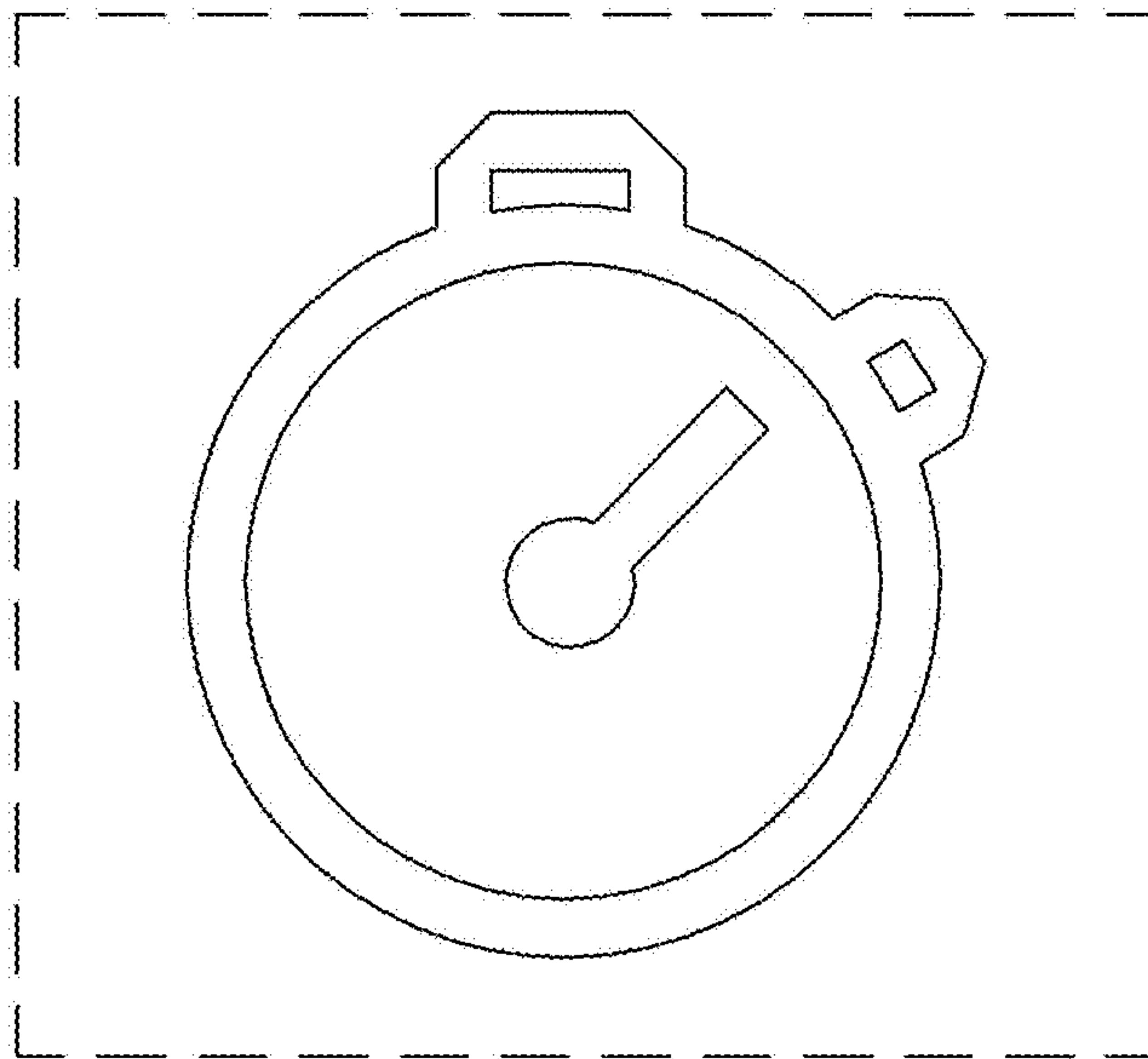

FIG. 3

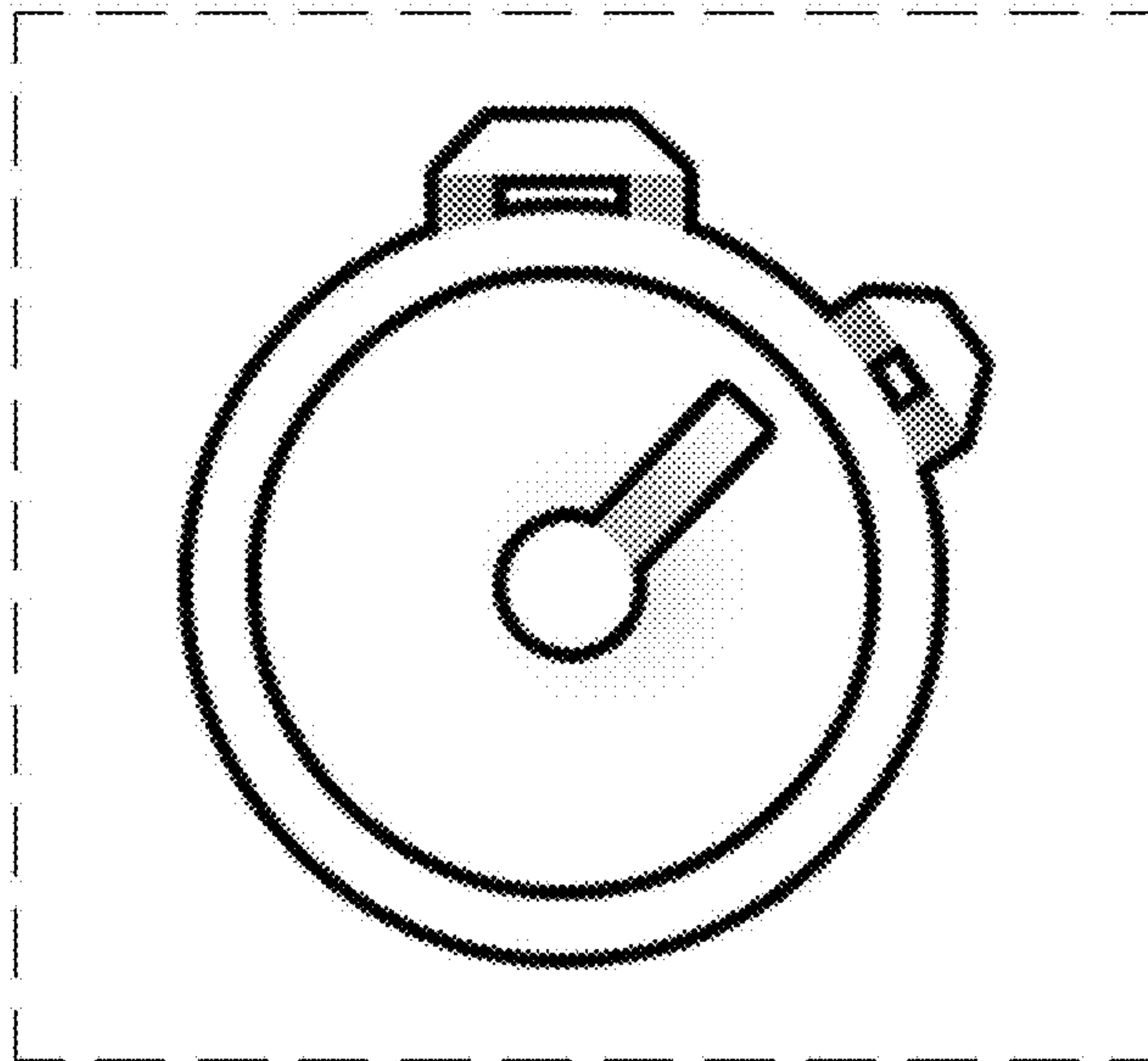

FIG. 4

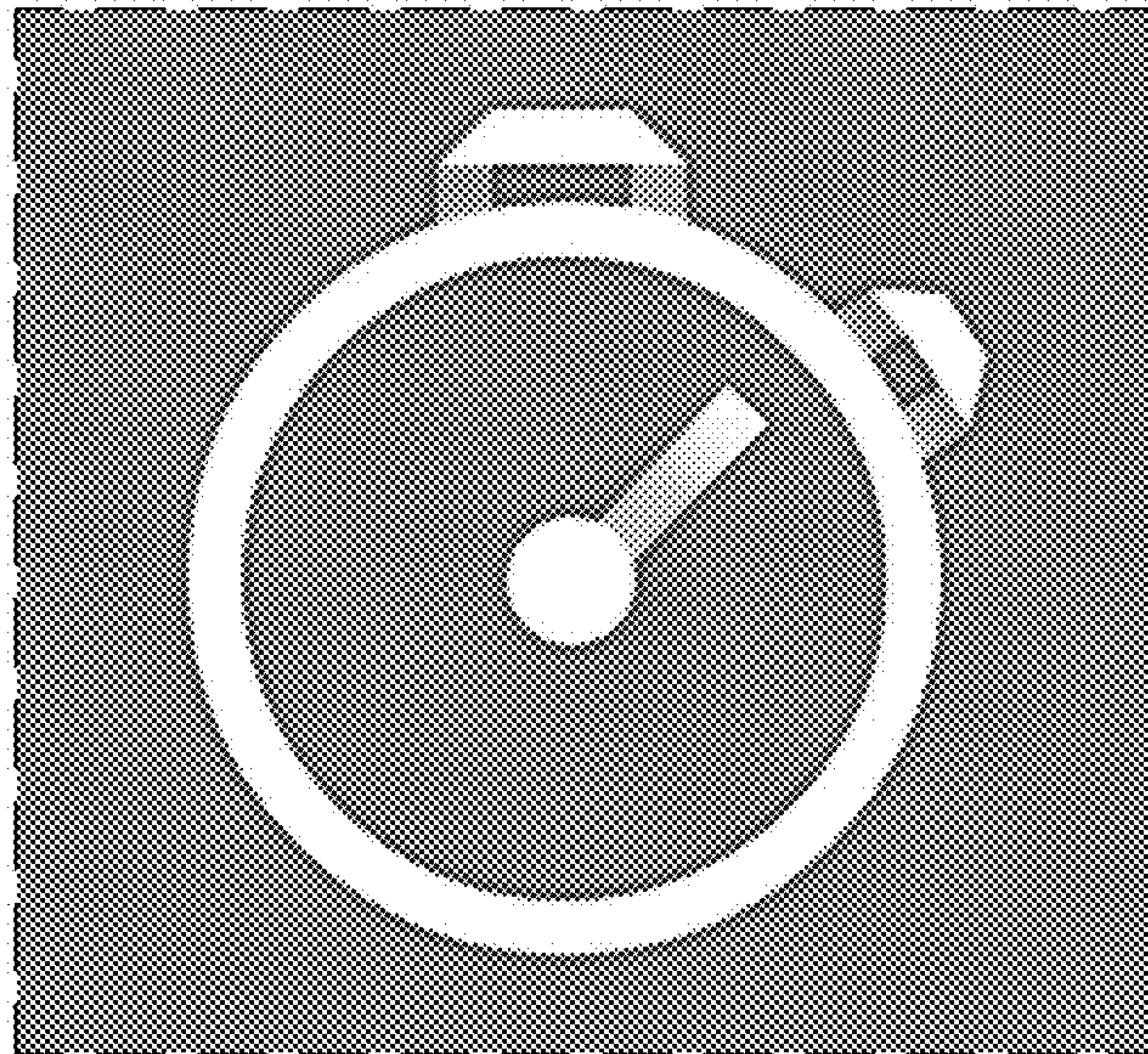

FIG. 5

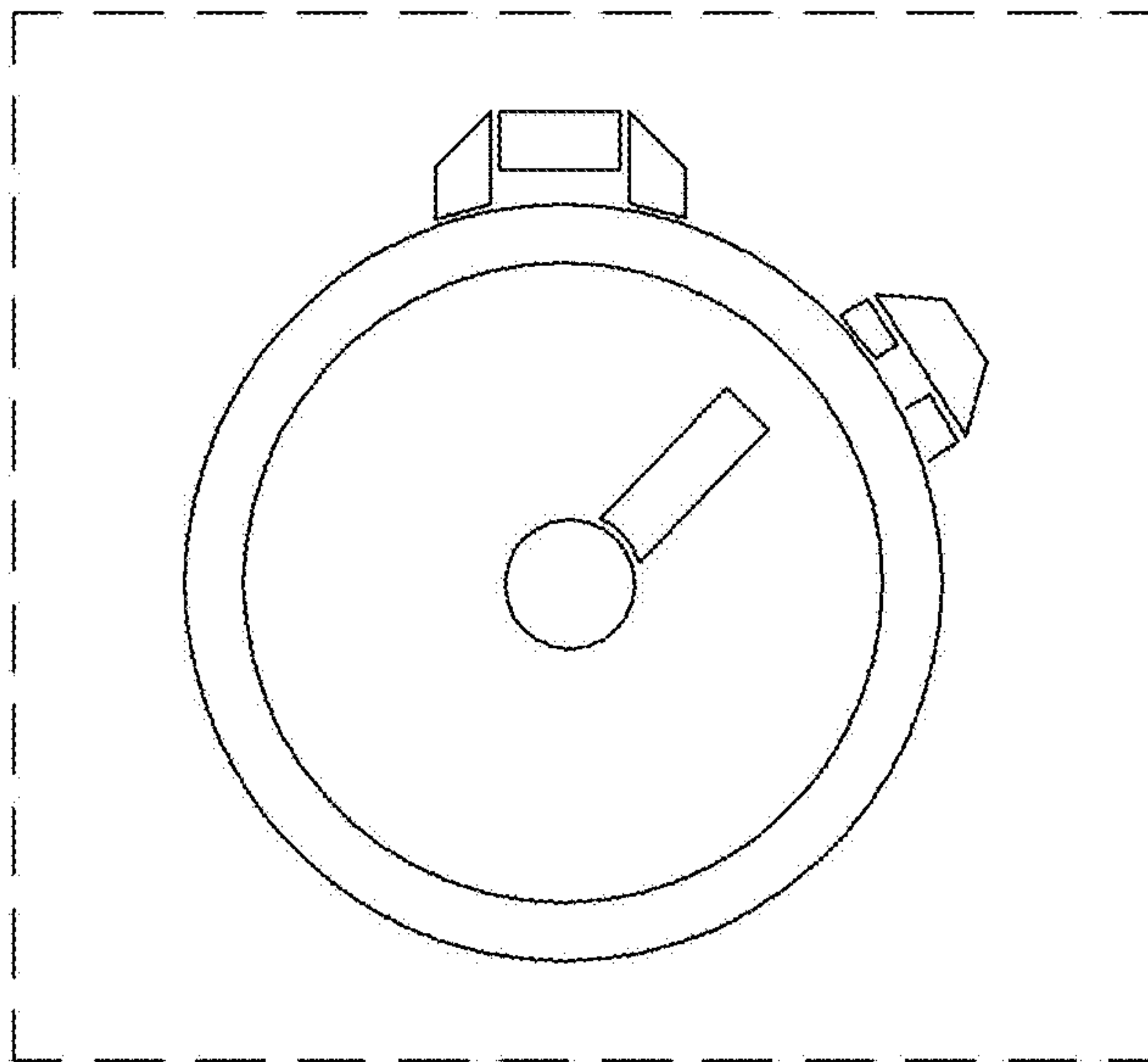

FIG. 6

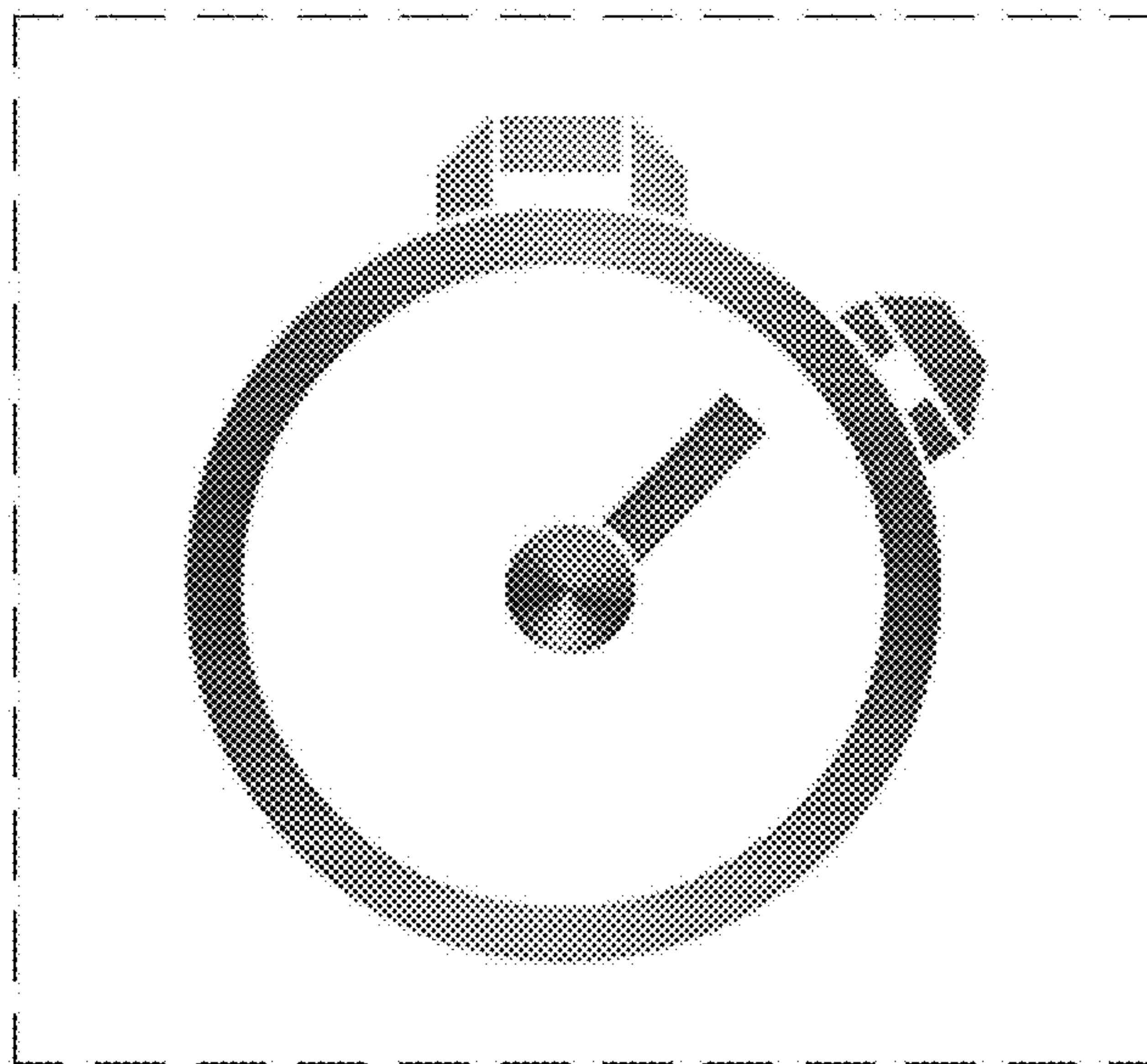

FIG. 7

