



US00D747713S

(12) **United States Design Patent**  
**Choi et al.**

(10) **Patent No.:** **US D747,713 S**  
(45) **Date of Patent:** **\*\* Jan. 19, 2016**

(54) **TABLET PC**

(71) Applicant: **Samsung Electronics Co., Ltd.**,  
Suwon-si (KR)

(72) Inventors: **Jung-Hyun Choi**, Seoul (KR);  
**Tae-Joong Kim**, Goyang-si (KR);  
**Christine Oh**, Yongin-si (KR)

(73) Assignee: **Samsung Electronics Co., Ltd.**,  
Suwon-si (KR)

(\*\*) Term: **14 Years**

(21) Appl. No.: **29/494,412**

(22) Filed: **Jun. 20, 2014**

(30) **Foreign Application Priority Data**

Jan. 3, 2014 (KR) ..... 30-2014-0000455

(51) **LOC (10) Cl.** ..... **14-02**

(52) **U.S. Cl.**  
USPC ..... **D14/341**

(58) **Field of Classification Search**  
USPC ..... D14/241, 138 R, 138 AA, 138 G, 203.2,  
D14/248, 496; 361/679.3; 455/575.4;  
345/153  
CPC ..... G06F 1/16  
See application file for complete search history.

(56) **References Cited**

**U.S. PATENT DOCUMENTS**

D490,420 S \* 5/2004 Solomon ..... D14/341  
D502,173 S \* 2/2005 Jung ..... D13/158  
D504,889 S \* 5/2005 Andre ..... D14/341  
D584,738 S \* 1/2009 Kim ..... D14/496  
D593,087 S \* 5/2009 Andre ..... D14/138 G  
D598,016 S \* 8/2009 Han ..... D14/341  
D600,241 S \* 9/2009 Andre ..... D14/203.7  
D600,690 S \* 9/2009 Miyaji ..... D14/341

D602,488 S \* 10/2009 Jiang ..... D14/341  
D615,059 S \* 5/2010 Price ..... D14/138 G  
D615,083 S \* 5/2010 Andre ..... D14/341  
D623,184 S \* 9/2010 Green ..... D14/346  
D624,896 S \* 10/2010 Park ..... D14/138 G  
D625,307 S \* 10/2010 Cheng ..... D14/341  
D626,937 S \* 11/2010 Yeo ..... D14/203.3  
D627,777 S \* 11/2010 Akana ..... D14/341  
D636,769 S \* 4/2011 Wood ..... D14/341  
D636,770 S \* 4/2011 Li ..... D14/341  
D637,596 S \* 5/2011 Akana ..... D14/341  
D638,814 S \* 5/2011 Sutherland ..... D14/138 G  
D638,815 S \* 5/2011 Lee ..... D14/138 G  
D639,261 S \* 6/2011 Garnham ..... D14/138 G

(Continued)

*Primary Examiner* — Paula Greene

(74) *Attorney, Agent, or Firm* — NSIP Law

(57) **CLAIM**

We claim the ornamental design for a tablet PC, as shown and described.

**DESCRIPTION**

FIG. 1 is a front perspective view of a tablet PC showing our new design;

FIG. 2 is a front view thereof;

FIG. 3 is a rear view thereof;

FIG. 4 is a left-side view thereof;

FIG. 5 is a right-side view thereof;

FIG. 6 is a top view thereof;

FIG. 7 is a bottom view thereof;

FIG. 8 is an enlarged view of the encircled portion in FIG. 1;

FIG. 9 is an enlarged view of the encircled portion in FIG. 2;

and,

FIG. 10 is an enlarged view of the encircled portion in FIG. 6.

The broken lines in the figures show portions of the tablet PC which form no part of the claimed design.

The dot-dash broken lines encircling portions of the claimed design that are illustrated in enlargements form no part of the claimed design.

**1 Claim, 10 Drawing Sheets**

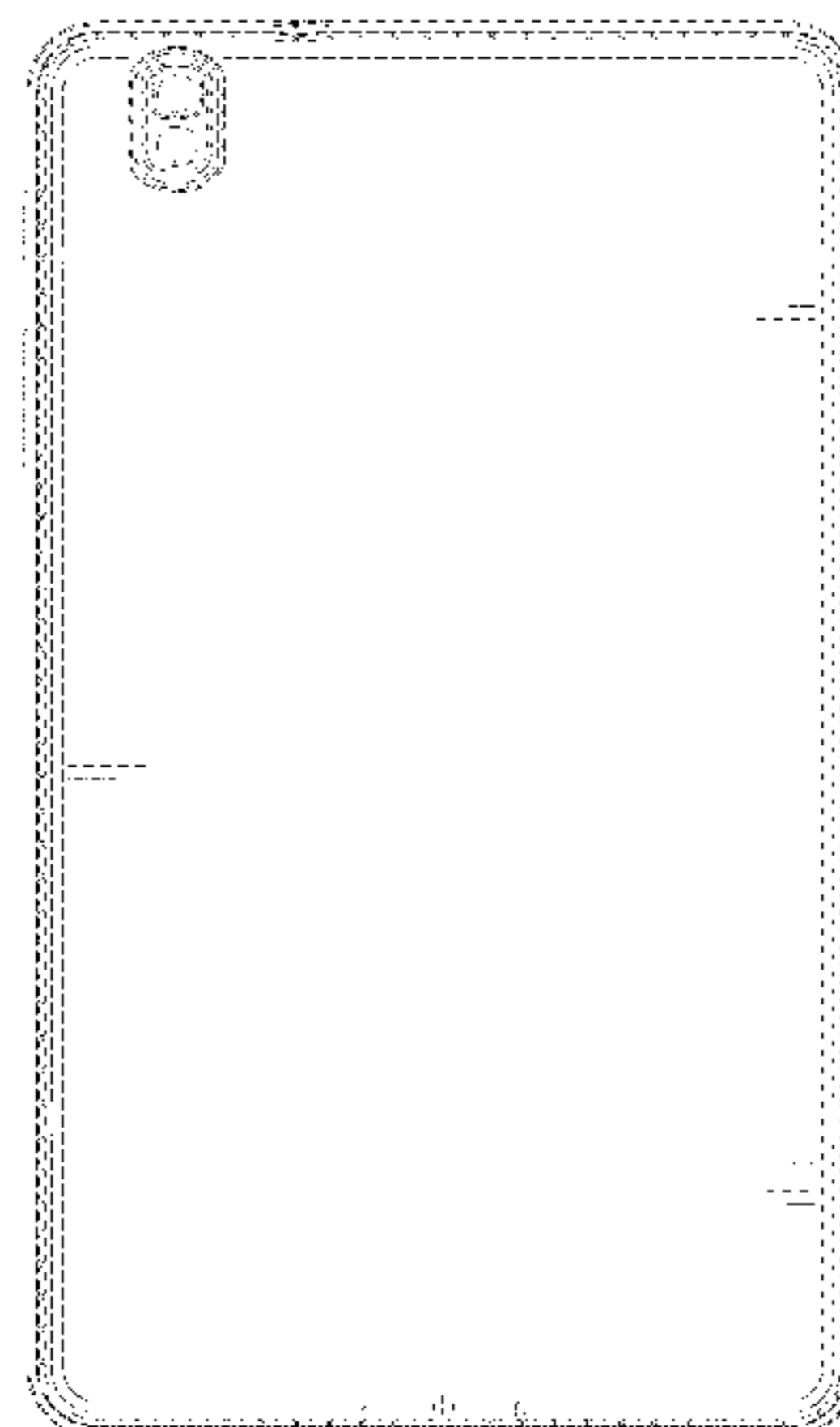
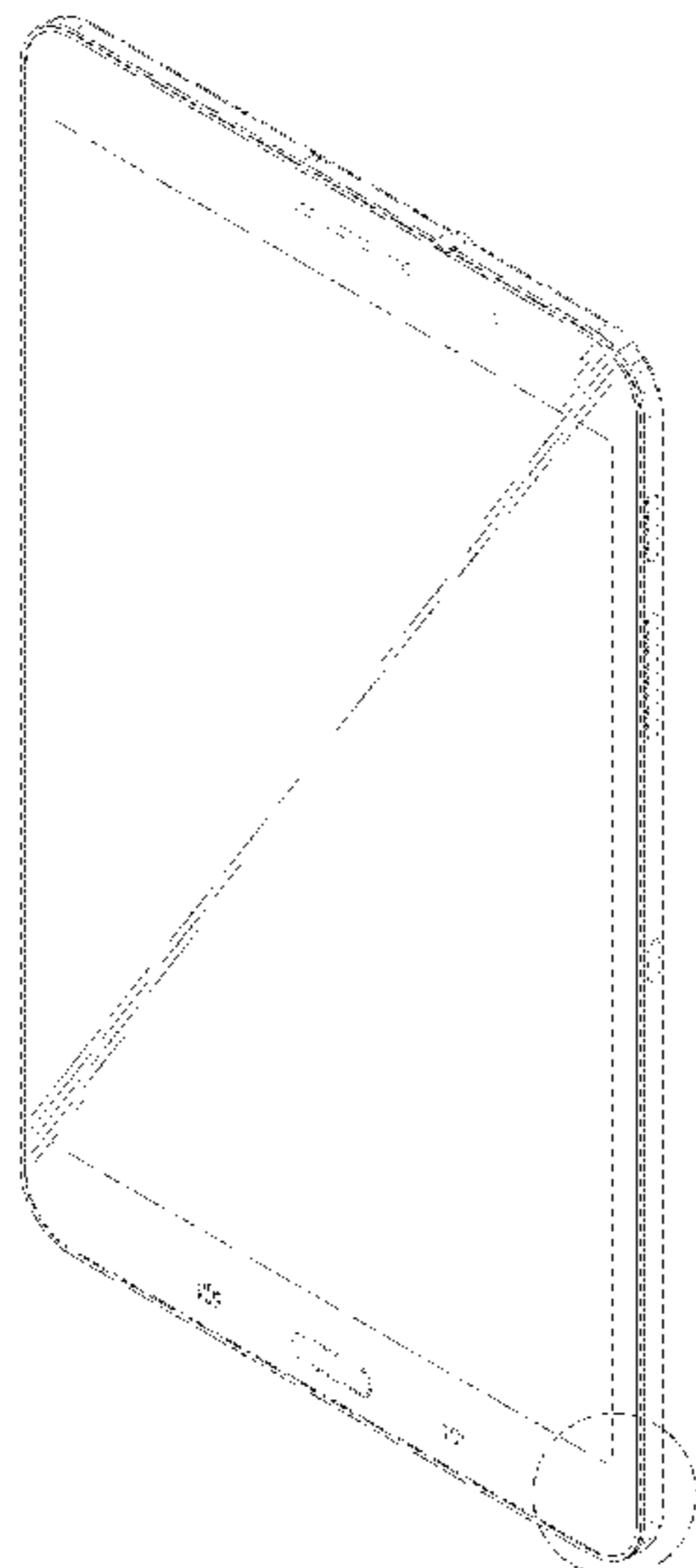

(56)

References Cited

U.S. PATENT DOCUMENTS

D639,805 S *	6/2011	Song	D14/138 G	D702,208 S *	4/2014	Shin	D14/138 G
D640,220 S *	6/2011	Shyu	D14/138 AD	D704,701 S *	5/2014	Andre	D14/341
7,969,732 B1 *	6/2011	Noble	F16M 11/041 248/917	D711,338 S *	8/2014	Park	D14/138 G
D645,833 S *	9/2011	Seflic	D14/138 G	D714,752 S *	10/2014	Im	D14/138 G
D648,303 S *	11/2011	Park	D14/138 G	D717,266 S *	11/2014	Chung	D14/138 G
8,094,441 B2 *	1/2012	Tseng	B29C 43/12 200/296	D718,267 S *	11/2014	Hu	D14/138 G
D657,329 S *	4/2012	Son	D14/138 G	D721,342 S *	1/2015	Kim	D14/138 G
D666,198 S *	8/2012	Van Den Nieuwenhuizen	D14/341	D721,667 S *	1/2015	Chuang	D14/138 G
D667,006 S *	9/2012	Van Den Nieuwenhuizen	D14/341	D722,034 S *	2/2015	Lee	D14/138 G
D668,628 S *	10/2012	Ha	D14/138 G	D722,581 S *	2/2015	Kim	D14/138 G
D668,650 S *	10/2012	Han	D14/138 G	D723,547 S *	3/2015	Zhou	D14/341
D669,468 S *	10/2012	Akana	D14/341	D735,689 S *	8/2015	Jung	D14/138 G
D670,286 S *	11/2012	Akana	D14/341	D737,814 S *	9/2015	Cha	D14/341
D672,344 S *	12/2012	Li	D14/341	D738,370 S *	9/2015	Cha	D14/341
D673,561 S *	1/2013	Hyun	D14/341	D738,371 S *	9/2015	Akana	D14/341
D676,459 S *	2/2013	Hofer	D14/203.3	2004/0041504 A1 *	3/2004	Ozolins	G02F 1/1333 313/110
D676,822 S *	2/2013	Seo	D14/138 G	2010/0061055 A1 *	3/2010	Dabov	G06F 1/1626 361/679.56
D689,840 S *	9/2013	Lu	D14/138 G	2013/0331150 A1 *	12/2013	Butsusaka	H04M 1/3888 455/566
D701,850 S *	4/2014	Kim	D14/138 G	2014/0192467 A1 *	7/2014	Kwong	G06F 1/1601 361/679.3
				2015/0065210 A1 *	3/2015	Drori	A63F 13/02 455/575.8

\* cited by examiner

FIG. 1

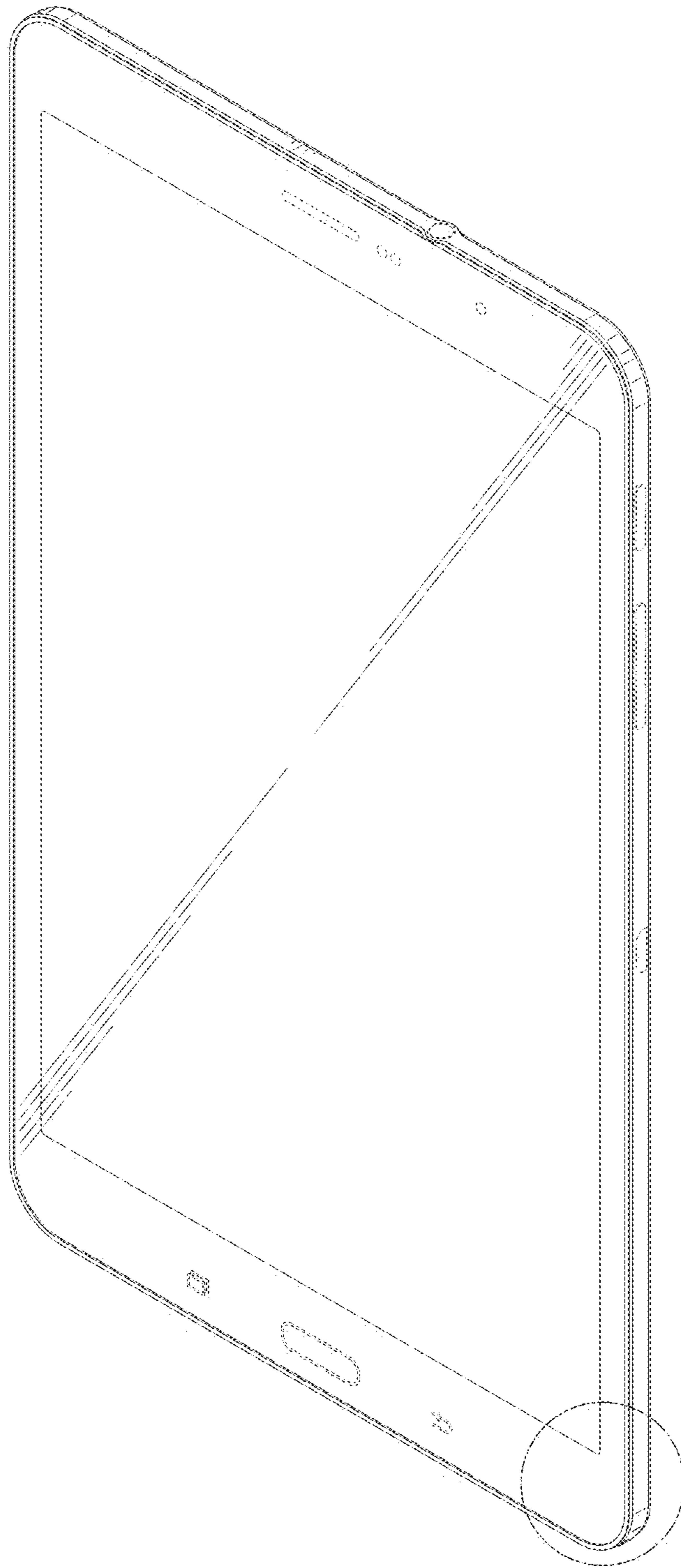

FIG. 2

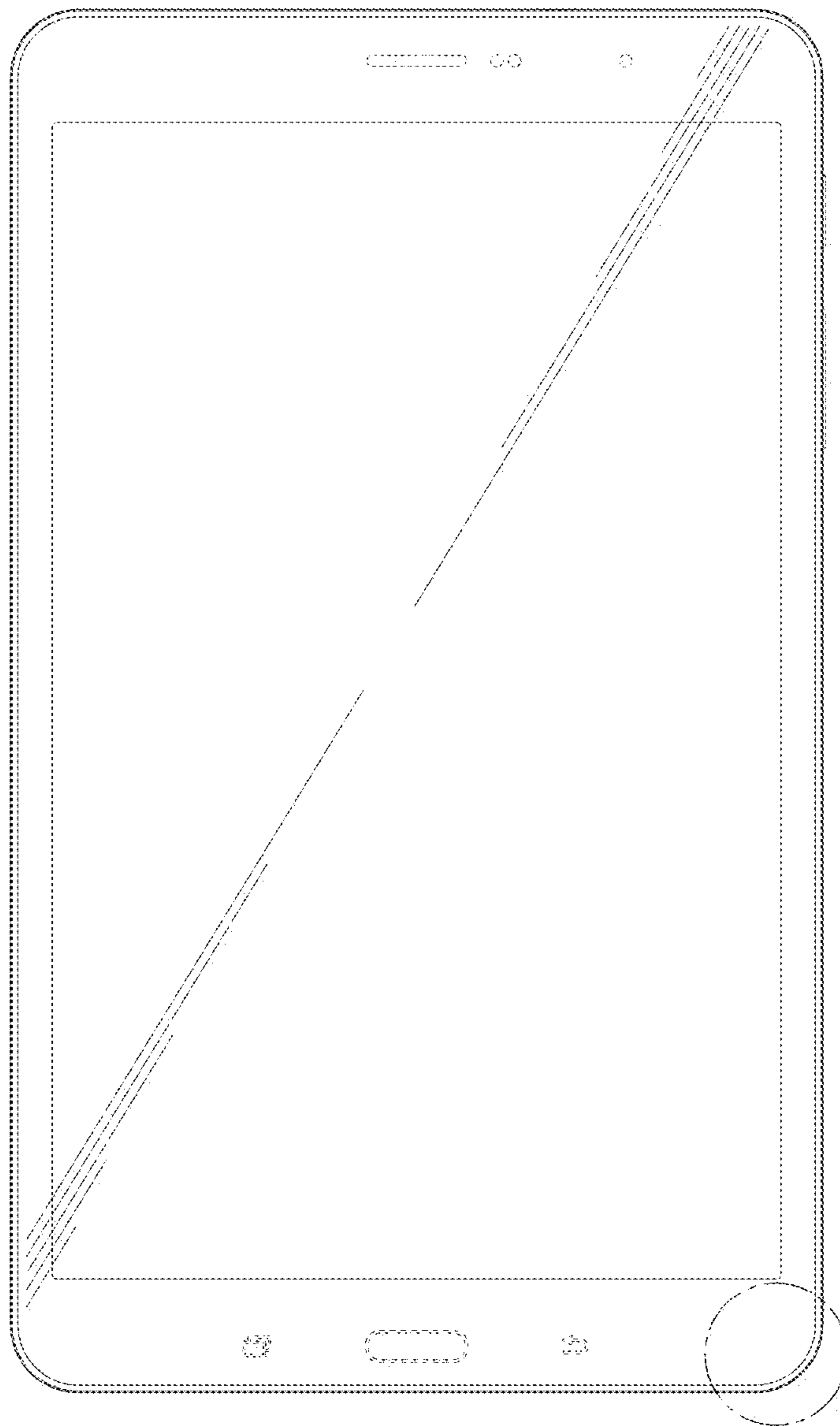

FIG. 3

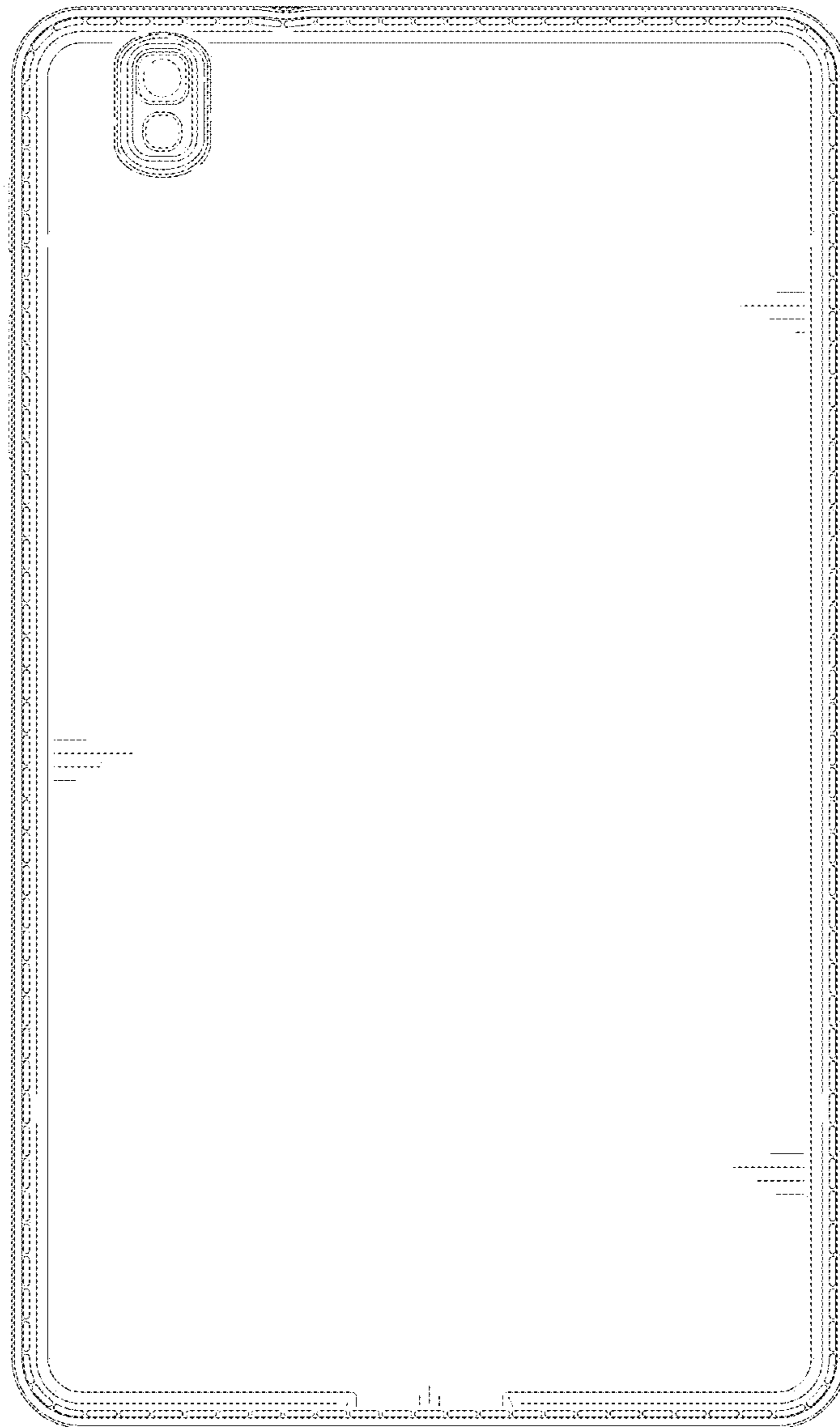

FIG. 4

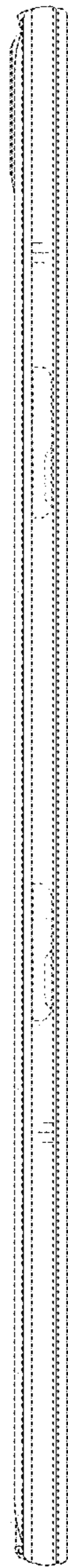

FIG. 5

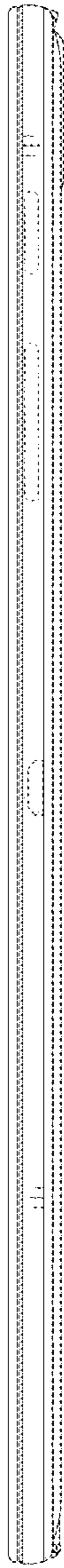

FIG. 6

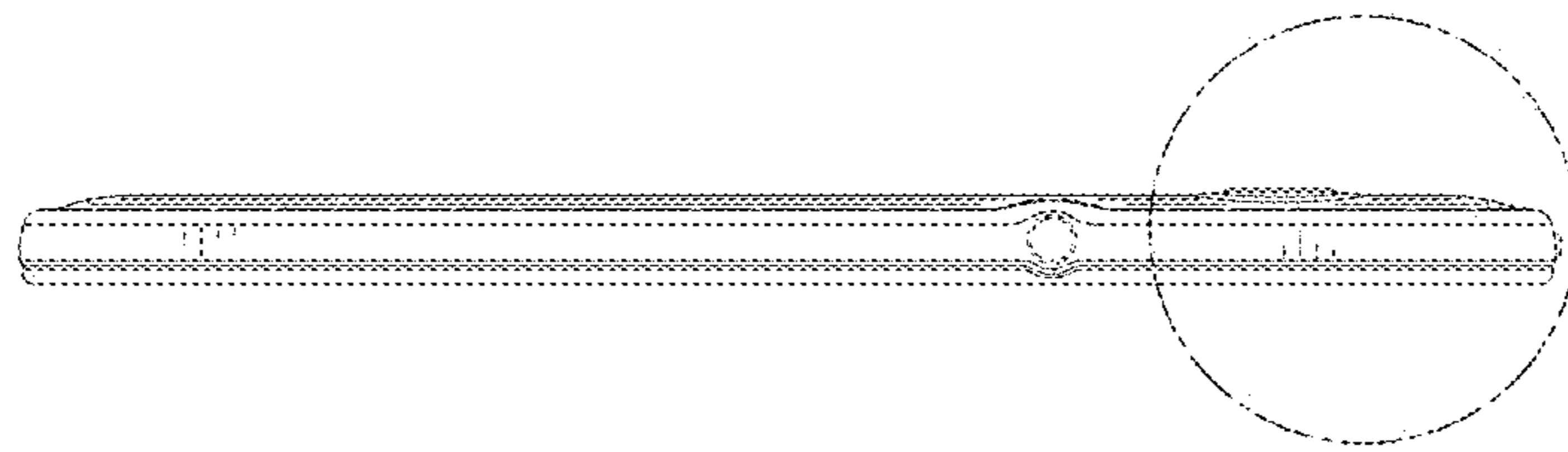



FIG. 7

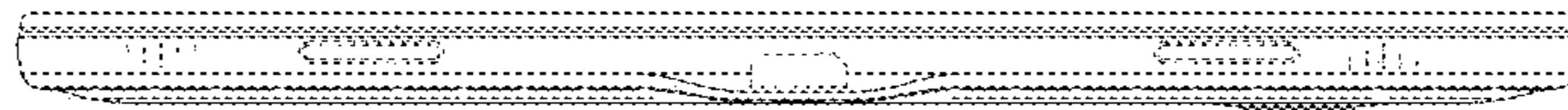

FIG. 8

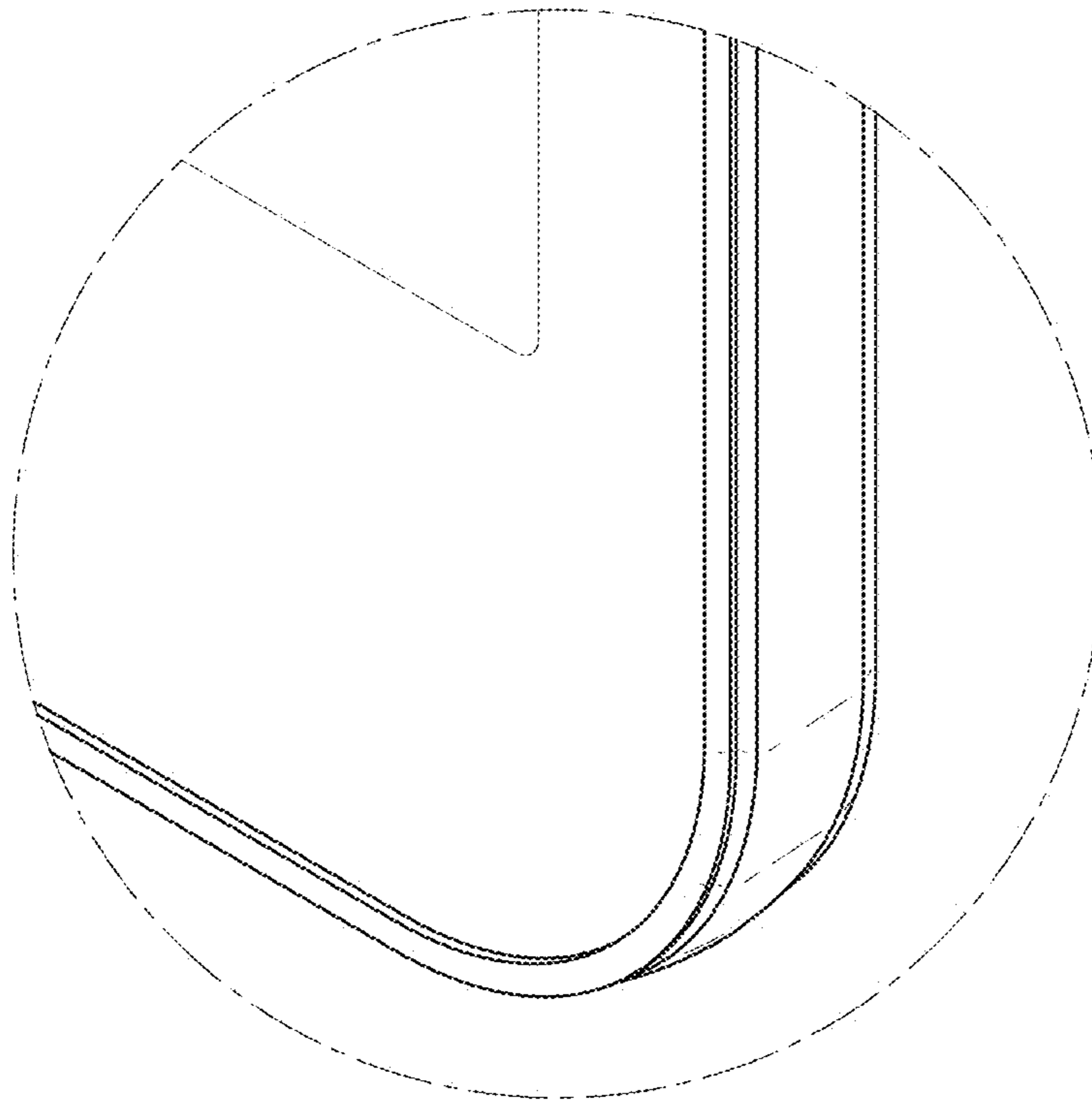

FIG. 9

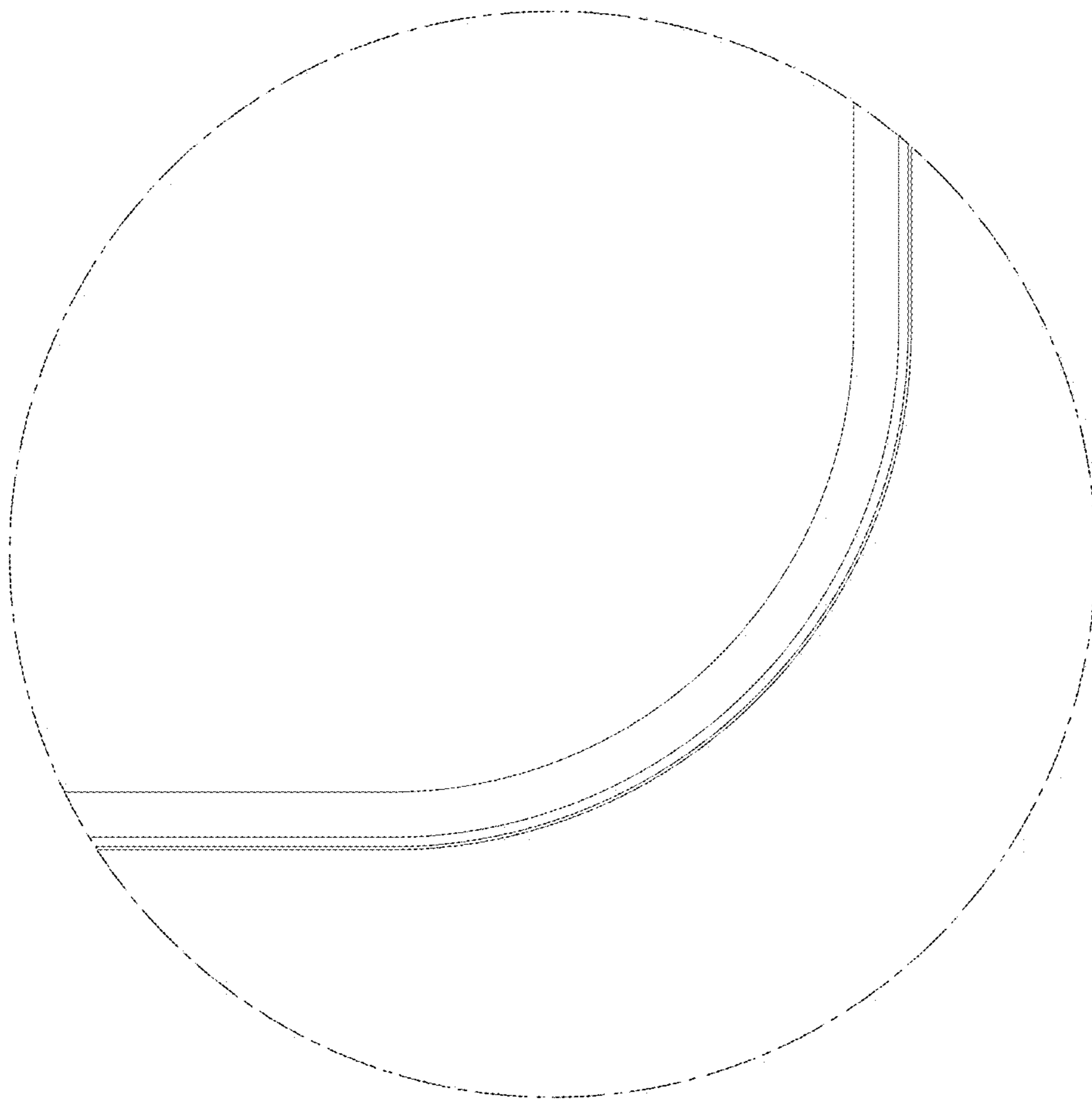

FIG. 10

