



US00D747702S

(12) **United States Design Patent**
Breines

(10) **Patent No.:** **US D747,702 S**
(45) **Date of Patent:** **** Jan. 19, 2016**

- (54) **HEADPHONE**
- (71) Applicant: **Robert Breines**, Westlake Village, CA (US)
- (72) Inventor: **Robert Breines**, Westlake Village, CA (US)
- (**) Term: **14 Years**
- (21) Appl. No.: **29/515,059**
- (22) Filed: **Jan. 20, 2015**
- (51) **LOC (10) Cl.** **14-01**
- (52) **U.S. Cl.**
USPC **D14/223**
- (58) **Field of Classification Search**
USPC D14/205, 206, 223; 181/129, 130.135; 379/430, 431; 381/380, 381; 455/90.3, 455/575.2
CPC H04R 1/10
See application file for complete search history.

- D555,152 S * 11/2007 Wang D14/223
- D557,689 S * 12/2007 Huang D14/223
- D566,687 S * 4/2008 Duarte D14/205
- D572,703 S * 7/2008 Ledbetter D14/205
- D586,332 S * 2/2009 Ewert D14/223
- D591,721 S * 5/2009 Densho D14/205
- D603,377 S * 11/2009 Chung D14/223
- 8,077,898 B2 * 12/2011 Huang H04R 1/1016
381/186
- D652,024 S * 1/2012 Quek D14/223
- D657,780 S * 4/2012 Dahlberg D14/223
- D666,996 S * 9/2012 Hardi D14/223
- 8,265,323 B2 * 9/2012 Stiehl B29C 45/0025
381/371
- D676,427 S * 2/2013 Yang D14/223
- D682,257 S * 5/2013 Zheng D14/223
- D685,350 S * 7/2013 Mogili D14/223
- D687,418 S * 8/2013 Godfrey D14/223
- D695,721 S * 12/2013 Thompson D14/223
- D718,284 S * 11/2014 Shibusawa D14/223
- D741,287 S * 10/2015 Harata D14/205
- 2012/0237074 A1 * 9/2012 Aase H04R 1/1016
381/380
- 2013/0343595 A1 * 12/2013 Zorkendorfer H04R 1/10
381/380

* cited by examiner

Primary Examiner — Paula Greene

(56) **References Cited**

U.S. PATENT DOCUMENTS

- 1,406,510 A * 2/1922 Weber H04R 1/1016
381/328
- D331,061 S * 11/1992 Hyohgo D14/223
- D331,062 S * 11/1992 Kanno D14/223
- D337,119 S * 7/1993 Taniguchi D14/223
- D337,589 S * 7/1993 Wada D14/223
- D340,932 S * 11/1993 Yan D14/249
- D369,349 S * 4/1996 Hayashi D14/223
- 5,949,896 A * 9/1999 Nageno H04R 1/1016
381/328
- 6,668,064 B1 * 12/2003 Lin H04R 1/1016
381/328
- D499,397 S * 12/2004 Hlas D14/223
- D502,171 S * 2/2005 Tang D14/205
- 6,868,284 B2 * 3/2005 Bae H04M 1/05
379/428.02
- D510,337 S * 10/2005 Tages D14/205
- D517,054 S * 3/2006 Yang D14/205
- D533,868 S * 12/2006 Koizumi D14/223
- D554,109 S * 10/2007 Ledbetter D14/223

(57) **CLAIM**

I claim the ornamental design for a headphone, as shown and described.

DESCRIPTION

FIG. 1 is a front perspective view of a headphone, showing the new design;
 FIG. 2 is a front elevational view thereof;
 FIG. 3 is a rear elevational view thereof;
 FIG. 4 is a right-side elevational view thereof;
 FIG. 5 is a left-side elevational view thereof;
 FIG. 6 is a top plan view thereof; and,
 FIG. 7 is a bottom plan view thereof.
 The broken lines showing a cable in FIGS. 1-5 and 7 form no part of the claimed design.

1 Claim, 2 Drawing Sheets

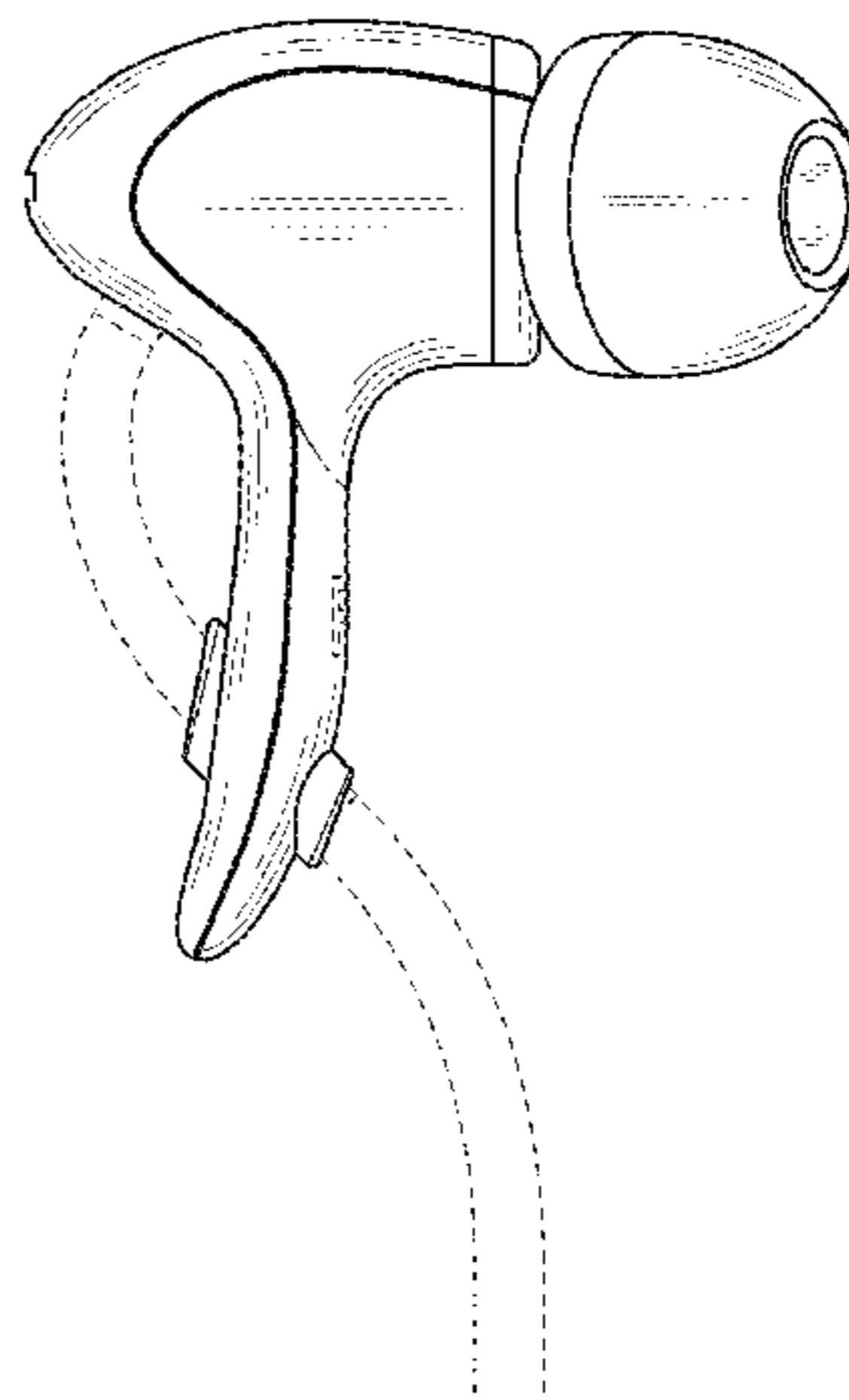
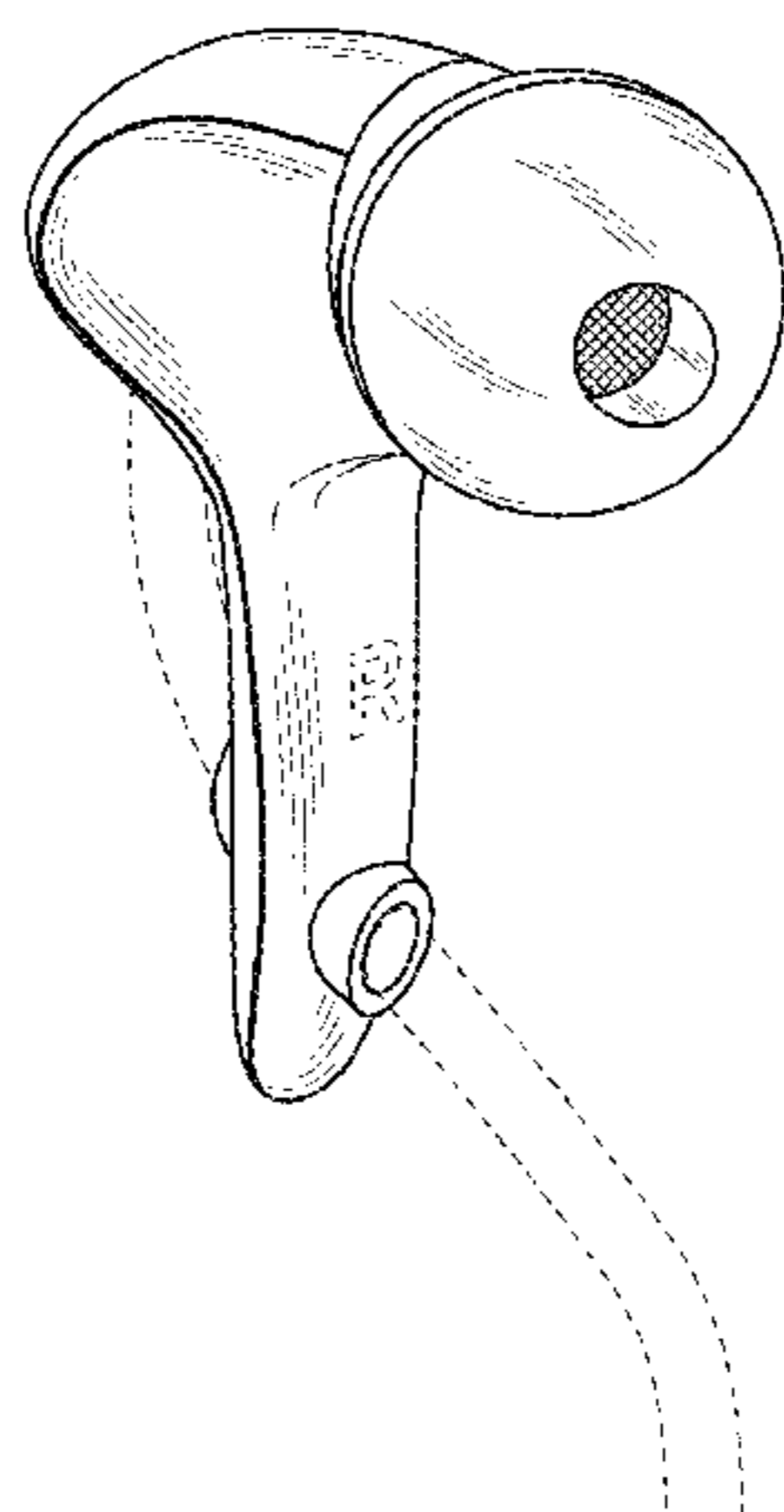

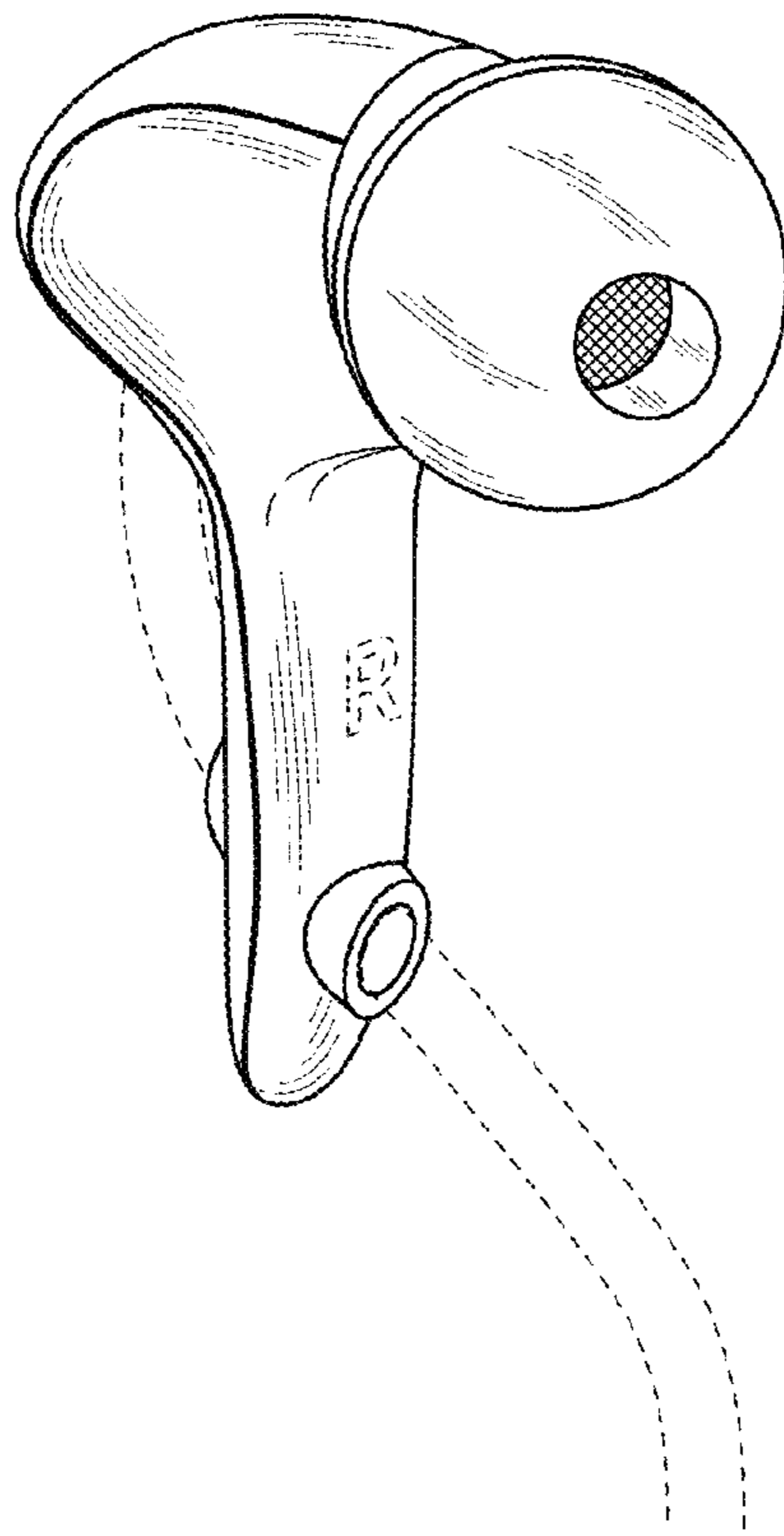

FIG. 1

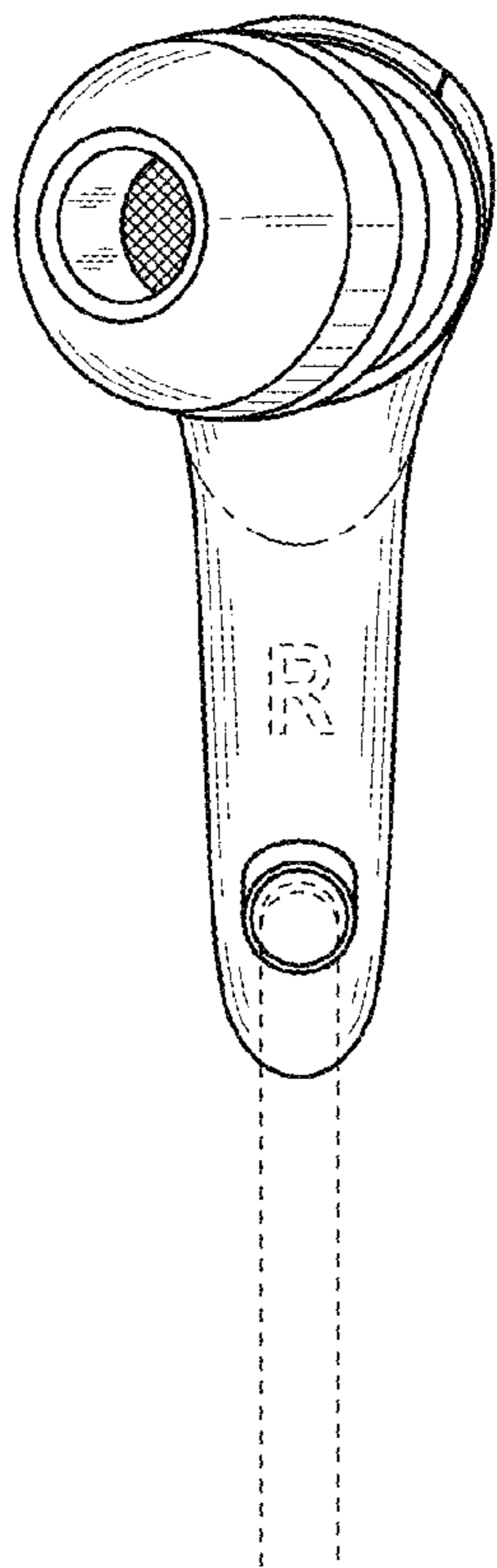

FIG. 2

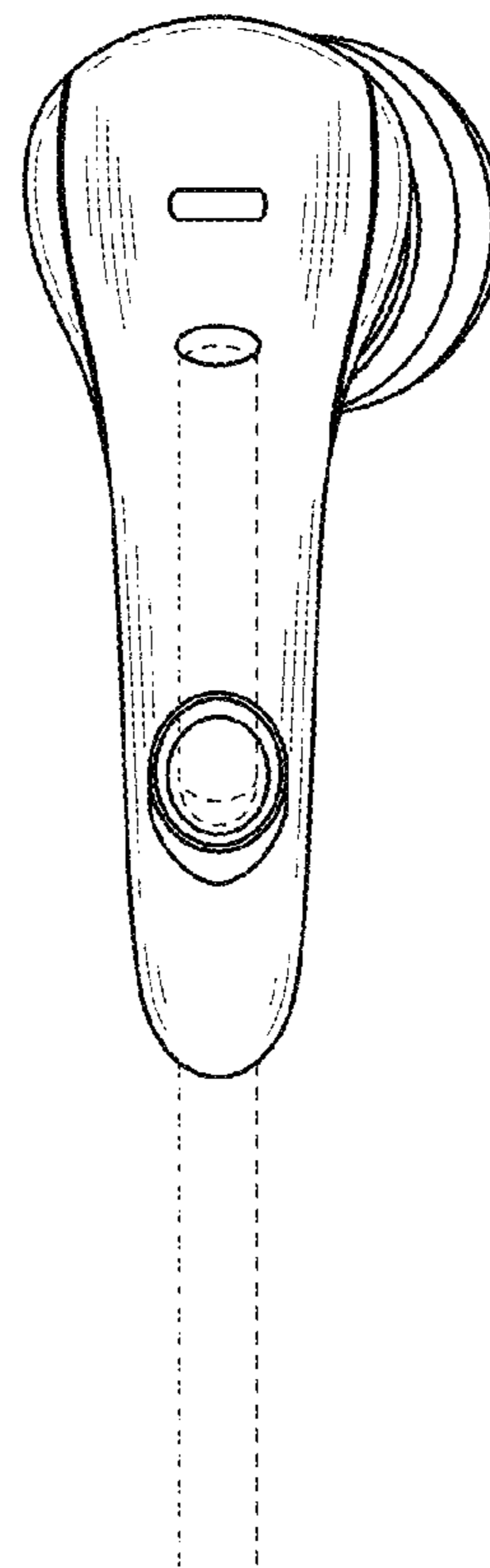

FIG. 3

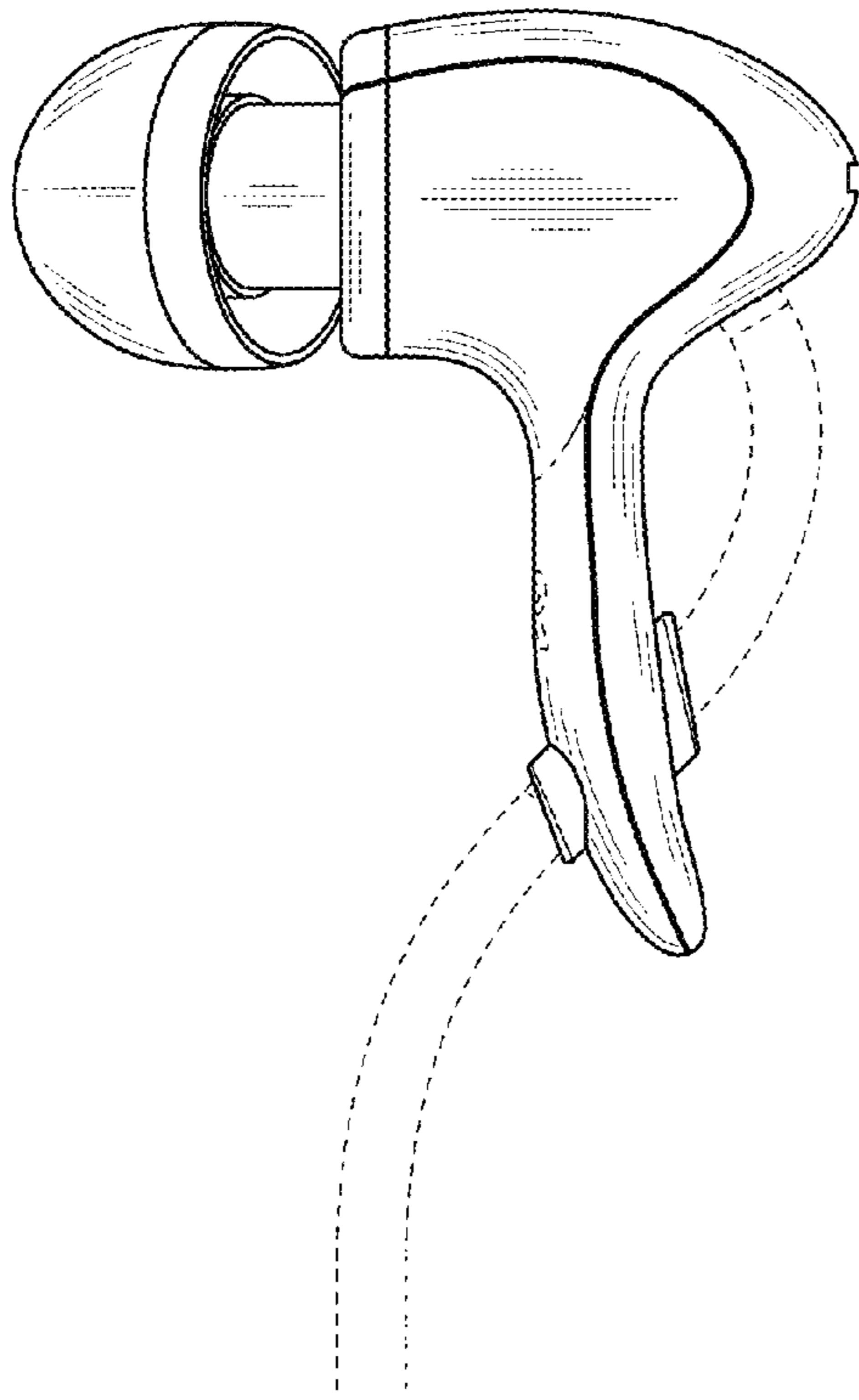

FIG. 4

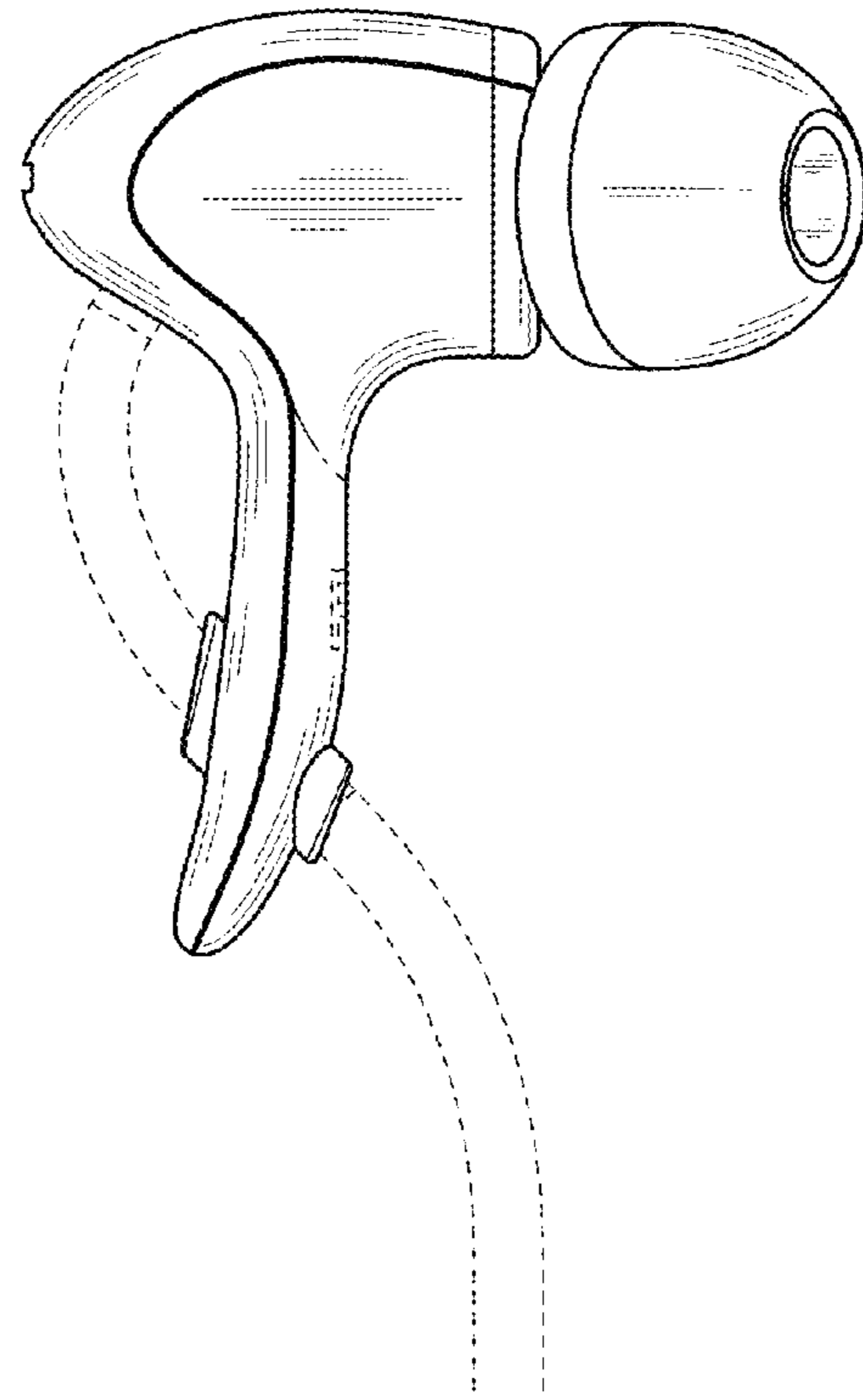

FIG. 5

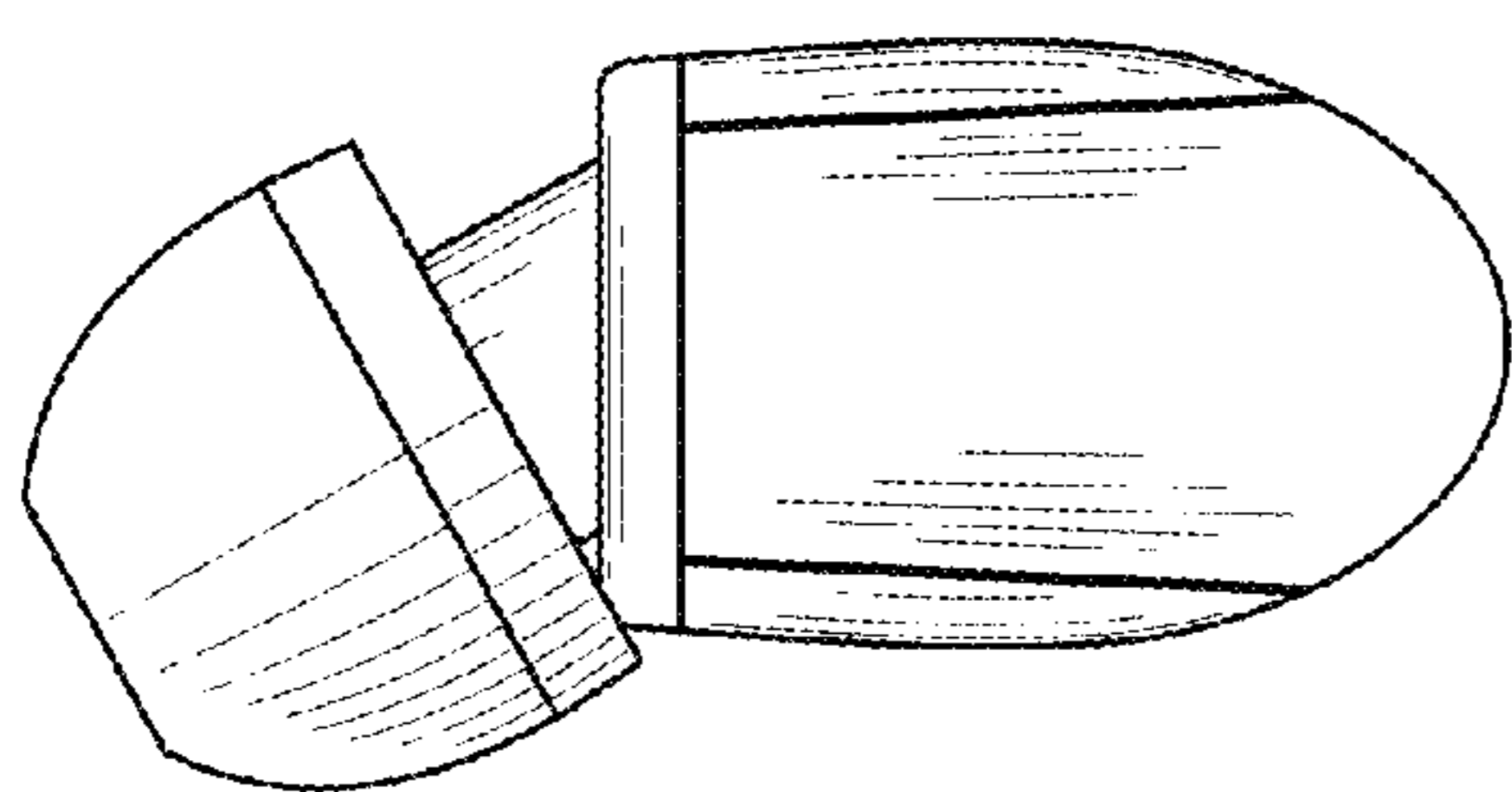

FIG. 6

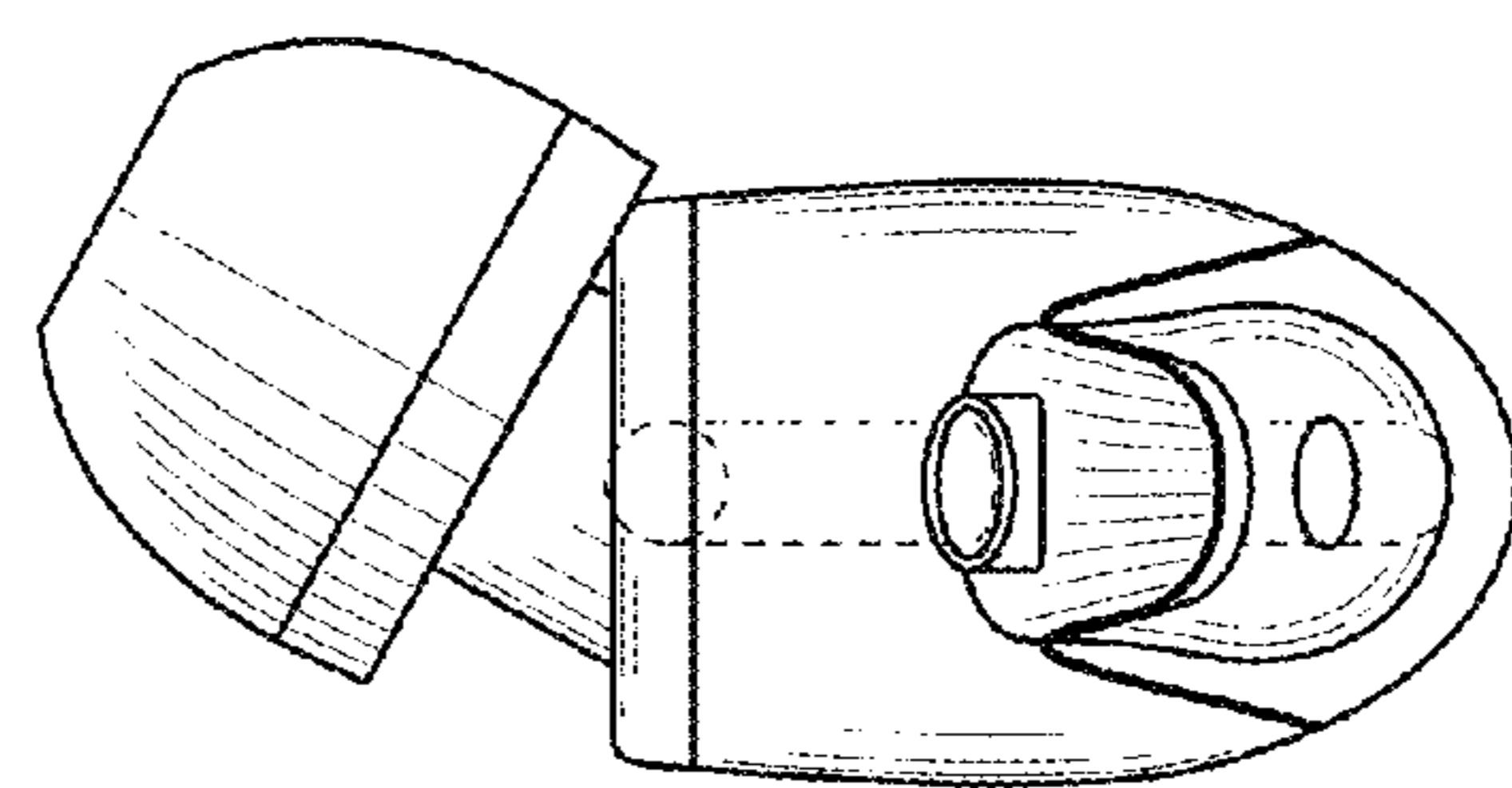

FIG. 7