



US00D747694S

(12) **United States Design Patent**
Tom

(10) **Patent No.:** **US D747,694 S**
(45) **Date of Patent:** **** Jan. 19, 2016**

(54) **HANDSET**

(71) Applicant: **Nokia Corporation**, Espoo (FI)

(72) Inventor: **Travis Tom**, Newbury Park, CA (US)

(73) Assignee: **MICROSOFT MOBILE OY**, Espoo (FI)

(**) Term: **14 Years**

(21) Appl. No.: **29/461,353**

(22) Filed: **Jul. 22, 2013**

(51) **LOC (10) Cl.** **14-03**

(52) **U.S. Cl.**
USPC **D14/138 G**

(58) **Field of Classification Search**
USPC D14/138 G, 248
CPC ... H04M 1/02; H04M 1/0202; H04M 1/0235;
H04M 1/0237; H04M 1/0239; H04M 2250/22
See application file for complete search history.

(56) **References Cited**

U.S. PATENT DOCUMENTS

D665,766 S	8/2012	Eguchi	
D666,980 S	9/2012	Faoro	
D676,459 S *	2/2013	Hofer et al. D14/496
D680,512 S	4/2013	Lu et al.	
D680,513 S	4/2013	Lu et al.	

(Continued)

OTHER PUBLICATIONS

Nokia X+, announced Feb. 2014, [online], [site visited May 18, 2015]. Available from Internet, <URL: http://www.gsmarena.com/nokia_x+-6147.php>.*

(Continued)

Primary Examiner — Rosemary K Tarcza

Assistant Examiner — Sanjeev Paul

(74) *Attorney, Agent, or Firm* — Banner & Witcoff, Ltd.

(57) **CLAIM**

The ornamental design for a handset, as shown and described.

DESCRIPTION

FIG. 1 is a front perspective view of a handset showing my new design;

FIG. 2 is a front view thereof;

FIG. 3 is a rear view thereof;

FIG. 4 is a left side view thereof;

FIG. 5 is a right side view thereof;

FIG. 6 is a top view thereof;

FIG. 7 is a bottom view thereof;

FIG. 8 is a front perspective view of a second handset showing my new design;

FIG. 9 is a front view thereof;

FIG. 10 is a rear view thereof;

FIG. 11 is a left side view thereof;

FIG. 12 is a right side view thereof;

FIG. 13 is a top view thereof;

FIG. 14 is a bottom view thereof;

FIG. 15 is a front perspective view of a handset showing an alternative embodiment;

FIG. 16 is a front view thereof;

FIG. 17 is a rear view thereof;

FIG. 18 is a left side view thereof;

FIG. 19 is a right side view thereof;

FIG. 20 is a top view thereof; and,

FIG. 21 is a bottom view thereof.

The broken line showing of the handset in FIGS. 1-7 are for illustrative purposes only and form no part of the claimed design. The contrast in shading in FIGS. 15-21 represent a contrast in appearance only and does not represent any particular color, material, texture or finish.

1 Claim, 15 Drawing Sheets

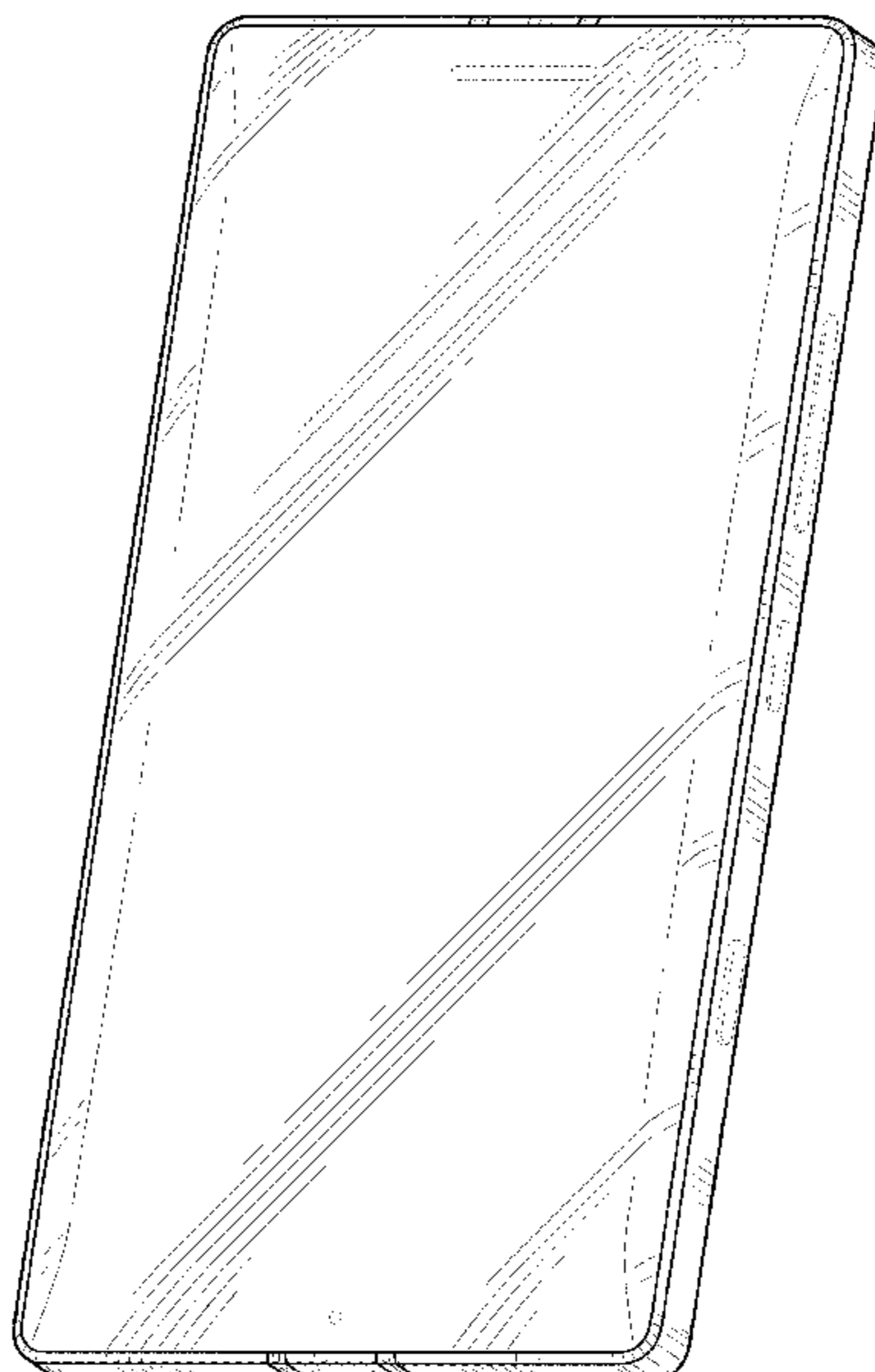

(56)

References Cited

U.S. PATENT DOCUMENTS

D689,840 S 9/2013 Lu
 D692,872 S * 11/2013 Hofer et al. D14/248
 D693,325 S * 11/2013 Lee D14/138 G
 D693,787 S * 11/2013 Reivo et al. D14/138 G
 D700,589 S * 3/2014 Yoo et al. D14/138 G
 D703,178 S * 4/2014 Park et al. D14/138 G
 D703,179 S * 4/2014 Choe et al. D14/138 G
 D703,632 S * 4/2014 Lim et al. D14/138 G
 D707,214 S * 6/2014 Reivo et al. D14/248
 D707,649 S * 6/2014 Choi et al. D14/138 G
 D708,161 S * 7/2014 Ishida D14/138 G
 D709,850 S * 7/2014 Kim et al. D14/138 G
 D716,248 S * 10/2014 Hill et al. D14/138 G
 D716,746 S * 11/2014 Du et al. D14/138 G
 D716,747 S * 11/2014 Kleiner et al. D14/138 G
 D717,263 S * 11/2014 Wozniak D14/138 G
 D717,758 S * 11/2014 Kim D14/138 G
 D718,267 S * 11/2014 Hu D14/138 G
 D720,324 S * 12/2014 Wang et al. D14/138 G
 D721,669 S * 1/2015 Kleiner et al. D14/138 G

D722,038 S * 2/2015 Cheng et al. D14/138 G
 D722,580 S * 2/2015 Dhondt D14/138 G
 D723,493 S * 3/2015 Weng D14/138 G
 D724,044 S * 3/2015 Reivo et al. D14/138 G
 D729,189 S * 5/2015 Kangasmaa et al. D14/138 G
 2011/0143769 A1 * 6/2011 Jones et al. 455/456.1

OTHER PUBLICATIONS

Nokia Lumia 925, announced May 2013, [online], [site visited May 18, 2015]. Available from Internet, <URL: http://www.gsmarena.com/nokia_lumia_925-5451.php>.*
 Nokia Lumia 928, announced Apr. 2013, [online], [site visited May 18, 2015]. Available from Internet, <URL: http://www.gsmarena.com/nokia_lumia_928-5437.php>.*
 Sony Xperia C, announced Jun. 2013, [online], [site visited May 18, 2015]. Available from Internet, <URL: http://www.gsmarena.com/sony_xperia_c-5541.php>.*
 Sony Xperia ion LTE, announced Jan. 2012, [online], [site visited May 18, 2015]. Available from Internet, <URL: http://www.gsmarena.com/sony_xperia_ion_lte-4412.php>.*

* cited by examiner

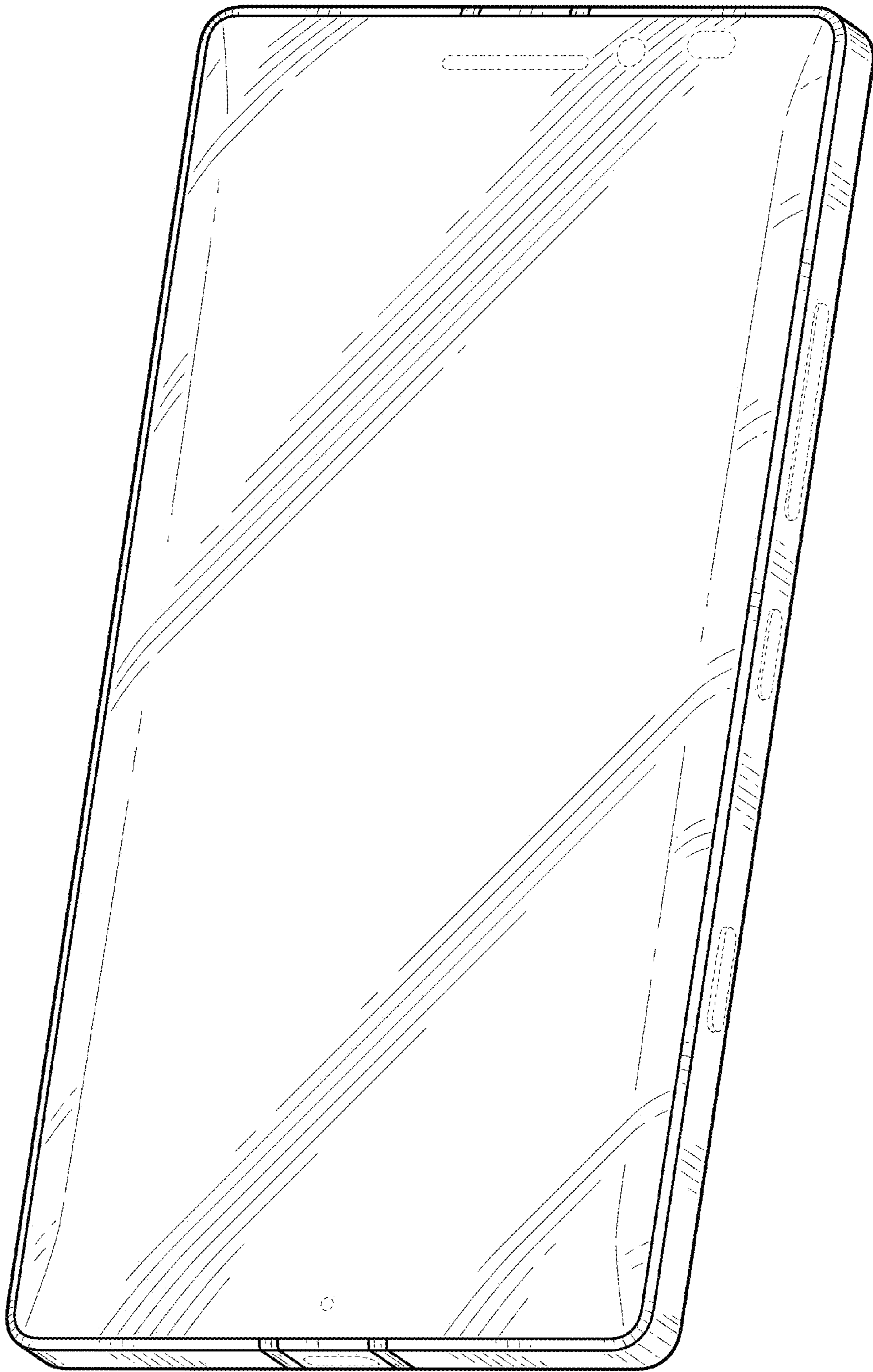

FIG. 1

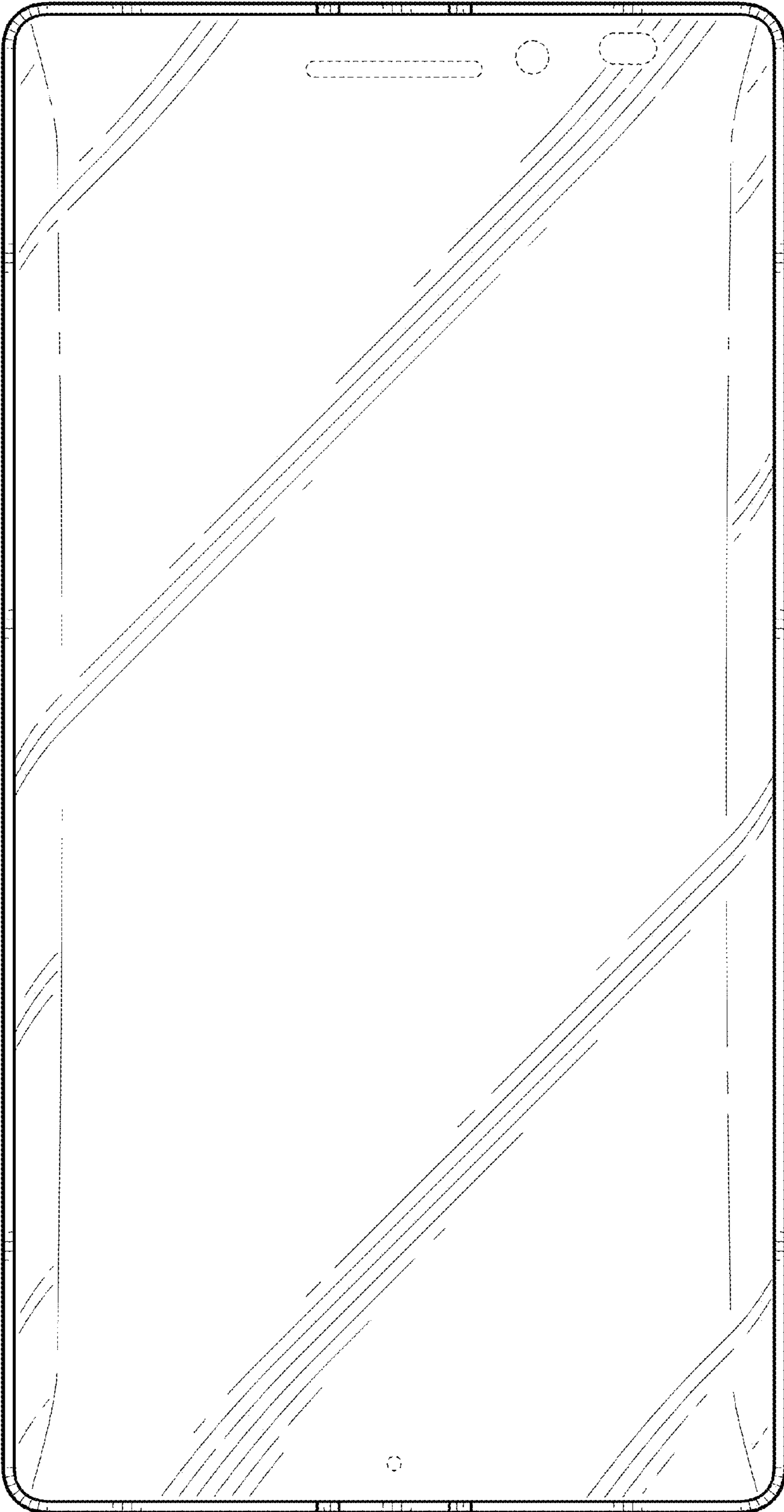

FIG. 2

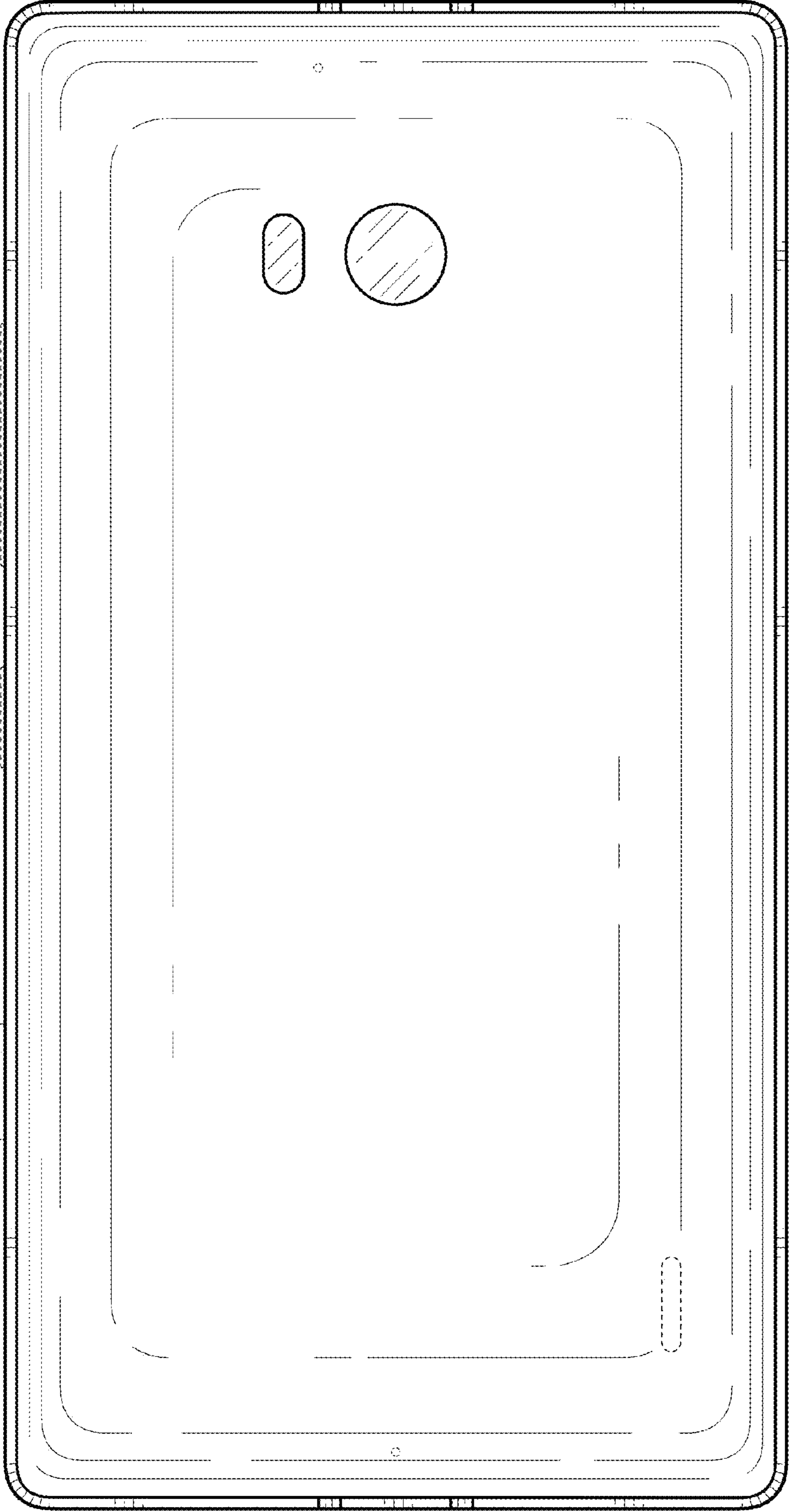

FIG. 3

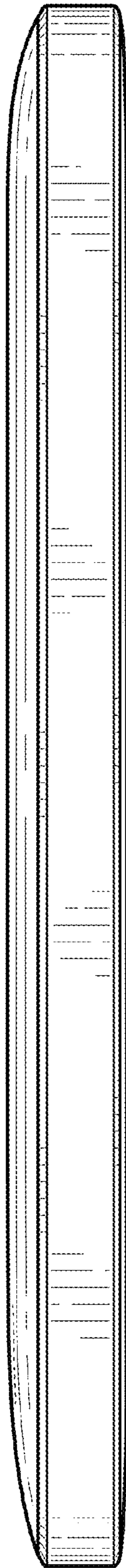

FIG. 4

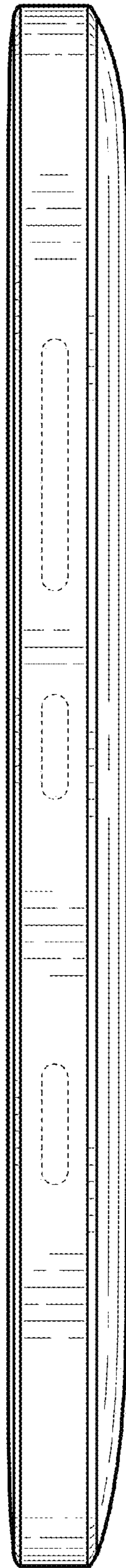

FIG. 5

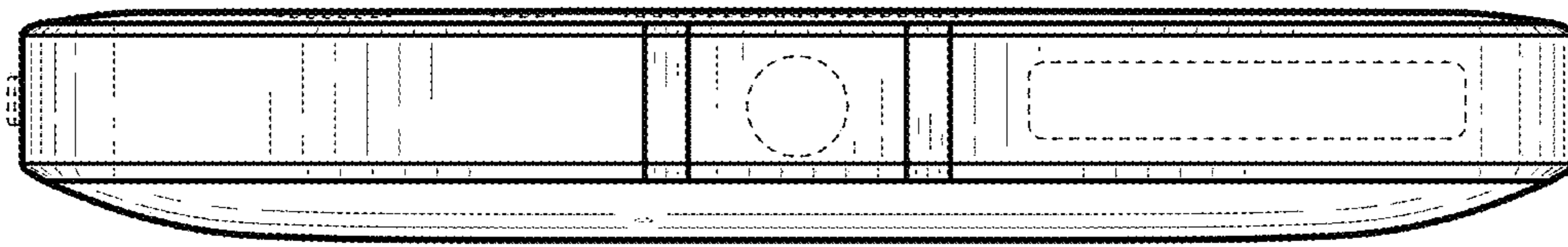

FIG. 6

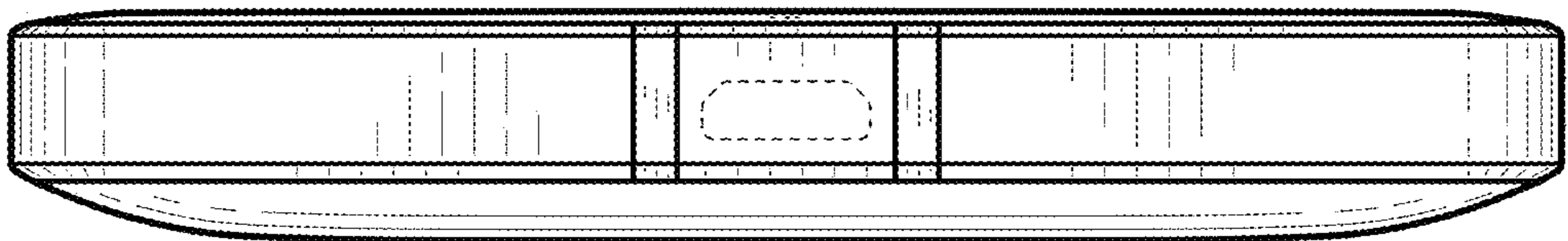

FIG. 7

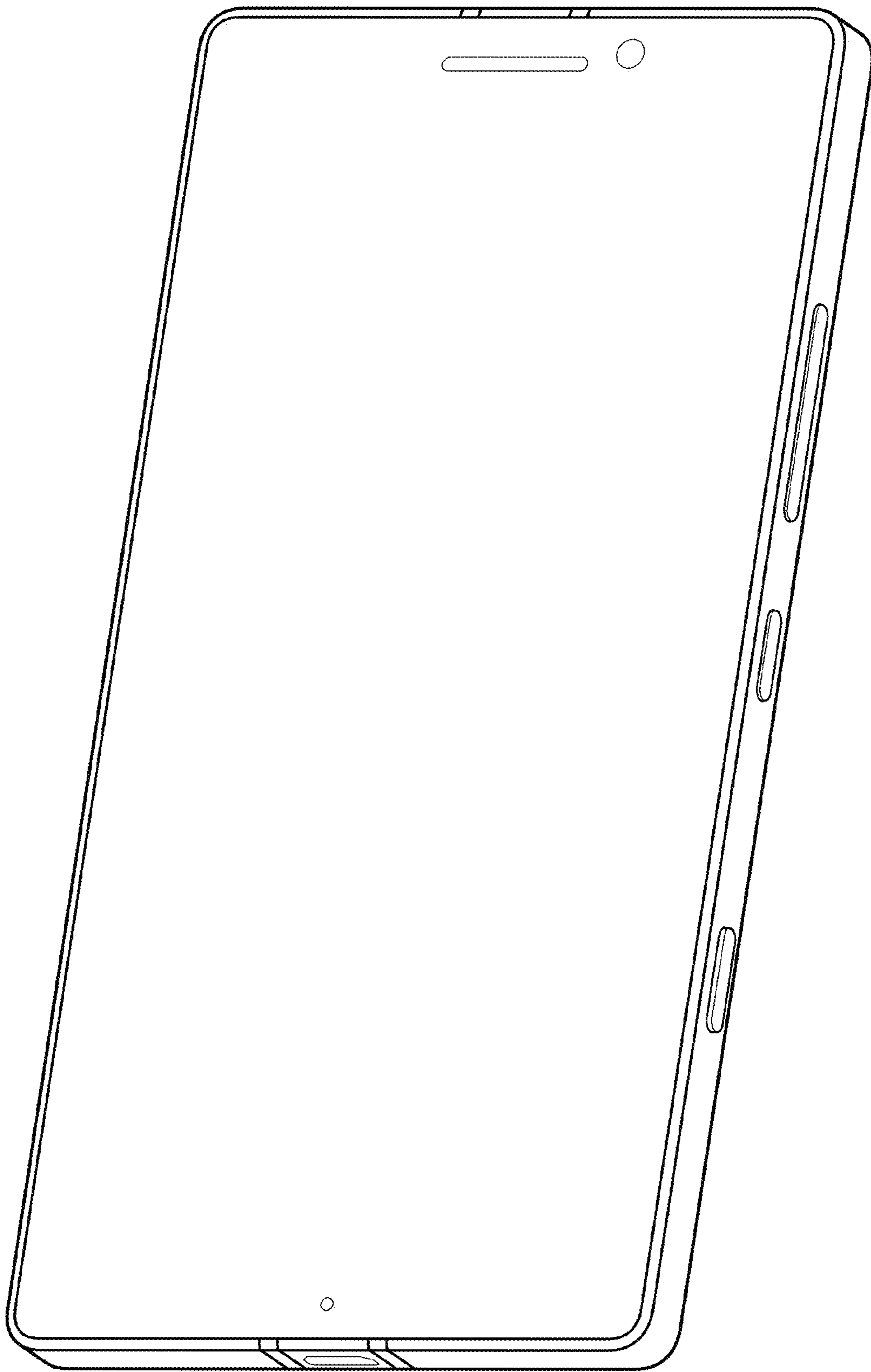

FIG. 8

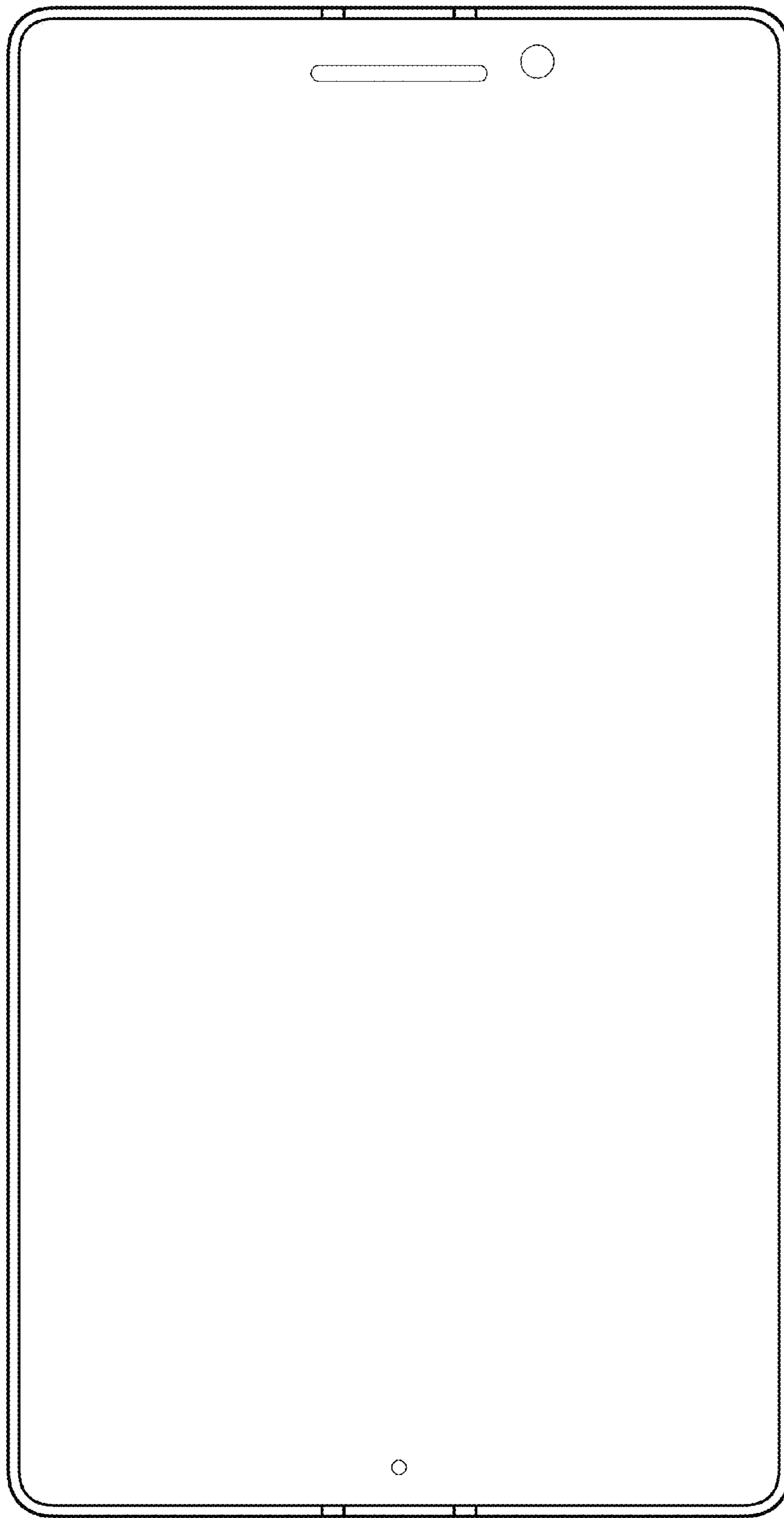

FIG. 9

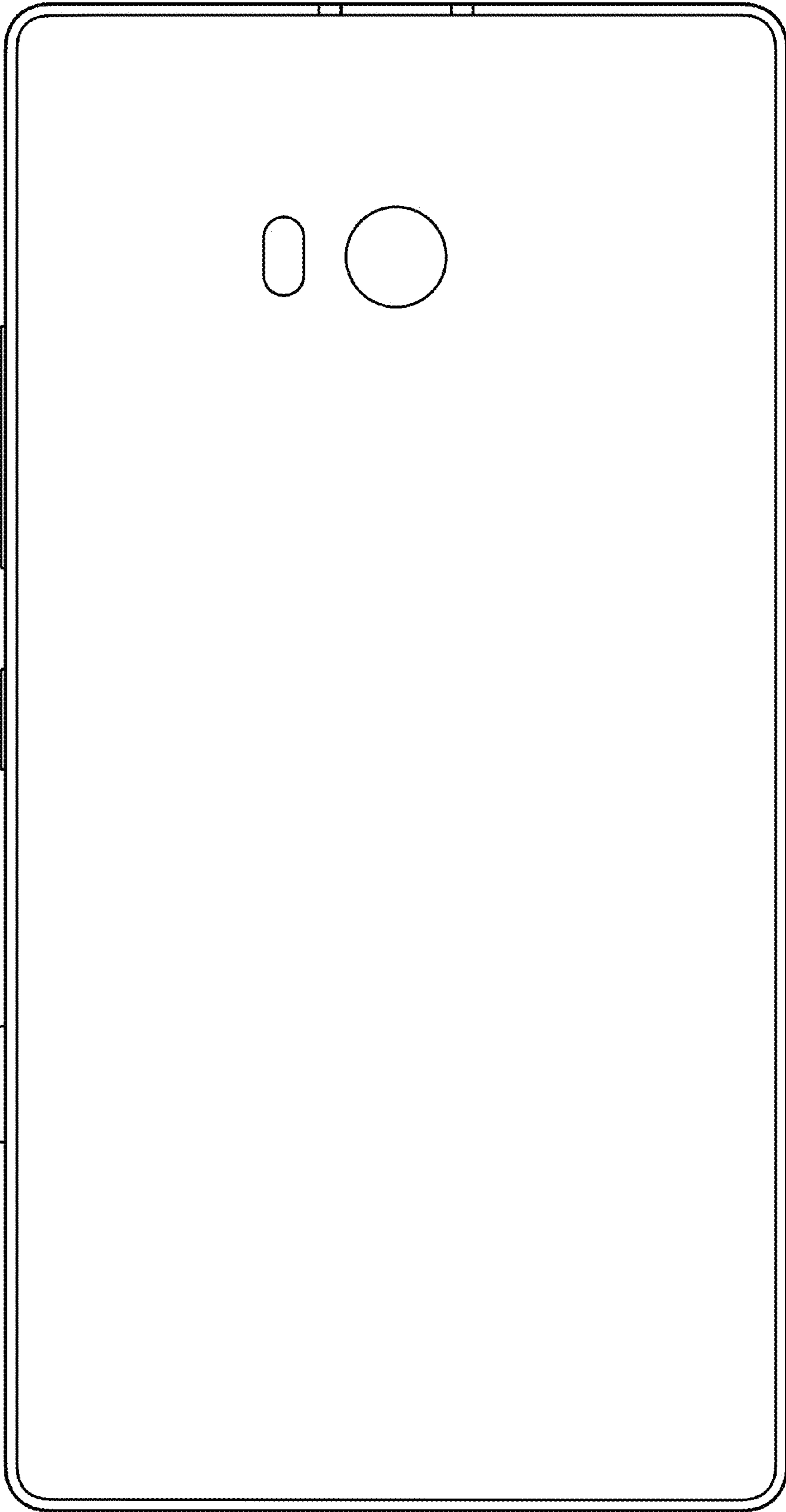

FIG. 10

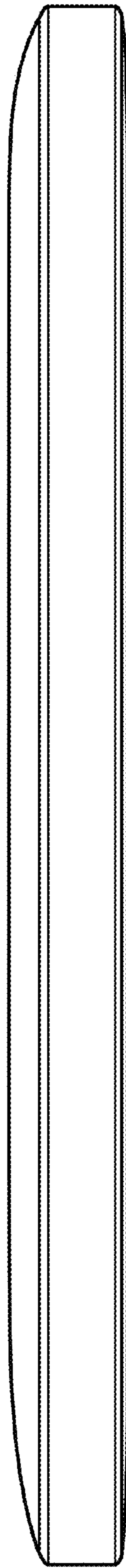

FIG. 11

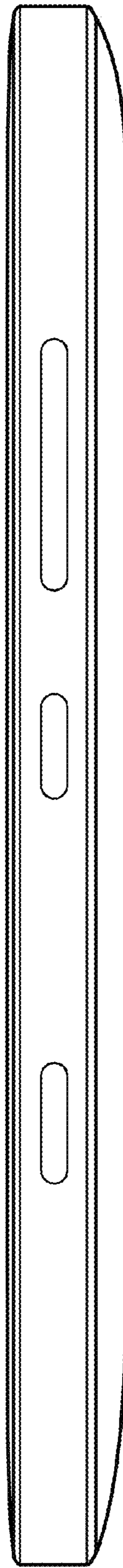

FIG. 12

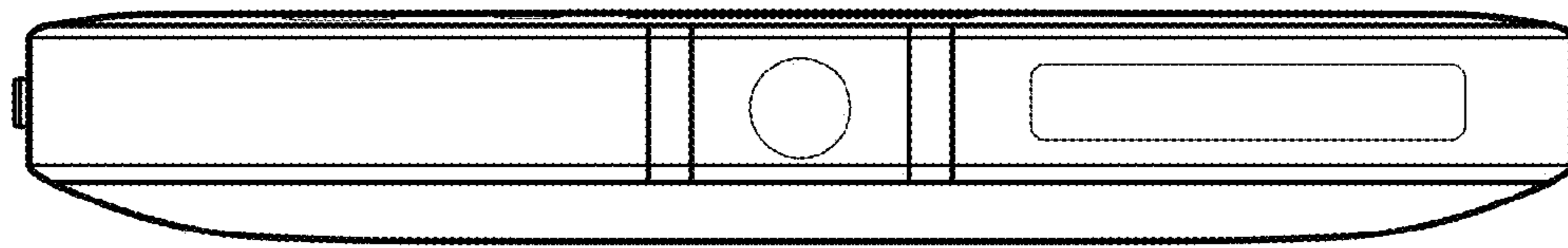

FIG. 13

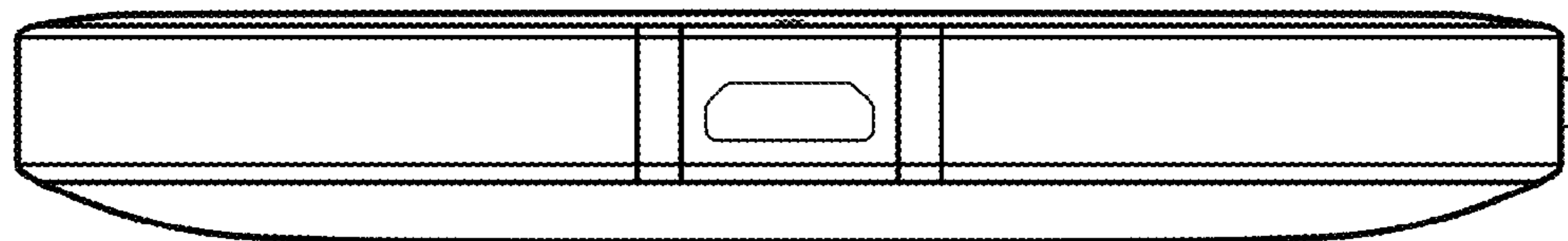

FIG. 14

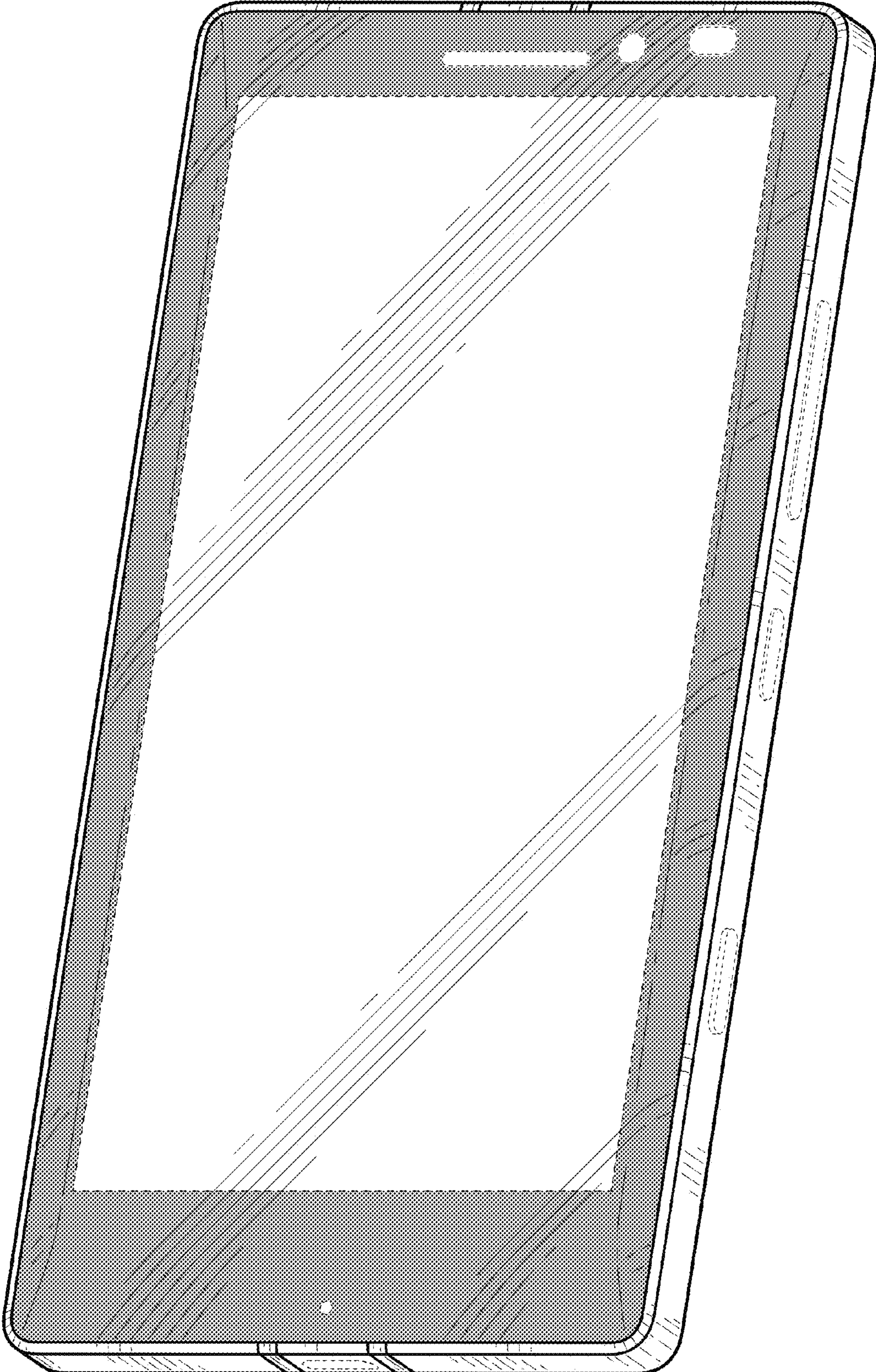

FIG. 15

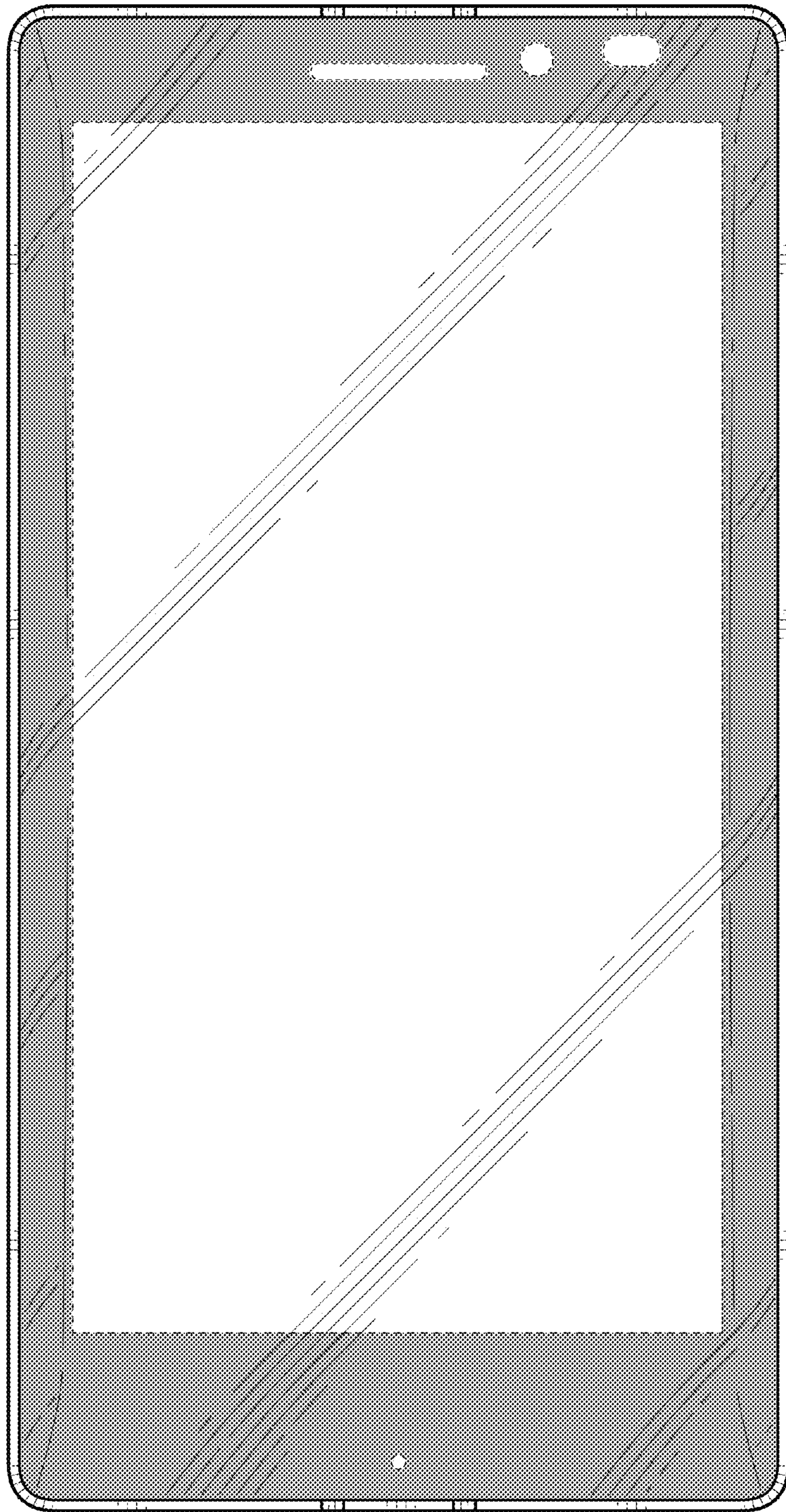

FIG. 16

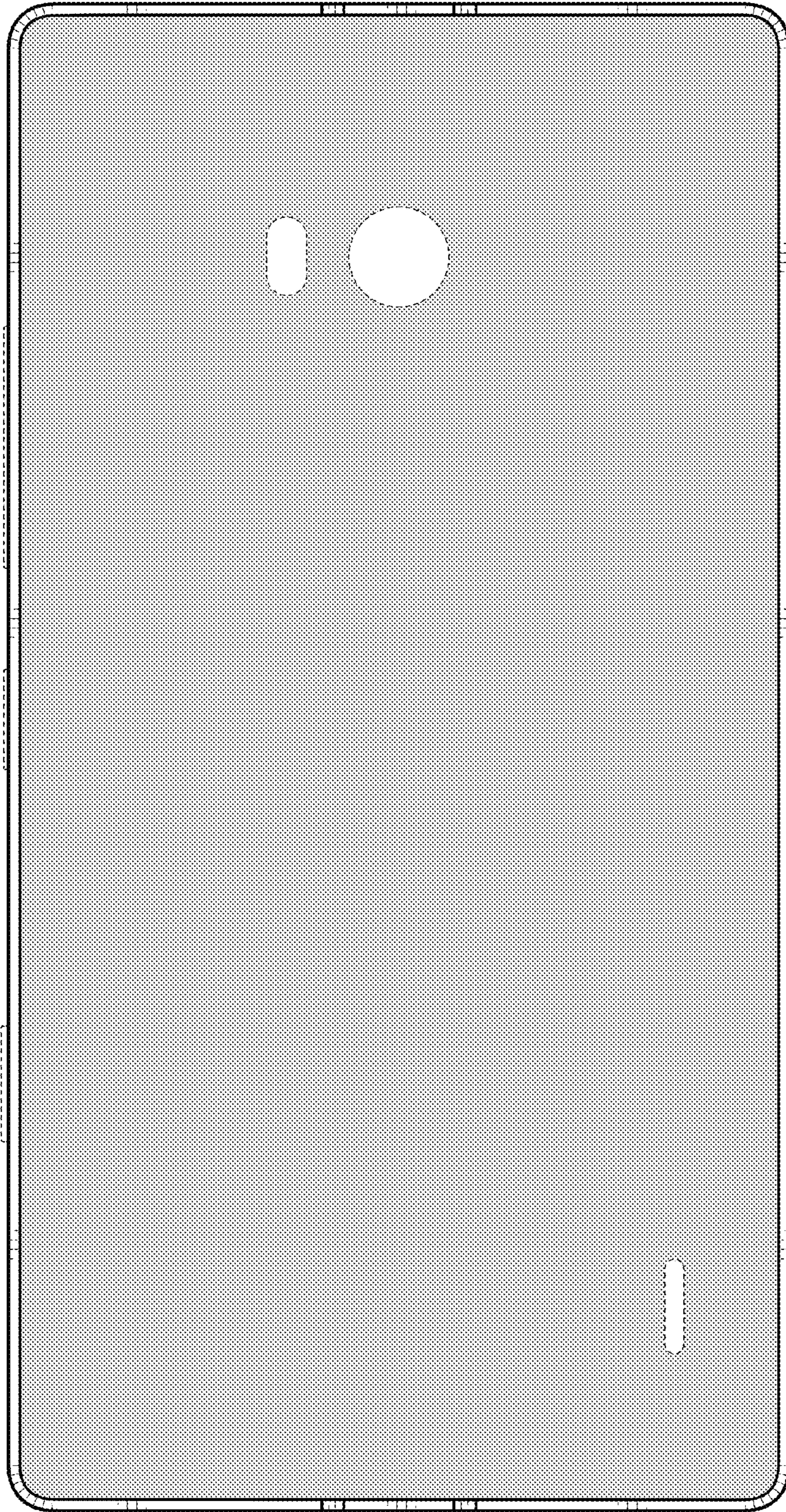

FIG. 17

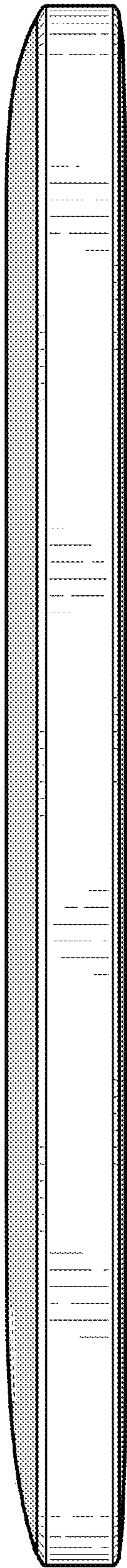

FIG. 18

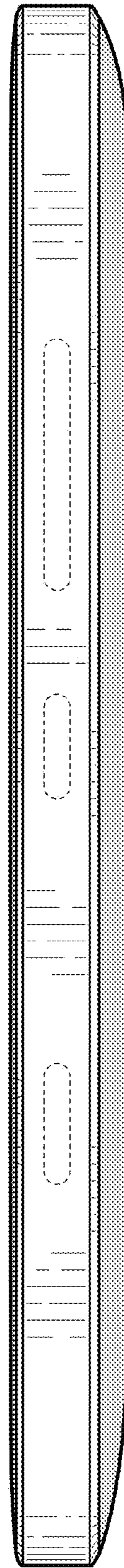

FIG. 19

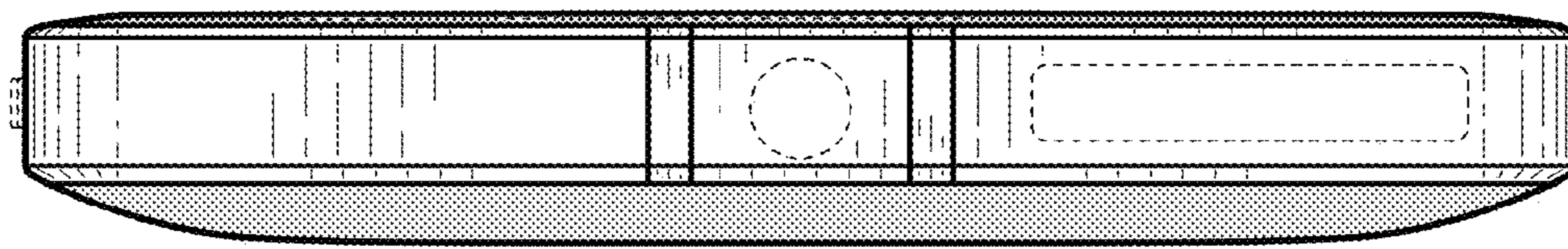

FIG. 20

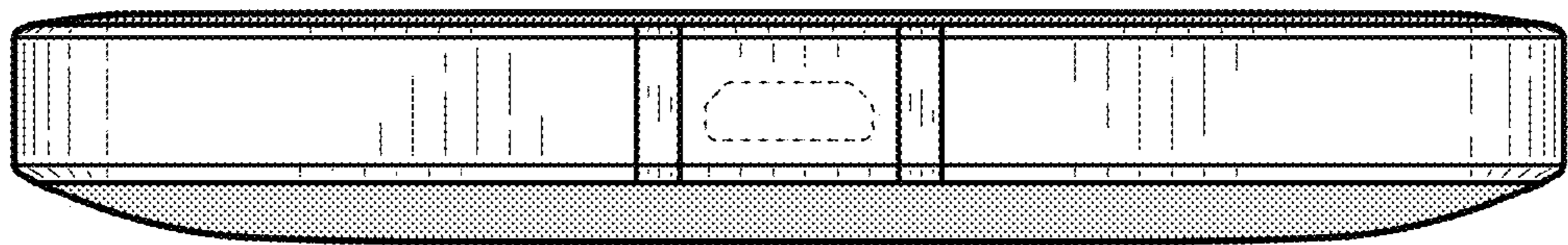

FIG. 21