



US00D747612S

(12) **United States Design Patent**  
**Jensen**

(10) **Patent No.:** **US D747,612 S**  
(45) **Date of Patent:** **\*\* Jan. 19, 2016**

(54) **PILLOW**

(71) Applicant: **Gemma Jensen**, Cheshire (GB)

(72) Inventor: **Gemma Jensen**, Cheshire (GB)

(\*\*) Term: **14 Years**

(21) Appl. No.: **29/475,770**

(22) Filed: **Dec. 6, 2013**

(30) **Foreign Application Priority Data**

Jun. 6, 2013 (EM) ..... 002250969-0005

(51) **LOC (10) Cl.** ..... **06-09**

(52) **U.S. Cl.**  
USPC ..... **D6/598**; D6/601

(58) **Field of Classification Search**  
USPC ..... D6/351, 358, 359, 388, 512, 563, 564,  
D6/595, 596, 597, 598, 601, 604, 715, 716,  
D6/716.1; D21/398, 408, 438, 439, 440,  
D21/576, 606, 803, 804, 805, 808, 809;  
5/482, 630, 631, 632, 633, 635, 636,  
5/639, 652; 446/268, 269; D24/183;  
297/393, 397, 482

See application file for complete search history.

(56) **References Cited**

**U.S. PATENT DOCUMENTS**

D204,443 S 4/1966 Wood  
4,876,755 A \* 10/1989 Parrish ..... 297/284.3  
D308,788 S 6/1990 Boehm  
4,951,998 A 8/1990 McClain  
5,114,185 A \* 5/1992 Reedom ..... 280/801.1

(Continued)

**FOREIGN PATENT DOCUMENTS**

CN 102048412 5/2011  
DE 202006005501 8/2006

(Continued)

**OTHER PUBLICATIONS**

Seat Pets, Penguin [online]. Belt Buddies/ As Seen on TV. [retrieved on Nov. 18, 2014]. Retrieved from the Internet<<http://www.aliexpress.com/item/Seat-Pets-Tan-Blue-Cat-penguin-Car-Toy-Buckle-up-snuggle-up-and-go-for-a/1914507520.html>>.\*

(Continued)

*Primary Examiner* — Eric Goodman

*Assistant Examiner* — Jennifer L Rempfer

(74) *Attorney, Agent, or Firm* — Swanson & Bratschun, L.L.C.

(57) **CLAIM**

The ornamental design for a pillow, as shown and described.

**DESCRIPTION**

FIG. 1 is a left side perspective view of a pillow showing my new design, the right side view being a mirror image thereof; FIG. 2 is a front perspective view of the pillow of FIG. 1; FIG. 3 is a left side perspective view of the pillow of FIG. 1; FIG. 4 is a bottom perspective view of the pillow of FIG. 1; FIG. 5 is a top, rear, left side perspective view of the pillow of FIG. 1 with a rear seam partially open revealing hook and loop fastener strips and semi-cylindrical cushions; FIG. 6 is a bottom, front perspective view of the pillow of FIG. 1 in an alternate position of use with the rear seam fully open and the semi-circular cushion members separated; and, FIG. 7 is a bottom, left perspective view of the pillow of FIG. 1 showing it in use with a seat belt received between the semi-cylindrical cushions.

All broken lines in all figures are included for the purpose of illustrating environment and unclaimed features of the design and form not part of the claimed design.

**1 Claim, 7 Drawing Sheets**

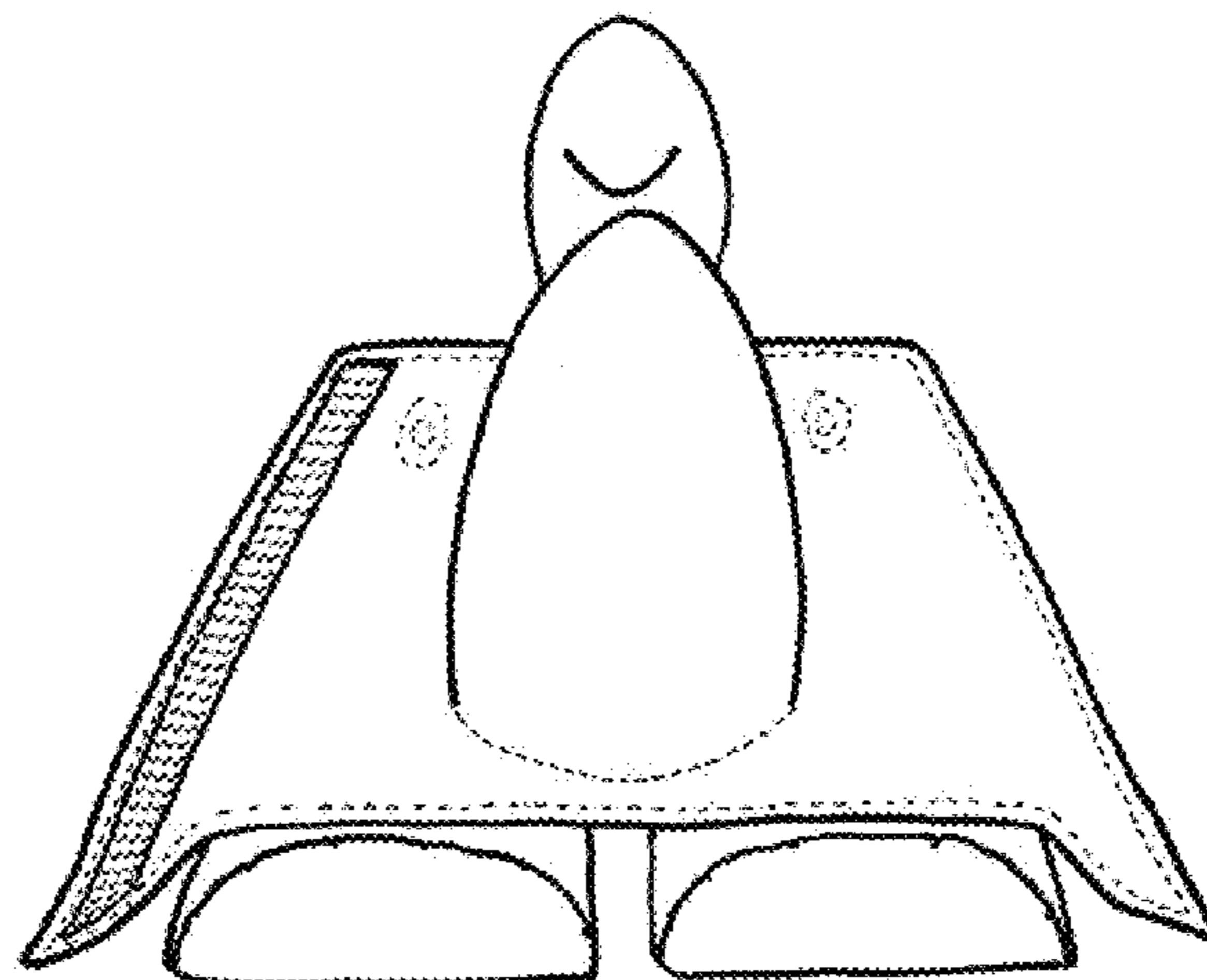
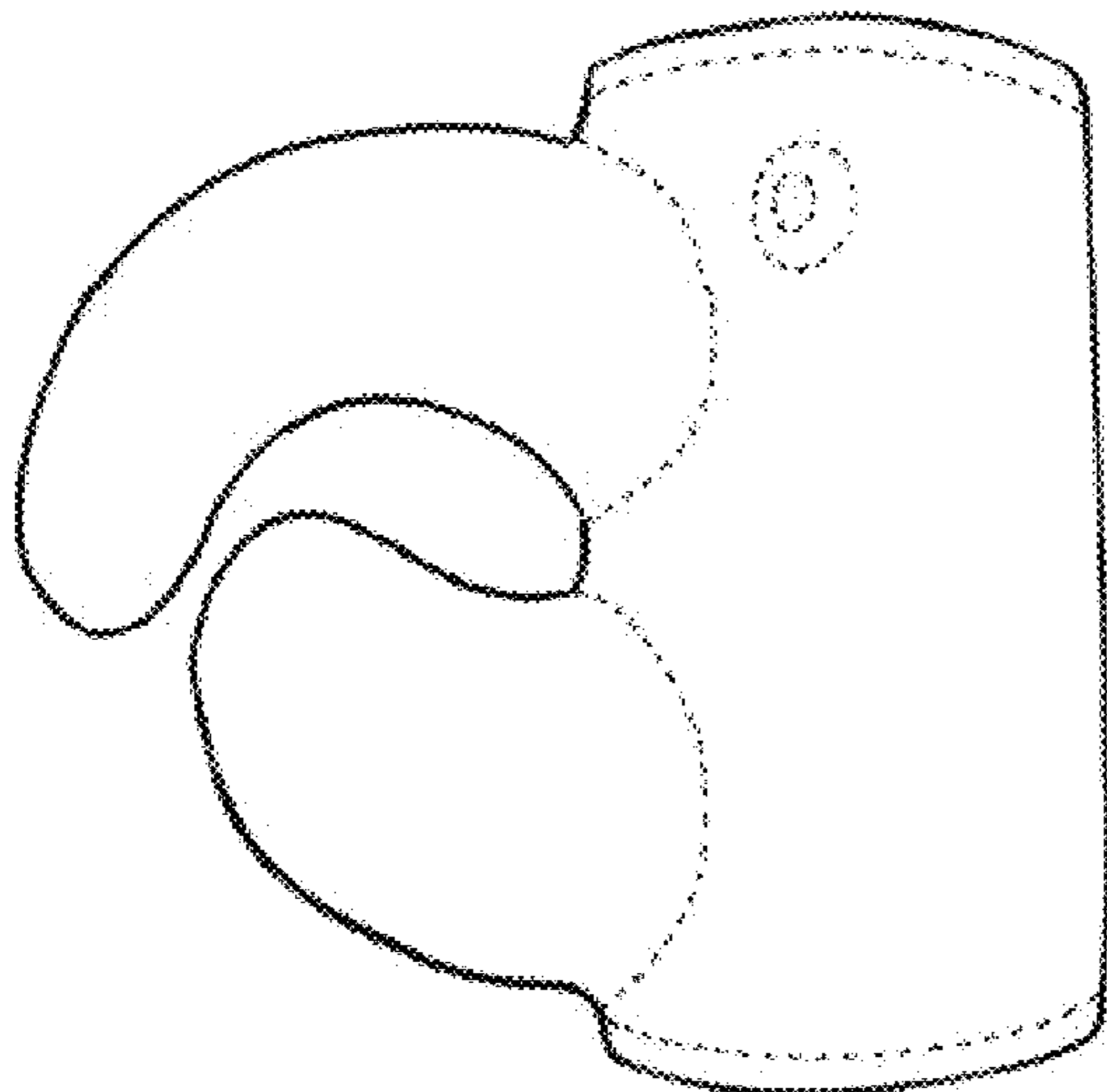

(56)

References Cited

U.S. PATENT DOCUMENTS

D343,756 S \* 2/1994 Sher ..... D6/601  
 5,367,730 A \* 11/1994 Sher ..... 5/655  
 5,528,784 A 6/1996 Painter  
 5,572,757 A \* 11/1996 O'Sullivan ..... 5/636  
 D406,486 S \* 3/1999 Ogilvie ..... D6/596  
 D410,168 S 5/1999 McWhorter  
 6,073,902 A 6/2000 Hiles  
 6,394,554 B1 \* 5/2002 Hingle ..... 297/482  
 6,748,615 B1 \* 6/2004 Tiedemann ..... 5/640  
 D523,275 S 6/2006 Hawkins  
 D528,707 S \* 9/2006 Deioma ..... D30/118  
 D534,389 S \* 1/2007 Chisholm et al. .... D6/601  
 D558,839 S \* 1/2008 Kittelson et al. .... D21/606  
 7,322,061 B2 1/2008 Carroll  
 7,758,125 B2 \* 7/2010 Mittelstadt ..... 297/397  
 D652,239 S \* 1/2012 Governale ..... D6/601  
 D653,486 S 2/2012 Wood  
 D663,150 S \* 7/2012 Oberpriller ..... D6/601  
 D679,929 S \* 4/2013 DiBernardo ..... D6/601  
 D691,828 S \* 10/2013 Rosenberg ..... D6/601  
 8,708,416 B2 \* 4/2014 Stronconi ..... 297/397  
 2006/0042012 A1 3/2006 Littlehorn  
 2006/0130849 A1 \* 6/2006 Lieberman ..... 128/845

2006/0162080 A1 7/2006 Littlehorn et al.  
 2007/0052274 A1 \* 3/2007 Morphew et al. .... 297/392  
 2009/0094749 A1 4/2009 Littlehorn et al.

FOREIGN PATENT DOCUMENTS

EM 000405808-0010 9/2005  
 EM 000586086-0001 9/2006  
 FR 2837437 9/2003  
 GB 2198341 6/1988  
 GB 2060793 11/1996  
 GB 4004757 10/2007  
 JP 2000 000513 6/1998  
 WO WO 97/38611 10/1997  
 WO WO 2009/063299 5/2009

OTHER PUBLICATIONS

Seatbelt Pillows [online]. Darling Doodles Design [retrieved on Nov. 18, 2014]. Retrieved from the Internet:<<http://www.pinterest.com/pin/120752833731324938/>>.\*  
 UKIPO Search and Examination Report from GB1208001.6 dated Jun. 10, 2013.  
 International Search Report from PCT/GB2012/053062, dated Mar. 18, 2013 with Written Opinion.

\* cited by examiner

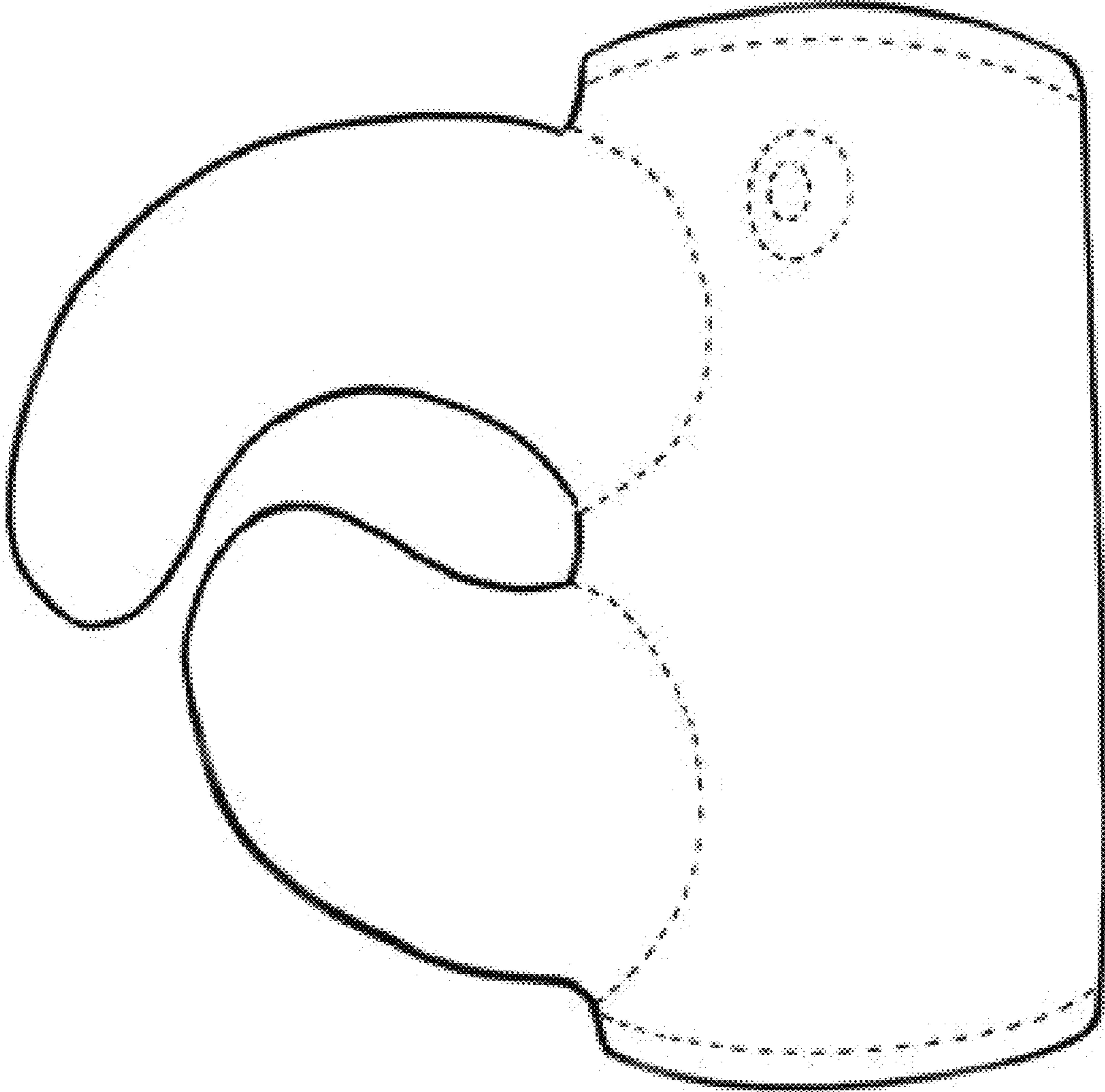

Fig. 1

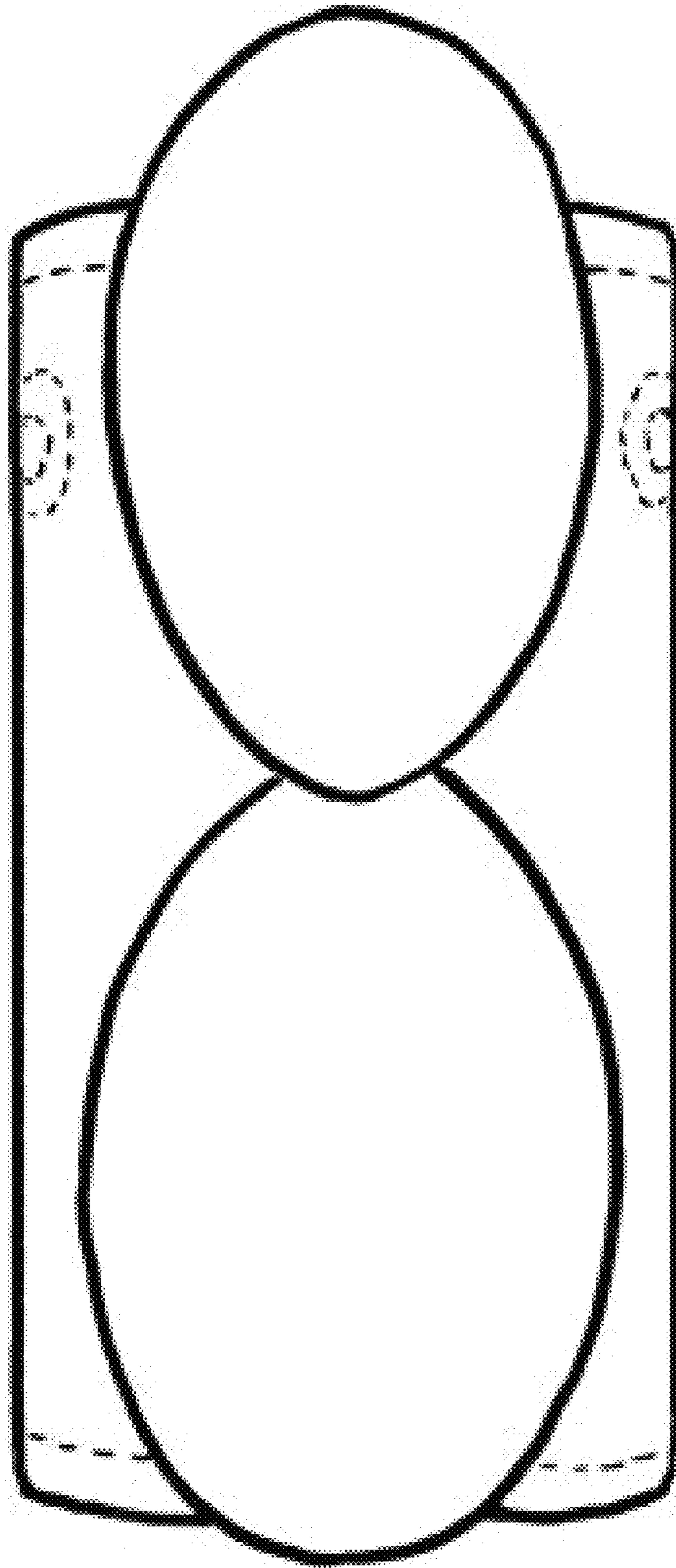

Fig. 2

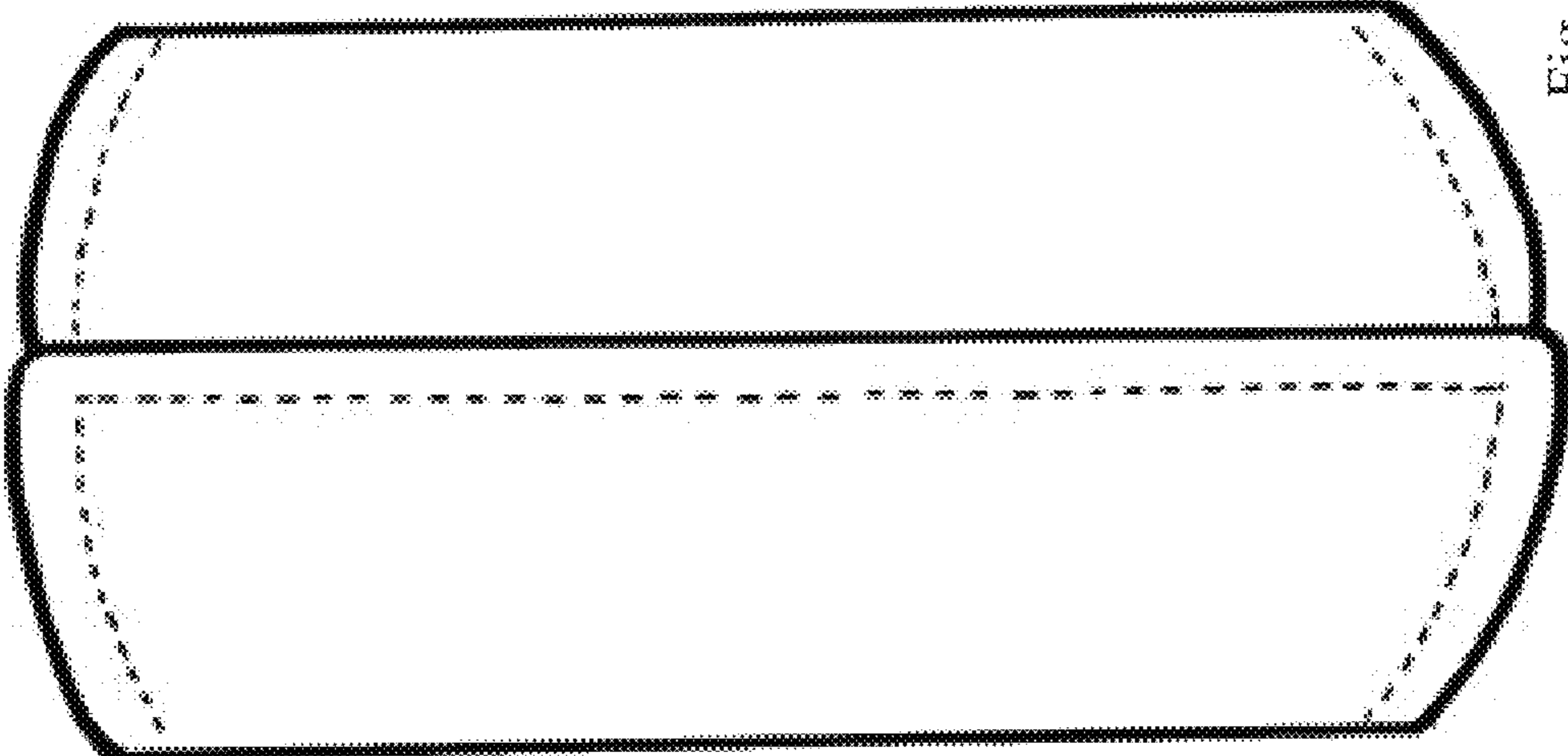

Fig. 3

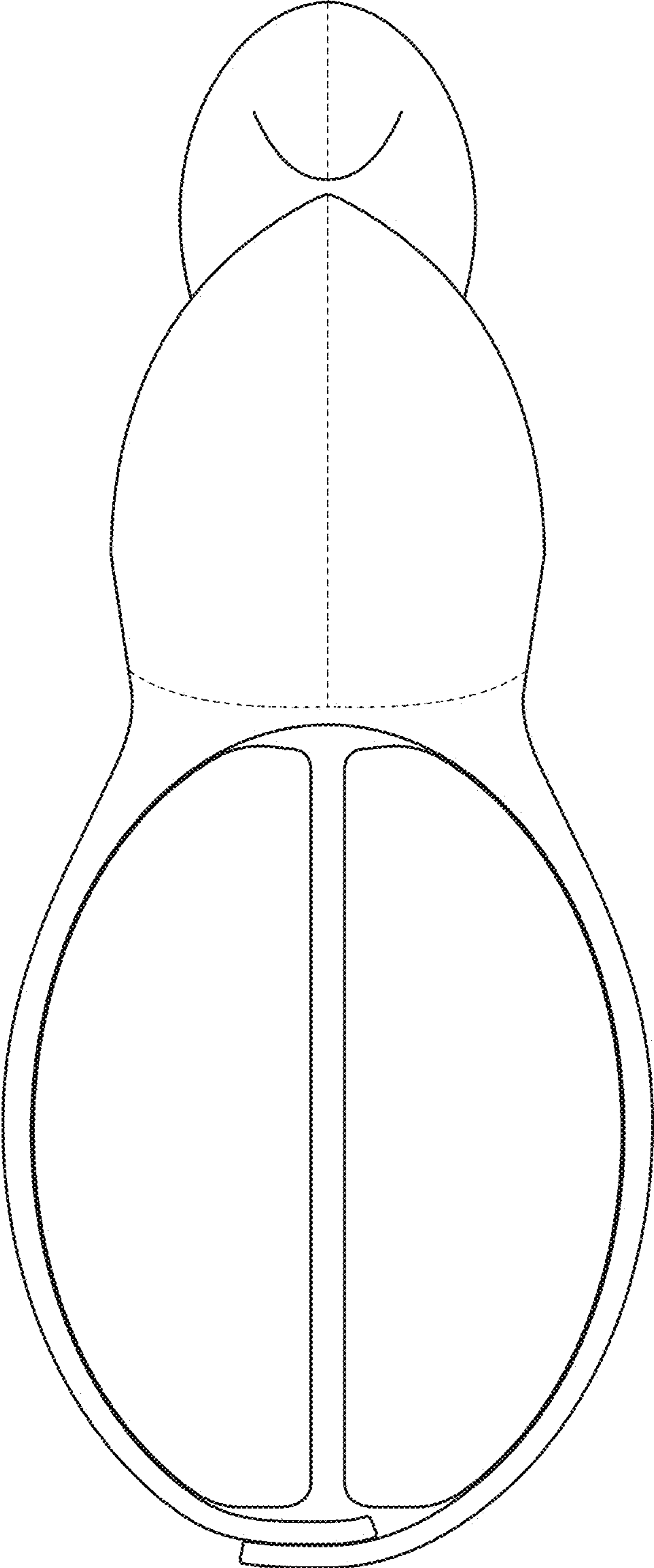

Fig. 4

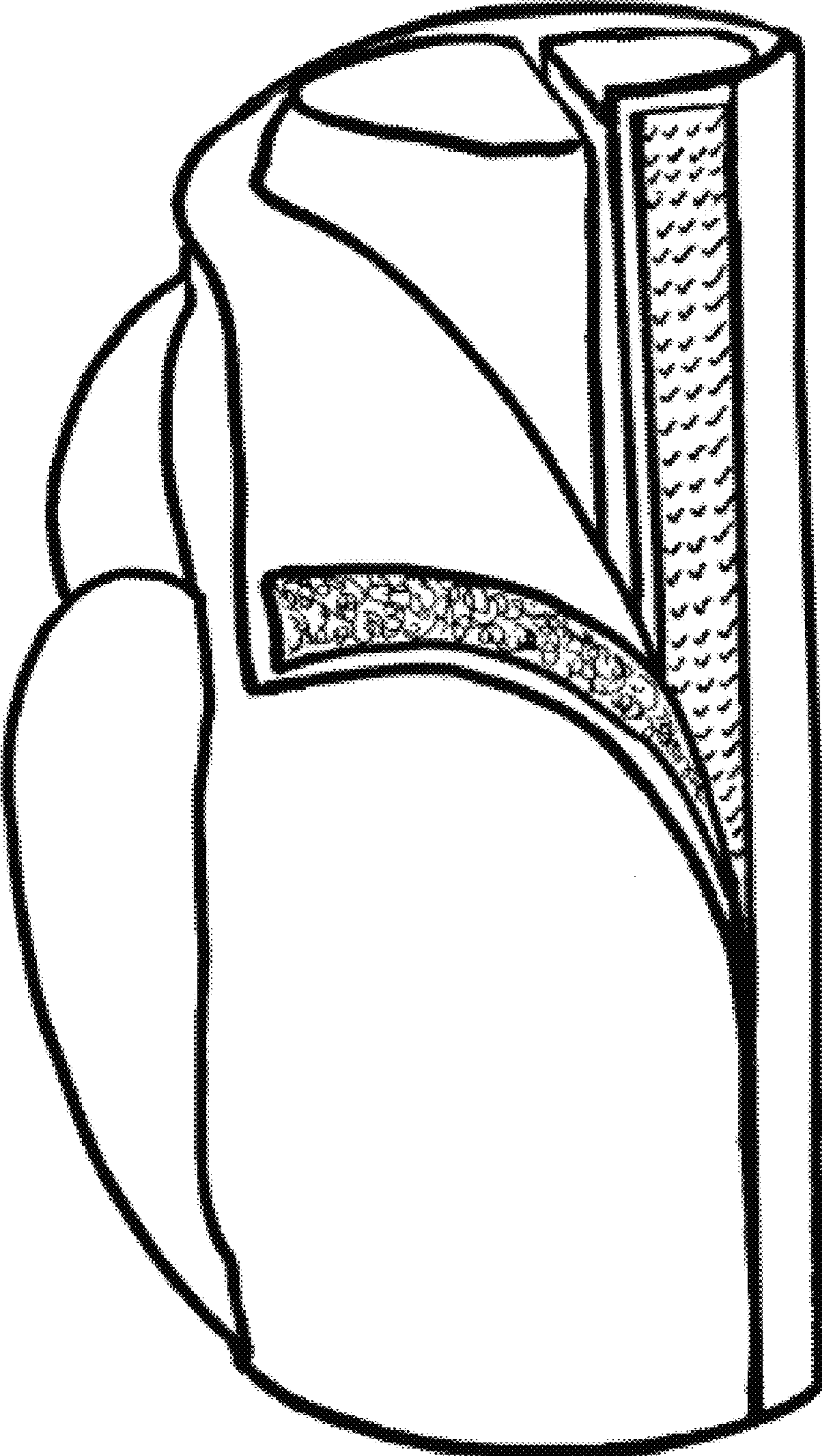

Fig. 5

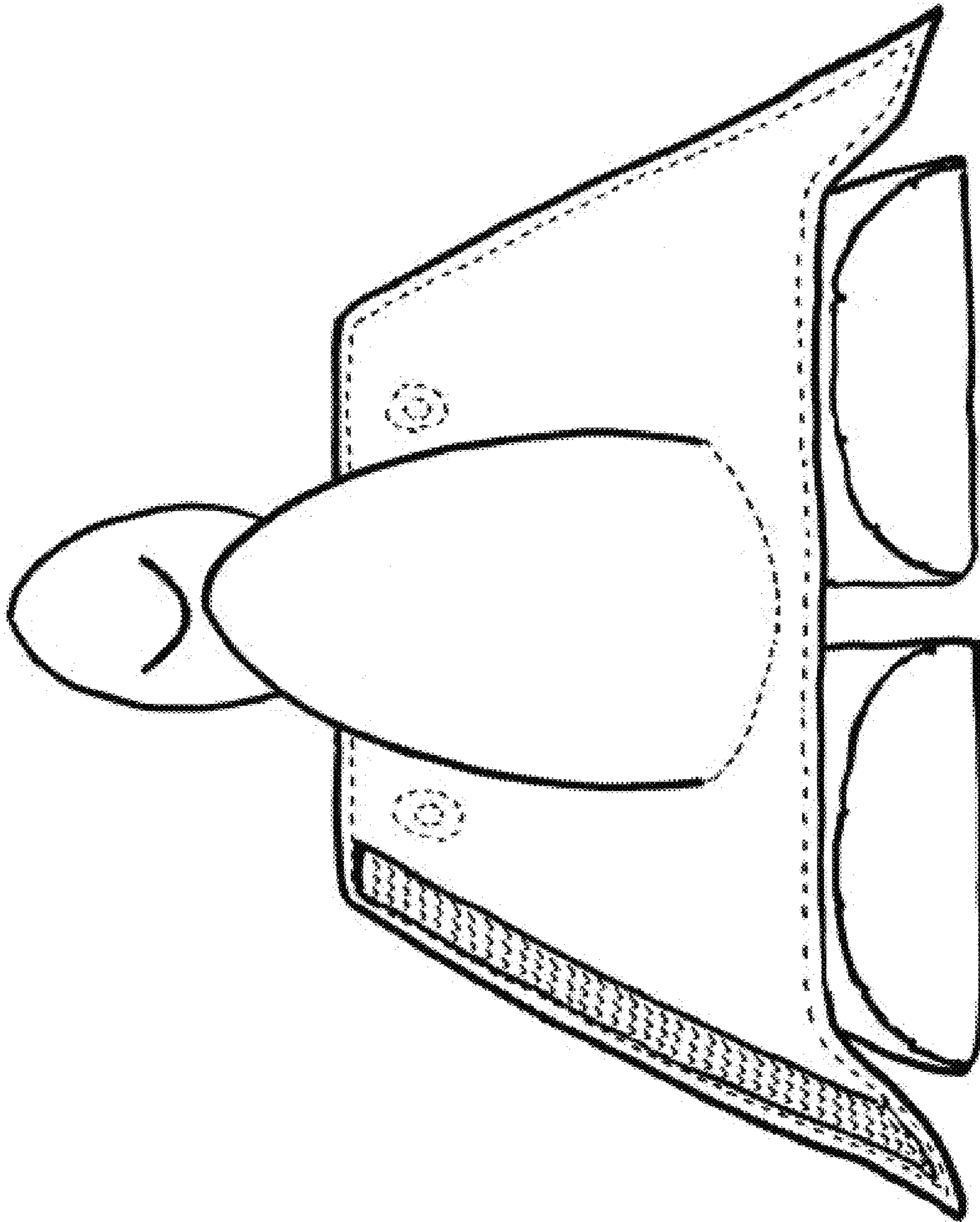

Fig. 6



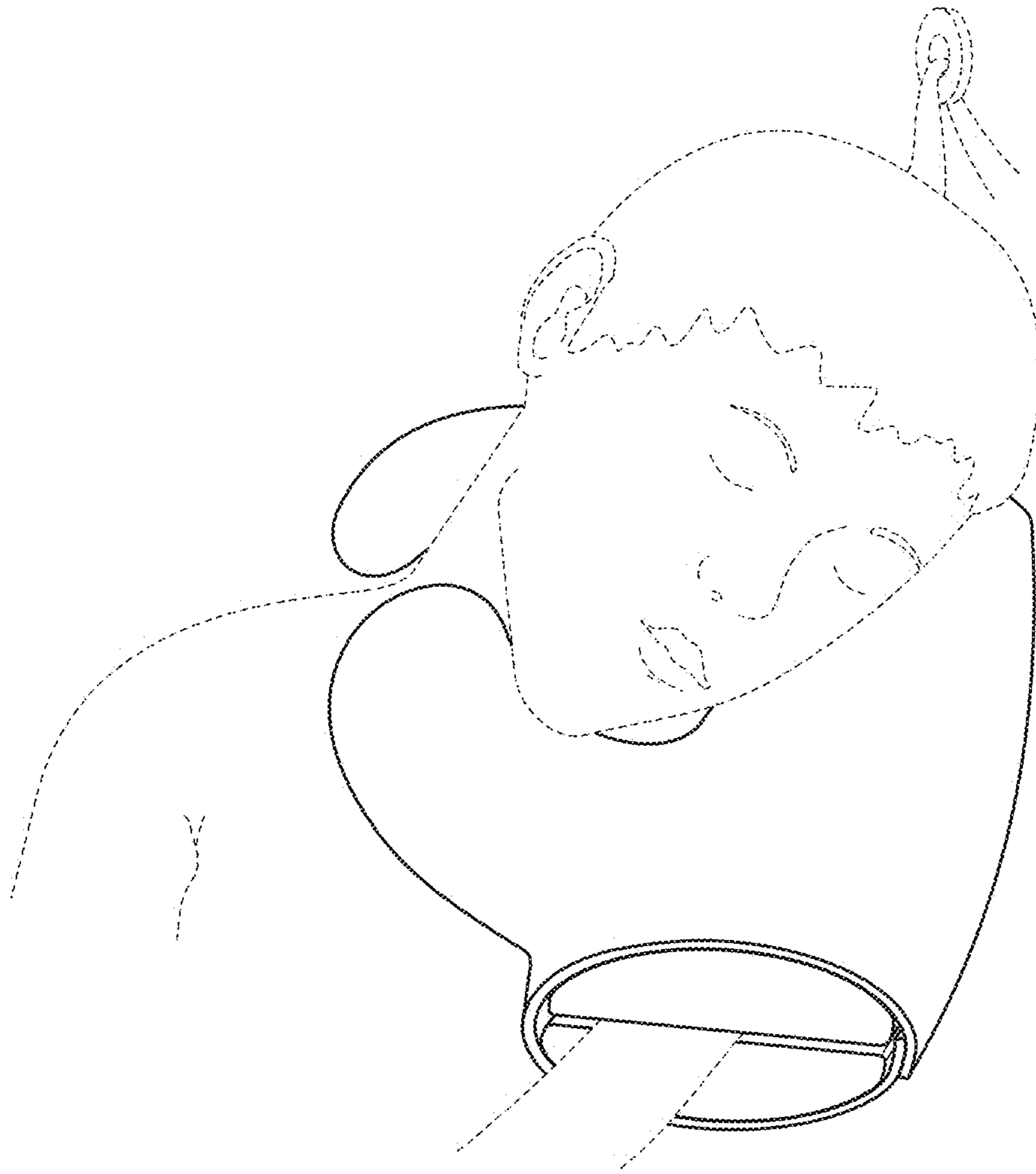

Fig. 7