



US00D747602S

(12) **United States Design Patent**
Upchurch et al.

(10) **Patent No.:** **US D747,602 S**
(45) **Date of Patent:** **** Jan. 19, 2016**

(54) **TEMPLATE FOR A PRESCRIPTION
MEDICINE CONTAINER**

FOREIGN PATENT DOCUMENTS

(71) Applicant: **AbbVie Inc.**, North Chicago, IL (US)

AU 314244 S 5/2007
AU 341384 S 3/2012

(Continued)

(72) Inventors: **Guy Upchurch**, North Chicago, IL (US); **John G. Finch**, North Chicago, IL (US); **Lewis H. Sita**, North Chicago, IL (US); **Lori K. Kim**, North Chicago, IL (US); **Alexandra C. Breban-Lopez**, North Chicago, IL (US)

OTHER PUBLICATIONS

International Search Report and Written Opinion for Application No. PCT/US2014/045459, mailed on Nov. 3, 2014, 18 pages.

(Continued)

(73) Assignee: **AbbVie Inc.**, North Chicago, IL (US)

Primary Examiner — Catheri Oliver-Garcia

(**) Term: **15 Years**

(74) *Attorney, Agent, or Firm* — Julie A. Haut; Lisa V. Mueller; Michael Best & Friedrich LLP

(21) Appl. No.: **29/529,658**

(22) Filed: **Jun. 9, 2015**

(57) **CLAIM**

We claim the ornamental design for a template for a prescription medicine container, as shown and described in the figures.

Related U.S. Application Data

(63) Continuation of application No. 29/469,106, filed on Oct. 7, 2013, now Pat. No. Des. 731,171.

DESCRIPTION

(51) **LOC (10) Cl.** **03-01**

(52) **U.S. Cl.**
USPC **D3/203.2**

(58) **Field of Classification Search**
USPC D3/201–205, 283, 315, 319; D7/541, D7/553.5, 553.1, 553.4, 553.2; 206/528–540; 220/23.8, 556, 575, 220/4.24; D24/227, 136, 230; D19/35, 75, D19/77

See application file for complete search history.

FIG. 1 is top perspective view of a template for a prescription medicine container according to one embodiment of the invention.

FIG. 2 is a top view of the template of FIG. 1.
FIG. 3 is bottom view of the template of FIG. 1.
FIG. 4 is a rear view of the template of FIG. 1.
FIG. 5 is a front view of the template of FIG. 1.
FIG. 6 is a left side view of the template of FIG. 1; and, FIG. 7 is a right side view of the template of FIG. 1.

The portions of the template shown in broken lines are included for the purpose of illustrating environment and form no part of the claimed design. The portion of the template shown in broken lines having unequal length segments illustrate the boundary of the claimed design and form no part of the claimed design.

(56) **References Cited**

U.S. PATENT DOCUMENTS

D88,285 S 11/1932 Blenker
D189,489 S 12/1960 Jackson et al.
D201,899 S 8/1965 Hancock et al.

(Continued)

1 Claim, 4 Drawing Sheets

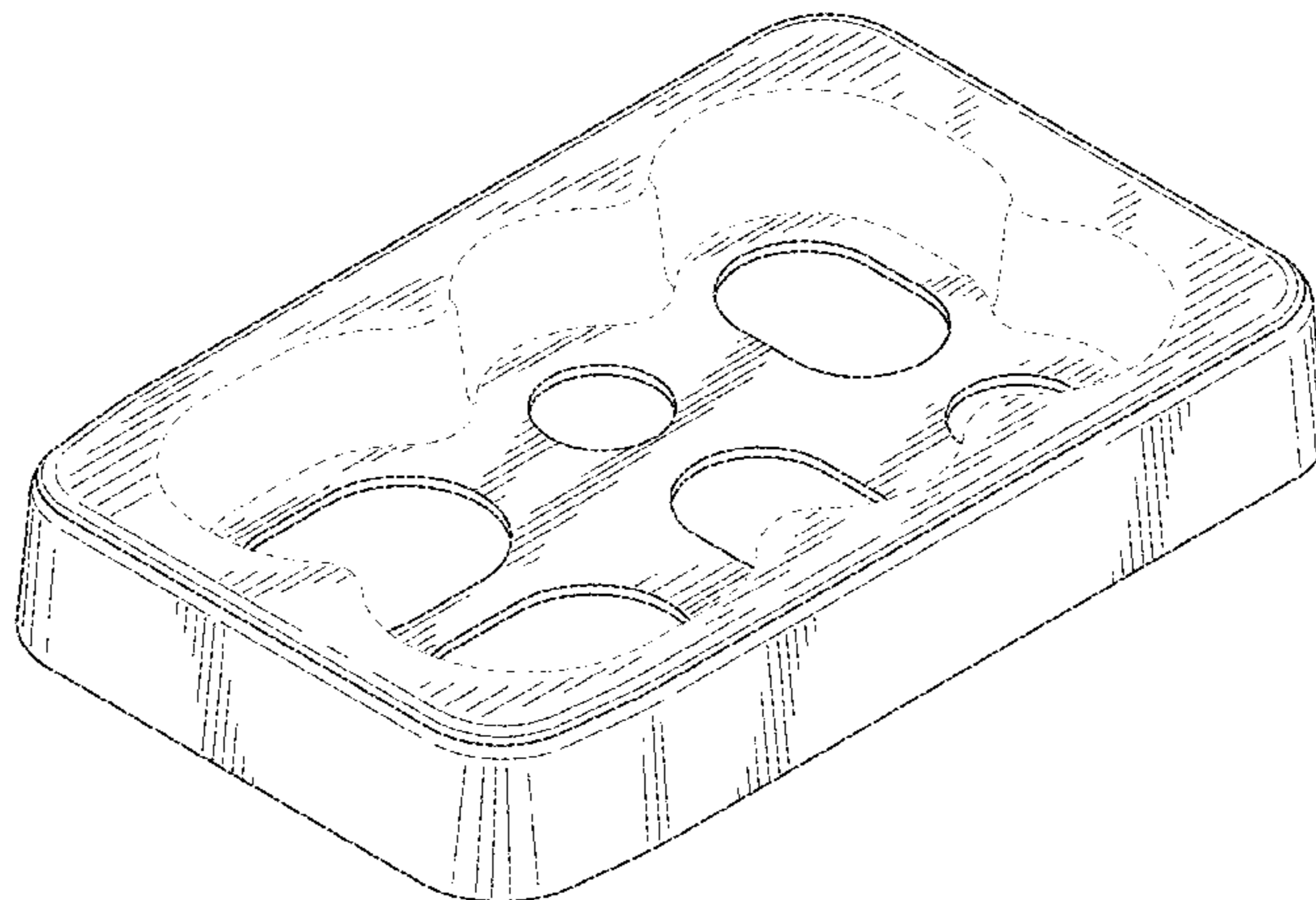

(56)

References Cited

U.S. PATENT DOCUMENTS

D205,676 S	9/1966	Kirwan et al.	7,900,772 B2	3/2011	Sack et al.
3,288,281 A	11/1966	Sparks	7,905,355 B2	3/2011	Williams-Hartman
3,305,077 A	2/1967	Greif et al.	7,926,660 B2	4/2011	Jones et al.
3,921,804 A	11/1975	Tester	D637,391 S	5/2011	Stevens et al.
RE29,705 E	7/1978	Compere	7,967,144 B2	6/2011	Sack et al.
4,120,400 A	10/1978	Kotyuk	D642,789 S	8/2011	Cooper
D254,219 S	2/1980	Papciak	7,997,411 B2	8/2011	Williams-Hartman
4,192,422 A	3/1980	Kotyuk	D650,295 S	12/2011	Schmitz et al.
D261,198 S	10/1981	Altadonna	8,132,671 B2	3/2012	Hession
D263,559 S	3/1982	Poore	D658,991 S	5/2012	Schmitz et al.
D264,538 S	5/1982	Pomroy	D659,019 S	5/2012	Specker et al.
4,340,141 A	7/1982	Fischer	D659,550 S	5/2012	Mazor
D266,147 S	9/1982	McIntosh et al.	8,205,752 B2	6/2012	Sack et al.
D267,767 S	2/1983	Storrs	D663,981 S	7/2012	Purcell
D268,130 S	3/1983	Easton	D669,311 S	10/2012	Hsu
D276,116 S	10/1984	Basil et al.	D670,178 S	11/2012	Carson et al.
D293,887 S	1/1988	Webster et al.	D673,297 S	12/2012	Hawker
4,838,444 A	6/1989	Bitel	8,342,330 B2	1/2013	Weston et al.
5,050,739 A	9/1991	Hannan et al.	8,342,331 B2	1/2013	Ziemba et al.
D320,930 S	10/1991	Richards et al.	8,403,212 B2	3/2013	Van Esch
D322,400 S	12/1991	Sorensen et al.	8,413,813 B2	4/2013	Grosskopf
D322,934 S	1/1992	Kalvelage et al.	8,420,674 B2	4/2013	Bradford
5,109,984 A	5/1992	Romick	D683,950 S	6/2013	Ernster et al.
D327,363 S	6/1992	Farb	D684,482 S	6/2013	Stevens et al.
D331,258 S	11/1992	Tarozzi	D685,272 S	7/2013	Stevens et al.
D350,478 S	9/1994	Fuller et al.	8,479,921 B2	7/2013	Ingraham
D351,995 S	11/1994	Kalvelage et al.	D688,570 S	8/2013	Logue et al.
D351,996 S	11/1994	Kalvelage	D688,571 S	8/2013	Logue et al.
5,489,025 A	2/1996	Romick	8,499,531 B2	8/2013	Benetti et al.
D370,414 S	6/1996	Lambelet et al.	D689,373 S	9/2013	Logue et al.
D370,625 S	6/1996	Kelsey et al.	D689,374 S	9/2013	Logue et al.
D372,124 S	7/1996	Dammers	D689,778 S	9/2013	Logue et al.
D372,867 S	8/1996	Lambelet et al.	D691,465 S	10/2013	O'Brien
D382,474 S	8/1997	Malmborg et al.	D691,856 S	10/2013	Dabney-Wiggs
5,740,717 A	4/1998	Sowden et al.	8,544,650 B2	10/2013	Williams-Hartman
D404,641 S	1/1999	Kelsey et al.	8,550,248 B1	10/2013	Busen
D411,445 S	6/1999	Anderson et al.	8,556,077 B1	10/2013	Hanley
D414,106 S	9/1999	Anderson et al.	8,561,798 B2	10/2013	Hession
D414,409 S	9/1999	Sanfilippo et al.	8,567,606 B2	10/2013	Bellamah et al.
6,082,544 A	7/2000	Romick	8,573,403 B2	11/2013	Stevens et al.
6,138,830 A	10/2000	Muggli	8,579,106 B2	11/2013	Naik et al.
D434,558 S	12/2000	Brady et al.	8,584,857 B2	11/2013	Ozawa et al.
6,273,260 B1	8/2001	ColDepietro et al.	D694,904 S	12/2013	Banes et al.
D448,048 S	9/2001	Brown, III	8,602,218 B2	12/2013	Grosskopf
D457,246 S	5/2002	Mazel et al.	8,607,982 B2	12/2013	Jones
6,443,307 B1	9/2002	Burrige	8,607,983 B2	12/2013	Niven et al.
6,516,949 B2	2/2003	Fuller et al.	D697,095 S	1/2014	Chan
6,622,856 B2	9/2003	Gallo et al.	8,627,957 B2	1/2014	Ziemba et al.
D480,958 S	10/2003	Mazel et al.	8,640,917 B2	2/2014	Kracke
6,659,280 B2	12/2003	Paliotta et al.	8,672,134 B2	3/2014	Sprada et al.
6,679,382 B1	1/2004	Kancsar et al.	8,740,003 B2	6/2014	Elliott
6,793,077 B1	9/2004	Kancsar et al.	8,746,454 B2	6/2014	Doucet et al.
6,896,139 B2	5/2005	Kancsar et al.	8,752,704 B2	6/2014	Leon Alonso et al.
6,997,320 B1	2/2006	Kancsar et al.	8,757,381 B2	6/2014	Bouthiette
D518,737 S	4/2006	Zalzal et al.	D708,760 S	7/2014	Smeja
7,063,211 B2	6/2006	Williams-Hartman et al.	D708,761 S	7/2014	Smeja
D525,777 S	8/2006	Priebe et al.	D708,762 S	7/2014	Smeja
D526,478 S	8/2006	Priebe et al.	D711,219 S	8/2014	Palsson et al.
7,126,879 B2	10/2006	Snyder	D713,051 S	9/2014	Smeja
7,188,728 B2	3/2007	Williams-Hartman	D723,279 S	3/2015	Wax
D546,198 S	7/2007	Currie et al.	2003/0034271 A1	2/2003	Burrige
D558,603 S	1/2008	Priebe et al.	2003/0042167 A1	3/2003	Balz et al.
7,360,652 B2	4/2008	Arnold	2003/0164380 A1	9/2003	Taneja et al.
D574,665 S	8/2008	James	2006/0163110 A1	7/2006	Adler et al.
7,448,496 B2	11/2008	Williams-Hartman	2007/0185615 A1	8/2007	Bossi et al.
D600,503 S	9/2009	Ragsdale et al.	2009/0038982 A1	2/2009	Doucet et al.
7,641,050 B2	1/2010	Klatt et al.	2009/0242451 A1	10/2009	Kessler
7,665,610 B2	2/2010	Williams-Hartman et al.	2009/0301924 A1	12/2009	Rondeau
7,696,236 B2	4/2010	Bradford	2011/0215022 A1	9/2011	Sack et al.
D619,257 S	7/2010	Meschenmoser et al.	2012/0248005 A1	10/2012	Bergey
D620,260 S	7/2010	Emmert	2012/0261275 A1	10/2012	Intini
7,748,535 B2	7/2010	Grosskopf	2013/0008825 A1	1/2013	McArthur et al.
D622,158 S	8/2010	Proulx	2013/0193029 A1	8/2013	Weston et al.
7,767,700 B2	8/2010	Bradford et al.	2013/0220870 A1	8/2013	Grosskopf
7,784,250 B2	8/2010	Grosskopf	2013/0220871 A1	8/2013	Bradford
			2013/0233756 A1	9/2013	Weston et al.
			2013/0256183 A1	10/2013	Ingraham
			2013/0281960 A1	10/2013	Hanley
			2013/0306511 A1	11/2013	Branyon et al.

(56)

References Cited

U.S. PATENT DOCUMENTS

2014/0001194 A1 1/2014 Pipes et al.
 2014/0027340 A1 1/2014 Hession
 2014/0027341 A1 1/2014 Ludwig et al.
 2014/0083900 A1 3/2014 Ziemba et al.
 2014/0171436 A1 6/2014 Kamen et al.
 2014/0183095 A1 7/2014 Choubey et al.
 2014/0209498 A1 7/2014 Stevens
 2014/0214438 A1 7/2014 Ahmadi
 2014/0216968 A1 8/2014 Wagner et al.
 2014/0216977 A1 8/2014 Bowers et al.

FOREIGN PATENT DOCUMENTS

AU 346153 S 1/2013
 AU 348282 S 5/2013
 AU 357121 S 8/2014
 AU 359486 S 12/2014
 CA 114356 3/2008
 CA 120646 3/2014
 CL 36012012 12/2012
 CL 8902013 4/2013

CL 8912013 4/2013
 EP 1211191 A1 6/2002
 EP 1481914 A1 12/2004
 WO 2005120984 A1 12/2005
 WO 2010015638 A1 2/2010
 WO 2014057967 A1 4/2014
 WO 2014085625 A1 6/2014

OTHER PUBLICATIONS

Office Action mailed Apr. 22, 2014 for Japanese Design Application No. 2014-7622.
 Office Action mailed Apr. 22, 2014 for Japanese Design Application No. 2014-7623.
 United States Patent Office U.S. Appl. No. 29/424,276, filed Jun. 10, 2012, Akana et al.
 Notice of Allowance and Fees Due mailed Sep. 30, 2015 for U.S. Appl. No. 14/323,701, filed Jul. 3, 2014.
 Chilean Patent Office Action for Application No. 2014-000864 dated Sep. 21, 2015 (8 pages), Jul. 10, 2013.
 Chilean Patent Office Action for Application No. 2014-000866 dated Sep. 21, 2015 (8 pages), Jul. 10, 2013.
 Chilean Patent Office Action for Application No. 2014-002839 dated Sep. 28, 2015 (6 pages), Oct. 21, 2014.

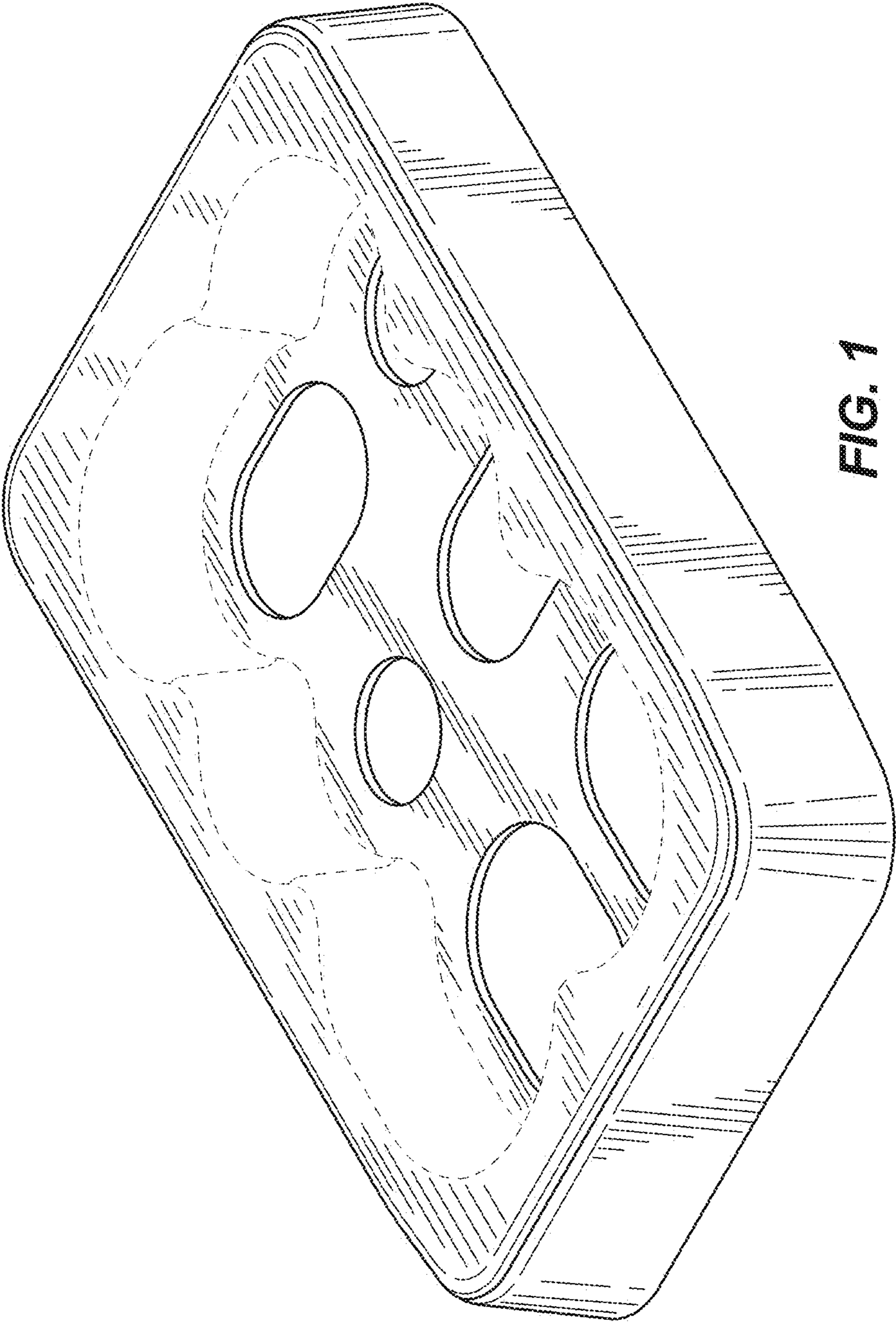

FIG. 1

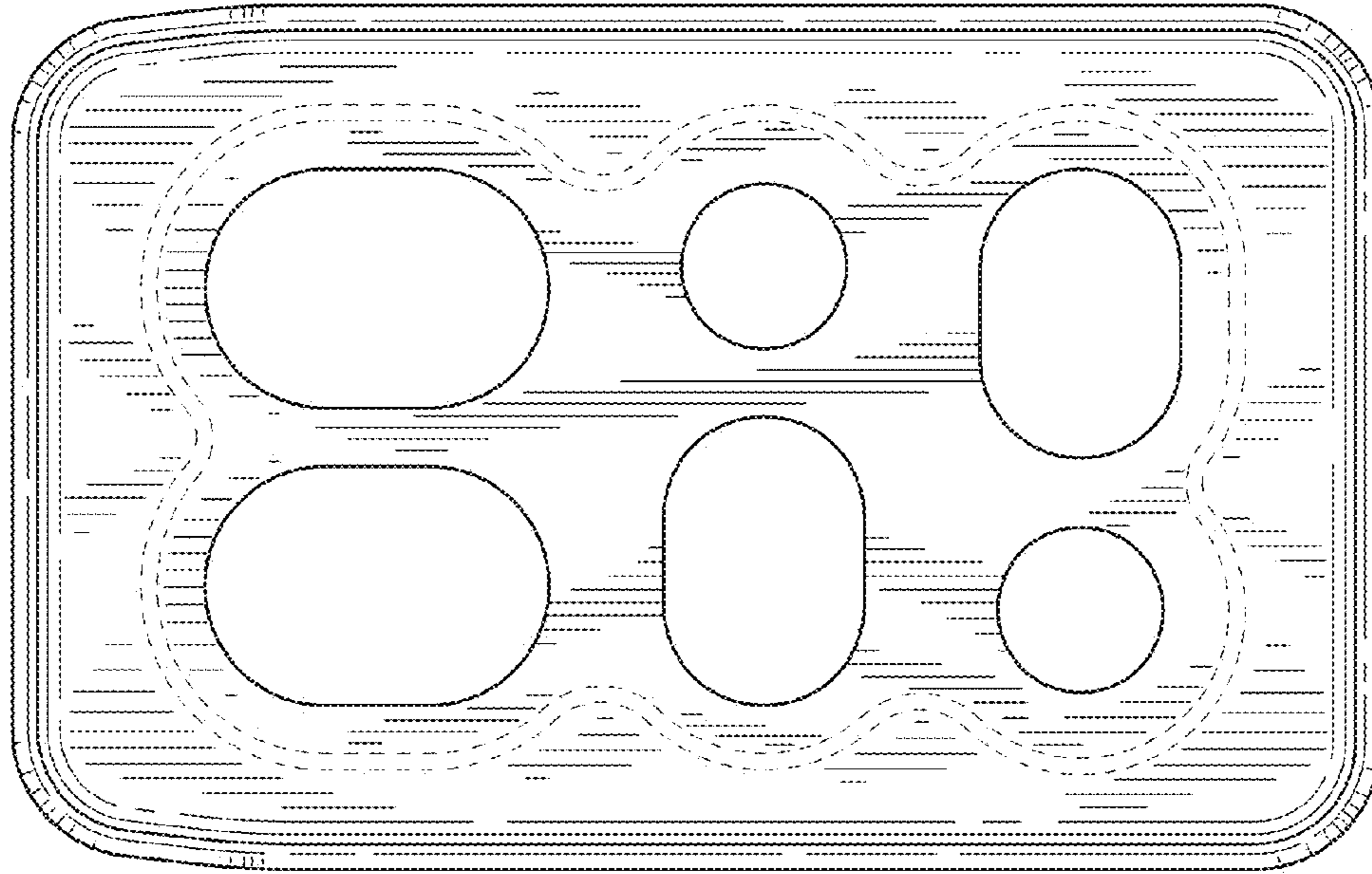

FIG. 2

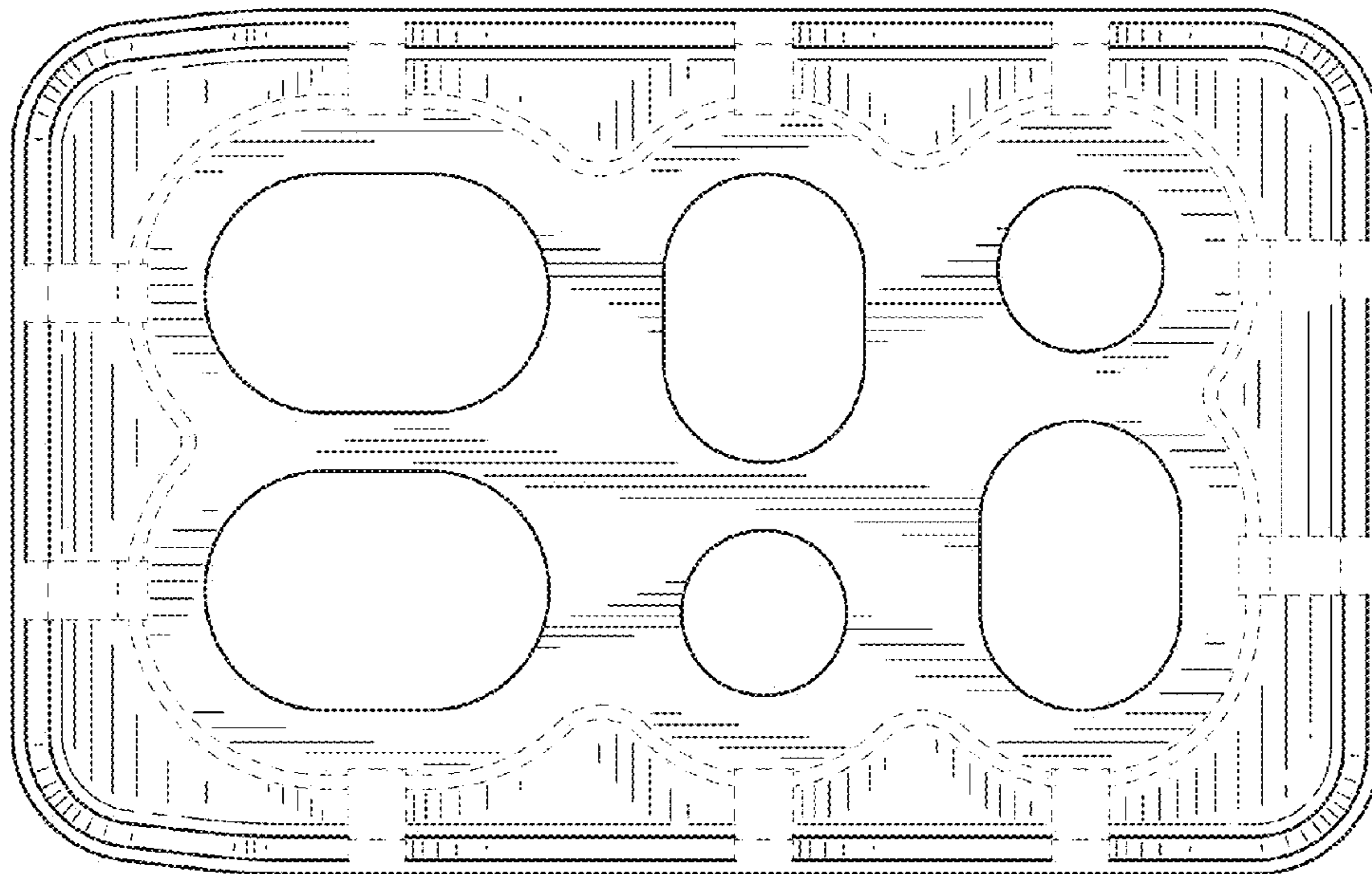

FIG. 3

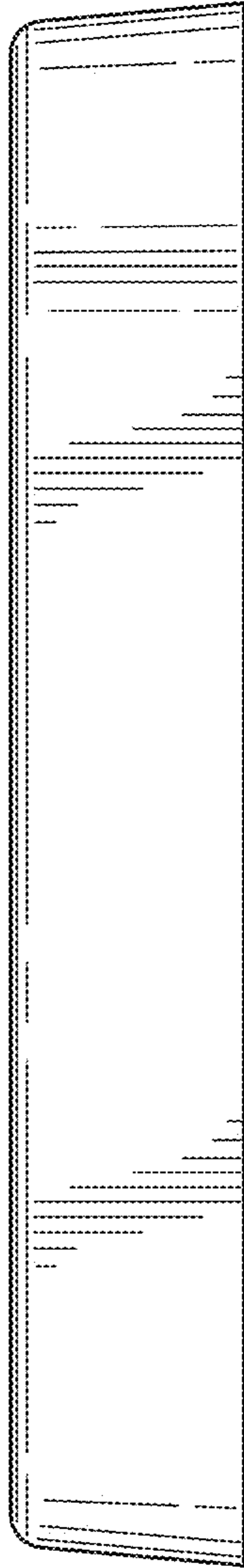

FIG. 4

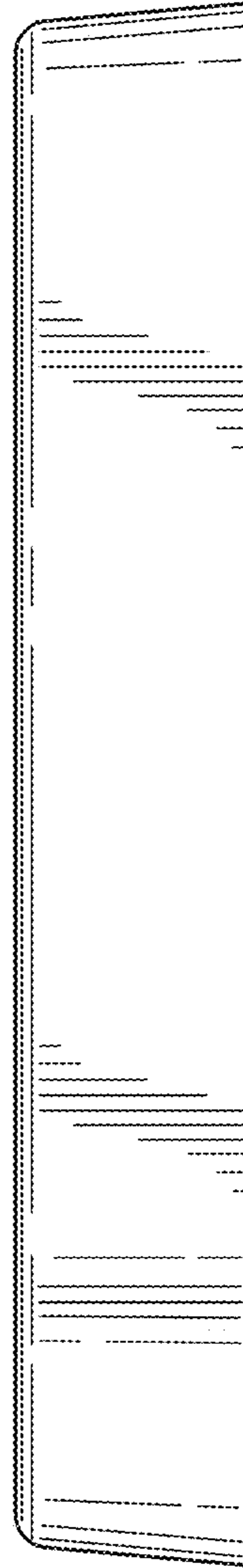

FIG. 5

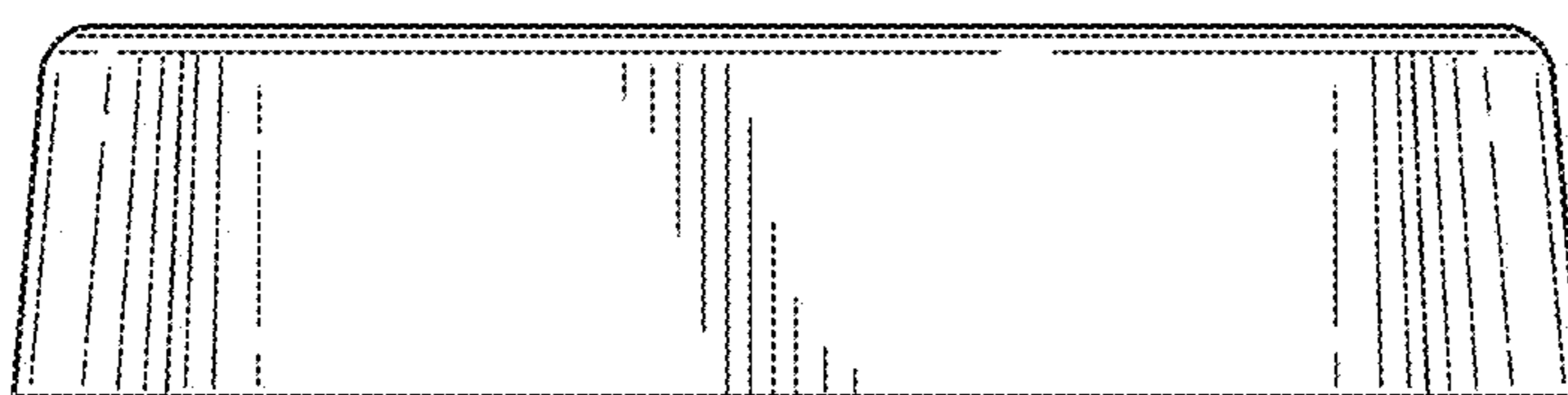

FIG. 6

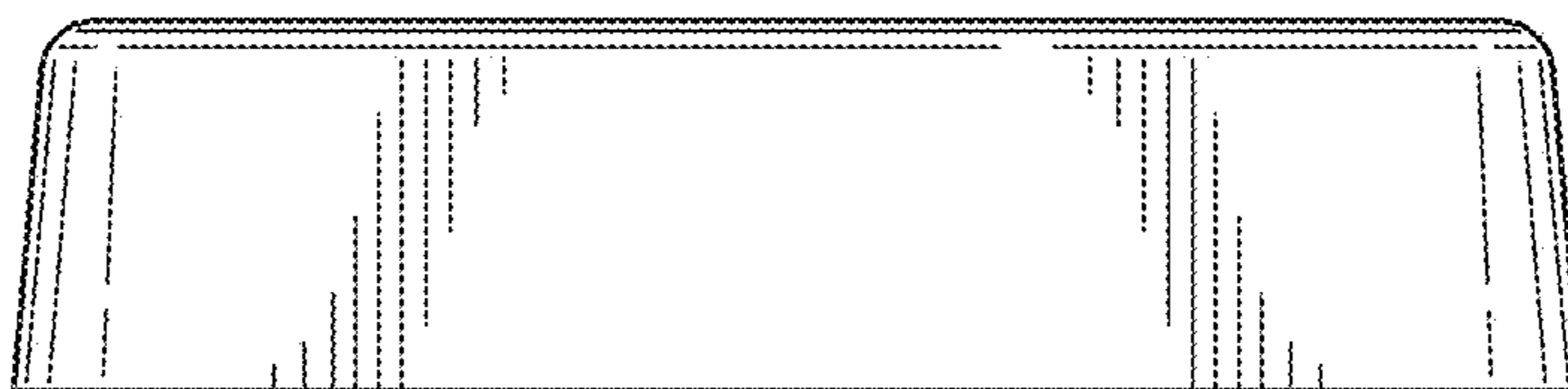

FIG. 7