



US00D747559S

(12) **United States Design Patent**
Faulkner

(10) **Patent No.:** **US D747,559 S**
(45) **Date of Patent:** **** Jan. 12, 2016**

(54) **ATHLETIC GLOVE WITH ENHANCED GRIP**

(71) Applicant: **Jerome D. Faulkner**, Anoka, MN (US)

(72) Inventor: **Jerome D. Faulkner**, Anoka, MN (US)

(**) Term: **14 Years**

(21) Appl. No.: **29/497,571**

(22) Filed: **Jul. 25, 2014**

(51) **LOC (10) Cl.** **02-06**

(52) **U.S. Cl.**
USPC **D29/117.1; D2/619**

(58) **Field of Classification Search**
USPC D2/610, 613, 615, 616, 617, 623;
D21/807; D29/113, 114, 115, 116.2,
D29/117.1, 122, 123; D32/40, 41, 42, 43;
2/16, 19, 21, 159, 160, 161.1, 161.2,
2/161.5, 163; 441/56, 57, 58
CPC A41D 19/00; A41D 19/0017; A63B 31/02
See application file for complete search history.

(56) **References Cited**

U.S. PATENT DOCUMENTS

2,258,999	A *	10/1941	Nunn	2/159
2,309,516	A *	1/1943	Lindfelt	2/161.2
2,554,991	A *	5/1951	Kramer	2/159
3,257,673	A *	6/1966	Rademacher	441/57
D236,044	S *	7/1975	Carter	D29/113
5,117,508	A *	6/1992	Gunter	2/160
D329,926	S *	9/1992	Winder	D29/113
D364,951	S *	12/1995	Martello	D21/807
D382,087	S *	8/1997	Arshed	D2/617
D393,934	S *	4/1998	Harvey	D29/113
D404,888	S *	2/1999	Arredondo, Jr.	D29/113
5,881,388	A	3/1999	Pratt	
6,081,928	A	7/2000	Bourne	
D469,581	S *	1/2003	Austin	D29/117.1
6,505,349	B1 *	1/2003	Logan et al.	2/158
6,675,392	B2	1/2004	Albert	
6,691,315	B1 *	2/2004	Clarke et al.	2/20
6,745,403	B2	6/2004	Sajovic	
6,845,519	B2 *	1/2005	Garneau	2/161.1

7,100,212	B2	9/2006	Jaeger	
D529,663	S *	10/2006	Budd	D29/114
7,210,172	B2 *	5/2007	Adams, Jr.	2/163
D640,856	S *	7/2011	Rose	D2/614
D658,335	S *	4/2012	Felder, Sr.	D29/113
8,313,471	B2 *	11/2012	Hendricks	604/292
8,413,264	B1	4/2013	Harrold	
8,443,462	B1	5/2013	Eugene	
8,522,363	B2	9/2013	Hassan et al.	
D705,493	S *	5/2014	Steinberg et al.	D29/117.2
2006/0174395	A1 *	8/2006	Mayo	2/160
2011/0252537	A1	10/2011	Burns	
2012/0204319	A1	8/2012	Gambordella	
2012/0222186	A1	9/2012	Vena	
2012/0284900	A1 *	11/2012	Zichelle	2/160
2013/0239291	A1	9/2013	Harris	
2015/0047096	A1 *	2/2015	Smith et al.	2/160

* cited by examiner

Primary Examiner — Karen E. Eldridge Powers
Assistant Examiner — Jasmine Mlinarcik
(74) *Attorney, Agent, or Firm* — Robert C. Montgomery;
Montgomery Patent & Design, LP.

(57) **CLAIM**

The ornamental design for an athletic glove with enhanced grip, as shown and described.

DESCRIPTION

FIG. 1 is an upper perspective view of an athletic glove with enhanced grip, as shown and described; FIG. 2 is a front elevation view thereof; FIG. 3 is a rear elevation view thereof; FIG. 4 is a left-side elevation view thereof; FIG. 5 is a right-side elevation thereof; and, FIG. 6 is a top plan view thereof, the bottom plan view being a mirror image thereof. The athletic glove as described and illustrated herein is understood to accommodate either a left hand or a right hand of a user. The broken line depictions illustrate a fastening means of the glove and form no part of the claimed design.

1 Claim, 6 Drawing Sheets

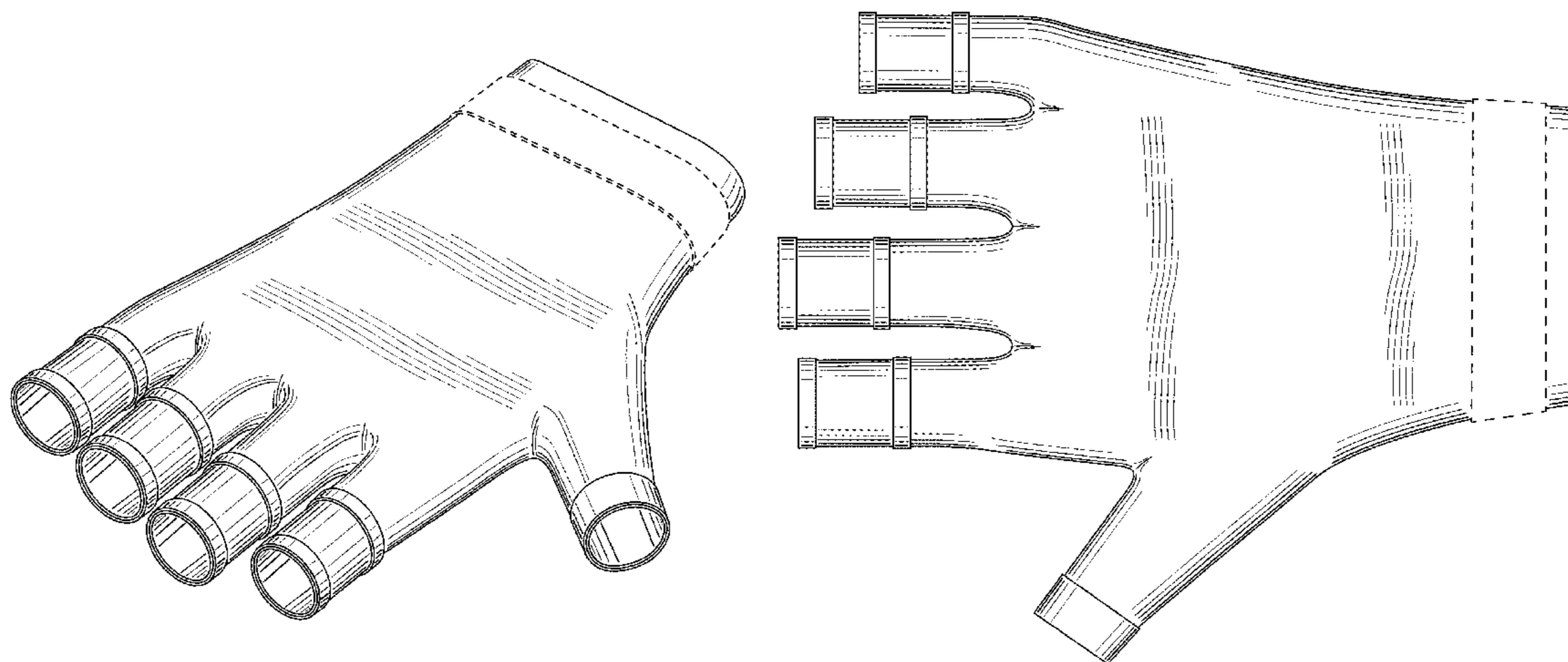

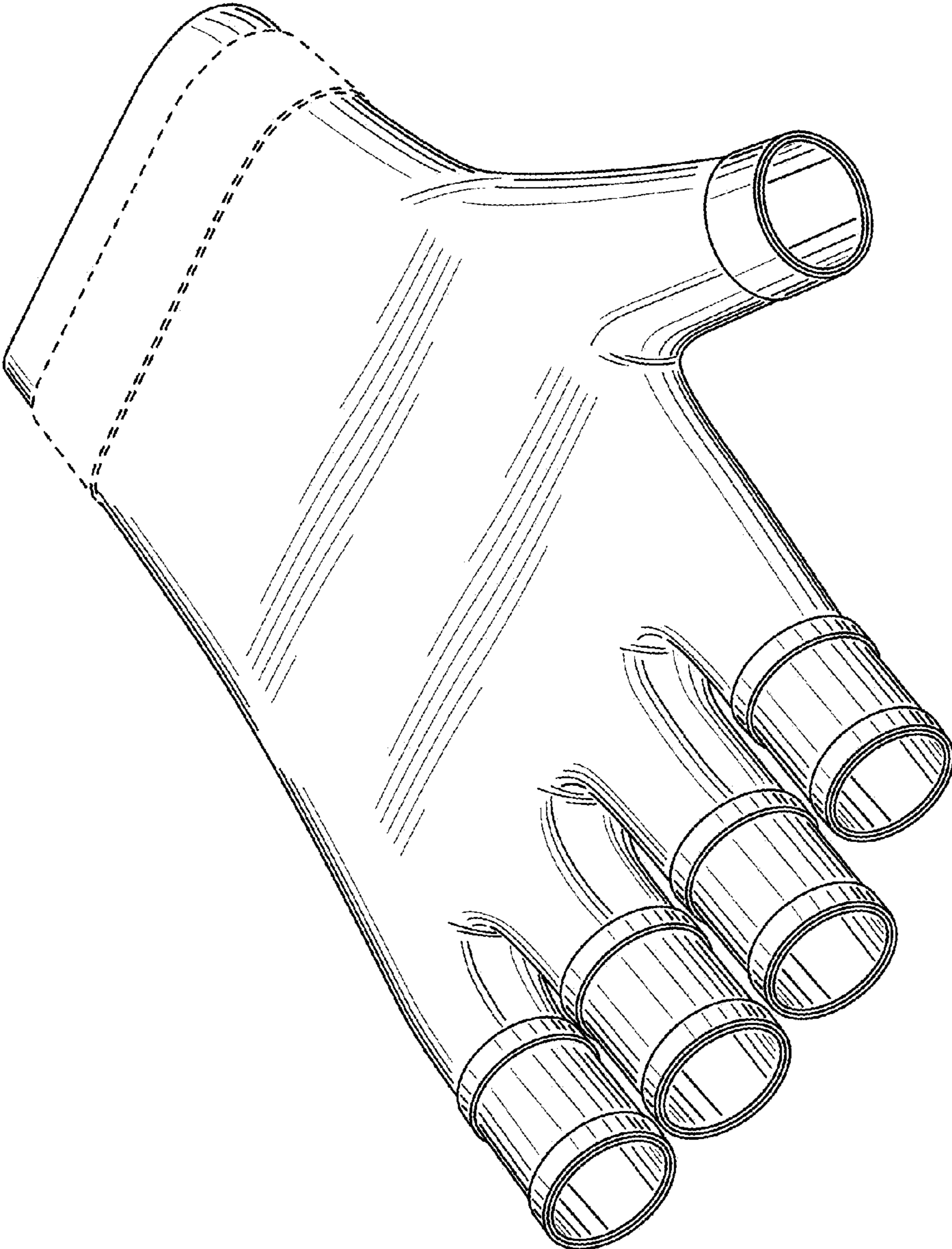

FIG. 1

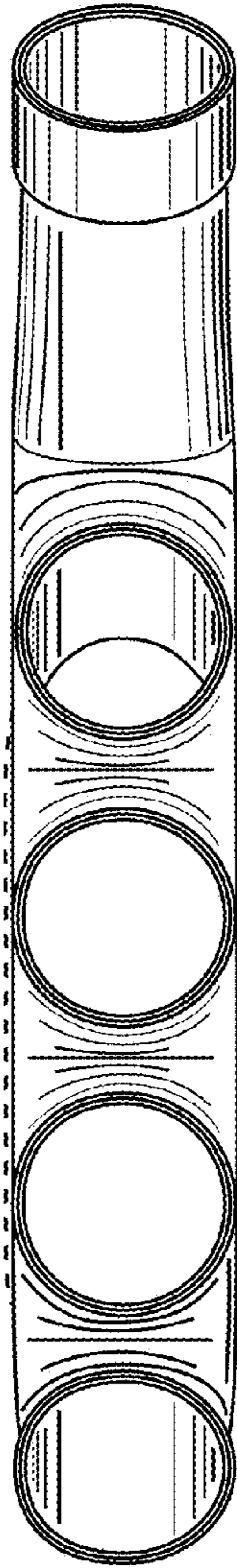

FIG. 2

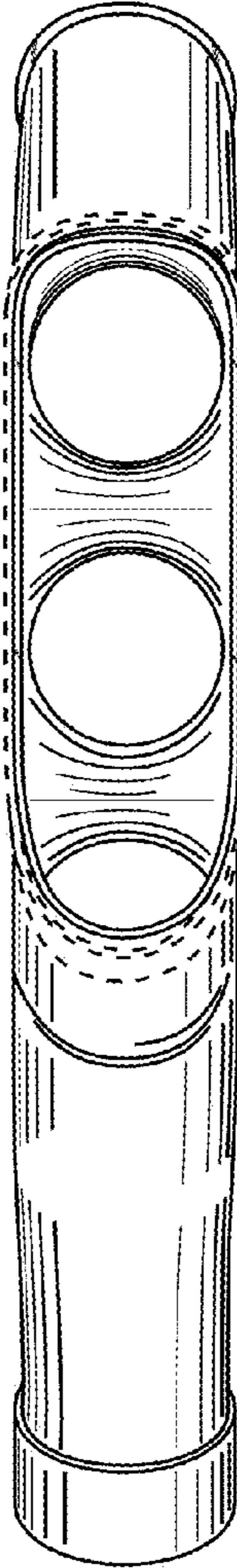

FIG. 3

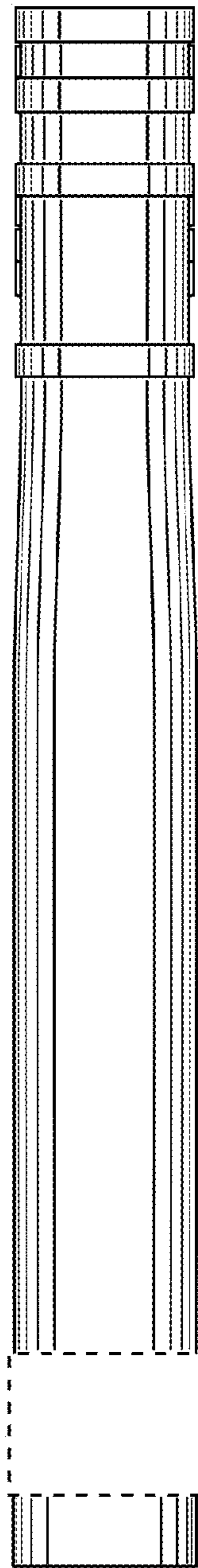

FIG. 4

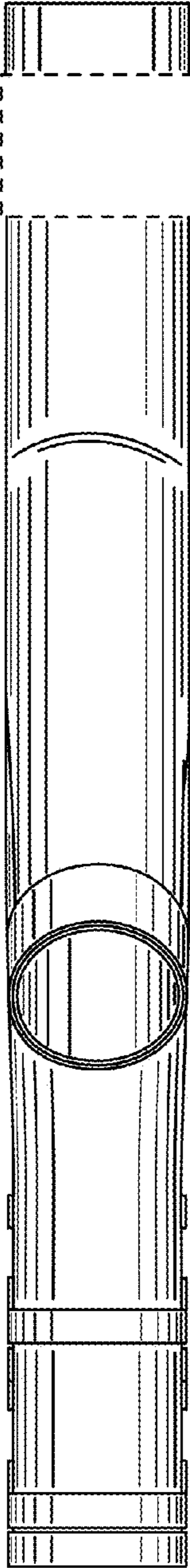

FIG. 5

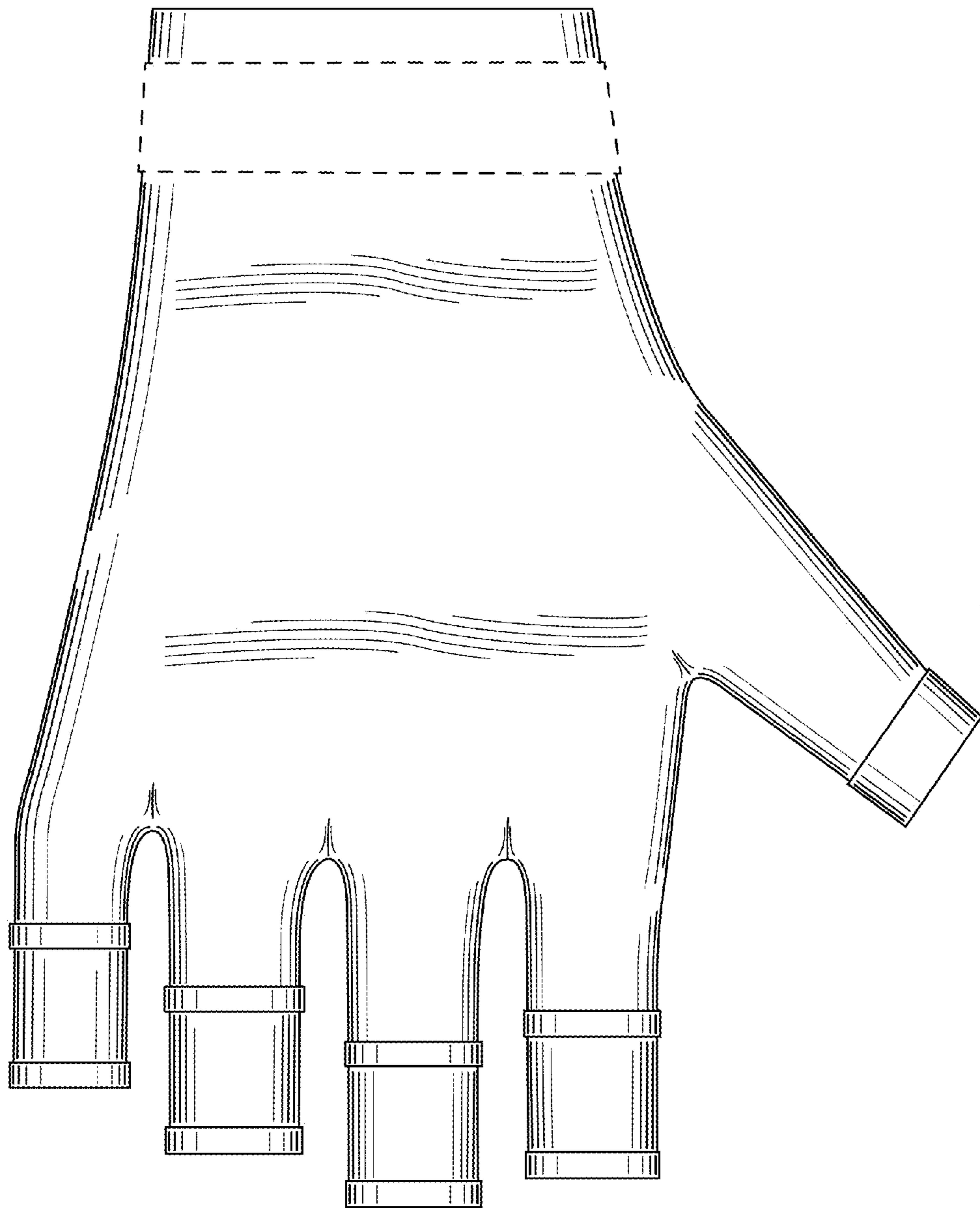

FIG. 6